



User's Manual

RS232/RS422/RS485

Industrial Serial Device Server

- ▶ ICS-2100T / ICS-2105AT/
ICS-2102T / ICS-2102TS/
ICS-2200T / ICS-2400T



Trademarks

Copyright © PLANET Technology Corp. 2020.

Contents are subject to revision without prior notice.

PLANET is a registered trademark of PLANET Technology Corp. All other trademarks belong to their respective owners.

Disclaimer

PLANET Technology does not warrant that the hardware will work properly in all environments and applications, and makes no warranty and representation, either implied or expressed, with respect to the quality, performance, merchantability, or fitness for a particular purpose. PLANET has made every effort to ensure that this User's Manual is accurate; PLANET disclaims liability for any inaccuracies or omissions that may have occurred.

Information in this User's Manual is subject to change without notice and does not represent a commitment on the part of PLANET. PLANET assumes no responsibility for any inaccuracies that may be contained in this User's Manual. PLANET makes no commitment to update or keep current the information in this User's Manual, and reserves the right to make improvements to this User's Manual and/or to the products described in this User's Manual, at any time without notice.

If you find information in this manual that is incorrect, misleading, or incomplete, we would appreciate your comments and suggestions.

FCC Warning

This equipment has been tested and found to comply with the limits for a Class A digital device, pursuant to Part 15 of the FCC Rules. These limits are designed to provide reasonable protection against harmful interference when the equipment is operated in a commercial environment. This equipment generates, uses, and can radiate radio frequency energy and, if not installed and used in accordance with the Instruction manual, may cause harmful interference to radio communications. Operation of this equipment in a residential area is likely to cause harmful interference in which case the user will be required to correct the interference at his own expense.

CE Mark Warning

This equipment is compliant with Class A of CISPR 32. In a residential environment this equipment may cause radio interference.

Energy Saving Note of the Device

This power required device does not support Standby mode operation. For energy saving, please remove the power cable to disconnect the device from the power circuit. In view of saving the energy and reducing the unnecessary power consumption, it is strongly suggested to remove the power connection for the device if this device is not intended to be active.

WEEE Warning



To avoid the potential effects on the environment and human health as a result of the presence of hazardous substances in electrical and electronic equipment, end users of electrical and electronic equipment should understand the meaning of the crossed-out wheeled bin symbol. Do not dispose of WEEE as unsorted municipal waste and have to collect such WEEE separately.

Revision

PLANET ICS-2x00T Series User's Manual

Model: ICS-2100T / ICS-2105AT / ICS-2200T / ICS-2400T

Revision: 1.0 (August, 2020)

Part No: EM-ICS -2x00T_v1.1

TABLE OF CONTENTS

1. INTRODUCTION	5
1.1 Packet Contents	5
1.2 Product Description	6
1.3 How to Use This Manual	10
1.4 Product Features	11
1.5 Product Specifications	13
2. INSTALLATION	16
2.1 Hardware Description	16
2.1.1 Front Panel	16
2.1.2 Front Panel	18
2.1.3 LED Indications	19
2.1.4 Wiring the Power Inputs	20
2.1.5 Serial Port Pin Define	21
2.2 Installing the Industrial Serial Server	22
2.2.1 Installation Steps	22
2.2.2 DIN-rail Mounting	23
2.2.3 Wall Mount Plate Mounting	25
3. INDUSTRIAL SERIAL SERVER MANAGEMENT	26
3.1 Requirements	26
3.2 Web Management	27
3.2.1 Logging in to the Industrial Serial Server	27
3.3 Remote Management	29
3.4 PLANET Smart Discovery Utility	30
4. WEB CONFIGURATION	32
4.1 Main Web Page	35
4.2 System	36
4.2.1 System	36
4.2.2 Port	38
4.2.3 Device	39
4.2.4 Time	39
4.2.5 Console	40
4.2.6 Fault Alarm	40
4.2.7 Digital Input and Output	41

4.3 Accessible IP	42
4.4 Network	43
4.5 Port Config.....	45
4.5.1 Serial setup.....	46
4.5.2 Operation mode.....	47
4.5.2.1 Disable mode	47
4.5.2.2 Remote Pair Master/Slave mode.....	48
4.5.2.3 RF2217 mode.....	50
4.5.2.4 Serial Telnet mode.....	51
4.5.2.5 TCP Server mode.....	54
4.5.2.6 TCP Client mode	57
4.5.2.7 UDP mode.....	59
4.5.2.8 Virtual COM mode	61
4.5.2.9 Modbus Converter Server mode	64
4.5.2.10 Modbus Converter Client mode.....	66
4.6 SNMP Setup.....	68
4.7 Maintenance	69
4.7.1 Change Password	69
4.7.2 Load Default	69
4.7.3 Firmware Update	70
4.8 Save and Restart.....	71
5. SOFTWARE VCOM UTILITY.....	72
5.1 Installing the VCOM Utility.....	72
5.2 Search Devices	74
5.3 Virtual COM.....	75

1. INTRODUCTION





Thank you for purchasing PLANET ICS-2100T Industrial Serial Device Server series. "Industrial Serial Server" is used as an alternative name in this Quick Installation Guide.

ICS-2100T	IP30 Industrial 1-Port RS232/RS422/RS485 Serial Device Server (1 x 10/100TX, -40~75 degrees C)
ICS-2102T	IP30 Industrial 1-Port RS232/RS422/RS485 Serial Device Server (1 x 100FX SC, 2km, -40~75 degrees C)
ICS-2102TS	IP30 Industrial 1-Port RS232/RS422/RS485 Serial Device Server (1 x 100FX SC, 30km, -40~75 degrees C)
ICS-2105AT	IP30 Industrial 1-Port RS232/RS422/RS485 Serial Device Server (1 x 100FX SFP, -40~75 degrees C)
ICS-2200T	Industrial 2-Port RS232/RS422/RS485 Serial Device Server
ICS-2400T	Industrial 4-Port RS232/RS422/RS485 Serial Device Server

"Industrial Serial Server" mentioned in this Guide refers to the above models

1.1 Packet Contents

Open the box of the Industrial Serial Server and carefully unpack it. The box should contain the following items:

<p>The Industrial Serial Server x 1</p> 	<p>User's Manual x 1</p> 
<p>Wall Mounting Kit x 1</p> 	<p>Dust Cap (RJ45 / SFP)</p> 
<p>DIN-rail Bracket w/Screws x 1</p> 	

If any of these are missing or damaged, please contact your dealer immediately; if possible, retain the carton including the original packing material, and use them again to repack the product in case there is a need to return it to us for repair.

1.2 Product Description

Cost-effective Solution for RS232/422/485 Serial-to-Industrial Ethernet Application

PLANET ICS-2x00T Serial Device Server series is specially designed to convert RS232, RS422 or RS485 serial communication to Industrial Fast Ethernet networking so as to extend the network distance efficiently and inexpensively. There are one/two 10/100BASE-TX RJ45 ports available in the ICS-2x00T series for your network needs. The ICS-2x00T series is a time-saving and cost-effective solution for users and system integrators to quickly transform their serial devices into the Ethernet network with no need of replacing the existing serial devices and software system.



Legacy Serial Devices are Making Further Headway in an IoT Era

IPv4 / IPv6 | Web Management | VCOM Utility

Redundant Power AC/DC | 10 Operation Modes | 75°C / -40°C

Ethernet **TCP/IP** Protocol | Serial Interface

RS232 | RS485 | RS422

ICS-2100T ◀ | ▶ ICS-2105AT



Integrate Legacy Serial Devices into IoT

IPv4 / IPv6 | Web Management | VCOM Utility

DI/DO | Isolation | 75°C / -40°C

Ethernet **TCP/IP** Protocol | Serial Interface

RS232 | RS485 | RS422

Convert Multiple Serial Devices to IP Networking

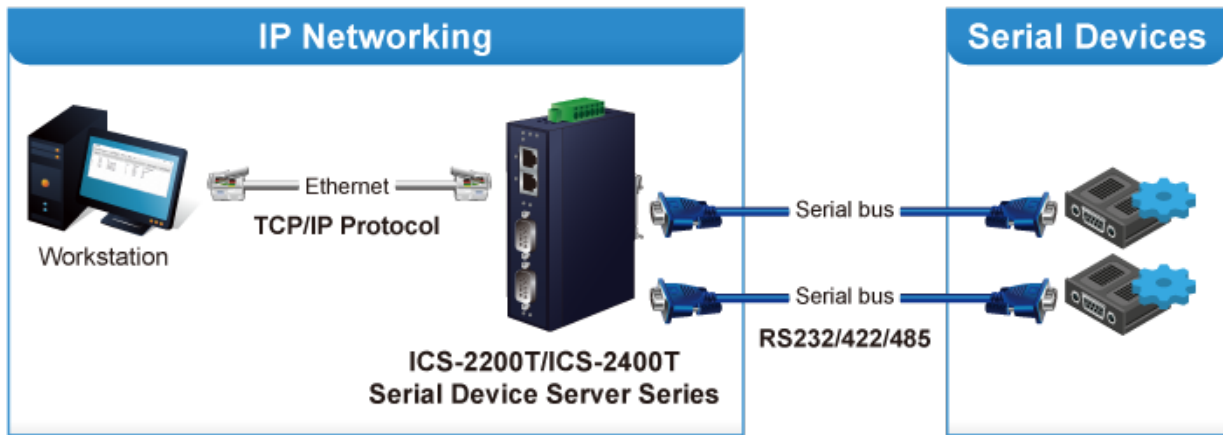

Remote Management

As the ICS-2x00T series provides an easy serial-to-Ethernet connectivity and connection to a TCP/IP network, the remote network system can thus be managed efficiently via its Web, Telnet and VCOM management interfaces. It supports both application and serial operation modes for alarm or IP address connection, which saves the network administrator's time in detecting and locating network problems without visual inspection of the cabling and devices. Multiple connection options are available for large networking environment as well.



Stable Performance under Difficult Environments

The ICS-2x00T series provides a high level of immunity against electromagnetic interference and heavy electrical surges which are usually found on plant floors or in curbside traffic control cabinets. Its operating temperature ranging from -40 to 75 degrees C allows the ICS-2x00T series to be placed in almost any difficult environment.

The ICS-2x00T series with the compact IP30-/IP40-rated metal case allows either DIN-rail or wall mounting for efficient use of cabinet space. The ICS-2x00T series also provides an integrated power supply source with a wide range of voltages (12 to 48V DC) ideally suitable for worldwide operation with high availability applications requiring dual or backup power inputs.

Dual Power Input for High Availability Network System

The ICS-2x00T series features a strong dual power input system with wide-ranging voltages (12V~48V DC or 9 to 48V DC / 24V AC) incorporated into customer's automation network to enhance system reliability and uptime. In the example below, when Power Supply 1 fails to work, the hardware failover function will be activated automatically to keep powering the ICS-2x00T series via Power Supply 2 without any break of operation.

Non-stop Ethernet Service with Dual Power Input & Auto Failover

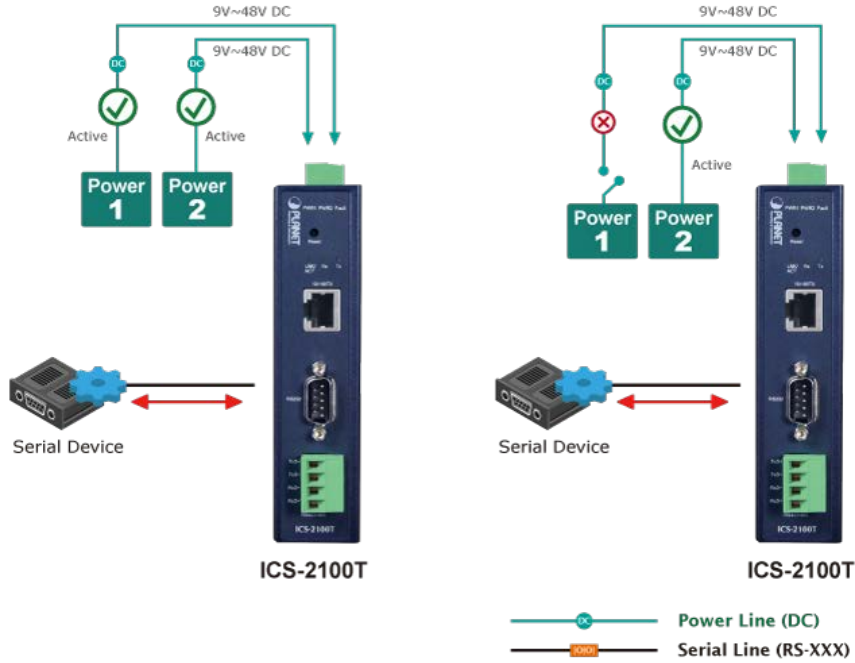

Non-stop Ethernet Service with Dual Power Input & Auto Failover

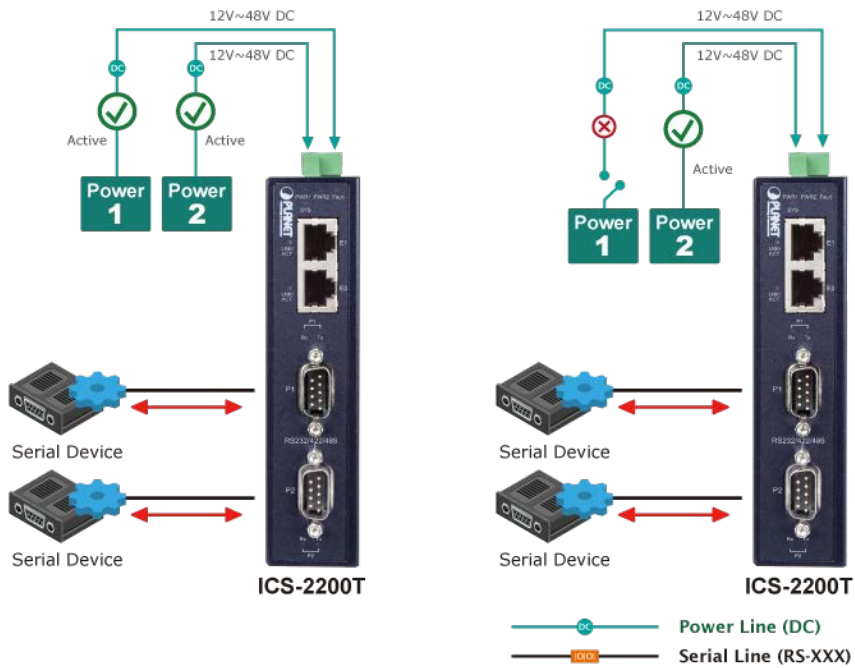

Effective Alarm Alert for Better Protection

The ICS-2x00T series comes with a Fault Alarm feature which can alert the users when there is something wrong with the Serial Device Server. With this ideal feature, the users would not have to waste time finding where the problem is. It will help to save time and human resource. The ICS-2x00T series provides event alert function to help to diagnose the abnormal device owing to whether or not there is a break of the network connection, or the rebooting response.

Fault Alarm Feature

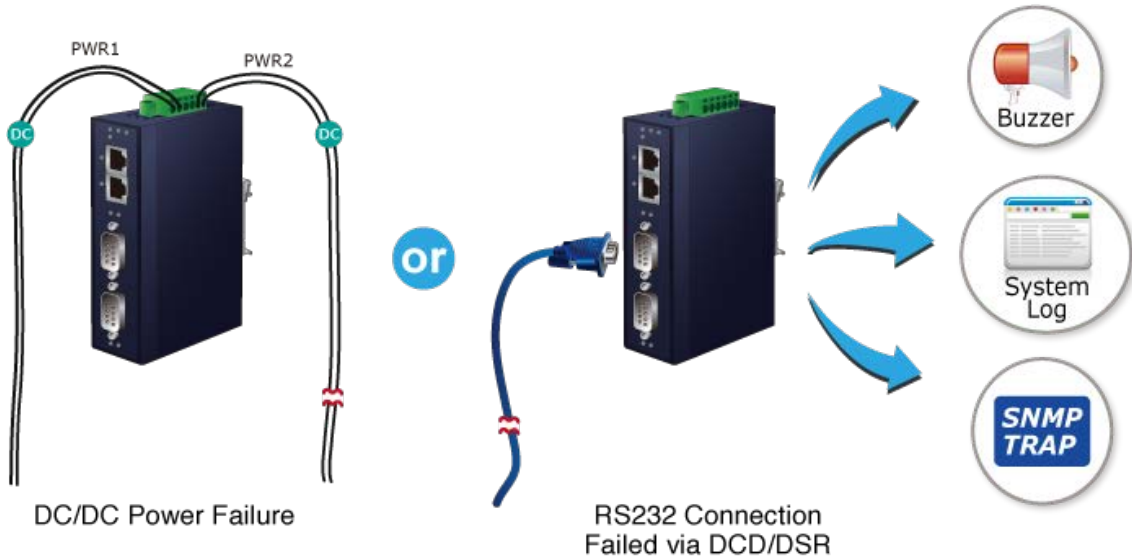

Digital Input and Digital Output for External Alarm (ICS-2400T only)

With digital input and digital output on its front panel, an external alarm can help users via the digital input to detect and log external device status (such as door intrusion detector), and then immediately send an event alarm to the administrator. The digital output can be used to alarm the administrator if the ICS-2400T serial port shows connection failure or power failure.

1.3 How to Use This Manual

This User's Manual is structured as follows:

Section 2, INSTALLATION

It explains the functions of the ICS-2X00T and how to physically install the ICS-2X00T.

Section 3, INDUSTRIAL SERIAL SERVER MANAGEMENT

The chapter explains how to manage the ICS-2X00T in different ways.

Section 4, WEB CONFIGURATION

It describes how to configure by web interface.

Section 5, SOFTWARE VCOM UTILITY

It describes how to use software VCOM in the Virtual COM mode.

1.4 Product Features

➤ **Serial Interface**

- One/Two/four DB9 interfaces support RS232, 2-wire RS485, 4-wire RS485 and RS422 operations
- Asynchronous serial data rates up to 921600bps
- Data mode including VCOM, RFC2217, TCP Server, TCP Client, UDP, Remote Pair and Serial Telnet modes

➤ **Ethernet Interface**

- One/Two **10/100BASE-TX RJ45** interfaces with auto MDI/MDI-X function or **100BASE-FX** SFP interface (ICS-2105AT)
- Ethernet ports support Ethernet switch or cascading operation for easy wiring

➤ **Management**

- IPv4 and IPv6 dual stack management
- Remote Management Interfaces
 - IP-based Web management
 - Telnet console management
 - Windows-based VCOM utility supports searching, monitoring and configuration setting
- IP NTP (Network Time Protocol) and DNS management
- Standard TCP/IP interface and versatile operation modes
- Software Protocol supports ARP, ICMP, TCP/IP, UDP, HTTP server, DHCP client, Telnet server/client
- Serial Operation mode selected via management interface
- Pair Connection mode for connecting two serial devices over a network
- Allows a maximum of 4 hosts to be accessed in TCP client mode
- Firmware upgrade via HTTP protocol
- Accessible IP security control to prevent illegal users
- Event notification
 - Remote syslog server
 - SNMP trap
 - Built-in buzzer
 - Relay output alarm
 - Digital output (ICS-2400T only)
- DHCP client for IP address assignment
- PLANET Smart Discovery utility automatically finds the client devices on the network

➤ **Industrial Case and Installation**

- IP30 metal case
- IP40 metal case (ICS-2400T only)
- DIN-rail and wall-mount designs
- Redundant power design
 - 9 to 48V DC or 24V AC, redundant power with reverse polarity protection (ICS-2100T/2012T/2102TS/2105AT)

– 12 to 48V DC, redundant power with reverse polarity protection (ICS-2200T/2400T)

- Supports 6000 VDC Ethernet ESD protection
- -40 to 75 degrees C operating temperature
- Free fall, shock-proof and vibration-proof for industries
- Supports extensive LED indicators for network diagnosis
- Reset button for resetting to factory default

➤ **Digital Input and Digital Output (ICS-2400T only)**

- 2 digital inputs (DI)
- 2 digital outputs (DO)
- Integrate sensors into auto alarm system
- Transfer alarm to IP network via email and SNMP trap

1.5 Product Specifications

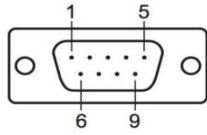
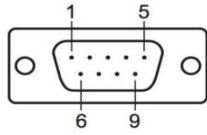
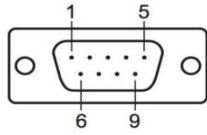
Product	ICS-2100T	ICS-2105AT	ICS-2102T ICS-2102TS	ICS-2200T	ICS-2400T																																										
Serial Interface																																															
Serial Ports	1 x DB9 male for RS232 1 x 4-pin Terminal block for RS422 / RS485			2 x DB9 male	4 x DB9 male																																										
Serial Standards	RS232 / 4-wire RS422 or RS485 / 2-wire RS485																																														
Baud Rate (Data Rate)	50bps to 921Kbps																																														
Data Bits	5, 6, 7, 8																																														
Parity Type	1, 1.5, 2																																														
Stop Bit	Odd, Even, None, Space, Mark																																														
Flow Control	RTS/CTS and DTR/DSR (RS232 only) XON/XOFF																																														
Signals	RS232: TxD, RxD, RTS, CTS, DTR, DSR, DCD, GND RS422: Tx+, Tx-, Rx+, Rx-, GND 4-wire RS485: Tx+, Tx-, Rx+, Rx-, GND 2-wire RS485: Data A (+), Data B (-), GND																																														
Pin Assignment	<table border="1" style="margin-left: auto; margin-right: auto;"> <thead> <tr> <th>Male DB9</th> <th>Pin</th> <th>RS232</th> <th>RS422 RS485-4W</th> <th>RS485-2W</th> </tr> </thead> <tbody> <tr> <td rowspan="9">  </td> <td>1</td> <td>DCD</td> <td>TxD+</td> <td>--</td> </tr> <tr> <td>2</td> <td>RxD</td> <td>TxD-</td> <td>--</td> </tr> <tr> <td>3</td> <td>TxD</td> <td>RxD-</td> <td>Data-</td> </tr> <tr> <td>4</td> <td>DTR</td> <td>RxD+</td> <td>Data+</td> </tr> <tr> <td>5</td> <td>GND</td> <td>GND</td> <td>GND</td> </tr> <tr> <td>6</td> <td>DSR</td> <td>--</td> <td>--</td> </tr> <tr> <td>7</td> <td>RTS</td> <td>--</td> <td>--</td> </tr> <tr> <td>8</td> <td>CTS</td> <td>--</td> <td>--</td> </tr> <tr> <td>9</td> <td>--</td> <td>--</td> <td>--</td> </tr> </tbody> </table>					Male DB9	Pin	RS232	RS422 RS485-4W	RS485-2W		1	DCD	TxD+	--	2	RxD	TxD-	--	3	TxD	RxD-	Data-	4	DTR	RxD+	Data+	5	GND	GND	GND	6	DSR	--	--	7	RTS	--	--	8	CTS	--	--	9	--	--	--
Male DB9	Pin	RS232	RS422 RS485-4W	RS485-2W																																											
	1	DCD	TxD+	--																																											
	2	RxD	TxD-	--																																											
	3	TxD	RxD-	Data-																																											
	4	DTR	RxD+	Data+																																											
	5	GND	GND	GND																																											
	6	DSR	--	--																																											
	7	RTS	--	--																																											
	8	CTS	--	--																																											
	9	--	--	--																																											
Ethernet Interface																																															
Ethernet Ports	1 x RJ45	1 x SFP	1 x SC	2 x RJ45	2 x RJ45																																										
Standard	10/100BASE-TX	100BASE-FX		10/100BASE-TX	10/100BASE-TX																																										
Distance	100m	2km to 120km, vary on SFP modules	ICS-2102T: 2km ICS-2102TS: 30km	100m	100m																																										
Switch Architecture	-	-	-	Store-and-Forward-																																											
Address Table	-	-	-	1K																																											
ESD Protection	6KV																																														
Surge Protection	2KV																																														
Hardware																																															
Installation	DIN-rail kit and wall-mount ear																																														
Enclosure	IP 30 metal				IP40 metal																																										
Dimensions (W x D x H)	32 x 97 x 135 mm				56 x 87 x 135 mm																																										
Weight	392g	390g	393g	477 g	625 g																																										
LED Indicators	System: Power 1, Power 2, Fault, SYS, I/O(ICS-2400T only) TP/SFP Port: Link/Active																																														

	Serial Port: Tx and Rx				
Power Requirements	9~48V DC / 24V AC, redundant power with reverse polarity protection			12~48V DC, redundant power with reverse polarity protection	
Power Consumption	Full Loading 9VDC: 0.35A (3.15 watts) 12VDC: 0.28A (3.36 watts) 24VDC: 0.12A (3 watts) 48VDC: 0.08A (3.84 watts)	Full Loading 9VDC: 0.44A (3.96 watts) 12VDC: 0.33A (4 watts) 24VDC: 0.17A (4.08 watts) 48VDC: 0.1A (4.8 watts)	Full Loading 9VDC: 0.44A (3.96 watts) 12VDC: 0.33A (4 watts) 24VDC: 0.17A (4.08 watts) 48VDC: 0.1A (4.8 watts)	Full Loading 12VDC: 0.326A (3.8 watts) 24VDC: 0.176A (4.2 watts) 48VDC: 0.114A (5.4 watts)	Full Loading 12VDC: 0.419A (5.1 watts) 24VDC: 0.227A (5.4 watts) 48VDC: 0.136A (6.5 watts)
Connector	Removable 6-pin terminal block for power input Pin 1/2 for Power 1, Pin 3/4 for fault alarm, Pin 5/6 for Power 2				
DI and DO	N/A			2 digital inputs: Level 0: -24V~2.1V (±0.1V) Level 1: 2.1V~24V (±0.1V) Input Load to 24V DC, 10mA max. 2 digital outputs: Open collector to 24V DC, 100mA max.	
Alarm	Provides one relay output for power failure Alarm relay current carry ability: 1A @ DC 24V				
Reset Button	< 5 sec: System reboot > 5 sec: Factory default				
Management					
Management Interfaces	Web management Telnet Console management Windows-based VCOM Utility management PLANET Smart Discovery Utility				
IP Version	IPv4 and IPv6				
Operation Mode	TCP Server TCP Client UDP Client Virtual COM RFC2217 Telnet Server Pair Connection – Remote (Slave)				

	Pair Connection – Local (Master) Modbus converter server / client	
Virtual COM Utility Platform Supports	Windows-based only: Windows XP Windows Server 2003 Windows 7 Windows Server 2008 Windows 8 (Must install the latest version of WinPcap) Windows Server 2012 (Must install the latest version of WinPcap) Windows 10	
Alert	System log / SNMP Trap	Built-in buzzer and RTC
Security	Allows maximum 4 accessible IP address hosts/ranges	
SNMP MIBs	RFC1213 MIB-II RFC1317 RS232-like MIB	
Standards Conformances		
Regulatory Compliance	FCC Part 15 Class A, CE Certification Class A	
Stability Testing	IEC60068-2-32 (Free fall) IEC60068-2-27 (Shock) IEC60068-2-6 (Vibration)	
Standards	IEEE 802.3 10BASE-T IEEE 802.3u 100BASE-TX/100BASE-FX IEEE 802.3x flow control and back pressure RFC 768 UDP RFC 793 TFTP RFC 791 IP RFC 792 ICMP RFC 854 Telnet RFC 958 NTP RFC 1591 DNS (client only) RFC 1908 SNMPv2c RFC 2068 HTTP RFC 2131 DHCP Client RFC 2732 Format for Literal IPv6 Addresses in URL's RFC 3315 DHCPv6 Client RFC 3513 IPv6 Addressing Architecture RFC 3596 DNSv6 RFC 4443 ICMPv6 EIA/TIA RS232/422/485	
Regulatory Approval	RoHS	
Environment		
Operating Temperature	-40 ~ 75 degrees C	
Storage Temperature	-40 ~ 85 degrees C	
Humidity	5 ~ 95% (non-condensing)	

2. INSTALLATION

This section describes the hardware features and installation of the Industrial Serial Servers' components on the desktop or rack. For easier management and control of the Industrial Serial Servers, familiarize yourself with its display indicators, and ports. Front panel illustrations in this chapter display the LED indicators. Before connecting any network device to the Industrial Serial Servers, please read this chapter completely.

2.1 Hardware Description

2.1.1 Front Panel

The front panels of the Industrial Serial Servers are shown in Figure 2-1-1.

Front Panels

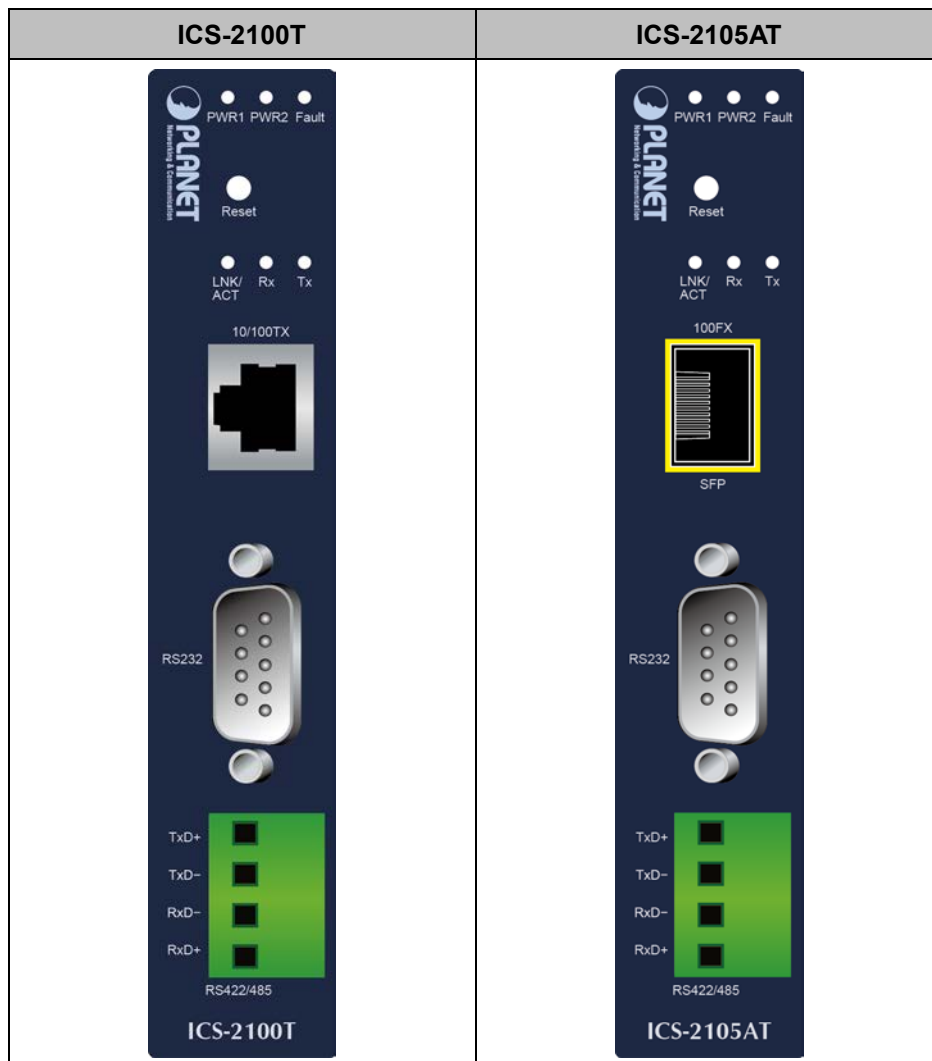

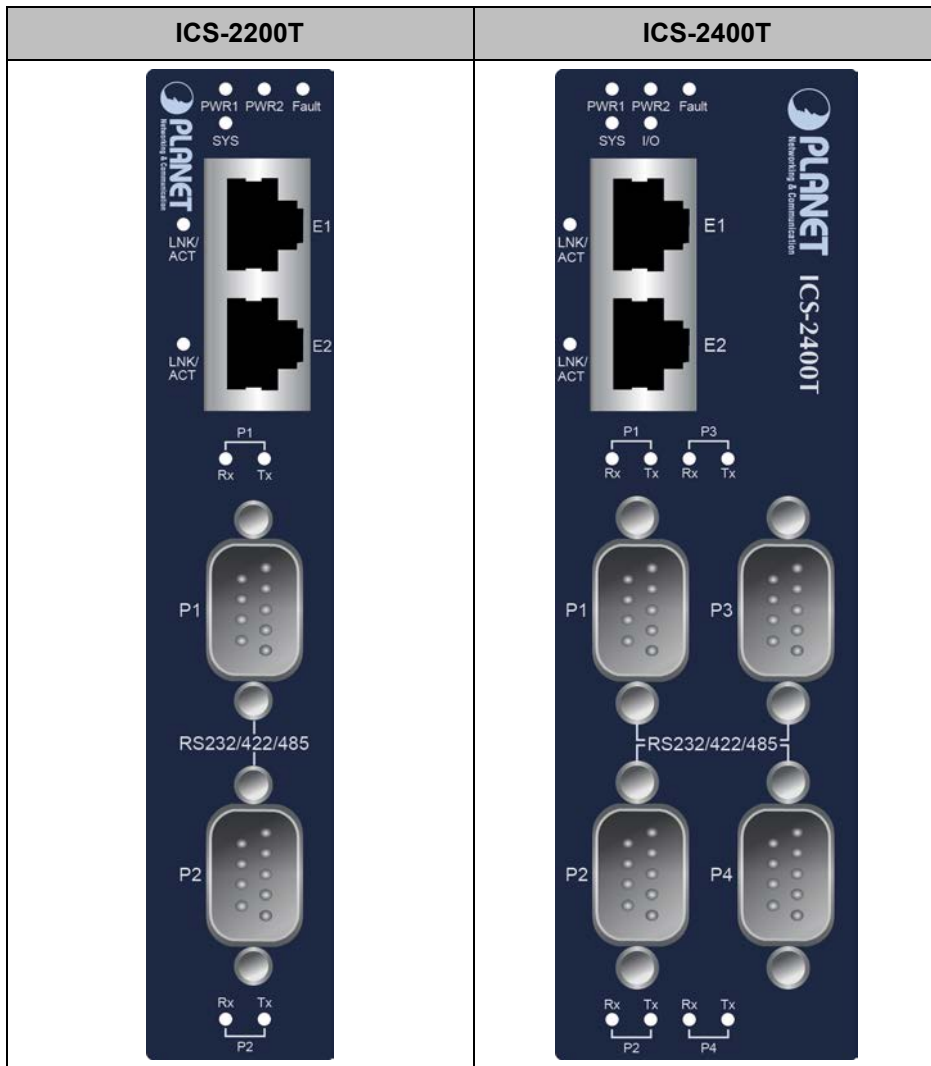

Figure 2-1-1: Front Panels of Industrial Serial Servers

■ **Fast TP/ SFP interface**

10/100BASE-TX copper, RJ45 twisted-pair: Up to 100 meters.

100BASE-FX SFP interface, Up to 2km~120km, vary on SFP modules.

■ **Serial Interface**

Supports RS-232, RS-422, RS-485 2-wire and RS485 4-wire.

2.1.2 Front Panel

The Reset Buttons of the Industrial Serial Servers are shown in Figure 2-1-2.

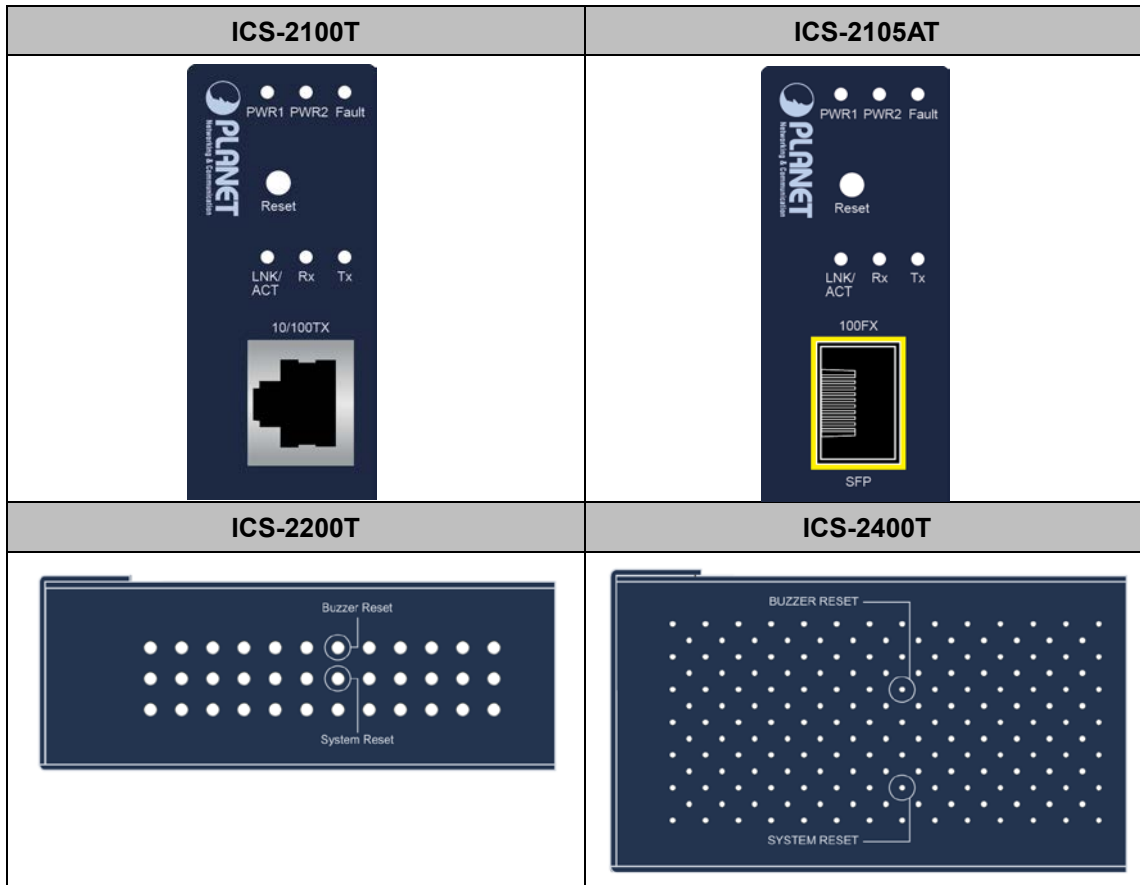

Figure 2-1-2: Reset Button of Industrial Serial Servers

■ Reset button

On the bottom panel, the reset button is designed for rebooting the system and stopping the buzzer. The following is the summary table of the reset button functions:

Reset Button	Reset Button Pressed and Released	Function
System Reset	< 5 sec: System reboot	Reboot the Industrial Serial Server
	> 5 sec: Factory default	Reset the Industrial Serial Server to Factory Default configuration. The Industrial Serial Server will then reboot and load the default settings as shown below: <ul style="list-style-type: none"> ◦ Default Username: admin ◦ Default Password: admin ◦ Default IP address: 192.168.0.100 ◦ Subnet mask: 255.255.255.0 ◦ Default Gateway: 192.168.0.254
Buzzer Reset	>1 sec	Stop the buzzer

2.1.3 LED Indications

The front panel LEDs indicate instant status of power and system status, fan status, port links and data activity; they help monitor and troubleshoot when needed.

LED indication

■ System

LED	Color	Function	
PWR 1	Green	Lights	Power 1 is activated.
PWR 2	Green	Lights	Power 2 is activated.
Fault	Red	Lights	Indicates either Power 1 or Power 2 has no power.
SYS	Green	Blinks	System is booting.
		Lights	System is ready.
I/O	Red	Blinks	Digital I/O event is triggered.

■ 10/100BASE-TX/100BASE-FX Port

LED	Color	Function	
LNK/ ACT	Green	Lights	Indicates that the port is linked up.
		Blinks	Indicates that the switch is actively sending or receiving data over that port.

■ Serial Ports (P1~P4)

LED	Color	Function	
TX	Green	Blinks	Serial port is transmitting data.
RX	Amber	Blinks	Serial port is receiving data.

2.1.4 Wiring the Power Inputs

The upper panel of the Industrial Serial Server indicates a DC inlet power socket and consists of one terminal block connector within 6 contacts. Please follow the steps below to insert the power wire.

1. Insert positive/negative DC power wires into **Contacts 1 and 2** for **Power 1**, or **Contacts 5 and 6** for **Power 2**. Figure 2-1-3 to 2-1-5 show PWR1 and PWR2 of the Industrial Serial Server.

- **ICS-2100T/ICS-2105AT/ICS-2102T/ICS-2102TS:** 9~48V DC or 24V AC

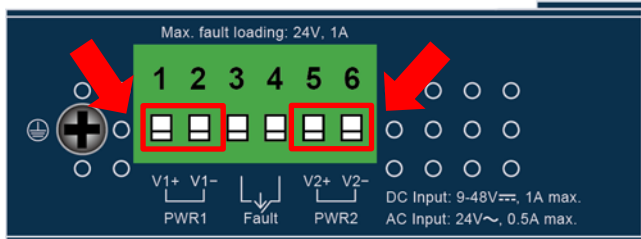

Figure 2-1-3 ICS-2100T/ICS-2105AT Upper Panel

- **ICS-2200T:** 12~48V DC

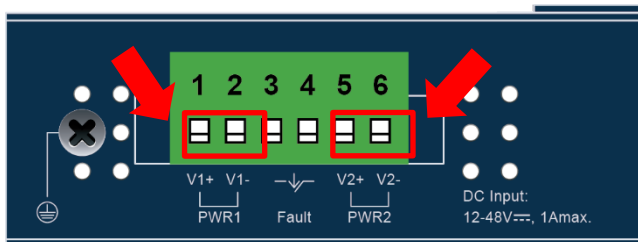

Figure 2-1-4 ICS-2200T Upper Panel

- **ICS-2400T:** 12~48V DC

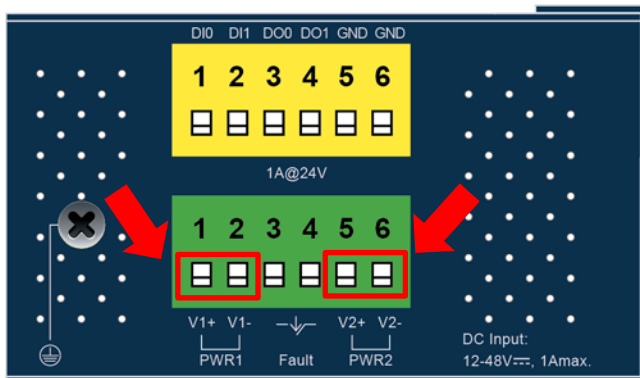
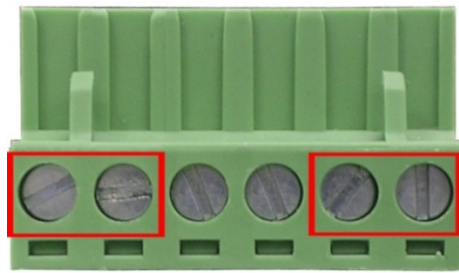

Figure 2-1-5 ICS-2400T Upper Panel

2. Tighten the wire-clamp screws for preventing the wires from loosening.



1	2	3	4	5	6
V1+	V1-			V2+	V2-
Power 1		Fault		Power 2	

Figure 3-3 PWR1 & PWR2 pina of terminal block.



The wire gauge for the terminal block should be in the range from 12 to 24 AWG.

2.1.5 Serial Port Pin Define

<i>Terminal Block</i>	<i>Pin</i>	<i>RS-422 RS-485-4W</i>	<i>RS-485-2W</i>
<input type="checkbox"/> 1 <input type="checkbox"/> 2 <input type="checkbox"/> 3 <input type="checkbox"/> 4	1	TxD+(A)	--
	2	TxD-(B)	--
	3	RxD-(B)	Data-(B)
	4	RxD+(A)	Data+(A)

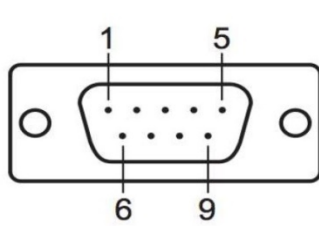
<i>Male DB9</i>	<i>Pin</i>	<i>RS232</i>	<i>RS422 RS485-4W</i>	<i>RS485-2W</i>
	1	DCD	TxD+	--
	2	RxD	TxD-	--
	3	TxD	RxD-	Data-
	4	DTR	RxD+	Data+
	5	GND	GND	GND
	6	DSR	--	--
	7	RTS	--	--
	8	CTS	--	--
	9	--	--	--

2.2 Installing the Industrial Serial Server

This section describes how to install your Industrial Serial Server and make connections to the Industrial Serial Server. Please read the following section and perform the procedure in the order being presented. To install your Industrial Serial Server on a desktop or rack, simply complete the following steps.

2.2.1 Installation Steps

1. **Unpack the Industrial Serial Server**
2. **Check if the DIN-rail bracket is screwed on the Industrial Serial Server or not.** If the DIN-rail bracket is not screwed on the **Industrial Serial Server**, please refer to **DIN-rail Mounting** section for DIN-rail installation. If users want to wall-mount the **Industrial Serial Server**, please refer to the **Wall Mount Plate Mounting** section for wall-mount plate installation.
3. **To hang the Industrial Serial Server on the DIN-rail track or wall.**
4. **Power on the Industrial Serial Server.** Please refer to the **Wiring the Power Inputs** section for knowing the information about how to wire the power. The power LED on the **Industrial Serial Server** will light up. Please refer to the **LED Indicators** section for indication of LED lights.
5. **Prepare Network cables for Ethernet connection.**
 - Use standard network (UTP) cables with RJ45
 - Use Multi-mode or Single-mode fiber patch cord with LC connector and 100BASE-FX SFP transceiver (ICS-2105AT only).
6. **Insert one side of RJ45 cable (category 5) or Fiber cable into the Industrial Serial Server Ethernet port** (RJ45/SFP port) while the other side to the network device's Ethernet port (RJ45/SFP port), e.g., Switch PC or Server. The "**LNK/ACT**" LED on the **Industrial Serial Server** will light up when the cable is connected with the network device. Please refer to the **LED Indicators** section for LED light indication.



Make sure that the connected network devices support MDI/MDI-X. If it does not support, use the crossover Category 5 cable.

7. **When all connections are set and all LED lights show normal, the installation is completed.**

2.2.2 DIN-rail Mounting

This section describes how to install the **Industrial Serial Server**. There are two methods to install the **Industrial Serial Server** -- DIN-rail mounting and wall-mount plate mounting. Please read the following section and perform the procedure in the order being presented.



Follow all the DIN-rail installation steps as shown in the example.

Step 1: Screw the DIN-rail bracket on the **Industrial Serial Server**.



Step 2: Lightly slide the DIN-rail bracket into the track.



Step 3: Check whether the DIN-rail bracket is tightly on the track.

Please refer to the following procedure to remove the **Industrial Serial Server** from the track.

Step 4: Lightly remove the unit from the track.



2.2.3 Wall Mount Plate Mounting

To install the **Industrial Serial Server** on the wall, please follow the instructions below.



Follow all the DIN-rail installation steps as shown in the example.

Step 1: Remove the DIN-rail bracket from the **Industrial Serial Server**. Use the screwdriver to loosen the screws to remove the DIN-rail bracket.

Step 2: Place the wall-mount plate on the rear panel of the **Industrial Serial Server**.



Step 3: Use the screwdriver to screw the wall-mount plate on the **Industrial Serial Server**.

Step 4: Use the hook holes at the corners of the wall mount plate to hang the **Industrial Serial Server** on the wall.

Step 5: To remove the wall-mount plate, reverse the steps above.

3. INDUSTRIAL SERIAL SERVER MANAGEMENT

This chapter covers the following topics as to how to manage the Industrial Serial Server:

- Requirements
- Web Management
- Remote Management
- PLANET Smart Discovery Utility

3.1 Requirements

- **Workstations** running Windows 2000/XP, 2003, Vista/7/8/10, 2008, MAC OS9 or later, or Linux, UNIX , or other platforms compatible with **TCP/IP** protocols.
- **Workstation** is installed with **Ethernet NIC** (Network Interface Card)
- **Network cables**
 - Use standard network (UTP) cables with RJ45
 - Use Multi-mode or Single-mode fiber patch cord with LC connector and 100BASE-FX SFP transceiver (ICS-2105AT only).
- The above workstation is installed with **Web Browser** and **JAVA runtime environment** plug-in



It is recommended to use Internet Explorer 7.0 or above to access Industrial Serial Server.

3.2 Web Management

The Industrial Serial Server offers management features that allow users to manage the Industrial Serial Server from anywhere on the network through a standard browser such as Microsoft Internet Explorer. After you set up your IP address for the switch, you can access the Industrial Serial Server's Web interface applications directly in your Web browser by entering the IP address of the Industrial Serial Server.

For example, the default IP address of the Industrial Serial Server is **192.168.0.100**, then the manager PC should be set to **192.168.0.x** (where x is a number between 1 and 254, except 100), and the default subnet mask is 255.255.255.0.

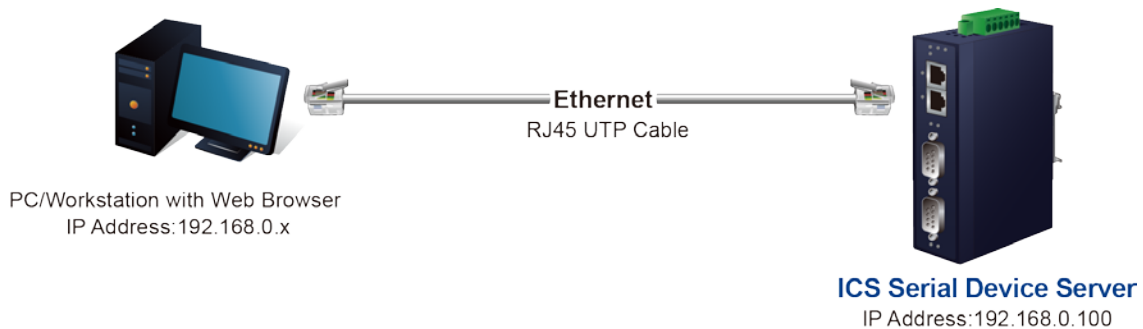

Figure 3-2-1: Web Management

You can then use your Web browser to list and manage the Industrial Serial Server configuration parameters from one central location, just as if you were directly connected to the Industrial Serial Server's console port. Web Management requires either **Microsoft Internet Explorer 7.0** or later, **Safari** or **Mozilla Firefox 1.5** or later.

3.2.1 Logging in to the Industrial Serial Server

1. Use Internet Explorer 8.0 or above for Web browser and enter IP address **<http://192.168.0.100>** (the factory default IP address) to access the Web interface.
2. When the following dialog box appears, please enter the default user name "**admin**" and password "**admin**" (or the password you have changed before) as shown in Figure 4-2.

Default IP Address: **192.168.0.100**
Default User Name: **admin**
Default Password: **admin**

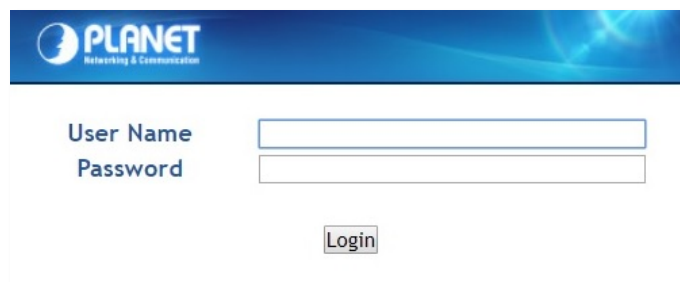

Figure 3-2-2: Login Screen

3. After entering the password, the main screen appears as shown in Figure 3-2-3.

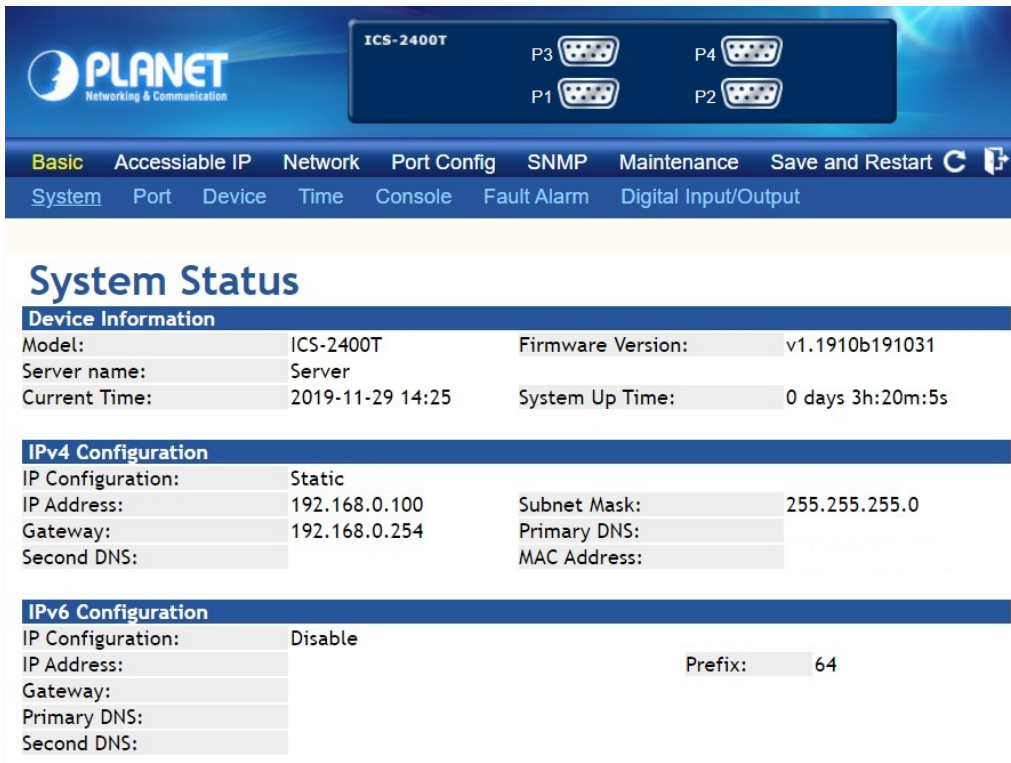

Figure 3-2-3: Web Main Screen of Industrial Serial Server

4. The Main Menu in the middle of the Web page lets you access all the functions and statuses. It appears as shown in Figure 3-2-4.

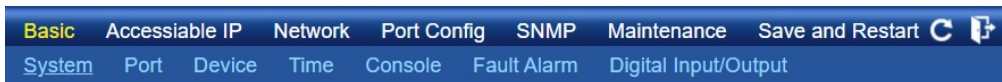

Figure 3-2-4: Main menu

Now, you can use the Web management interface to continue the Serial Server management. Please refer to the user manual for more.



1. For security reason, **please change and memorize the new password after this first setup.**
2. Only accept command in lowercase letter under web interface.

3.3 Remote Management

The Industrial Serial Server also supports Telnet for remote management. You can use Telnet to open a terminal session over one of the Ethernet ports. The Serial Server asks for user name and password for remote login when using Telnet; please use the following default IP address, username and password for the first-time login.

Default IP Address: **192.168.0.100**

Default Username: **admin**

Default Password: **admin**

You will be presented with a text menu displaying the Industrial Serial Server's general settings, which you will be able to view and modify. It appears as shown in Figure 3-3-1.

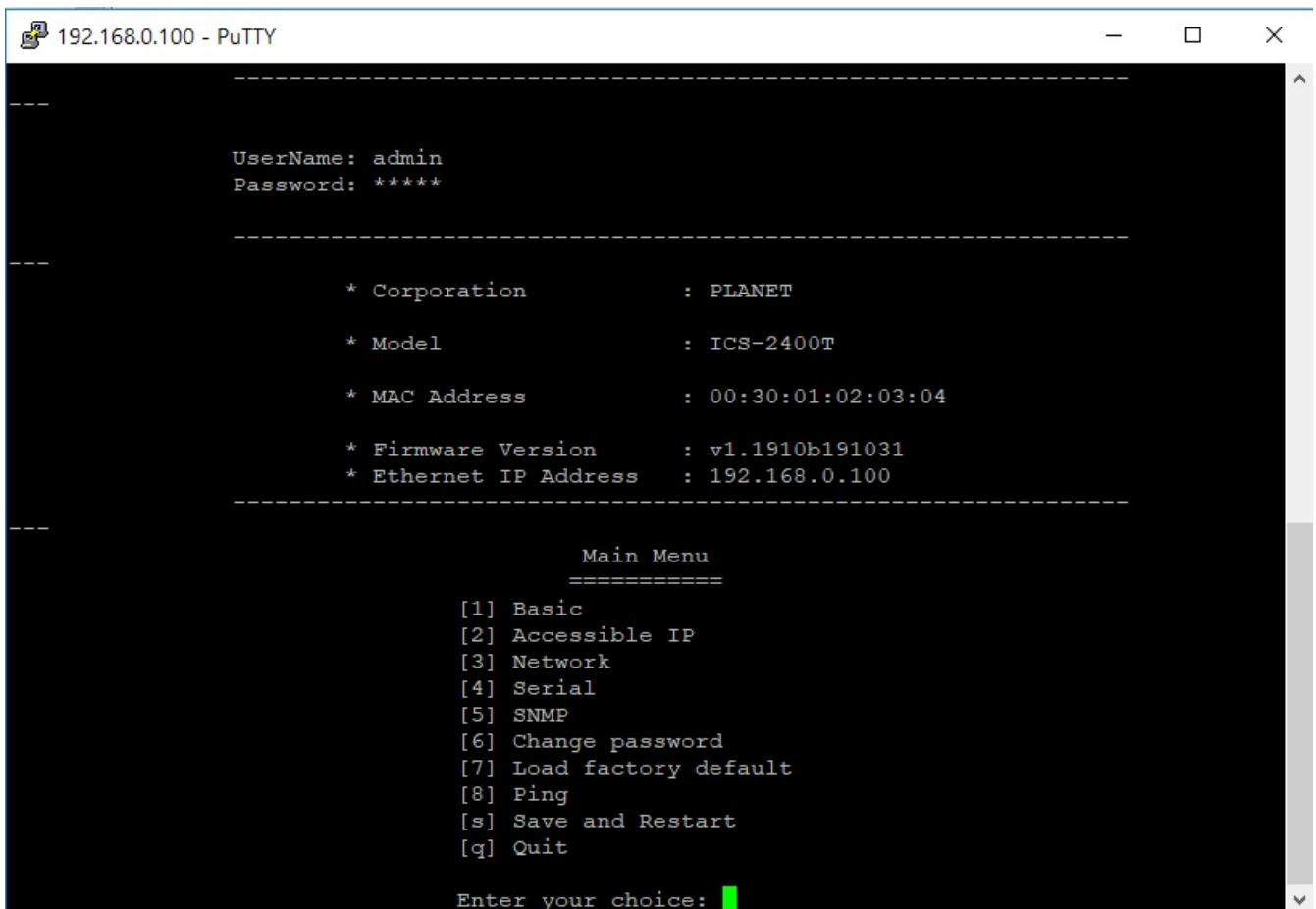

```
192.168.0.100 - PuTTY
-----
UserName: admin
Password: *****
-----
* Corporation      : PLANET
* Model           : ICS-2400T
* MAC Address     : 00:30:01:02:03:04
* Firmware Version : v1.1910b191031
* Ethernet IP Address : 192.168.0.100
-----
Main Menu
=====
[1] Basic
[2] Accessible IP
[3] Network
[4] Serial
[5] SNMP
[6] Change password
[7] Load factory default
[8] Ping
[s] Save and Restart
[q] Quit
Enter your choice: █
```

Figure 3-3-1: Remote Management

3.4 PLANET Smart Discovery Utility

For easily listing the Industrial Serial Server in your Ethernet environment, the Planet Smart Discovery Utility is an ideal solution. The following installation instructions are to guide you to running the Planet Smart Discovery Utility.

1. Download the Planet Smart Discovery Utility from the administrator PC.
2. Run this utility as the following screen appears.

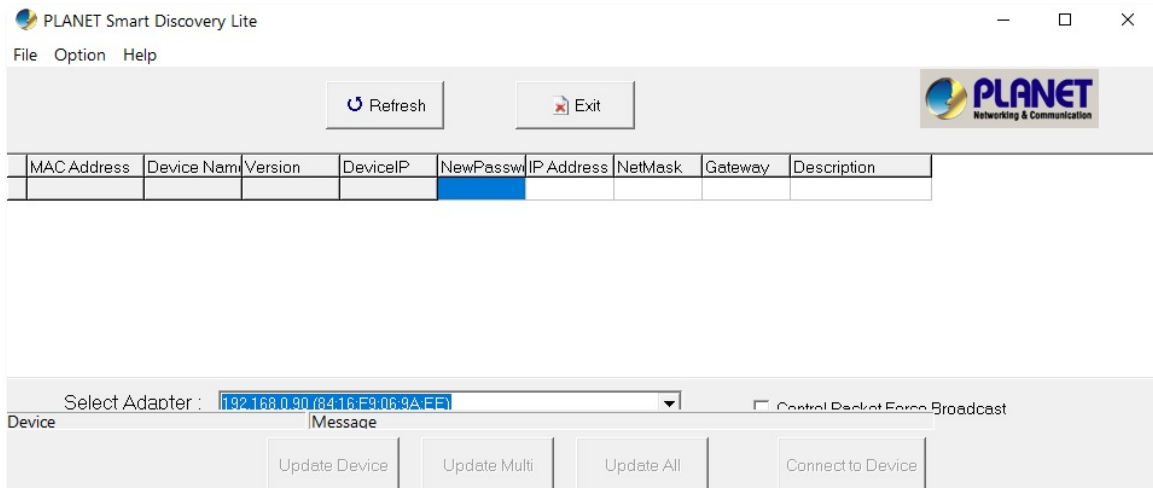

Figure 3-4-1: Planet Smart Discovery Utility Screen



If there are two LAN cards or above in the same administrator PC, choose a different LAN card by using the **“Select Adapter”** tool.

3. Press the **“Refresh”** button for the currently connected devices in the discovery list as shown in [Figure 3-4-2.](#):

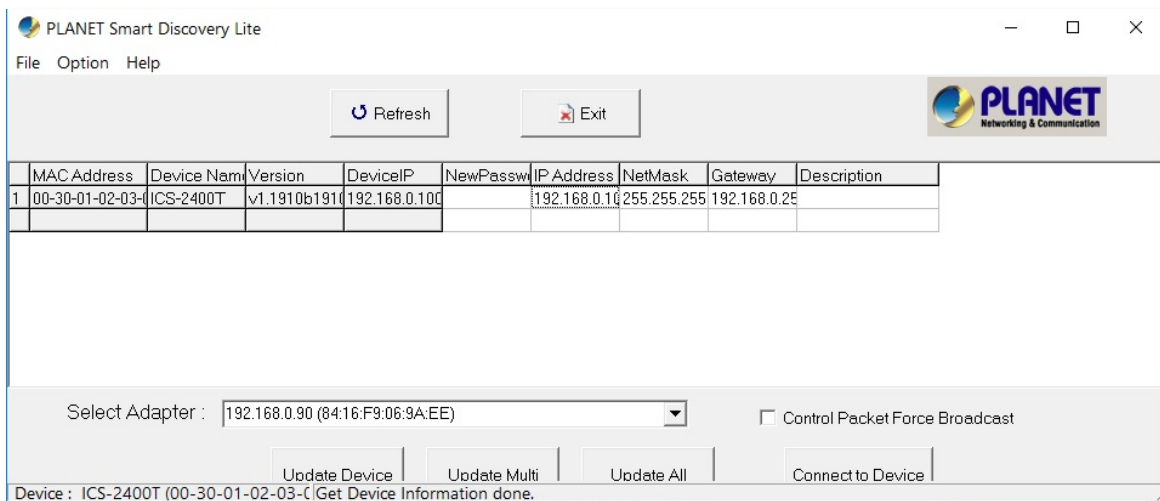

Figure 3-4-2: Planet Smart Discovery Utility Screen

1. This utility shows all the necessary information from the devices, such as MAC address, device name, firmware version, and device IP subnet address. It can also assign new password, IP subnet address and description to the devices.

2. After setup is completed, press the **“Update Device”**, **“Update Multi”** or **“Update All”** button to take effect. The functions of the 3 buttons above are shown below:

- **Update Device:** Use current setting on one single device.
- **Update Multi:** Use current setting on multi-devices.
- **Update All:** Use current setting on whole devices in the list.

The same functions mentioned above also can be found in **“Option”** tools bar.

3. To click the **“Control Packet Force Broadcast”** function, it allows you to assign a new setting value to the Web Smart Switch under a different IP subnet address.

4. Press the **“Connect to Device”** button and the Web login screen appears as shown in [Figure 3-4-2](#).

5. Press the **“Exit”** button to shut down the Planet Smart Discovery Utility.

4. WEB CONFIGURATION

This section introduces the configuration and functions of the Web-based management from Industrial Serial Server.

About Web-based Management

The Industrial Serial Server offers management features that allow users to manage the Industrial Serial Server from anywhere on the network through a standard browser such as Microsoft Internet Explorer.

The Web-based Management supports Internet Explorer 7.0. It is based on Java Applets with an aim to reduce network bandwidth consumption, enhance access speed and present an easy viewing screen.



By default, IE7.0 or later version does not allow Java Applets to open sockets. The user has to explicitly modify the browser setting to enable Java Applets to use network ports.

The Industrial Serial Server can be configured through an Ethernet connection, making sure the manager PC must be set to the same IP subnet address with the Industrial Serial Server.

For example, the default IP address of the Industrial Serial Server is **192.168.0.100**, then the manager PC should be set to **192.168.0.x** (where x is a number between 1 and 254, except 100), and the default subnet mask is 255.255.255.0.

If you have changed the default IP address of the Industrial Serial Server to 192.168.1.1 with subnet mask 255.255.255.0 via console, then the manager PC should be set to 192.168.1.x (where x is a number between 2 and 254) to do the relative configuration on manager PC.

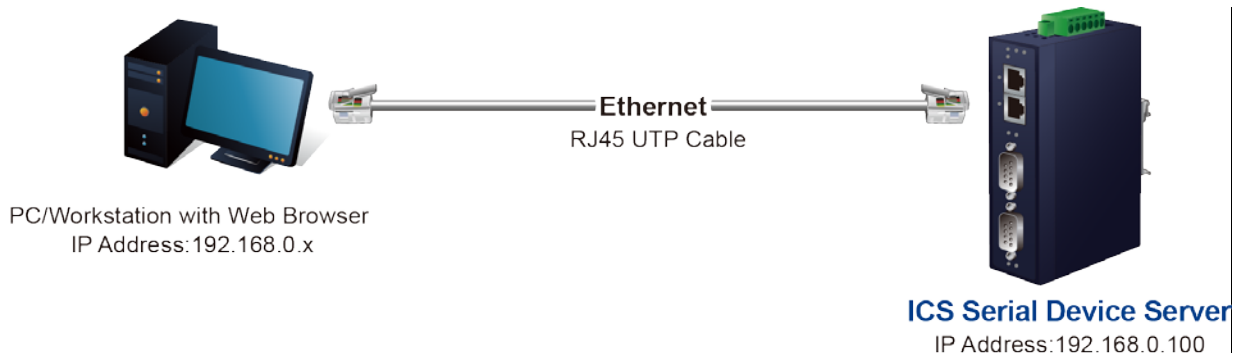

Figure 4-1-1: Web Management

■ **Logging on to the Industrial Serial Server**

1. Use Internet Explorer 7.0 or above Web browser. Enter the factory default IP address to access the Web interface. The factory default IP address is shown as follows:

Default IP Address: **192.168.0.100**
 Default Username: **admin**
 Default Password: **admin**

2. When the following login screen appears, please enter the default username "**admin**" with password "**admin**" (or the username/password you have changed via console) to log in the main screen of **Industrial Industrial Serial Server**. The login screen in [Figure 4-1-2](#) appears.

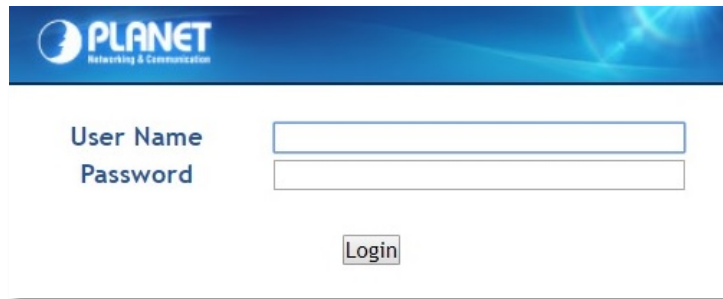

Figure 4-1-2: Login Screen

3. After a successful login, the main screen appears as shown in [Figure 4-1-3](#) below.

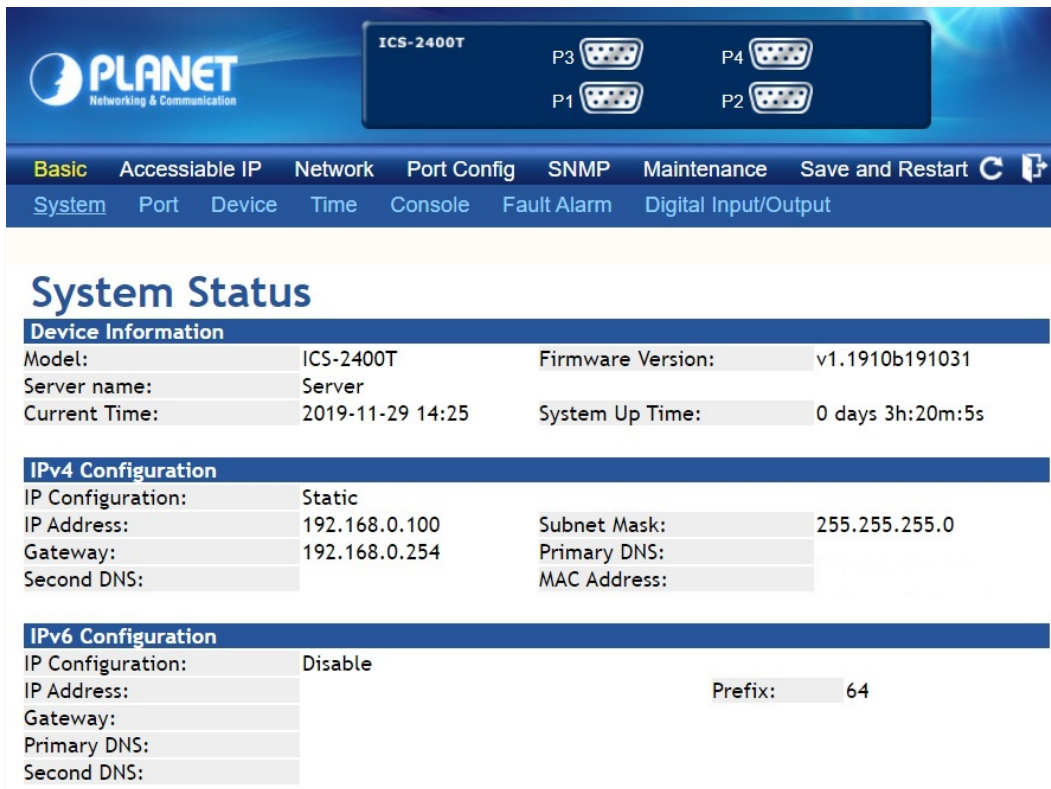

Figure 4-1-3: Web Main Page

Now, you can use the Web management interface to continue the switch management or manage the Industrial Serial Server by Web interface.

4.1 Main Web Page

The Industrial Serial Server provides a Web-based browser interface for configuring and managing it. This interface allows you to access the Industrial Serial Server using the Web browser of your choice. The main web page is shown in [Figure 4-1-4](#)

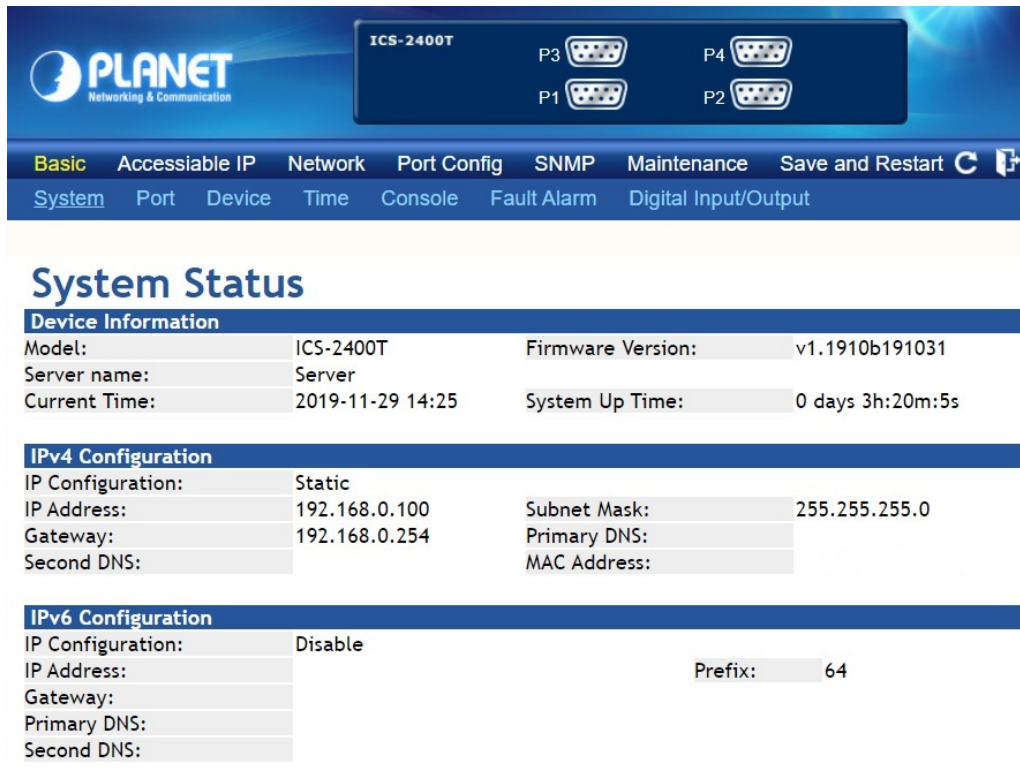



Figure 4-1-4: Web Main Page

Main Menu

Via the Web Management, the administrator can set up the Industrial Serial Server by selecting the functions that are listed in the Main Function. The screen in [Figure 4-1-5](#) appears.



Figure 4-1-5: Industrial Serial Server Main Functions Menu

Object	Description
• Basic	The essential device information of Industrial Serial Server.
• Accessible IP	To configure IP address lists to prevent unauthorized access.
• Network	To configure IP address information of Industrial Serial Server.
• Port Config	To configure serial port value and port mode of Industrial Serial Server.
• SNMP	To configure SNMP information of Industrial Serial Server.
• Maintenance	The management of Industrial Serial Server.
• Save and Restart	Save the configuration and reboot device.
• 	Refresh the page
• 	Log out the Industrial Serial Server.

4.2 System

Use the System menu items to display and configure basic administrative details of the Industrial Serial Server. Under the System, the following topics are provided to configure and view the system information. This section has the following items:

- **System** The Industrial Serial Server system information is provided here.
- **Port** This page displays status of each port.
- **Device** Configure device name and syslog server on this page.
- **Time** Configure NTP server or manually adjust time on this page.
- **Console** Configure management methods on this page.
- **Fault Alarm** Configure fault alarm on this page.
- **Digital Input/Output** Configure digital input and output on this page.

4.2.1 System

The System page provides basic information for the current device. System page helps an administrator to identify software version, system uptime and IP address information. The screen in [Figure 4-2-1](#) appears.

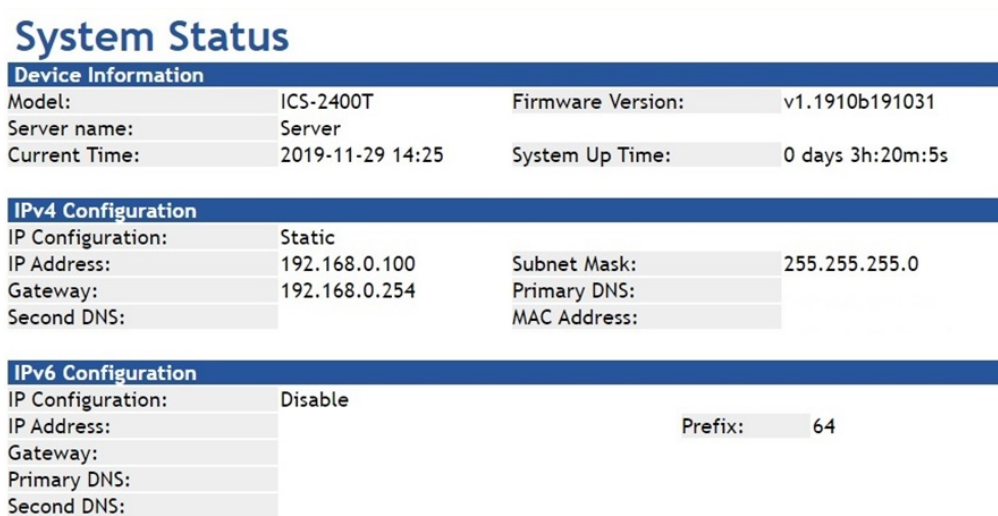

System Status

Device Information			
Model:	ICS-2400T	Firmware Version:	v1.1910b191031
Server name:	Server		
Current Time:	2019-11-29 14:25	System Up Time:	0 days 3h:20m:5s

IPv4 Configuration			
IP Configuration:	Static		
IP Address:	192.168.0.100	Subnet Mask:	255.255.255.0
Gateway:	192.168.0.254	Primary DNS:	
Second DNS:		MAC Address:	

IPv6 Configuration			
IP Configuration:	Disable		
IP Address:		Prefix:	64
Gateway:			
Primary DNS:			
Second DNS:			

Figure 4-2-1: System Status Page Screenshot

The page includes the following fields:

Device Information

Object	Description
• Model	Specifies the device model name.
• Firmware Version	The firmware version of industrial serial server.
• Name	The system name configured in Basic/Device Name.
• Current Time	The current (GMT) system time and date.
• System Up Time	The period of time the device has been operational.

IPv4 Configuration

Object	Description
• IP Configuration	The status of IPv4 configuration.
• IP Address	The current IPv4 address of the device.
• Subnet Mask	The current IPv4 subnet mask of the device.
• Gateway	The current IPv4 gateway of the device.
• Primary DNS	The current first DNS server of the device.
• Second DNS	The current second DNS server of the device.
• MAC Address	Specifies the device MAC address.

IPv6 Configuration

Object	Description
• IP Configuration	The status of IPv6 configuration.
• IP Address	The current IPv6 address of the device.
• Prefix	The IPv6 network mask, in number of bits (prefix length).
• Gateway	The current gateway for the IPv6 interface.
• Primary DNS	The current first DNS server of the device.
• Second DNS	The current second DNS server of the device.

4.2.2 Port

This Port page displays the status of each port, including operation mode and serial settings. The screen in [Figure 4-2-2](#) appears.

Port Status

No.	Operation Mode	Baud Rate	Stop Bits	Data Bits	Parity	Interface	Flow Control
1	TCP Server	921600	1	8	None	RS-232	None
2	TCP Server	921600	1	8	None	RS-232	None
3	TCP Server	921600	1	8	None	RS-232	None
4	TCP Server	921600	1	8	None	RS-232	None

Figure 4-2-2: Port Status Page Screenshot

The following column shows the Port statuses:

Object	Description
• No.	The serial number (No.) indicates port number. It can be directly linked to the corresponding page settings.
• Operation Mode	The current operation mode of industrial serial server.
• Baud Rate	The rate of data transmission to and from the attached serial device.
• Stop Bits	The stop bit follows the data and parity bits in serial communication. It indicates the end of transmission. The default is 1 .
• Data Bits	Indicates the number of the bits in a transmitted data package. The default is 8 .
• Parity	Checks for the parity type. The default value is none .
• Interface	The industrial device server supports three interfaces. The default value is RS-232 . <ul style="list-style-type: none"> ■ RS-232 ■ RS-422 ■ RS-485 2-Wire ■ RS-485 4-Wire
• Flow Control	The method is used to suspend and resume data transmission to ensure that data is not lost. The default value is none .

4.2.3 Device

This page provides configuration of device name and syslog server. The screen in [Figure 4-2-3](#) appears.

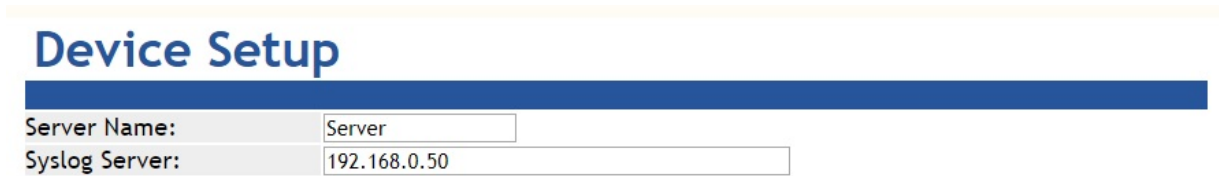

Figure 4-2-3: Device Setup Page Screenshot

The page includes the following fields:

Object	Description
• Server Name	To configure the name of server. The default value is Server .
• Syslog Server	To configure IP address of syslog server.



When applying any configuration changes of industrial serial server, it's required to **save changed configuration and reboot system**. Therefore the new configuration will be applied after rebooting.

4.2.4 Time

This page provides configuration of NTP server and Time modification. The screen in [Figure 4-2-4](#) appears.

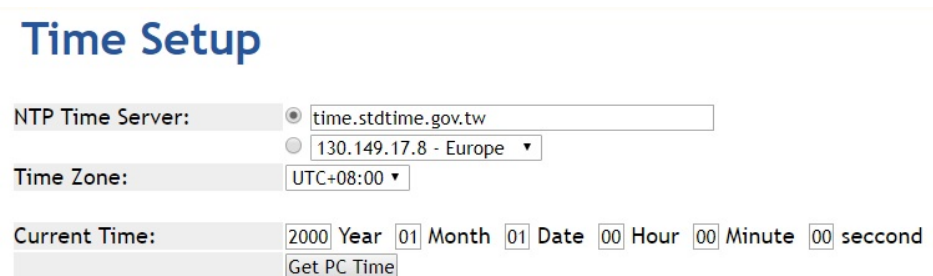

Figure 4-2-4: Time Setup Page Screenshot

The page includes the following fields:

Object	Description
• NTP Time Server	To configure NTP server for time synchronization. The default is time.stdtime.gov.tw .
• Time Zone	Lists various Time Zones worldwide. Select appropriate Time Zone from the drop-down menu and click Save to set.
• Current Time	To manually set the Year / Mouth / Day/ Hour / Minute / Second or get time from PC in this page.

4.2.5 Console

This page is to configure management methods for web and remote console. The screen in [Figure 4-2-5](#) appears.



Figure 4-2-5: Console Setup Page Screenshot

The page includes the following fields:

Object	Description
• Web Console	To enable or disable access to the web console. The default is Enable .
• Remote Console	To enable or disable access to the remote console. The default is Enable .
• Current Time	To check whether the reset button is working or not. The default is No .

4.2.6 Fault Alarm

This page provides configuration for fault alarm. The screen in [Figure 4-2-6](#) appears.

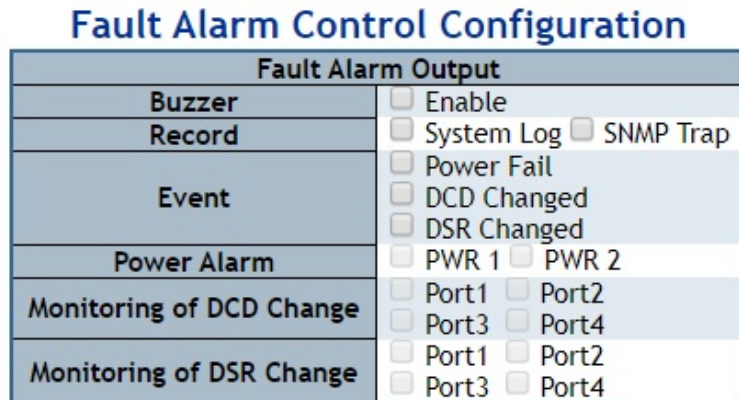

Figure 4-2-6: Fault Alarm Control Page Screenshot

The page includes the following fields:

Object	Description
• Buzzer	To check whether Buzzer is enabled on this switch.
• Record	To check whether Record is sending System log or SNMP Trap or both.
• Event	To check whether Power, Connection, etc. are working or not.
• Power Alarm	PWR1 or PWR2 or both have faulted..
• Monitoring of DCD Change	Monitor which Port or all for DCD signal that has changed.
• Monitoring of DSR Change	Monitor which Port or all for DSR signal that has changed.

4.2.7 Digital Input and Output

Digital Input allows user to log external device (such as industrial cooler). System will log a user customized message into system log and issue SNMP trap.

Digital Output allows user to monitor whether the power or DCD/DSR signal has changed, and let system issue a high or low signal to an external device (such as alarm) when power fails. The Configuration screen in [Figure 4-2-7](#) appears.

Digital Input/Output Control Configuration

Digital Input 0		Digital Input 1	
Enable	<input type="checkbox"/> Enable	Enable	<input type="checkbox"/> Enable
DI Condition	High to Low ▾	DI Condition	High to Low ▾
Event Description	<input type="text"/>	Event Description	<input type="text"/>
Action	<input type="checkbox"/> Syslog <input type="checkbox"/> SNMP Trap	Action	<input type="checkbox"/> Syslog <input type="checkbox"/> SNMP Trap

Digital Output 0		Digital Output 1	
Enable	<input type="checkbox"/> Enable	Enable	<input type="checkbox"/> Enable
Event	<input type="checkbox"/> Power Fail	Event	<input type="checkbox"/> Power Fail
	<input type="checkbox"/> DCD Changed		<input type="checkbox"/> DCD Changed
	<input type="checkbox"/> DSR Changed		<input type="checkbox"/> DSR Changed
	<input type="checkbox"/> DI 0 <input type="checkbox"/> DI 1		<input type="checkbox"/> DI 0 <input type="checkbox"/> DI 1
	<input type="checkbox"/> PWR 1 <input type="checkbox"/> PWR 2		<input type="checkbox"/> PWR 1 <input type="checkbox"/> PWR 2
Power Alarm	<input type="checkbox"/> Port1 <input type="checkbox"/> Port2	Power Alarm	<input type="checkbox"/> Port1 <input type="checkbox"/> Port2
Monitoring of DCD Change	<input type="checkbox"/> Port3 <input type="checkbox"/> Port4	Monitoring of DCD Change	<input type="checkbox"/> Port3 <input type="checkbox"/> Port4
Monitoring of DSR Change	<input type="checkbox"/> Port1 <input type="checkbox"/> Port2	Monitoring of DSR Change	<input type="checkbox"/> Port1 <input type="checkbox"/> Port2
	<input type="checkbox"/> Port3 <input type="checkbox"/> Port4		<input type="checkbox"/> Port3 <input type="checkbox"/> Port4

Figure 4-2-7: Time Configuration Page Screenshot

The page includes the following fields:

Object	Description
<ul style="list-style-type: none"> • Enable 	Check the Enable checkbox to enable Digital Input / output function. Uncheck the Enable checkbox to disable Digital input / output function.
<ul style="list-style-type: none"> • DI Condition 	Allows user to select High to Low or Low to High. This means a signal received by system is from High to Low or from Low to High. It will trigger an action that logs a customized message or issue the message from the switch.
<ul style="list-style-type: none"> • Event Description 	Allows user to set a customized message for Digital Input function alarm.
<ul style="list-style-type: none"> • Action 	Allows user to record alarm message to System log, or issues out via SNMP trap. As default SNMP trap is disabled, please enable them first if you want to issue alarm message via them.
<ul style="list-style-type: none"> • Event 	Alarm will sound when power and connection fails; Digital Input 0 (DI 0) and Digital Input 1(DI 1) means Digital Output has detected these events. Then Digital Output would be triggered according to the settings of the condition.
<ul style="list-style-type: none"> • Power Alarm 	Allows user to choose which power module that needs to be monitored.
<ul style="list-style-type: none"> • Monitoring of DCD Change 	Allows user to choose which port that needs to be monitored when DCD signal changes
<ul style="list-style-type: none"> • Monitoring of DSR Change 	Allows user to choose which port that needs to be monitored when DSR signal changes.

4.3 Accessible IP

This page provides the specified IP address to connect with industrial serial server. When the list of accessible IP is enabled, only IP address in the list can connect to device. When the function is disabled, there is no such restriction. List allows user to configure up to four IP groups. The accessible IP setup screen in [Figure 4-3-1](#) appears.

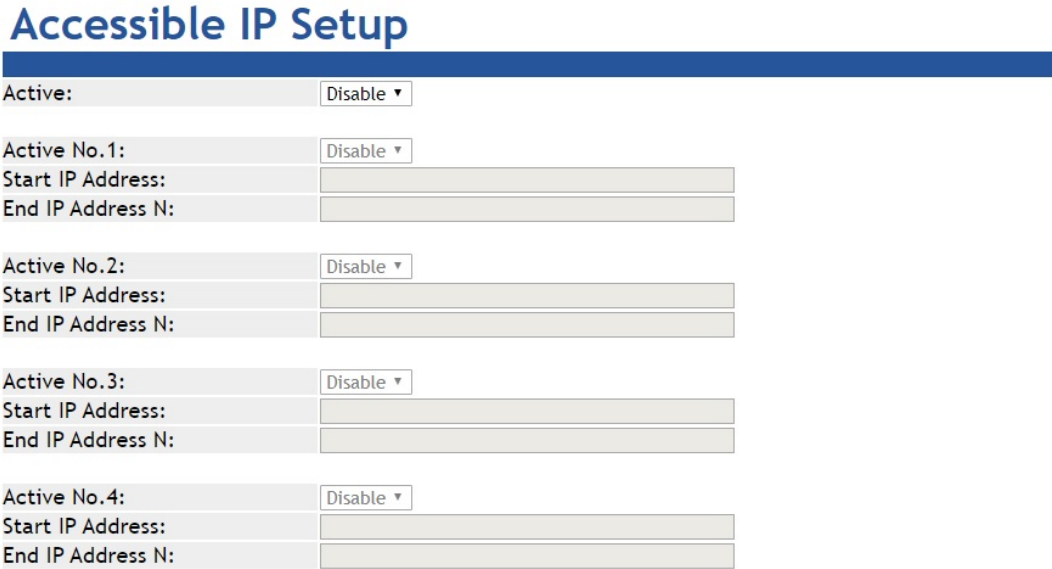

Figure 4-3-1: Accessible IP Setup Page Screenshot

The page includes the following fields:

Object	Description
<ul style="list-style-type: none"> Active 	Configure the accessible IP list. Possible modes are: Disabled: Disable accessible IP lists. Enabled: Enable accessible IP lists.
<ul style="list-style-type: none"> Activate NO 	Enable or disable activated IP groups.
<ul style="list-style-type: none"> Start IP Address 	Enter the IP address for starting.
<ul style="list-style-type: none"> End IP Address N 	Enter the IP address for ending

Example

Allowed hosts	Start: IP Address setting	End: IP Address N
<ul style="list-style-type: none"> Any host 	disable	disable
<ul style="list-style-type: none"> 192.168.0.120 	192.168.0.120	
<ul style="list-style-type: none"> 192.168.0.1 to 192.168.0.254 	192.168.0.1	192.168.0.254

4.4 Network

This page allows the user to configure IPv4 or IPv6 address. The IP configuration screen in [Figure 4-4-1](#) appears.

IP Configuration

IPv4 Configuration

IP Configuration:	Static ▾
IP Address:	192.168.0.100
Subnet Mask:	255.255.255.0
Gateway:	192.168.0.254
Primary DNS:	
Second DNS:	

IPv6 Configuration

IP Configuration:	Disable ▾
IP Address:	[Example] Global 2000::/3,ULA fd00::/7
Prefix:	64
Gateway:	
Primary DNS:	
Second DNS:	

Figure 4-4-1: IP Configuration Page Screenshot

The page includes the following fields:

IPv4

Object	Description
<ul style="list-style-type: none"> • IP Configuration 	Configure static or DHCP to get IPv4 address. The default value is static . <ul style="list-style-type: none"> ■ static: Set a fixed IPv4 address that was manually configured for a device ■ DHCP: Set IPv4 address automatically assigned from a DHCP server.
<ul style="list-style-type: none"> • IP Address 	The current IPv4 Address of the device. The IP Address could be manually assigned. The default value is 192.168.0.100 .
<ul style="list-style-type: none"> • Subnet Mask 	The current IP subnet mask of the device. The default value is 255.255.255.0 .
<ul style="list-style-type: none"> • Gateway 	The default gateway for the IP interface. The default value is 192.168.0.254 .
<ul style="list-style-type: none"> • Primary DNS 	Configure the first DNS server.
<ul style="list-style-type: none"> • Second DNS 	Configure the second DNS server.

IPv6

Object	Description
<ul style="list-style-type: none"> • IP Configuration 	Configure static , SLAAC/DHCP and disable for IPv6 address. The default value is disable . <ul style="list-style-type: none"> ■ Static: Set a fixed IPv6 address that was manually configured for a device ■ SLAAC/DHCP: Set IPv6 address automatically assigned from a DHCPv6 server. ■ Disable: Disable IPv6 protocol.
<ul style="list-style-type: none"> • IP Address 	The current IPv6 Address of the device.

• Prefix	The IPv6 network mask, in number of bits (prefix length). The default value is 64 .
• Gateway	The default gateway for the IPv6 interface.
• Primary DNS	Configure the first DNS server.
• Second DNS	Configure the second DNS server.

4.5 Port Config

The following figure shows port settings. Note that these settings need to match the parameters on serial port of the serial device. Each parameter is described in details in the following section. The port configuration screen in [Figure 4-5-1](#) appears.

Port 1 Setup

Description:	<input type="text"/>	Baud Rate:	921600 ▾
Data Bits:	8 ▾	Any Baud Rate:	50 (50 - 921600)
Stop Bits:	1 ▾	Parity:	None ▾
Interface:	RS-232 ▾	FlowControl:	None ▾

Operation Mode:	TCP Server Mode ▾		
TCP Keep-alive Interval:	0	(min)	
Quiescent Time:	0	(0 - 65535 ms)	
Max Connection:	1 ▾		
Local TCP Port:	5004		
Frame Length:	0	(0 - 1300)	
Separator:	00	(HEX)	Enable: <input type="checkbox"/>
Separator Process:	Do Nothing ▾		
Separator Time Out:	0	(0 - 65535 ms)	

Apply to all serial ports:

Figure 4-5-1: Port Setup Page Screenshot

4.5.1 Serial setup

The serial setup screen is shown in [Figure 4-5-2](#).

Description:	<input type="text"/>	Baud Rate:	921600 ▾
Data Bits:	8 ▾	Any Baud Rate:	50 (50 - 921600)
Stop Bits:	1 ▾	Parity:	None ▾
Interface:	RS-232 ▾	FlowControl:	None ▾

Figure 4-5-2: Serial Setup Page Screenshot

Object	Description
• Description	Used to distinguish the name of each serial port. It allows 1 to 15 characters (e.g. A-Z, a-z, 0-9)
• Baud Rate	The rate of data transmission to and from the attached serial device. It allows 50 bps to 921600 bps. The default is 921600 bps .
• Stop Bits	The stop bit follows the data and parity bits in serial communication. It indicates the end of transmission. The default is 1 .
• Data Bits	Indicates the number of the bits in a transmitted data package. The allowed value is 5,6,7,8 and default value is 8 .
• Parity	This parameter controls the error checking mode. It support five modes and default value is none . <ul style="list-style-type: none"> ■ Even ■ Odd ■ None ■ Space ■ Mark
• Interface	The industrial device server supports three interfaces. The default value is RS-232 . <ul style="list-style-type: none"> ■ RS-232 ■ RS-422 ■ RS-485 2-Wire ■ RS-485 4-Wire
• Flow Control	The method is used to suspend and resume data transmission to ensure that data is not lost. It supports four methods and default value is none . <ul style="list-style-type: none"> ■ None ■ RTS/CTS ■ Xon/Xoff ■ DTR/DSR

4.5.2 Operation mode

The industrial serial server makes connected Serial equipment become IP-based. That also makes them able to connect to a TCP/IP networking immediately. The industrial serial server allows traditional Computer/Client COM ports access to a serial equipment anywhere on the Ethernet LAN network.

This operation mode can be set up as **Disable**, **Remote Pair Master/Slave**, **RF2217**, **Serial Telnet**, **TCP Server**, **TCP Client**, **UDP**, **Virtual COM** and **Modbus Converter Server/Client**. The operation mode screen in [Figure 4-5-3](#) appears.

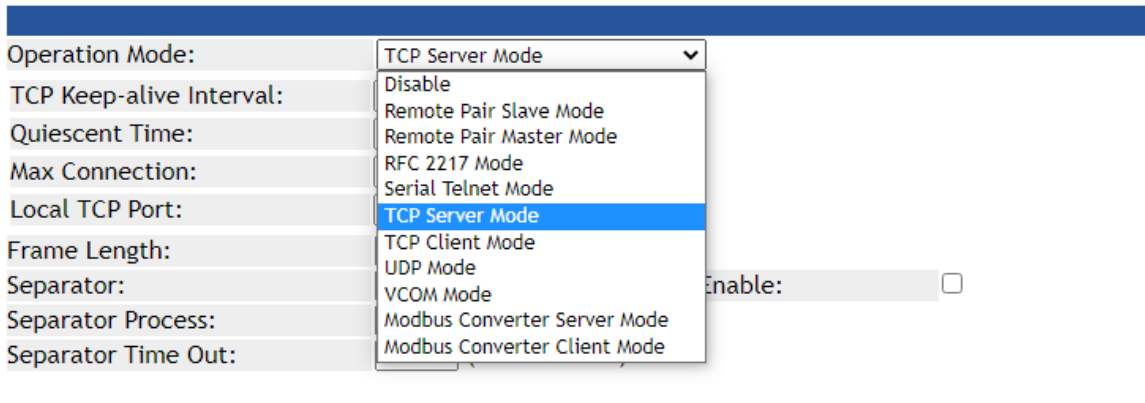

Figure 4-5-3: Operation Mode Screenshot

4.5.2.1 Disable mode

When selecting disabled operation mode, the device port can be disabled. The disable mode screen in [Figure 4-5-4](#) appears.

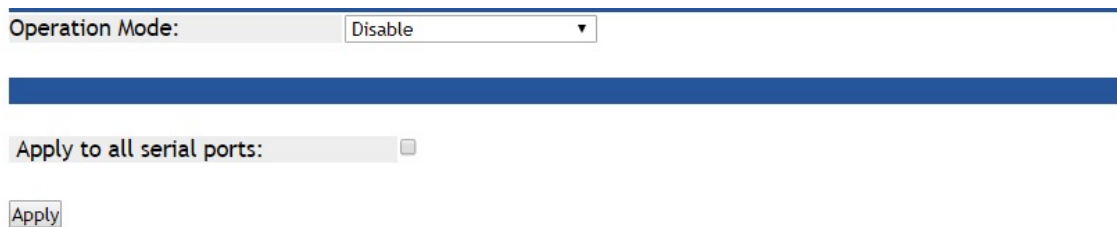

Figure 4-5-4: Disable Mode Screenshot

Object	Description
<ul style="list-style-type: none"> Apply to all serial ports 	To apply this configuration to all serial ports.

Buttons

Apply: Click to apply port config changes.



When applying any configuration changes of industrial serial server, it's required to **save changed configuration and reboot system**. Therefore the new configuration will be applied after rebooting.

4.5.2.2 Remote Pair Master/Slave mode

When a device connected to an industrial serial server can be transparently connected to another device on industrial serial server; data and modem control signals are exchanged. This protocol can overcome the limitations of traditional serial communication distances and introduce many new usability and feasibility for serial device control. In short, Remote Pair-Master/Slave mode provides tunnel-like functionality over the network. Only one Remote Pair-Slave can be connected to a remote pairing host. The remote pair master/slave topology in [Figure 4-5-5](#) appears.

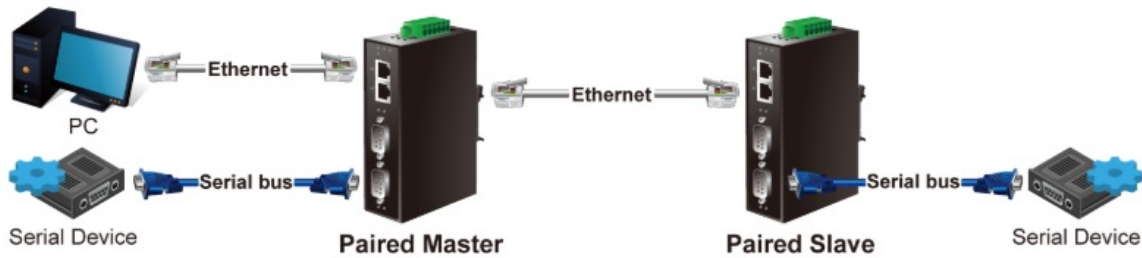

Figure 4-5-5: Remote Pair Master/Slave Topology

The remote pair master mode screenshot in [Figure 4-5-6](#) appears.

Operation Mode:	Remote Pair Master Mode
TCP Keep-alive Interval:	0 (min)
Target IP address:	: 5004

Figure 4-5-6: Remote Pair Master Mode Screenshot

The page includes the following fields:

Object	Description
<ul style="list-style-type: none"> • TCP Keep-alive Interval 	TCP keep alive interval shows how many seconds the unit waits during an inactive connection before checking its status. If the unit does not receive a response, it will drop that connection.
<ul style="list-style-type: none"> • Target IP address 	The Target IP address is the receiver of the message.

The remote pair slave mode screenshot in [Figure 4-5-7](#) appears.

Operation Mode:	Remote Pair Slave Mode
TCP Keep-alive Interval:	0 (min)
Local TCP Port:	5004

Figure 4-5-7: Remote Pair Slave Mode Screenshot

The page includes the following fields:

Object	Description
<ul style="list-style-type: none"> TCP Keep-alive Interval 	TCP keep alive interval shows how many seconds the unit waits during an inactive connection before checking its status. If the unit does not receive a response, it will drop that connection. The default is 0 minute.
<ul style="list-style-type: none"> Local TCP port 	This parameter describes the TCP port that communicates with the connected device. The setting slave and master destination IP parameters must use the same value to achieve communication. The range of value is from 1 to 65535. The default is 5004 for port 1, 5005 for port 2, 5006 for port 3 and 5007 for port 4

Using Remote Pair Connection mode for two RS-232 services for distance extension, the DB9/RS-232 cables are very important in this application. There are many different kinds of RS-232 cables, such as **straight cable** (standard) and **Null-Modem cable**. Please make sure the DB9/RS-232 cables match the following:

- **Serial Device to ICS-2X00/Remote (Slave)** – Use the original RS-232 serial cable attached in the serial device package.
- **Host / Client to ICS-2X00/Local (Master)** – It has to use the **Null-Modem cable!**

Users can use the Null-Modem cable to directly connect to the ICS-2X00 (Master), or use the Null-Modem DB9 connector, as the picture shows:



Once the Pair Connection mode of the ICS-2X00 is correctly configured but the link is still not connected, check the RS-232 cables.

4.5.2.3 RF2217 mode

RS232 to Ethernet Connector allows to choose the transmission protocol, supporting connections using either the RAW data transmission algorithm or the Telnet (RFC 2217) protocol. Therefore, Telnet can act as an interface to a network device server connected to a remote serial device. The RF2217 mode screenshot in [Figure 4-5-8](#) appears.

Operation Mode:	RFC 2217 Mode ▾	
TCP Keep-alive Interval:	0	(min)
Local TCP Port:	5004	
Frame Length:	0	(0 - 1300)
Separator:	00	(HEX) Enable: <input type="checkbox"/>
Separator Process:	Do Nothing ▾	
Separator Time Out:	0	(0 - 65535 ms)

Figure 4-5-8: RF2217 Mode Screenshot

The page includes the following fields:

Object	Description
• TCP Keep-alive Interval	TCP keep alive interval shows how many seconds the unit waits during an inactive connection before checking its status. If the unit does not receive a response, it will drop that connection. The default is 0 minute.
• Local TCP port	This parameter describes the TCP port that communicates with the connected device. The setting slave and master destination IP parameters must use the same value to achieve communication. The range of value is from 1 to 65535. The default is 5004 for port 1, 5005 for port 2, 5006 for port 3 and , 5007 for port 4
• Frame Length	This parameter can be used to control the data packet. When the device port is in the buffer until the specified data is accumulated, the data will be packed and transmitted by the network. This parameter is 0 to indicate that the data will not be packed until the buffer is full. The range of value is from 0 to 1024. The default is 0 .
• Separator	If the Separator is enabled, the serial receive character port will be discarded until the start separator is detected on the serial port. When the end separator is received, the buffered characters, including the start and end separators, are sent to the network. The range of value is from 0 to FF. The default is disable .
• Separator Process	Separators are ASCII characters specified by the user when configuring the serial serve. This parameter describes how to control characters received on a serial port are sent across the network. The default is Do nothing . <ul style="list-style-type: none"> ■ Do nothing: it will pack the accumulated data including Separators. ■ Strip Separator: it controls striping of Separator from the received characters before the received characters are sent to the network.
• Separator Time Out	Separator timeout controls the maximum amount of time that can be used to buffer characters before the characters are sent to the network. A smaller values will increase the number of network packets, but reduce the amount of time to receive characters, on the contrary, Larger values reduce the number of network packets, but increase the amount of time to receive characters. The range of value is from 0 to 65535. The default is 0 ms .

4.5.2.4 Serial Telnet mode

Telnet (TELEcommunication NETwork) is a network protocol used on the Internet or local area network (LAN) connections. The Telnet protocol type is the correct setting for most servers and serial devices, such as Managed Ethernet switches or Gateways. In the case of a Telnet session, the process is reversed, where the connected server reads and writes data to RS-232 serial port. Once the serial Telnet application is enabled, the industrial serial server will interact with these special CR/LF commands. The serial telnet mode topology in [Figure 4-5-9](#) appears.

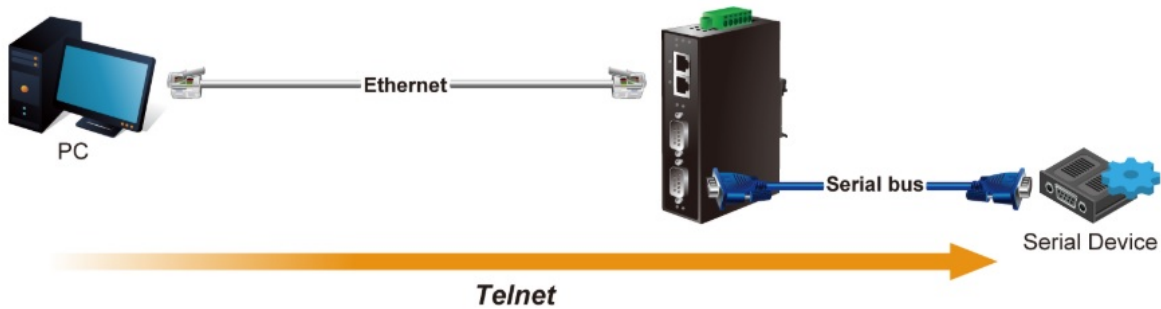

Figure 4-5-9: Serial Telnet Mode Topology

The serial Telnet mode screenshot in [Figure 4-5-10](#) appears.

Operation Mode:	Serial Telnet Mode ▾
TCP Keep-alive Interval:	0 (min)
Quiescent Time:	0 (0 - 65535 ms)
Local TCP Port:	5004
Translate CR-LF:	CR-LF ▾

Figure 4-5-10: Serial Telnet Mode Screenshot

Object	Description
<ul style="list-style-type: none"> TCP Keep-alive Interval 	TCP keep alive interval shows how many seconds the unit waits during an inactive connection before checking its status. If the unit does not receive a response, it will drop that connection. The default is 0 minute.
<ul style="list-style-type: none"> Quiescent Time 	When the network connection is determined to be idle, the duration of the control network inactivity will cause the connection to be forced closed. The range of value is from 1 to 65535 ms. The default is 0 ms
<ul style="list-style-type: none"> Local TCP port 	This parameter describes the TCP port that communicates with the connected device. The setting slave and master destination IP parameters must use the same value to achieve communication. The range of value is from 1 to 65535. The default is 5004 for port 1, 5005 for port 2, 5006 for port 3 and , 5007 for port 4
<ul style="list-style-type: none"> Translate CR-LF 	Enter CR-LF characters can be processed after industrial serial server. Just send CR, or LF, or do not modify CR-LF character. The default is CR-LF . <ul style="list-style-type: none"> ■ CR-LF ■ CR ■ LF

Example: Use Putty TCP/IP Winsock mode

PuTTY is a free implementation of Telnet and SSH for Win32 and Unix platforms, along with an xterm terminal emulator. In this case we use PuTTY to connect GS-5220-24P4XV managed switch via ICS-2400T.

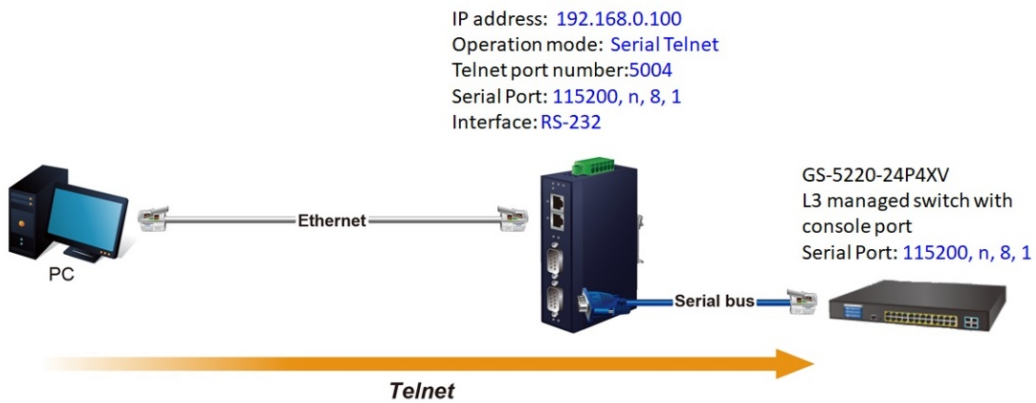

Figure 4-5-11: Serial Telnet Mode Application

ICS-2400T

1. Set Port Configuration as shown below.

Description:	<input type="text"/>	Baud Rate:	115200
Data Bits:	8	Any Baud Rate:	50 (50 - 921600)
Stop Bits:	1	Parity:	None
Interface:	RS-232	FlowControl:	None

Figure 4-5-12: Port Configuration

2. Set operation mode as **Serial Telnet mode**.
3. Run the Telnet software like "PuTTY" and set parameters as shown below:
- 4.

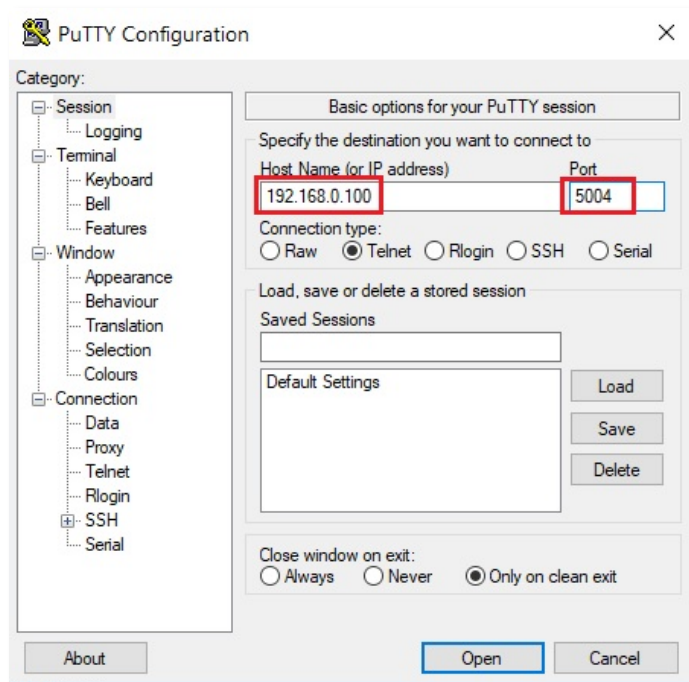

Figure 4-5-13: Putty Configuration

5. Then it can connect to switch successfully.

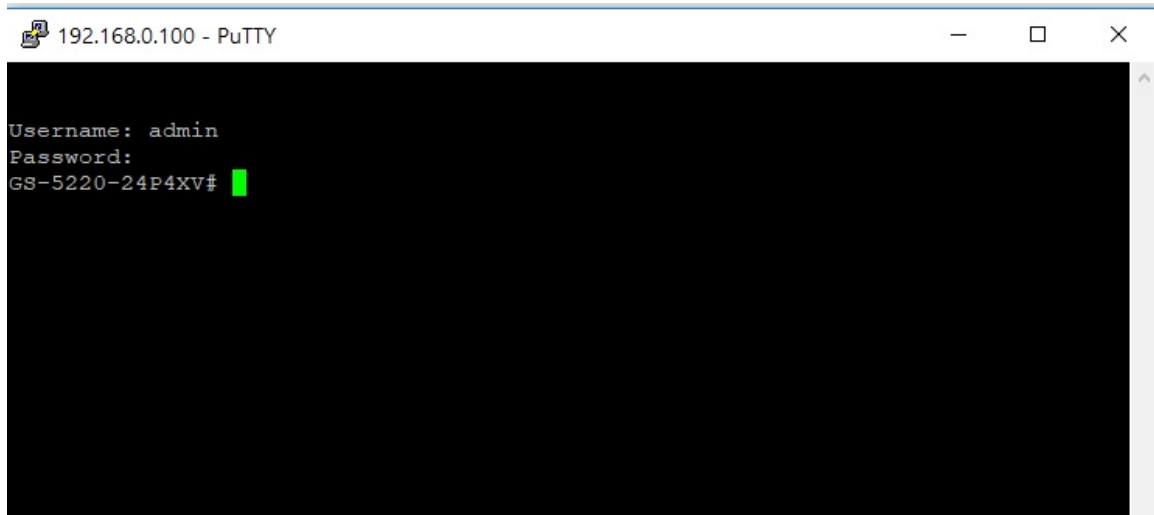

Figure 4-5-14: Putty Connection

4.5.2.5 TCP Server mode

When the serial server is configured as a TCP server, it waits for a connection initiated by another network device. User must set the local TCP port number for which it will listen for the connection, and the industrial serial server provides the maximum number of two concurrent connections. Incidentally, industrial serial server can be configured as a client or server. The TCP server mode topology in [Figure 4-5-115](#) appears.

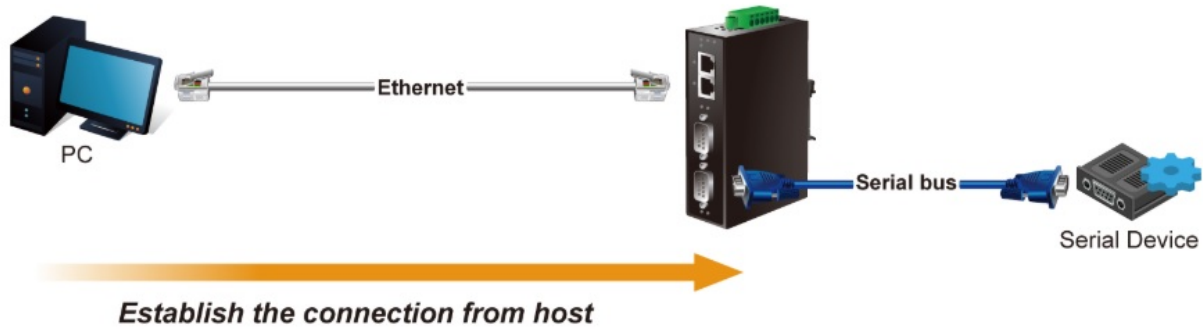

Figure 4-5-15: TCP Server Mode Topology

The TCP server mode screenshot in [Figure 4-5-16](#) appears.

Operation Mode:	TCP Server Mode	
TCP Keep-alive Interval:	0 (min)	
Quiescent Time:	0 (0 - 65535 ms)	
Max Connection:	1	
Local TCP Port:	5004	
Frame Length:	0 (0 - 1300)	
Separator:	00 (HEX)	Enable: <input type="checkbox"/>
Separator Process:	Do Nothing	
Separator Time Out:	0 (0 - 65535 ms)	

Figure 4-5-16: TCP Server Mode Screenshot

Object	Description
• TCP Keep-alive Interval	TCP keep alive interval shows how many seconds the unit waits during an inactive connection before checking its status. If the unit does not receive a response, it will drop that connection. The default is 0 minute.
• Quiescent Time	When the network connection is determined to be idle, the duration of the control network inactivity will cause the connection to be forcibly closed. The range of value is from 1 to 65535 ms. The default is 0 ms
• Max connection	This parameter set the TCP port number on which it will listen for the connection and set the maximum (up to two) acceptable number of connections. The range of value is from 1 to 4. The default is 1.
• Local TCP port	This parameter describes the TCP port that communicates with the connected device. The setting slave and master destination IP parameters must use the same value to achieve communication. The range of value is from 1 to 65535. The default is 5004 for port 1, 5005 for port 2, 5006 for port 3 and , 5007 for port 4
• Frame Length	This parameter can be used to control the data packet. When the device port is in the buffer until the specified data is accumulated, the data will be packed and transmitted by

	the network. This parameter is 0 to indicate that the data will not be packed until the buffer is full. The range of value is from 0 to 1024. The default is 0 .
• Separator	If the Separator is enabled, the serial receive character port will be discarded until the start separator is detected on the serial port. When the end separator is received, the buffered characters, including the start and end separators, are sent to the network. The range of value is from 0 to FF. The default is disable .
• Separator Process	Separators are ASCII characters specified by the user when configuring the serial serve. This parameter describes how to control characters received on a serial port are sent across the network. The default is Do nothing . <ul style="list-style-type: none"> ■ Do nothing: it will pack the accumulated data including Separators. ■ Strip Separator: it controls striping of Separator from the received characters before the received characters are sent to the network.
• Separator Time Out	Separator timeout controls the maximum amount of time that can be used to buffer characters before the characters are sent to the network. A smaller values will increase the number of network packets, but reduce the amount of time to receive characters, on the contrary, Larger values reduce the number of network packets, but increase the amount of time to receive characters. The range of value is from 0 to 65535. The default is 0 ms .

Example: Connect to Modbus sensor via TCP server mode

IP address: 192.168.0.100
Operation mode: TCP Server
Telnet port number: 5004
Serial Port: 9600, n, 8, 1
Interface: RS-485 2-wire



Figure 4-5-17: TCP Server Mode Application

ICS-2400T

1. Set Port Configuration as shown below.

Description:	<input type="text"/>	Baud Rate:	9600 ▾
Data Bits:	8 ▾	Any Baud Rate:	50 (50 - 921600)
Stop Bits:	1 ▾	Parity:	None ▾
Interface:	RS-485 2-Wire ▾	FlowControl:	None ▾

Figure 4-5-18: Port Configuration

2. Set operation mode as **Telnet Server mode**.

Operation Mode:	TCP Server Mode	
TCP Keep-alive Interval:	0	(min)
Quiescent Time:	0	(0 - 65535 ms)
Max Connection:	1	
Local TCP Port:	5004	
Frame Length:	0	(0 - 1300)
Separator:	00	(HEX) Enable: <input type="checkbox"/>
Separator Process:	Do Nothing	
Separator Time Out:	0	(0 - 65535 ms)

Figure 4-5-19: TCP Server Mode Configuration

- Run the modbus master application (e.g. Modbus Poll) and set parameters as shown below.

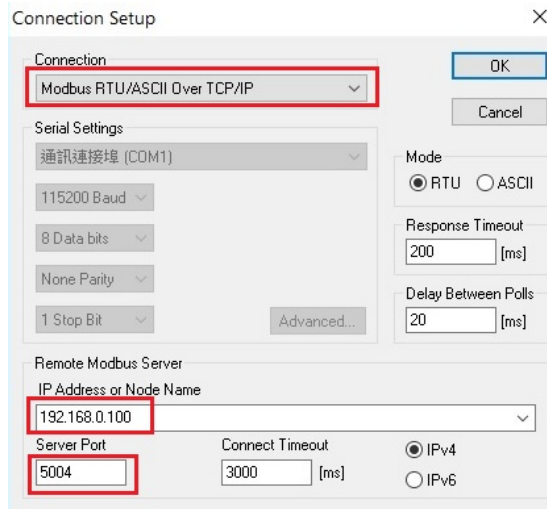

Figure 4-5-20: Modbus application Configuration

- Modbus master application (e.g. Modbus Poll) reads data from modbus sensor successfully.

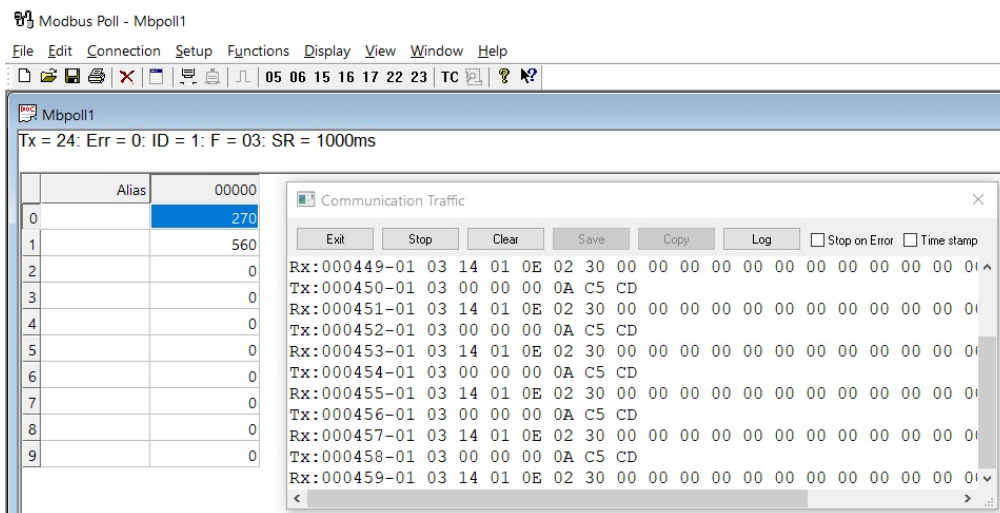

Figure 4-5-21: Modbus Connection

4.5.2.6 TCP Client mode

The TCP client initiates a connection to the server on the network. You must set up the target IP address and assigned local port number of server that you want the client to communicate with. In the data transmission phase, the data is transmitted to the destination in the order to which they are sent. INDUSTRIAL SERIAL SERVER device supports four sets of sequential connections. The TCP client mode topology in [Figure 4-5-22](#) appears.

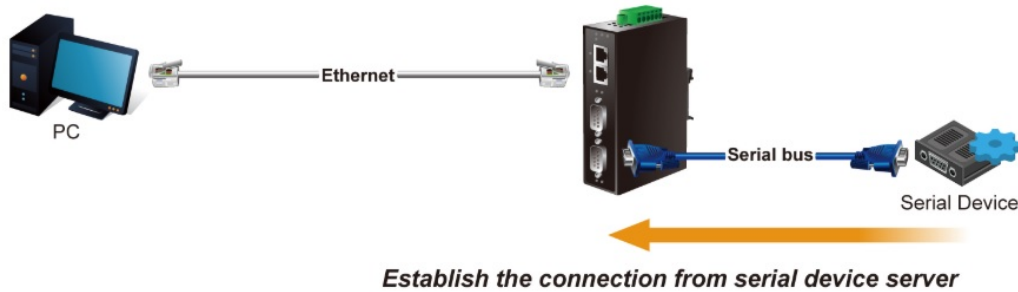

Figure 4-5-22: TCP Client Mode Topology

The TCP client mode screenshot in [Figure 4-5-23](#) appears.

Operation Mode:	TCP Client Mode		
TCP Keep-alive Interval:	0	(min)	
Quiescent Time:	0	(0 - 65535 ms)	
Frame Length:	0	(0 - 1300)	
Separator:	00	(HEX)	Enable <input type="checkbox"/>
Separator Process:	Do Nothing		
Separator Time Out:	0	(0 - 65535 ms)	

Connection Target IP Address			
Target IP 1:		:	5004
Target IP 2:		:	5004
Target IP 3:		:	5004
Target IP 4:		:	5004

Assigned Local Port (0 - 65535)			
Port 1:	5004	Port 2:	5004
Port 3:	5004	Port 4:	5004
Connection Control:	Startup/None (Connect on/Disconnect by)		

Figure 4-5-23: TCP Client Mode Screenshot

Object	Description
<ul style="list-style-type: none"> TCP Keep-alive Interval 	TCP keep alive interval shows how many seconds the unit waits during an inactive connection before checking its status. If the unit does not receive a response, it will drop that connection. The default is 0 minute.
<ul style="list-style-type: none"> Quiescent Time 	When the network connection is determined to be idle, the duration of the control network inactivity will cause the connection to be forced closed. The range of value is from 1 to 65535 ms. The default is 0 ms
<ul style="list-style-type: none"> Max connection 	This parameter set the TCP port number on which it will listen for the connection and set the maximum (up to two) acceptable number of connections. The range of value is from 1 to 4. The default is 1.
<ul style="list-style-type: none"> Local TCP port 	This parameter describes the TCP port that communicates with the connected device. The setting slave and master destination IP parameters must use the same value to

	achieve communication. The range of value is from 1 to 65535. The default is 5004 for port 1, 5005 for port 2, 5006 for port 3 and , 5007 for port 4.
• Frame Length	This parameter can be used to control the data packet. When the device port is in the buffer until the specified data is accumulated, the data will be packed and transmitted by the network. This parameter is 0 to indicate that the data will not be packed until the buffer is full. The range of value is from 0 to 1024. The default is 0 .
• Separator	If the Separator is enabled, the serial receive character port will be discarded until the start separator is detected on the serial port. When the end separator is received, the buffered characters, including the start and end separators, are sent to the network. The range of value is from 0 to FF. The default is disable .
• Separator Process	Separators are ASCII characters specified by the user when configuring the serial serve. This parameter describes how to control characters received on a serial port are sent across the network. The default is Do nothing . <ul style="list-style-type: none"> ■ Do nothing: it will pack the accumulated data including Separators. ■ Strip Separator: it controls striping of Separator from the received characters before the received characters are sent to the network.
• Separator Time Out	Separator timeout controls the maximum amount of time that can be used to buffer characters before the characters are sent to the network. A smaller values will increase the number of network packets, but reduce the amount of time to receive characters, on the contrary, Larger values reduce the number of network packets, but increase the amount of time to receive characters. The range of value is from 0 to 65535. The default is 0 ms .

Connection Target IP address

Object	Description
• Target IP address 1 through 4	IP addresses are used to deliver packets of data across a network and have what is termed end-to-end significance. The network data is sent to the device in a first-in, first-out (FIFO) method. During data transfer phase, data is transmitted sequentially through established path-arriving at the destination in the order in which it was sent.

Assign Local Port

Object	Description
• Local listen port	The range of value is from 1 to 65535. The default is 5004 for port 1, 5005 for port 2, 5006 for port 3 and , 5007 for port 4.
• Connection control	The default is Startup/None . <ul style="list-style-type: none"> ■ Startup/None ■ Any Character/None ■ Any Character/Quiescent time ■ DCD On/DCD Off ■ DCD On/None ■ DSR On/DSR Off ■ DSR On/None

4.5.2.7 UDP mode

UDP is a Connectionless of the non-reliable transmission protocol; it does not need to verify information and does not guarantee correctness for some of the larger amount of information. The reliability is greater than the reliability of transmission which is a good choice. UDP mode can allocate up to four ranges of IP. Each network output data is copied and sent to each IP for each range. The UDP mode topology in [Figure 4-5-24](#) appears.

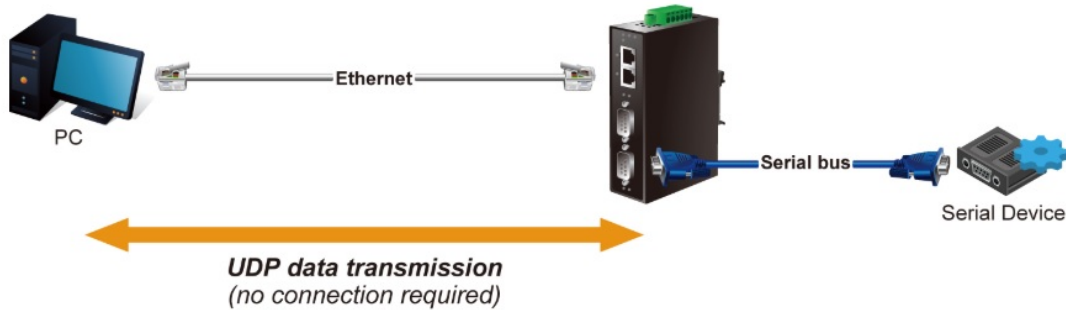

Figure 4-5-24: UDP Mode Topology

The UDP mode screenshot in [Figure 4-5-25](#) appears.

Operation Mode:	UDP Mode		
Local Listen Port:	5004		
Frame Length:	0	(0 - 1300)	
Separator:	00	(HEX)	Enable: <input type="checkbox"/>
Separator Process:	Do Nothing		
Separator Time Out:	0	(0 - 65535 ms)	

Connection Target IP Address			
Target IP 1:		: 5004	(0=Learning)
Target IP 2:		: 5004	(0=Learning)
Target IP 3:		: 5004	(0=Learning)
Target IP 4:		: 5004	(0=Learning)

Figure 4-5-25: UDP Mode Screenshot

Object	Description
<ul style="list-style-type: none"> TCP Keep-alive Interval 	TCP keep alive interval shows how many seconds the unit waits during an inactive connection before checking its status. If the unit does not receive a response, it will drop that connection. The default is 0 minute.
<ul style="list-style-type: none"> Local listen port 	The range of value is from 1 to 65535. The default is 5004 for port 1, 5005 for port 2, 5006 for port 3 and , 5007 for port 4.
<ul style="list-style-type: none"> Frame Length 	This parameter can be used to control the data packet. When the device port is in the buffer until the specified data is accumulated, the data will be packed and transmitted by the network. This parameter is 0 to indicate that the data will not be packed until the buffer is full. The range of value is from 0 to 1024. The default is 0 .
<ul style="list-style-type: none"> Separator 	If the Separator is enabled, the serial receive character port will be discarded until the start separator is detected on the serial port. When the end separator is received, the

	buffered characters, including the start and end separators, are sent to the network. The range of value is from 0 to FF. The default is disable .
<ul style="list-style-type: none"> • Separator Process 	<p>Separators are ASCII characters specified by the user when configuring the serial serve. This parameter describes how to control characters received on a serial port are sent across the network. The default is Do nothing.</p> <ul style="list-style-type: none"> ■ Do nothing: it will pack the accumulated data including Separators. ■ Strip Separator: it controls striping of Separator from the received characters before the received characters are sent to the network.
<ul style="list-style-type: none"> • Separator Time Out 	<p>Separator timeout controls the maximum amount of time that can be used to buffer characters before the characters are sent to the network. A smaller values will increase the number of network packets, but reduce the amount of time to receive characters, on the contrary, Larger values reduce the number of network packets, but increase the amount of time to receive characters. The range of value is from 0 to 65535 ms. The default is 0 ms.</p>

Connection Target IP address

Object	Description
<ul style="list-style-type: none"> • Target IP address 1 through 4 	<p>IP addresses are used to deliver packets of data across a network and have what is termed end-to-end significance. The network data is sent to the device in a first-in, first-out (FIFO) method. During data transfer phase, data is transmitted sequentially through established path-arriving at the destination in the order in which it was sent.</p>

4.5.2.8 Virtual COM mode

VCOM mode functionality provides a virtual-local COM port for Windows systems. The VCOM driver should be installed on the PC through the VCOM Administration Utility. The driver establishes a TCP connection to the connected serial device by mapping the local serial port to the IP port of the device port. VCOM mode also supports up to 256 mirroring ports at the same time, but must be in accordance with the computer resources. The Virtual COM mode topology in [Figure 4-5-26](#) appears.



Figure 4-5-26: Virtual COM Mode Topology

The Virtual COM mode screenshot in [Figure 4-5-27](#) appears.

Operation Mode:	VCOM Mode	Enable:	<input type="checkbox"/>
TCP Keep-alive Interval:	0 (min)		
Max Connection:	1		
Frame Length:	0 (0 - 1300)		
Separator:	00 (HEX)		
Separator Process:	Do Nothing		
Separator Time Out:	0 (0 - 65535 ms)		

Figure 4-5-27: Virtual COM Mode Screenshot

Object	Description
<ul style="list-style-type: none"> TCP Keep-alive Interval 	TCP keep alive interval shows how many seconds the unit waits during an inactive connection before checking its status. If the unit does not receive a response, it will drop that connection. The default is 0 minute.
<ul style="list-style-type: none"> Max connection 	This parameter set the TCP port number on which it will listen for the connection and set the maximum (up to two) acceptable number of connections. The range of value is from 1 to 4. The default is 1.
<ul style="list-style-type: none"> Frame Length 	This parameter can be used to control the data packet. When the device port is in the buffer until the specified data is accumulated, the data will be packed and transmitted by the network. This parameter is 0 to indicate that the data will not be packed until the buffer is full. The range of value is from 0 to 1024. The default is 0.
<ul style="list-style-type: none"> Separator 	If the Separator is enabled, the serial receive character port will be discarded until the start separator is detected on the serial port. When the end separator is received, the buffered characters, including the start and end separators, are sent to the network. The range of value is from 0 to FF. The default is disable .
<ul style="list-style-type: none"> Separator Process 	Separators are ASCII characters specified by the user when configuring the serial serve. This parameter describes how to control characters received on a serial port are sent across the network. The default is Do nothing .

	<ul style="list-style-type: none"> ■ Do nothing: it will pack the accumulated data including Separators. ■ Strip Separator: it controls striping of Separator from the received characters before the received characters are sent to the network.
<ul style="list-style-type: none"> • Separator Time Out 	<p>Separator timeout controls the maximum amount of time that can be used to buffer characters before the characters are sent to the network. A smaller values will increase the number of network packets, but reduce the amount of time to receive characters, on the contrary, Larger values reduce the number of network packets, but increase the amount of time to receive characters. The range of value is from 0 to 65535. The default is 0 ms.</p>

Example: Connect to Modbus sensor via Virtual COM mode

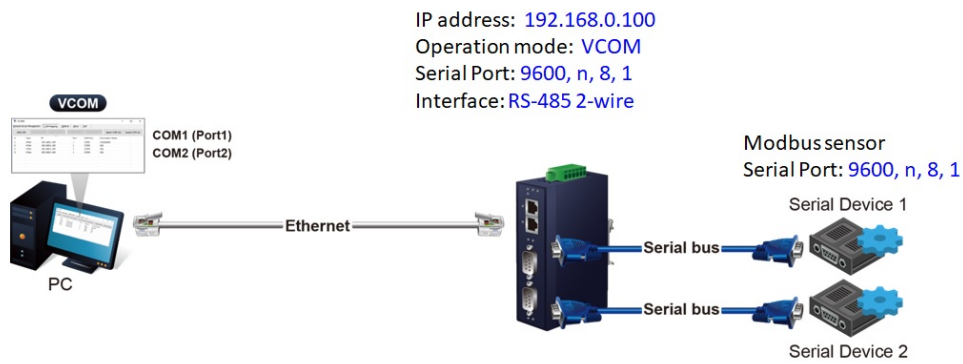

Figure 4-5-28: Virtual COM Mode Application

ICS-2400T

1. Set Port Configuration as shown below.

Description:	<input type="text"/>	Baud Rate:	9600 ▾
Data Bits:	8 ▾	Any Baud Rate:	50 (50 - 921600)
Stop Bits:	1 ▾	Parity:	None ▾
Interface:	RS-485 2-Wire ▾	FlowControl:	None ▾

Figure 4-5-29: Port Configuration

2. Set operation mode as **VCOM mode**.

Operation Mode:	VCOM Mode ▾		
TCP Keep-alive Interval:	0 (min)		
Max Connection:	1 ▾		
Frame Length:	0 (0 - 1300)		
Separator:	00 (HEX)	Enable:	<input type="checkbox"/>
Separator Process:	Do Nothing ▾		
Separator Time Out:	0 (0 - 65535 ms)		

Figure 4-5-30: VCOM Mode Configuration

- Run VCOM software to set port mapping. Port 1 is related to COM4 port.

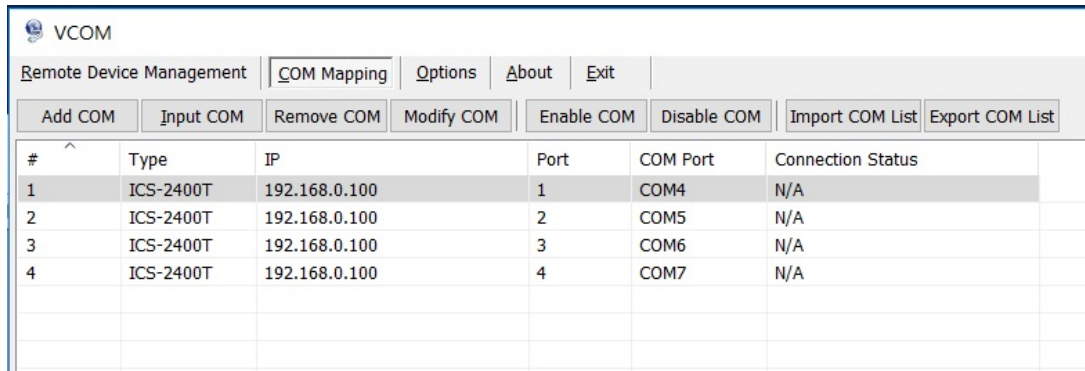

Figure 4-5-31: VCOM Software

- Run the modbus master application (e.g. Modbus Poll) and set parameters as shown below.

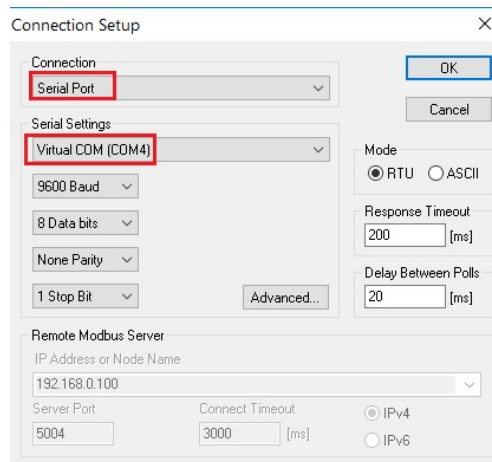

Figure 4-5-32: Modbus application Configuration

- Modbus master application (e.g. Modbus Poll) reads data from modbus sensor successfully.

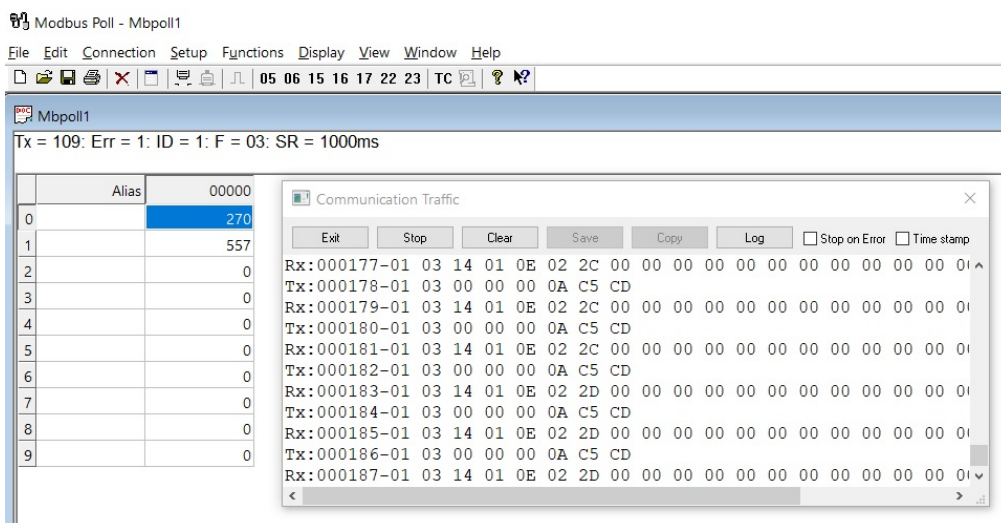

Figure 4-5-33: Modbus Poll Connection

4.5.2.9 Modbus Converter Server mode

The ICS Serial devices support standard Modbus protocol and various hardware interfaces (serial and Ethernet). Modbus TCP and RTU can be used to convert the Modbus protocol. The Modbus master can communicate with the serial network of devices connected to the serial port of the server converter via a server converter.

The meter receives Modbus TCP / IP data on TCP port 502, translates it to a Modbus RTU, and then forwards it to the addressed slave device.

Functionally allows monitoring software to access information from slaves for trend analysis, data collection, alarm/event management, maintenance and other functions. The Modbus Converter Server mode topology in [Figure 4-5-34](#) appears.

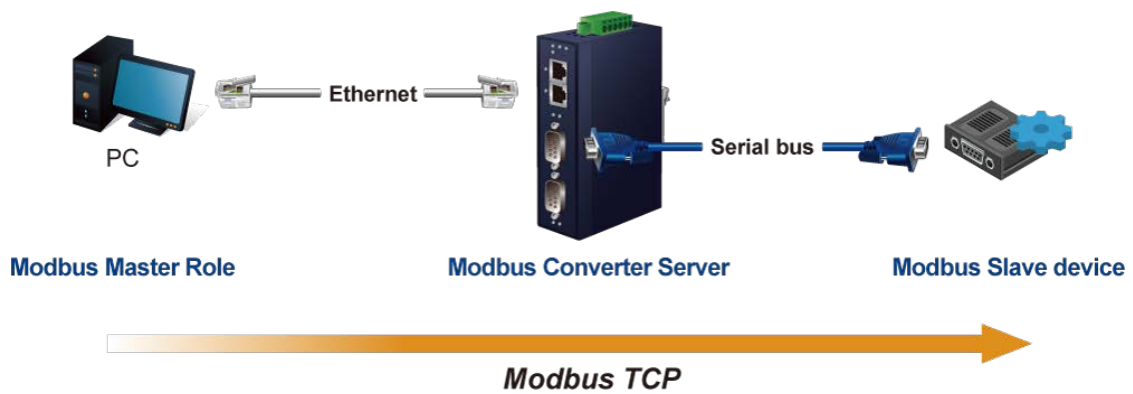

Figure 4-5-34: Modbus Converter Server mode Topology

The Modbus Converter Server mode screenshot in [Figure 4-5-35](#) appears.

Operation Mode:	Modbus Converter Server Mode ▾
TCP Keep-alive Interval:	0 (min)
Quiescent Time:	0 (0 - 65535 ms)
Max Connection:	1 ▾
Local TCP Port:	5004

Figure 4-5-35: Modbus Converter Server mode Screenshot

Object	Description
<ul style="list-style-type: none"> • TCP Keep-alive Interval 	TCP keep alive interval shows how many seconds the unit waits during an inactive connection before checking its status. If the unit does not receive a response, it will drop that connection. The default is 0 minute.
<ul style="list-style-type: none"> • Quiescent Time 	When the network connection is determined to be idle, the duration of the control network inactivity will cause the connection to be forced closed. The default value is 0.
<ul style="list-style-type: none"> • Max connection 	This parameter set the TCP port number on which it will listen for the connection and set the maximum (up to two) acceptable number of connections. The range of value is from 1 to 4. The default is 1.
<ul style="list-style-type: none"> • Local TCP Port 	Scope: 1 to 65535. Default: 5004 for port 1, 5005 for port 2 and so forth. This parameter is described the TCP port that communicates with the connected device. The setting slave and master destination IP parameters must use the same value to

	achieve communication.
--	------------------------

4.5.2.10 Modbus Converter Client mode

The ICS Serial devices support standard Modbus protocol and various hardware interfaces (serial and Ethernet). Modbus TCP and RTU can be used to convert the Modbus protocol. The Modbus master can communicate with the serial network of devices connected to the serial port of the server converter via a server converter.

The meter receives Modbus TCP / IP data on TCP port 502, translates it to a Modbus RTU, and then forwards it to the addressed slave device.

Functionally allows monitoring software to access information from slaves for trend analysis, data collection, alarm/event management, maintenance and other functions. The Modbus Converter Client topology in [Figure 4-5-36](#) appears.

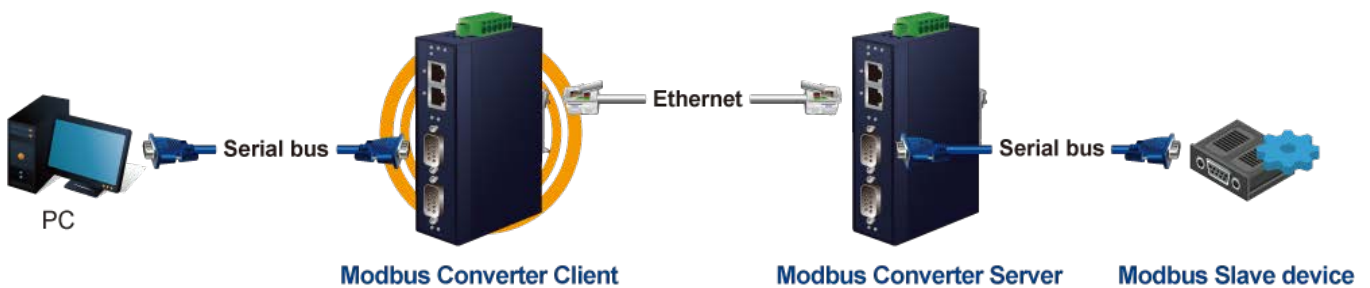

Figure 4-5-36: Modbus Converter Client mode Topology

The Modbus Converter Client mode screenshot in [Figure 4-5-37](#) appears.

Operation Mode:

TCP Keep-alive Interval: (min)

Quiescent Time: (0 - 65535 ms)

Connection Target IP Address	
Target IP 1:	<input type="text" value="5004"/>
Target IP 2:	<input type="text" value="5004"/>
Target IP 3:	<input type="text" value="5004"/>
Target IP 4:	<input type="text" value="5004"/>

Assigned Local Port (0 - 65535)	
Port 1:	<input type="text" value="5004"/>
Port 2:	<input type="text" value="5004"/>
Connection Control:	<input type="text" value="Startup/None"/> (Connect on/Disconnect by)

Figure 4-5-37: Modbus Converter Client mode Screenshot

Object	Description
<ul style="list-style-type: none"> TCP Keep-alive Interval 	TCP keep alive interval shows how many seconds the unit waits during an inactive connection before checking its status. If the unit does not receive a response, it will drop that connection. The default is 0 minute.
<ul style="list-style-type: none"> Quiescent Time 	When the network connection is determined to be idle, the duration of the control network inactivity will cause the connection to be forced closed. The default value is 0.

Connection Target IP address

Object	Description
<ul style="list-style-type: none"> • Target IP address 1 through 4 	<p>IP addresses are used to deliver packets of data across a network and have what is termed end-to-end significance. The network data is sent to the device in a first-in, first-out (FIFO) method. During data transfer phase, data is transmitted sequentially through established path-arriving at the destination in the order in which it was sent.</p>

Assign Local Port

Object	Description
<ul style="list-style-type: none"> • Local listen port 	<p>The range of value is from 1 to 65535. The default is 5004 for port 1, 5005 for port 2, 5006 for port 3 and , 5007 for port 4.</p>
<ul style="list-style-type: none"> • Connection control 	<p>The default is Startup/None.</p> <ul style="list-style-type: none"> ■ Startup/None ■ Any Character/None ■ Any Character/Quiescent time ■ DCD On/DCD Off ■ DCD On/None ■ DSR On/DSR Off ■ DSR On/None

4.6 SNMP Setup

Use the Port Menu to display or configure the Industrial Industrial Serial Server's ports. This section includes the page that displays current port configurations. Ports can also be configured here. The Port Configuration screen in [Figure 4-6-1](#) appears.

SNMP Setup

SNMP Active:	Disable ▾
Community:	public
Contact:	defaultContact
Location:	defaultLocation
Trap Server:	localhost IP or domain name

Events:	
Cold Start Trap:	<input type="checkbox"/>
Warm Start Trap:	<input type="checkbox"/>
Authentication Failure Trap:	<input type="checkbox"/>

Figure 4-6-1: SNMP Setup page Screenshot

The page includes the following fields:

Object	Description
• SNMP Active	Indicates the SNMP mode operation. Possible modes are: <ul style="list-style-type: none"> ■ Disable: Disable SNMP mode operation. ■ Enable: Enable SNMP mode operation.
• Community	Indicates the security name to map the community to the SNMP Groups configuration.
• Contact	The textual identification of the contact person for this managed node, together with information on how to contact this person.
• Location	The physical location of this node (e.g., telephone closet, 3rd floor).
• Trap Server	Indicates the SNMP trap destination address. It allows a valid IP address or domain name.

Events

Object	Description
• Cold Start Trap	This event is triggered when the power is interrupted and restarted.
• Warm Start Trap	This event occurs when the device is reset but does not turn off the power.
• Authentication Failure Trap	This event occurs when an incorrect or unauthorized password are entered.

4.7 Maintenance

Use the Port Menu to display or configure the Industrial Industrial Serial Server's ports. This section includes the page that displays current port configurations. Ports can also be configured here.

4.7.1 Change Password

After logging in to the industrial serial server, user can make changes from the "Change Password" page. The Change Password screen in [Figure 4-7-1](#) appears.

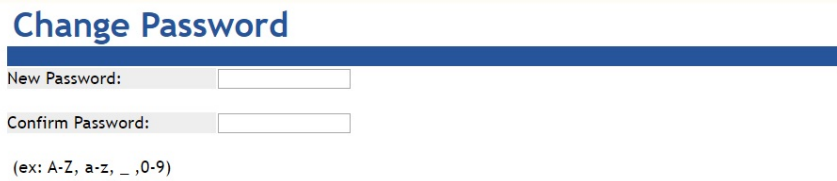

Figure 4-7-1: Change Password Page Screenshot

The page includes the following fields:

Object	Description
<ul style="list-style-type: none"> New Password 	A new password. It allows strings like A-Z, a-z, _ ,0-9
<ul style="list-style-type: none"> Confirm Password 	Please enter the user's new password here again to confirm.

4.7.2 Load Default

A user can reset the configuration of the industrial serial server on this page. The new configuration will be applied after restarting the system. The Load Default screen in [Figure 4-7-2](#) appears.

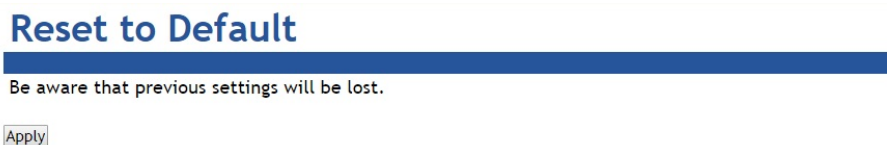

Figure 4-7-2: Reset to Default Page Screenshot

Buttons

Apply: Click to reset to default.

4.7.3 Firmware Update

This page facilitates an update of the firmware controlling the switch. The Firmware Update screen in [Figure 4-7-3](#) appears.

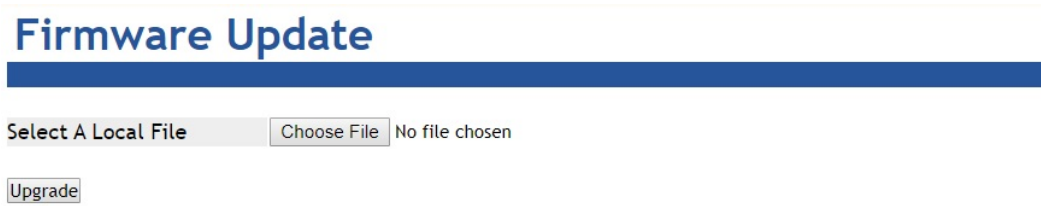

Figure 4-7-3: Firmware Update Page Screenshot

To open **Firmware Update** screen, perform the following:

1. Click **Maintenance -> Firmware Update**.
2. The Firmware Update screen is displayed as in [Figure 4-7-3](#).
3. Click the "**Choose File**" button of the Main page; the file selection menu pops up for you to choose firmware.
4. Select on the firmware, then click "**Upgrade**"; the **Software Upload Progress** would show the file with upload status.
5. Once the software is loaded to the system successfully, the following screen [Figure 4-7-4](#) appears. The system will load the new software after rebooting.

Information Note

Please wait while ...
System will reboot automatically after finished.

100 % , Rebooting ... 94 seconds

Figure 4-7-4: Rebooting Screenshot

4.8 Save and Restart

When applying any configuration changes of industrial serial server, it's required to save changed configuration and reboot system. Therefore the new configuration will be applied after rebooting. The Save and Restart screen in [Figure 4-8-1](#) appears.

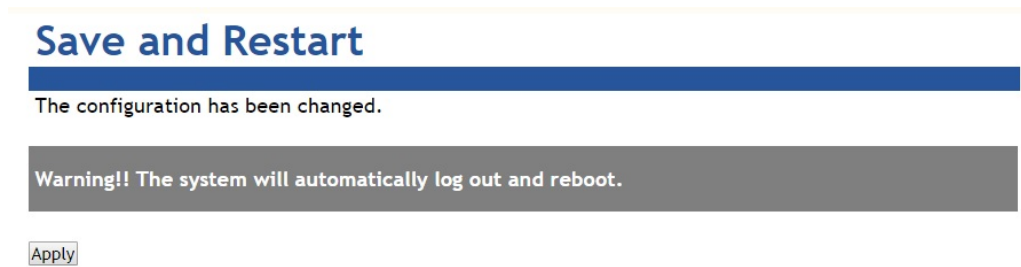



Figure 4-8-1 : Save and Restart Page Screenshot

Buttons

: Click to save changes and restart ststem.

5. SOFTWARE VCOM UTILITY

The industrial serial server provides VCOM software to manage serial devices. With VCOM software, it's easy to install and configure industrial serial server over the network. It also supports central management to manage multiple serial servers from one site.

Two function groups are provided and they are easy to use for searching device and creating virtual COM to view via the console port. VCOM software can search ICS-2100T, ICS-2105AT, ICS-2200T and ICS-2400T devices; it will show information of the device. And user can use VCOM function to create virtual COM port for users. Users can send data via virtual COM port, and virtual COM port will transfer data to Ethernet by windows socket. When VCOM gets data from Ethernet, data will be transferred to virtual COM port by virtual COM component.

5.1 Installing the VCOM Utility

1. When you run VCOM installer, a welcome window will appear as shown in [Figure 5-1-1](#). Click Next to continue.

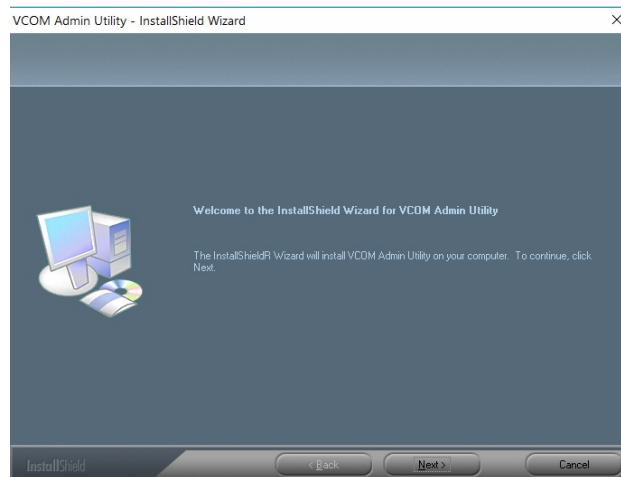

Figure 5-1-1 : Installing the VCOM Utility

2. Click Next to accept suggested installation path, or click browse to select a different location as shown in [Figure 5-1-2](#).

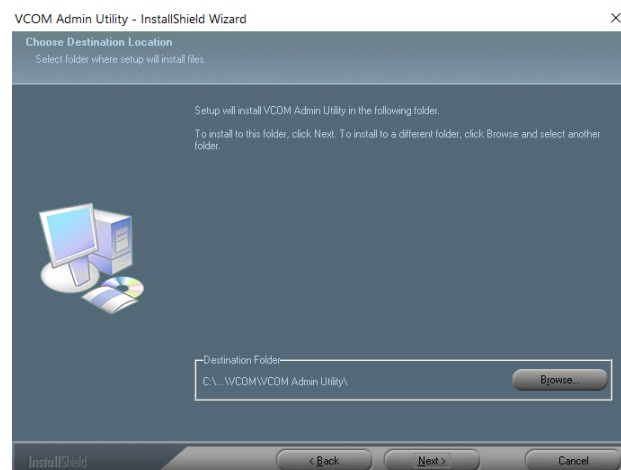

Figure 5-1-2 : Installing location

3. The setup wizard will show the progress of the installation and status as shown in [Figure 5-1-3](#).

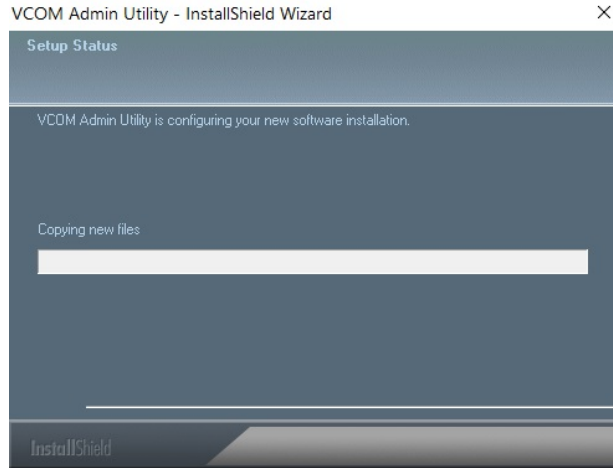

Figure 5-1-3 : Installing Process

4. Click Finish to successfully complete installation of VCOM software.as shown in [Figure 5-1-4](#).

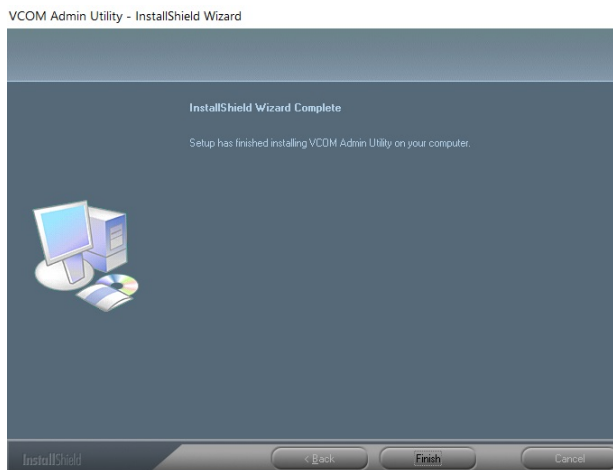

Figure 5-1-4 : Installation Finished

5. Restart computer as shown in [Figure 5-1-5](#).

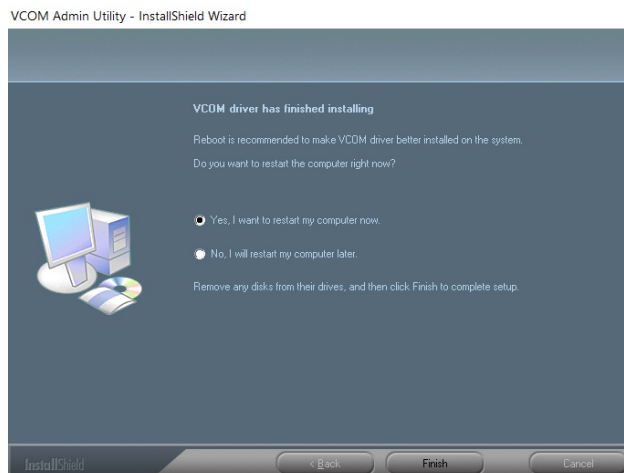

Figure 5-1-5 : Restart System

5.2 Search Devices

1. First click "Add Device" and then click "Search", if device has access to network, as shown in [Figure 5-2-1](#).

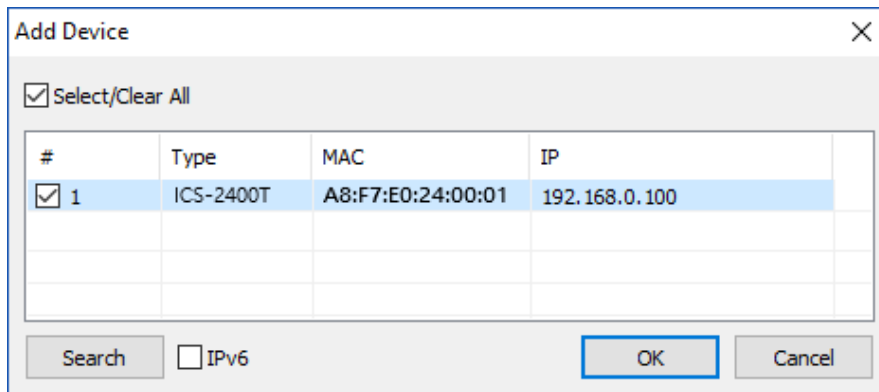

Figure 5-2-1 : Searching Devices

2. After adding an ICS-2400T device as shown in [Figure 5-2-2](#).

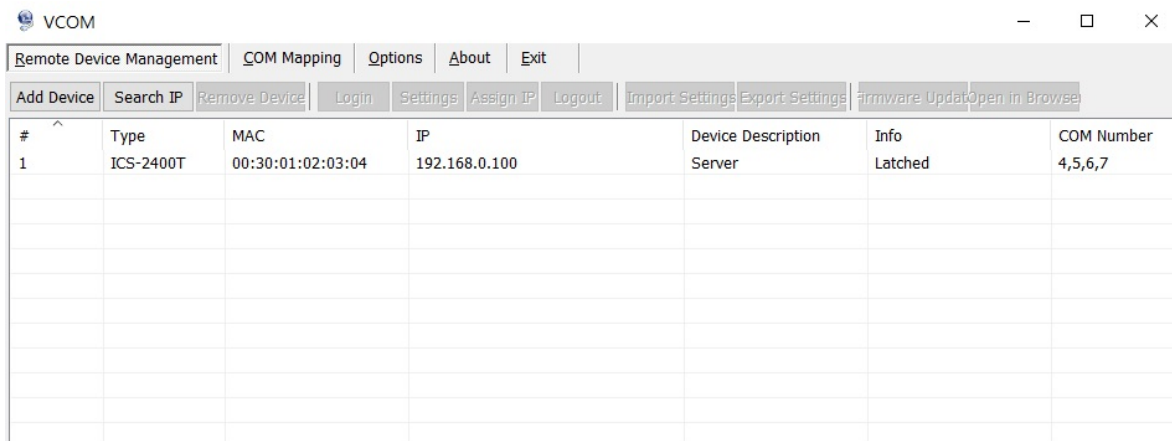

Figure 5-2-2: A device successfully added

5.3 Virtual COM

This function should be set as **VCOM mode** on the industrial serial server. VCOM software will create the corresponding virtual COM ports for com port mapping as shown in [Figure 5-3-1](#).

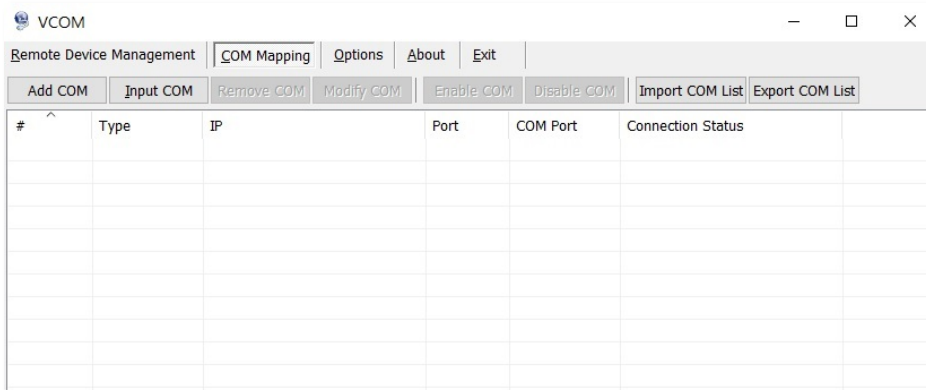

Figure 5-3-1 : VCOM software

Add Virtual COM port

1. Click "Search" to search the network for industrial device servers.
2. Once a server has been found, select it to add it to the COM mapping list and Click "OK" to take effect as shown in [Figure 5-3-3](#).

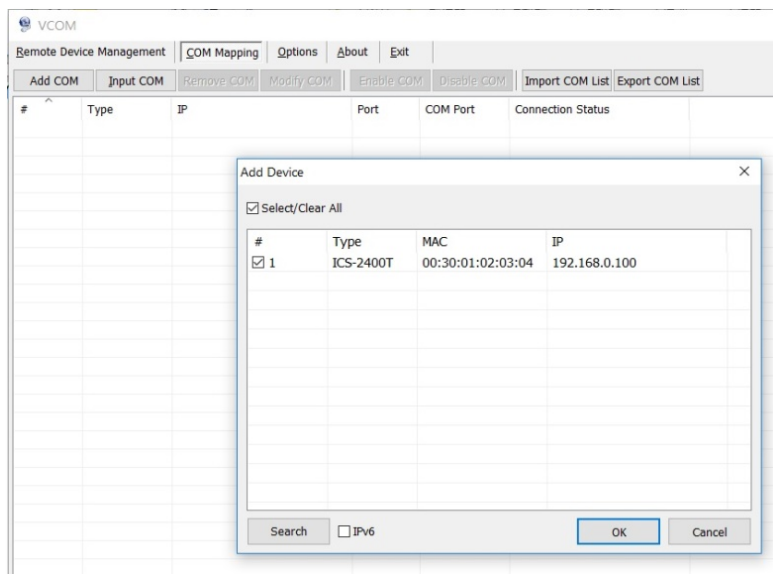

Figure 5-3-2 : VCOM software

3. Virtual com ports are generated as shown in [Figure 5-3-3](#).

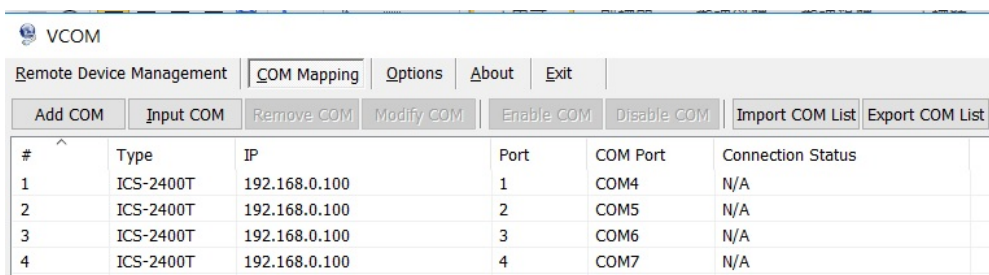

Figure 5-3-3 : Virtual COM Ports

4. From the Windows Device Manager, four COM Ports are added to the device list as shown in [Figure 5-3-4](#).

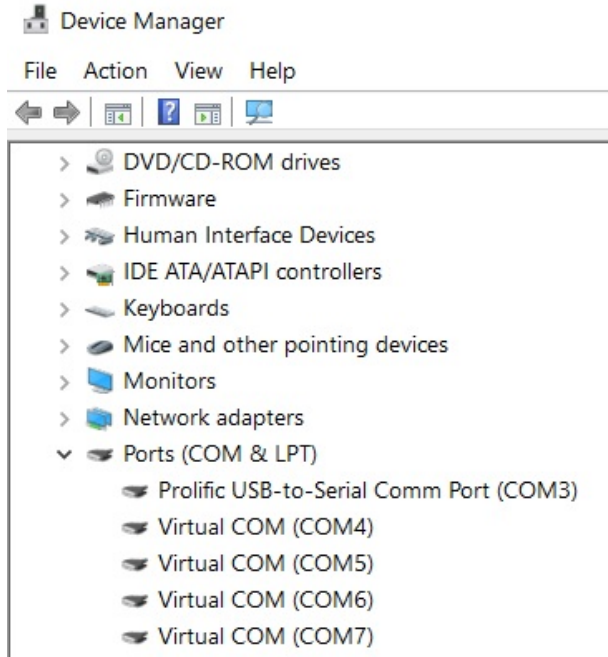

Figure 5-3-4 : Virtual COM Ports