

LoRaWAN Sensors

LS100/LS200 Series

User's Manual

Table of Contents

1. Product Introduction	5
1.1 Package Contents	6
1.2 Overview	6
1.3 Features	8
1.4 Product Specifications	10
2. Hardware Introduction	16
2.1 Physical Descriptions	16
2.2 Hardware Installation	20
2.2.1 Battery Installation.....	20
2.2.2 Magnetic Mounting or Wall Mounting.....	21
2.3.2 Precautions.....	24
3. Preparation	28
3.1 Requirements	28
3.2 LoRaWAN Gateway Setup	28
3.2.1 LoRa Frequency Setting.....	28
3.2.2 LoRaWAN Setting.....	29
3.2.3 Setting Up of LoRa Connection via ABP Decryption	30
4. Customer Support	32

Copyright

Copyright (C) 2023 PLANET Technology Corp. All rights reserved.

The products and programs described in this User's Manual are licensed products of PLANET Technology, This User's Manual contains proprietary information protected by copyright, and this User's Manual and all accompanying hardware, software, and documentation are copyrighted.

No part of this User's Manual may be copied, photocopied, reproduced, translated, or reduced to any electronic medium or machine-readable form by any means, electronic or mechanical including photocopying, recording, or information storage and retrieval systems, for any purpose other than the purchaser's personal use, and without the prior express written permission of PLANET Technology.

Disclaimer

PLANET Technology does not warrant that the hardware will work properly in all environments and applications, and makes no warranty and representation, either implied or expressed, with respect to the quality, performance, merchantability, or fitness for a particular purpose.

PLANET has made every effort to ensure that this User's Manual is accurate; PLANET disclaims liability for any inaccuracies or omissions that may have occurred. Information in this User's Manual is subject to change without notice and does not represent a commitment on the part of PLANET. PLANET assumes no responsibility for any inaccuracies that may be contained in this User's Manual. PLANET makes no commitment to update or keep current the information in this User's Manual, and reserves the right to make improvements and/or changes to this User's Manual at any time without notice.

If you find information in this manual that is incorrect, misleading, or incomplete, we would appreciate your comments and suggestions.

FCC Compliance Statement

This Equipment has been tested and found to comply with the limits for a Class A digital device, pursuant to Part 15 of the FCC rules. These limits are designed to provide reasonable protection against harmful interference in a residential installation. This equipment can radiate radio frequency energy and, if not installed and used in accordance with the instructions, may cause harmful interference to radio communications.

However, there is no guarantee that interference will not occur in a particular installation. If this equipment does cause harmful interference to radio or television reception, which can be determined by turning the equipment off and on, the user is encouraged to try to correct the interference by one or more of the following measures:

- Reorient or relocate the receiving antenna.
- Increase the separation between the equipment and receiver.
- Connect the equipment into an outlet on a circuit different from that to which the receiver is connected.
- Consult the dealer or an experienced radio/TV technician for help.

CE mark Warning

 This equipment is compliant with Class A of CISPR 32. In a residential environment this equipment may cause radio interference.

WEEE



To avoid the potential effects on the environment and human health as a result of the presence of hazardous substances in electrical and electronic equipment, end users of electrical and electronic equipment should understand the meaning of the crossed-out wheeled bin symbol. Do not dispose of WEEE as unsorted municipal waste and have to collect such WEEE separately.

Trademarks

The PLANET logo is a trademark of PLANET Technology. This documentation may refer to numerous hardware and software products by their trade names. In most, if not all cases, these designations are claimed as trademarks or registered trademarks by their respective companies.

Revision

User's Manual of PLANET LoRaWAN Sensors

Model: **LS100 series** (LS100-WL, LS100-PIR, and LS100-DW) and **LS200 series** (LS200-TH, LS200-PT, LS200-TC, LS200-RF, LS200-LG, and LS200-CM3)

Rev.: 1.0 (December 2023)

Part No. EM-LS100 Series_ LS200 Series v1.0

1. Product Introduction

Thank you for purchasing PLANET LoRaWAN Sensor, LS series. The descriptions of these models are as follows:

■ EU868

LS100-WL-EU868	IP65 LoRaWAN Water Leak Sensor (EU868 Sub 1G)
LS100-PIR-EU868	IP30 LoRaWAN Indoor Occupancy Sensor (Occupancy/Light/Temperature -20~55 degrees C, EU868 Sub 1G)
LS100-DW-EU868	IP30 LoRaWAN Door and Window Sensor (EU868 Sub 1G)
LS200-TH-EU868	IP65 LoRaWAN Indoor Temperature and Humidity Sensor (-20~55 degrees C, EU868 Sub 1G)
LS200-PT-EU868	IP65 LoRaWAN Product Temperature Sensor (PT1000 Needle Probe -70~200 degrees C, EU868 Sub 1G)
LS200-TC-EU868	IP65 LoRaWAN Machine Temperature Sensor (Thermocouple -40~125 degrees C, EU868 Sub 1G)
LS200-RF-EU868	IP65 LoRaWAN Refrigerator Temperature and Humidity Sensor (-40~55 degrees C, EU868 Sub 1G)
LS200-LG-EU868	IP65 LoRaWAN Light Level Sensor (EU868 Sub 1G)
LS200-CM3-EU868	IP53 LoRaWAN 3-phase Current Meter (3 x 75A Clamp-On CT, EU868 Sub 1G)

■ US915

LS100-WL-US915	IP65 LoRaWAN Water Leak Sensor (US915 Sub 1G)
LS100-PIR-US915	IP30 LoRaWAN Indoor Occupancy Sensor (Occupancy/Light/Temperature -20~55 degrees C, US915 Sub 1G)
LS100-DW-US915	IP30 LoRaWAN Door and Window Sensor (US915 Sub 1G)
LS200-TH-US915	IP65 LoRaWAN Indoor Temperature and Humidity Sensor (-20~55 degrees C, US915 Sub 1G)
LS200-PT-US915	IP65 LoRaWAN Product Temperature Sensor (PT1000 Needle Probe -70~200 degrees C, US915 Sub 1G)
LS200-TC-US915	IP65 LoRaWAN Machine Temperature Sensor (Thermocouple -40~125 degrees C, US915 Sub 1G)

LS200-RF-US915	IP65 LoRaWAN Refrigerator Temperature and Humidity Sensor (-40~55 degrees C, US915 Sub 1G)
LS200-LG-US915	IP65 LoRaWAN Light Level Sensor (US915 Sub 1G)
LS200-CM3-US915	IP53 LoRaWAN 3-phase Current Meter (3 x 75A Clamp-On CT, US915 Sub 1G)

“LoRaWAN Sensor” mentioned in the manual refers to the above models.

1.1 Package Contents

The package should contain the following:

Model	Package Contents
LS100-WL	LoRaWAN Water Leak Sensor x 1
LS100-PIR	LoRaWAN Indoor Occupancy Sensor x 1
LS100-DW	LoRaWAN Door and Window Sensor x 1
LS200-TH	LoRaWAN Indoor Temperature and Humidity Sensor x 1
LS200-PT	LoRaWAN Product Temperature Sensor x 1
LS200-TC	LoRaWAN Machine Temperature Sensor x 1
LS200-RF	LoRaWAN Refrigerator Temperature and Humidity Sensor x 1
LS200-LG	LoRaWAN Light Level Sensor x 1
LS200-CM3	LoRaWAN 3-phase Current Meter x 1



Note

If any of the above items are missing, please contact your dealer immediately.

1.2 Overview

Build a Smart IoT Environment with Fabulous LoRaWAN Sensors

PLANET LS100 and LS 200 LoRaWAN sensors are intended for environmental monitoring and data collection. Data such as temperature, humidity, illumination, and ingress/egress all impact the status of a facility or a device,

whether it is a motor, a refrigeration unit, or even the networking gear itself. Sensors in the LS series mostly have IP65 and IP67 ratings, allowing them to be deployed in outdoor and industrial indoor environments. The number of sensors deployed depends on network requirements. The sensor(s) can monitor a wide variety of conditions, including humidity, leak detection, room temperature, machine temperature, product temperature, ingress and egress, lighting, occupancy and asset location. These battery-operated sensors with no wiring required are easy to install in any place.

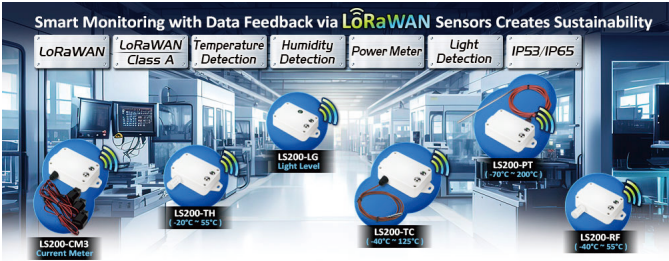

LoRa and LoRaWAN Wireless Technology

LoRa is a low-power, wide area network (LPWAN) RF modulation technology. It standardizes LPWANs and enables extremely long-range data links. With a range of up to three miles (five kilometers) in urban areas and over 10 miles (15 kilometers) in rural areas (line of sight), LoRa is ideal for creating networks that require long-range or deep in-building communication. A key feature is its ultra-low power requirements, enabling the deployment of battery-operated devices that can last up to several years. Using the open LoRaWAN protocol in a star topology, it's suitable for applications with numerous low-power devices collecting small amounts of data. The LS series is ideal for LoRa-enabled devices in the IoT system.

LoRaWAN-based Controller with Rich Industrial Interfaces

PLANET LoRaWAN Sensor is fully compatible with standard LoRaWAN gateways like PLANET LCG-300 series, supporting the LoRaWAN class A. It is ideal for large-scale IoT applications, including building automation, smart metering, HVAC systems, agriculture, and more. The sensor facilitates the seamless integration of multiple sensors, making it a perfect choice for retrofitting legacy assets into IoT-enabled systems.

- LS100-WL
IP65 LoRaWAN Water Leak Sensor
- LS100-PIR
IP30 LoRaWAN Indoor Occupancy Sensor
- LS100-DW
IP30 LoRaWAN Door and Window Sensor
- LS200-TH
IP65 LoRaWAN Indoor Temperature and Humidity Sensor
- LS200-PT
IP65 LoRaWAN Product Temperature Sensor
- LS200-TC
IP65 LoRaWAN Machine Temperature Sensor
- LS200-RF
IP65 LoRaWAN Refrigerator Temperature and Humidity Sensor
- LS200-LG
IP65 LoRaWAN Light Level Sensor
- LS200-CM3
IP53 LoRaWAN 3-phase Current Meter

1.3 Features

Key Features

- LS100-WL
 - Water Leak Sensor
 - IP65 rating
 - LoRaWAN™ Class A compatible
- LS100-PIR

- Indoor Occupancy Sensor (Occupancy/Light/Temperature)
- IP30 rating
- LoRaWAN™ Class A compatible
- LS100-DW
 - Door and Window contact Sensor
 - IP30 rating
 - LoRaWAN™ Class A compatible
- LS200-TH
 - Indoor Temperature and Humidity Sensor (-20~55 degrees C)
 - IP65 rating
 - LoRaWAN™ Class A compatible
- LS200-PT
 - Product Temperature Sensor with PT1000 Needle Probe (-70~200 degrees C)
 - IP65 rating
 - LoRaWAN™ Class A compatible
- LS200-TC
 - Machine Temperature Sensor with Thermocouple (-40~125 degrees C)
 - IP65 rating
 - LoRaWAN™ Class A compatible
- LS200-RF
 - Refrigerator Temperature and Humidity Sensor (-40~55 degrees C)
 - IP65 rating
 - LoRaWAN™ Class A compatible
- LS200-LG
 - Light Level Sensor
 - IP65 rating
 - LoRaWAN™ Class A compatible
- LS200-CM3
 - 3-phase Current Meter with Clamp-On CT
 - Measure 75A current maximum
 - IP53 rating
 - LoRaWAN™ Class A compatible

1.4 Product Specifications

■ LS100 series

Product	LS100-WL	LS100-PIR	LS100-DW
Wireless Transmission			
Technology	LoRaWAN		
Frequency	EU868: 863–870 MHz US915: 902–928 MHz		
TX Power	US915 20dbm AS923 16dbm (optional) AU915 20dbm (optional)	EU868 16dbm KR920 14dbm (optional) IN865 20dbm (optional)	
Rx Sensitivity	-136dBm (LoRa, Spreading Factor = 12, Bitrate = 293bps) -121dBm (FSK, Frequency Deviation = 5kHz, Bitrate = 1.2kbps)		
Work Mode	OTAA/ABP Class A		
Data Interfaces			
Power Supply	2 x 3.6V ER14505 AA battery in parallel (Battery not included)		2 x 3.0V CR2450 button battery (Battery not included)
Operating Voltage	DC 3.1V~3.65V	DC 3.1V~3.65V	DC 2.4V~3V
Battery Life Time	5 years (25°C, 15-minute reports, TxPower=20dBm, SF10)		3 years (25°C, 15-minute reports, TxPower=20dBm, SF10)
Standby Current	22uA	110uA	12uA
Wake-up Current (Typical value)	7.12mA	9.78mA	120mA/11mA
Low Battery Threshold	3.2V	3.2V	2.4V

Physical Characteristics			
Dimensions (L x W x H)	112 x 88.2 x 32 mm	78 x 78.8 x 82.2 mm	57 x 38.05 x 15.2 mm 42.5 x 13 x 12 mm (Magnet)
Weight	141g	125.8g	43.8g
Sensor Dimensions (L x W x H)	38.5 x 11.89 x 13.7 mm	-	-
Ingress Protection	IP65	IP30	IP30
Operating Temperature	-20°C to 55°C		
Relative Humidity	<90% RH (non condensing)		
Storage Temperature	-40°C~85°C		
Standards Conformance			
Regulatory Compliance	CE RED, FCC PART 15B	FCC Part 15B	FCC Part 15B

■ LS200 series (1/2)

Product	LS200-TH	LS200-PT	LS200-TC
Wireless Transmission			
Technology	LoRaWAN		
Frequency	EU868: 863-870 MHz US915: 902-928 MHz		
TX Power	US915 20dbm AS923 16dbm (optional) AU915 20dbm (optional)	EU868 16dbm KR920 14dbm (optional) IN865 20dbm (optional)	
Rx Sensitivity	-136dBm (LoRa, Spreading Factor = 12, Bitrate = 293bps) -121dBm (FSK, Frequency Deviation = 5kHz, Bitrate = 1.2kbps)		
Work Mode	OTAA/ABP Class A		
Data Interfaces			
Power Supply	2 x 3.6V ER14505 AA battery in parallel (Battery not included)		
Operating Voltage	DC 3.1V~3.65V	DC 3.1V~3.65V	DC 3.1V~3.65V
Battery Life Time	5 years (25°C, 15-minute reports, TxPower=20dBm, SF10)		4.8 Years (25°C, 15-minute reports, TxPower=20dBm, SF10)
Standby Current	24uA	25uA	34uA
Wake-up Current (Typical value)	6.99mA	9.94mA	7.33mA
Low Battery Threshold	3.2V	3.2V	3.2V

Physical Characteristics			
Dimensions (L x W x H)	112 x 65 x 28 mm	112 x 88.19 x 32 mm	112 x 88.19 x 32 mm
Weight	141g	141g	186g
Sensor Dimensions	D: Ø16mm* L: 27mm,	-	-
Probe Info	-	PT1000 Platinum Thermal	Thermocouple Characteristic
Probe Temperature Detecting Range	-20°C~55°C	-70°C to 200°C	-40°C to 125°C
Probe Wire Length	-	2m	1m
Probe Dimensions	-	5mm in diameter * 150mm in length, needle probe	-
Ingress Protection	IP65	IP65	IP65
Operating Temperature	-20°C to 55°C		
Relative Humidity	<90% RH (non condensing)		
Storage Temperature	-40°C~85°C		
Standards Conformance			
Regulatory Compliance	CE RED, FCC PART 15B	TELEC, CB C TUV US	CE RED, FCC PART 15B

■ LS200 series (2/2)

Product	LS200-RF	LS200-LG	LS200-CM3
Wireless Transmission			
Technology	LoRaWAN		
Frequency	EU868: 863–870 MHz US915: 902–928 MHz		
TX Power	US915 20dbm AS923 16dbm (optional) AU915 20dbm (optional)	EU868 16dbm KR920 14dbm (optional) IN865 20dbm (optional)	
Rx Sensitivity	-136dBm (LoRa, Spreading Factor = 12, Bitrate = 293bps) -121dBm (FSK, Frequency Deviation = 5kHz, Bitrate = 1.2kbps)		
Work Mode	OTAA/ABP Class A		
Data Interfaces			
Power Supply	2 x 3.6V ER14505 AA battery in parallel (Battery not included)		
Operating Voltage	DC 3.1V~3.65V	DC 3.1V~3.65V	DC 3.1V~3.65V
Battery Life Time	5 years (25°C, 15-minute reports, TxPower=20dBm, SF10)		
Standby Current	20uA	17uA	25uA
Wake-up Current (Typical value)	7.11mA	7.5mA	127mA
Low Battery Threshold	3.2V	3.2V	3.2V

Physical Characteristics			
Dimensions (L x W x H)	112 x 65 x 32 mm	112 x 65 x 32 mm	112 x 88.19 x 32 mm
Weight	141g	150g	141g
Sensor Dimensions (L x W x H)	-	-	27.5 x 25 x 42.5 mm
Sensor Weight	-	-	49.6 x 3g
Sensor Measurement Info	Temperature Detecting Range: -40°C~55°C	Illuminance Range: 0.01 LUX to 157K LUX	Current Measurement Range: 100mA to 75A Operating Temperature: -40°C to 85°C
Ingress Protection	IP65	IP65	IP53
Operating Temperature	-40°C~55°C	-20°C to 55°C	
Relative Humidity	<90% RH (non condensing)		
Storage Temperature	-40°C~85°C		
Standards Conformance			
Regulatory Compliance	CE RED, FCC PART 15B	CE RED, FCC PART 15B	CE RED, FCC PART 15B

2. Hardware Introduction

2.1 Physical Descriptions

LS100-PIR	
Appearance	<p>The figure illustrates the physical appearance of the LS100-PIR sensor. It includes a photograph of the device and two line drawings. The photograph shows a white, dome-shaped sensor with a small LED indicator, a function button, and an infrared sensor lens. The line drawings show the sensor from a top-down perspective, highlighting the infrared sensitivity adjustment knob and the snap-fit joint.</p> <p>LED Indicator</p> <p>Function Button</p> <p>Infrared Sensor</p> <p>Infrared Sensitivity Adjustment Knob</p> <p>Snap-fit Joint</p>

LS100-WL	
Appearance	<p>The diagram shows a white rectangular sensor with a black cable. Labels with arrows point to the 'LED Indicator' and 'Function Button' on the top surface, and the 'Water Leak Sensor' on the side.</p>
LS100-DW	
Appearance	<p>The diagram shows a white rectangular sensor with a circular lens. Labels with arrows point to the 'LED Indicator' on top, the 'External Antenna' on the side, and the 'Function Button' on the front. A separate 'Magnet' is shown with an arrow pointing to its position on the front panel.</p>
LS200-TH	
Appearance	<p>The diagram shows a white rectangular sensor with a small protrusion on the side. Labels with arrows point to the 'LED Indicator' and 'Function Button' on the top surface, and the 'Built-in Temperature and Humidity' sensor on the side.</p>

LS200-PT	
Appearance	<p>PT1000 Needle Probe</p> <p>LED Indicator</p> <p>Function Button</p>
LS200-TC	
Appearance	<p>LED Indicator</p> <p>Function Button</p> <p>Thermocouple Sensor</p>
LS200-RF	
Appearance	<p>LED Indicator</p> <p>Function Button</p> <p>Built-in Temperature and Humidity</p>

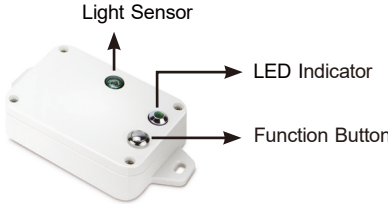
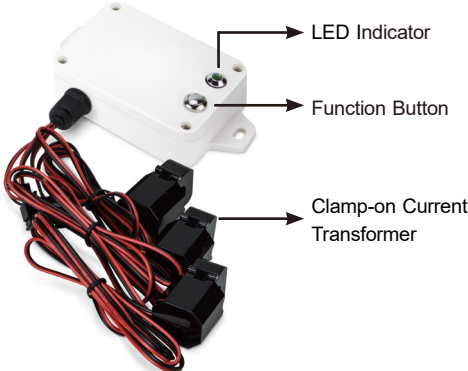
LS200-LG	
Appearance	 <p>Light Sensor</p> <p>LED Indicator</p> <p>Function Button</p>
LS200-CM3	
Appearance	 <p>LED Indicator</p> <p>Function Button</p> <p>Clamp-on Current Transformer</p>

LED Definition:

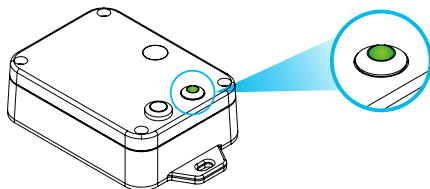

	Color	Function	
LED	Green	Lights 1 time	Indicating the network is successfully connected after turning on LoRaWAN sensor.
		Flashes 1 time	Indicating it is triggered to send a report after pressing the Function Button Once.
		Flashes 3 times	Indicating the LoRaWAN sensor is not in the network after pressing the Function Button Once.
		Flashes 20 times	Indicating it goes to Factory Reset and Restart after long-pressing the Function Button for 5 seconds.

2.2 Hardware Installation

Refer to the illustration and follow the simple steps below to quickly install your **LoRaWAN** Sensor.

2.2.1 Battery Installation

Product uses two CR2450 batteries:

Module: LS100-DW

Unscrew the four screws on the device's cover to remove the front cover. Insert the battery and put back the device's cover and tighten the screws.

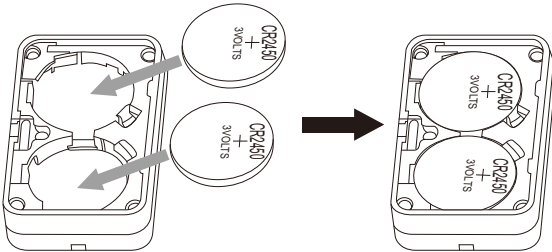

Product uses two ER14505 batteries:

Modules: LS100-PIR, LS100-WL, LS200-TH, LS200-PT, LS200-TC, LS200-RF, LS200-LG, and LS200-CM

Unscrew the four screws on the device's cover to remove the front cover. Insert the battery and put back the device's cover and tighten the screws.

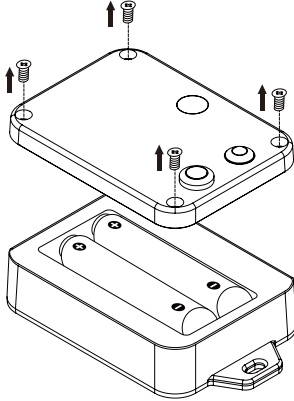

2.2.2 Magnetic Mounting or Wall Mounting

Magnetic mounting

Models: LS100-WL, LS200-TH, LS200-PT, LS200-TC, LS200-RF, LS200-LG, and LS200-CM

The LoRaWAN Sensor features magnetic mounting for easy attachment to the surface with iron material.

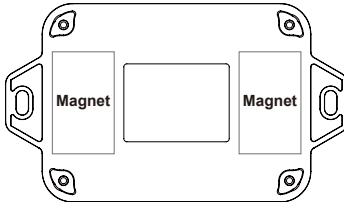

Wall mounting by screws (optional)

Models: LS100-WL, LS200-TH, LS200-PT, LS200-TC, LS200-RF, LS200-LG, and LS200-CM

To make the installation more secure, please use screws (purchased separately) to fix the device on the wall or other objects.

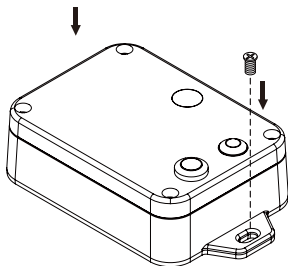

Wall mounting by the double-sided stickers

Model: LS100-PIR

1. Clean the surface of the objects before sticking with the sticker.
2. Tear off the 3M300LSE side of the sticker, place it on the bottom of the product as shown in the picture, and press it.
3. Tear off the other side of the sticker and put the sticker to a clean surface of the wall and press the sticker firmly for around 20 seconds.



Model: LS-100-DW

Tear off the magnetic body's 3M release paper, and then adhere the body to the window or door frame by sticking it in parallel with the magnetic body.

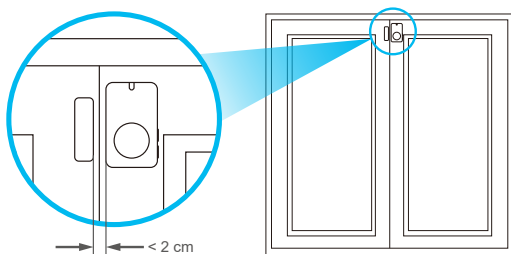

Note

Do not install the device in a metal shielded box or in an environment surrounded by other electrical equipment to avoid affecting the wireless transmission of the device.

2.3.2 Precautions

LS100-WL: IP65 LoRaWAN Water Leak Sensor

The sensor probe of **LS100-WL** has to attach to the smooth ground that may accumulate leakage.

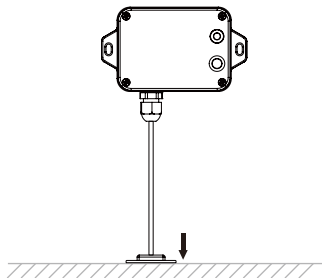

LS100-PIR: IP30 LoRaWAN Indoor Occupancy Sensor

The correct installation of **LS100-PIR** is shown below.

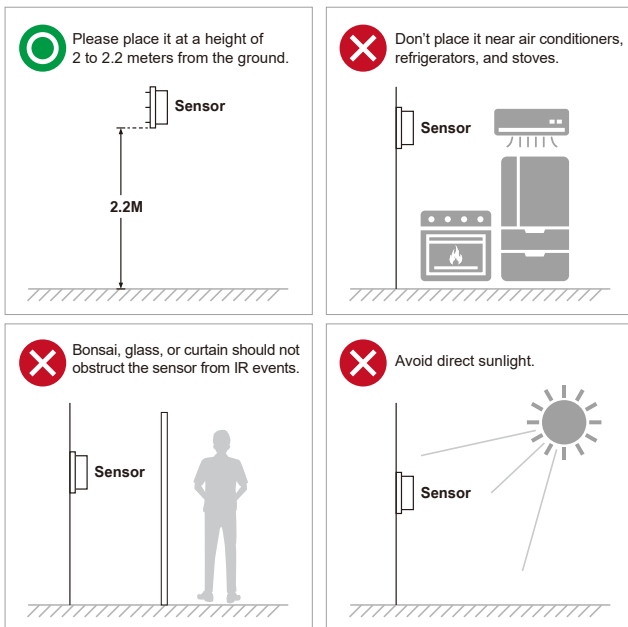

Detection Range

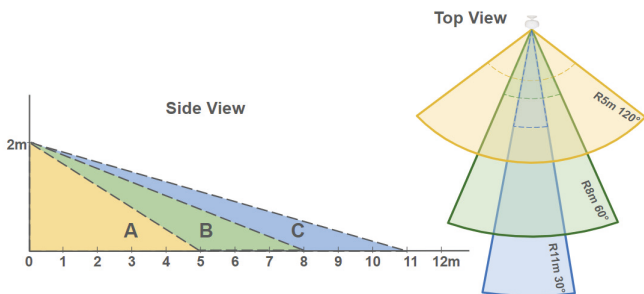

Coverage area A-Distance: 5 meters; sensing angle: 120°

Coverage area B-Distance: 8 meters; sensing angle: 60°

Coverage area C-Distance: 11 meters; sensing angle: 30°

LS100-DW: IP30 LoRaWAN Door and Window Sensor

The distance between the two objects has to be **less than 2cm**.

LS200-TH: IP65 LoRaWAN Indoor Temperature and Humidity Sensor (-20~55 degrees C)

Installation height recommendation: 1-2 m.

LS200-PT: IP65 LoRaWAN Product Temperature Sensor (PT1000 Needle Probe, -70~200 degrees C)

When **LS200-TC** is compared with the last reported values, the temperature change is expected to exceed **0.1°C (by default)**. It will report values at the Min Time interval if it does not exceed 0.1°C (by default). It will report values at the Max. Time interval.

LS200-TC: IP65 LoRaWAN Machine Temperature Sensor (Thermocouple -40~125 degrees C)

When **LS200-TC** is compared with the last reported values, the temperature change is expected to exceed **10°C (by default)**. It will report values at the Min. Time interval. If it does not exceed 10°C (by default), it will report values at the Max. Time interval.

LS200-LG: IP65 LoRaWAN Refrigerator Temperature and Humidity Sensor (-40~55 degrees C)

Compare the illumination value detected by the illumination sensor with the set illumination value. The detected value exceeds the set value (**default 50 Lux**), the currently detected illumination value is sent.

LS200-CM3

The 3-phase current meter (**LS200-CM3**) samples the current according to Min. Time. If the current value sampled this time relatively exceeds the set value (**the default is 100mA**) more than the current value reported last time, the device will immediately report the current value sampled this time. If the current variation does not exceed the default value, the data will be reported regularly according to Max. Time.

1. When using it, the back of it can be adsorbed on the iron surface, or the two ends can be fixed to the wall with screws.
2. When installing the LS200-CM3 current transformer, please separate the live and neutral wires of the wire to be detected, and only take the live wire through current transformer and start the measurement according to the wiring below:

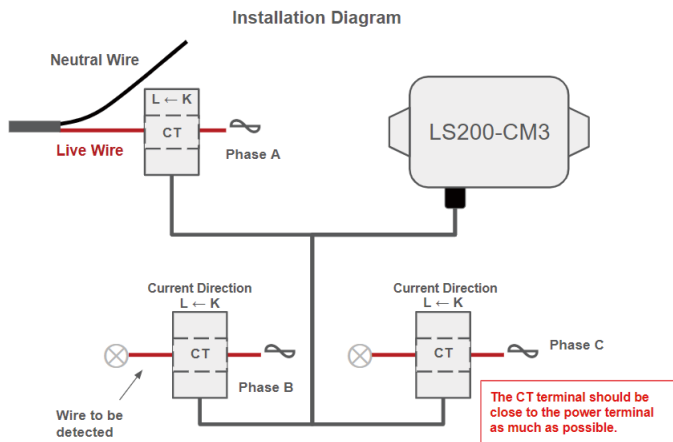

If the live wire and the neutral wire are connected together at the same time, they will offset each other and the measurement is 0.

"L ← K" is marked on the bottom of the CT.

WARNING 1: Before using, user must check whether the appearance is deformed; otherwise, the test accuracy will be affected.

WARNING 2: The operating environment should be kept away from strong magnetic fields, so as not to affect the test accuracy. It is strictly forbidden to use in humid and corrosive gas environments.

WARNING 3: Before installation, please confirm the current value of the load. If the current value of the load is higher than the measurement range, select a model with a higher measurement range.

WARNING 4: Children and the persons who do not have enough knowledge about electric measurements must not use this instrument.

WARNING 5: Do not measure the electricity naked or barefooted to protect yourself from electrical shock hazard.

WARNING 6: Be careful not to get hurt with the sharp test lead pins.

WARNING 7: Warning for High Power Line Measurements

High Power Line (High Energy Circuits) such as Distribution Transformers, Bus Bars and Large Motors are very dangerous. High Power Line sometimes includes High Surge Voltage that could cause explosive short in the instrument and could result in shock hazard. For voltage measurement of High Power Line, do not touch Clamp Meter, its Test Leads, and any part of the circuit.

WARNING 8: Warning for High Voltage Measurements

Even for Low Energy Circuits of electric/electronic appliances, such as heating elements, small motors, line cords and plugs, High Voltage Measurements are very dangerous. Do not touch Clamp Meter, Test Leads, and any part of the circuit. Generally, shock hazard could occur when the current between the circuit that involves more than 33V rms or 46.7V DC or peak and ground goes up to 0.5mA or more.

3. Preparation

Before accessing the LoRaWAN Sensor controllers, user has to install utility tool for operation.

3.1 Requirements

PLANET Industrial **LoRaWAN Gateway**, e.g., **LCG-300 series**

Workstations running Windows OS, MAC OS X or later, Linux, UNIX, or other platforms are compatible with TCP/IP protocols and installed with web browser.



Note

It is recommended to use Chrome 98.0.xxx or above to access the LoRaWAN Gateway. If the Web interface of the LoRaWAN Gateway is not accessible, please turn off the anti-virus software or firewall and then try it again.

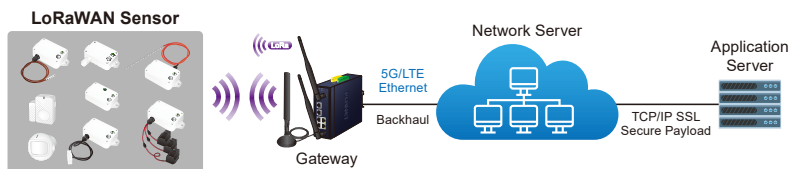

3.2 LoRaWAN Gateway Setup

3.2.1 LoRa Frequency Setting

- Open browser and login to the Web GUI of LCG-300 series.
- Click **LoRa** label on main menu and **LoRa** label on function menu.

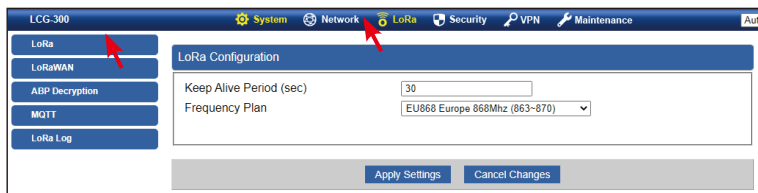

- c. Select the **Frequency Plan** for your local area. Some Frequency Plan supports **Frequency Sub Band**. (In this test case, select "US915" for frequency plan and "US915, FSB2" for frequency sub band.)

LCG-300
series-US

Frequency Plan	US915 United States 915Mhz (902~928) AU915 Australia 915Mhz (915~928) US915 United States 915Mhz (902~928) KR920 Korea 920MHz (920~923) AS923 Asia (920~923,Default:923.2/923.4) AS923-1 AS923 Asia (923~925,Default:923.2/923.4) AS923-1 AS923 Asia (Default:921.4/921.6) AS923-2 AS923 Asia (Default:916.6/916.8) AS923-3
----------------	---

Frequency Sub Band	2: US915 , FSB2 (903.9~905.3) 1: US915 , FSB1 (902.3~903.7) 2: US915 , FSB2 (903.9~905.3) 3: US915 , FSB3 (905.5~906.9) 4: US915 , FSB4 (907.1~908.5) 5: US915 , FSB5 (908.7~910.1) 6: US915 , FSB6 (910.3~911.7) 7: US915 , FSB7 (911.9~913.3) 8: US915 , FSB8 (913.5~914.9)
--------------------	--

LCG-300
series-EU

Frequency Plan	EU868 Europe 868Mhz (863~870) EU868 Europe 868Mhz (863~870) IN865 India 865MHz (865~867) RU864 Russia 864MHz (864~870) MA869 Morocco 869(869.1~870.3)MHz
----------------	---

3.2.2 LoRaWAN Setting

Click **LoRaWAN** label and input the related data.

LoRa LoRaWAN ABP Decryption MQTT LoRa Log	LoRa Configuration LoRaWAN Server Mode: LoRaWAN UDP Email: <input type="text"/> Gateway ID: <input type="text"/> Server Provider: The Things of Network V3 Server Address: eu1.cloud.thethings.network Uplink Port: 1700 Downlink Port: 1700 Apply Settings Cancel Changes
--	--

Object	Description
LoRaWAN Server Mode	The service of LoRaWAN
Email	The registered email of LoRaWAN server
Gateway ID	The unique identity of the base station, which the server can distinguish a different LoRaWAN base station
Server Provider	The service provider of LoRaWAN server
Server Address	The IP address of LoRaWAN server
Uplink Port	LoRaWAN data service center program uplink port. Value range is 0-65535 and the default value is 1700.
Downlink Port	LoRaWAN data service center program downlink port. Value range is 0-65535 and the default value is 1700.

3.2.3 Setting Up of LoRa Connection via ABP Decryption

- Click Enable.
- Click **Add ABP Key** Button. Then input data which has to be the same as the settings of LoRa node/sensor.

Object	Description
Device Address*	The DevAddr of device
Network Session Key*	The NWKSKEY of device
Application Session Key*	The APPSKEY of device
Decoder	The decoder way
Downlink Frame Counter	The action status of sensor or node

***The data of the LoRa sensor has to be provided by provider; and user also can change the setting after connecting.**

When sensor connects to LoRa Gateway, the RSSI and SNR would be shown on the UI of gateway as seen below.

ABP Decryption							
ABP Decryption <input checked="" type="radio"/> Enable <input type="radio"/> Disable							
ABP Keys							
No.	Device Address	Network Session Key	Application Session Key	Decoder	RSSI(dBm)	SNR(dB)	Action
1	0004247B	FEB44858F85903B441DCFE2589E395DE	C98FC8ECC87F6669304A885A38651E2DE	ASCII_String			
2	0004247D	ZDB81FF308FD044A209C485040090888	09080608046FC640E12035321807C894E	ASCII_String	-88	11	
3	00042483	ACF090F0059C480C3378123570E93EB23	ED8E64ED063A66863223489F67E961F4	ASCII_String			
4	00042482	2521337C34E480D0F1D0E30803D0E4D13	BC809E3E35248FE4186813EC0C4CE588	ASCII_String			
5	00042484	F87E909D970D082531831B330320A187	A6080C2C24800E194E75763C F06E80C8	ASCII_String			
6	0004247E	CC153C4AAA36059E8E21E94084C5FA776	87F8C523813ABA789365040C7AB18CD6	ASCII_String			
7	0004247F	639F8C2732082348D92A703421C1F87	445628E34F668C3862089C26E09E87E1	ASCII_String	-75	12	
8	0004247C	30780E7F2873C803DC F9848F73050E8	E29E142F8A3512804C465873C85862A	ASCII_String			
9	0004247A	38775BA3F4543A2885985845947C8155	6CFA064F25868E3E32C408E88C46B5FA	ASCII_String			
10	00042480	F187CF6CD08A1458C8C80FF7404892389	5C1E945F79C0F06894E0CEE37D9748A	ASCII_String	-94	8	

4. Customer Support

Thank you for purchasing PLANET products. You can browse our online FAQ resource and User's Manual on PLANET Web site first to check if it could solve your issue. If you need more support information, please contact PLANET switch support team.

PLANET online FAQs:

<https://www.planet.com.tw/en/support/faq>

Switch support team mail address:

support@planet.com.tw

Copyright © PLANET Technology Corp. 2023.

Contents are subject to revision without prior notice.