



# **H.264 Mega-Pixel 20M IR Vandal Proof Dome IP Camera**

## **ICA-HM135**

### **User's Manual**

Version: 1.01

Date: October. 2009

## **Copyright**

Copyright © 2009 by PLANET Technology Corp. All rights reserved. No part of this publication may be reproduced, transmitted, transcribed, stored in a retrieval system, or translated into any language or computer language, in any form or by any means, electronic, mechanical, magnetic, optical, chemical, manual or otherwise, without the prior written permission of PLANET.

PLANET makes no representations or warranties, either expressed or implied, with respect to the contents hereof and specifically disclaims any warranties, merchantability or fitness for any particular purpose. Any software described in this manual is sold or licensed "as is". Should the programs prove defective following their purchase, the buyer (and not PLANET, its distributor, or its dealer) assumes the entire cost of all necessary servicing, repair, and any incidental or consequential damages resulting from any defect in the software. Further, PLANET reserves the right to revise this publication and to make changes from time to time in the contents hereof without obligation to notify any person of such revision or changes.

All brand and product names mentioned in this manual are trademarks and/or registered trademarks of their respective holders.

## **Federal Communication Commission Interference Statement**

This equipment has been tested and found to comply with the limits for a Class B digital device, pursuant to Part 15 of FCC Rules. These limits are designed to provide reasonable protection against harmful interference in a residential installation. This equipment generates, uses, and can radiate radio frequency energy and, if not installed and used in accordance with the instructions, may cause harmful interference to radio communications. However, there is no guarantee that interference will not occur in a particular installation. If this equipment does cause harmful interference to radio or television reception, which can be determined by turning the equipment off and on, the user is encouraged to try to correct the interference by one or more of the following measures:

1. Reorient or relocate the receiving antenna.
2. Increase the separation between the equipment and receiver.
3. Connect the equipment into an outlet on a circuit different from that to which the receiver is connected.
4. Consult the dealer or an experienced radio technician for help.

## **FCC Caution**

To assure continued compliance. (example-use only shielded interface cables when connecting to computer or peripheral devices). Any changes or modifications not expressly approved by the party responsible for compliance could void the user's authority to operate the equipment.

This device complies with Part 15 of the FCC Rules. Operation is subject to the Following two conditions: ( 1 ) This device may not cause harmful interference, and ( 2 ) this Device must accept any interference received, including interference that may cause undesired operation.

## **Federal Communication Commission (FCC) Radiation Exposure Statement**

This equipment complies with FCC radiation exposure set forth for an uncontrolled environment. In order to avoid the possibility of exceeding the FCC radio frequency exposure limits, human proximity to the antenna shall not be less than 20 cm (8 inches) during normal operation.

## **Safety**

This equipment is designed with the utmost care for the safety of those who install and use it. However, special attention must be paid to the dangers of electric shock and static electricity when working with electrical equipment. All guidelines of this and of the computer manufacture must therefore be allowed at all times to ensure the safe use of the equipment.

## **CE Mark Warning**

This is a Class B product. In a domestic environment, this product may cause radio interference, in which case the user may be required to take adequate measures.

## **WEEE Regulation**



To avoid the potential effects on the environment and human health as a result of the presence of hazardous substances in electrical and electronic equipment, end users of electrical and electronic equipment should understand the meaning of the crossed-out wheeled bin symbol. Do not dispose of WEEE as unsorted municipal waste and have to collect such WEEE separately.

## **Revision**

User's Manual for PLANET H.264 Mega-Pixel 20M IR Vandal Proof Dome IP Camera  
Model: ICA-HM135  
Rev: 1.01 (October. 2009)  
Part No. EM-ICAHM135

# Table of Content

1.	Introduction.....	6
1.1	Overview.....	6
1.2	Features.....	6
1.3	Package Contents.....	7
2.	Basic Setup.....	8
2.1	System Requirements.....	8
2.2	Physical Description.....	9
2.2.1	Identification of ICA-HM135 cable.....	9
2.3	Hardware Installation.....	11
2.3.1	Physical Installation.....	11
2.4	Initial Utility Installation.....	12
2.5	Preparation.....	14
2.5.1	Search and View by PLANET IPWizard II.....	14
	Search.....	14
	View.....	15
2.5.2	Configure Network by PLANET IPWizard II.....	15
2.6	Using UPnP of Windows XP or Vista.....	17
2.6.1	Windows XP.....	17
2.6.2	Windows Vista.....	22
2.7	Install the Device behind a NAT Router.....	23
2.8	Setup ActiveX to use the Internet Camera.....	24
2.8.1	Internet Explorer 6 for Windows XP.....	24
2.8.2	Internet Explorer 7 for Windows XP.....	25
2.8.3	Internet Explorer 7 for Windows Vista.....	26
3.	Web-based Management.....	27
3.1	Introduction.....	27
3.2	Connecting to Internet Camera.....	27
3.3	Live View.....	29
3.4	ActiveX Control.....	32
3.4.1	Digital Zoom.....	33
3.4.2	Record.....	33
3.4.3	Snapshot.....	34
3.4.4	Voice.....	34
3.4.5	Statistics.....	35
3.4.6	About.....	35
3.5	Network Configuration.....	36
3.5.1	Network.....	36
3.5.2	DDNS server.....	38
3.5.3	PPPoE.....	39
3.5.4	Streaming.....	40
3.5.5	UPnP.....	42
3.5.6	IP Filter.....	43
3.5.7	IP Notification.....	44
3.6	Camera Configuration.....	46
3.6.1	Picture.....	46

3.6.2 PTZ Setting .....	48
3.6.3 Preset Setting .....	49
3.6.4 Tour Setting .....	49
3.7 System.....	51
3.7.1 System.....	51
3.7.2 Date & Time.....	52
3.7.3 Maintenance.....	53
3.8 Video.....	55
3.8.1 Common .....	55
3.8.2 H264 Profile.....	56
3.8.3 MPEG4 Profile .....	57
3.8.4 MJPEG Profile .....	58
3.9 Audio Configuration.....	59
3.10 User Privilege Access Configuration .....	60
3.11 E-Mail Configuration.....	61
3.12 Object Detection .....	62
3.13 Event Server Configuration.....	63
3.13.1 FTP Server .....	63
3.13.2 TCP Server.....	64
3.13.3 HTTP Server .....	65
3.13.4 SAMBA Server.....	66
3.14 Event Schedule Configuration.....	67
3.15 Record Configuration.....	71
Appendix A: Alarm I/O Connector.....	72
Appendix B: PING IP Address.....	74
Appendix C: 3GPP Access .....	75
Appendix D: Bandwidth and Video Size Estimation .....	76
Appendix E: DDNS Application .....	77
Appendix F: Configure Port Forwarding Manually .....	82
Appendix G: Troubleshooting & Frequently Asked Questions .....	85
Appendix H: Product Specification .....	90

# 1. Introduction

Thank you for purchasing the H.264 Mega-Pixel 20M IR Vandal Proof Dome IP Camera. It is versatile and high image solution of surveillance application for day and night. The ICA-HM135 is designed with vandal-proof and IP66 weather-proof case. It can provide the best solution for both of indoor and outdoor installation. The vandal-proof designs with die-cast aluminum body that can prevent the artificial destroy. Water-resistant construction with weather-proof solid housing that use the Aluminum rugged and all-weather waterproof enclosure maintains the reliable operation in any environment.

The PLANET Internet camera support Multi-Profile function can stands for simultaneously video streams. These Network Cameras can generate H.264, MPEG-4 and M-JPEG streaming simultaneously to different clients. Moreover, the resolution can be different from one client to another. This state-of-art design is considerable to fit in various network environments. The PLANET ICA-HM130 is a 1.3 Mega-pixel CMOS image sensor Dome Internet Camera which uses high resolution of SXGA (1280 x 1024 pixels) for capturing color images.

Compliant with IEEE 802.3af PoE (Power over Ethernet), the ICA-HM130 offers the benefit of easy deployment for users to install the cameras without concerning the power outlet location.

## 1.1 Overview

This user's guide explains how to operate this camera from a computer. User should read this manual completely and carefully before you operate the device

## 1.2 Features

- Clear and high resolution pictures for day and night with High quality of 1.3 Mega-Pixel CMOS image sensor
- 4 times brighter than ordinary IR LED and has visible distance up to 20 meter
- 3GPP for 3G mobile remote applications
- Multi-profile encoder supports H.264, MPEG-4 and M-JPEG video compression simultaneously
- Easy configuration and manage via Windows-based utility or web browser
- DDNS, PPPoE and FTP uploading supports more alternatives in surveillance network
- Motion Detection feature can motion detection feature can monitor any suspicious movement in specific area
- 2-way audio supported when adding external speaker and microphone
- With IR-cut filter can get better video quality in the day / night
- IP-66 protection for outdoor using
- Compliant with IEEE 802.3af PoE interface

## 1.3 Package Contents

User can find the following items in the package:

Internet Camera x 1

Power Adapter x 1

Mount Screws x 4

L-Wrench x 1

User's Manual CD x 1

Quick Installation Guide x 1

- 
- NOTE:**
1. If any of the above items are missing, please contact your dealer immediately.
  2. Using the power supply that is not the one included in Internet camera packet will cause damage and void the warranty for this product.
-

## 2. Basic Setup

This chapter provides details of installing and configuring the internet camera

### 2.1 System Requirements

Network Interface	10/100MBase-TX Ethernet
Monitoring System	Recommended for Internet Explorer 6.0 or later
System Hardware	<ul style="list-style-type: none"><li>· CPU: Pentium 4, 3.0GHz or above</li><li>· Memory Size : 512 MB (512 MB or above Recommended )</li><li>· VGA card resolution : 1024 x 768 or above</li><li>· VGA card memory : 64 MB or above (at least 128 MB for Megs-pixel resolution)</li><li>· <b>Network bandwidth: In VGA resolution mode, minimum upload bandwidth is 1Mbps.</b></li></ul>

**NOTE:** The listed information is minimum system requirements only. Actual requirement will vary depending on the nature of your environment.

## 2.2 Physical Description

### 2.2.1 Identification of ICA-HM135 cable

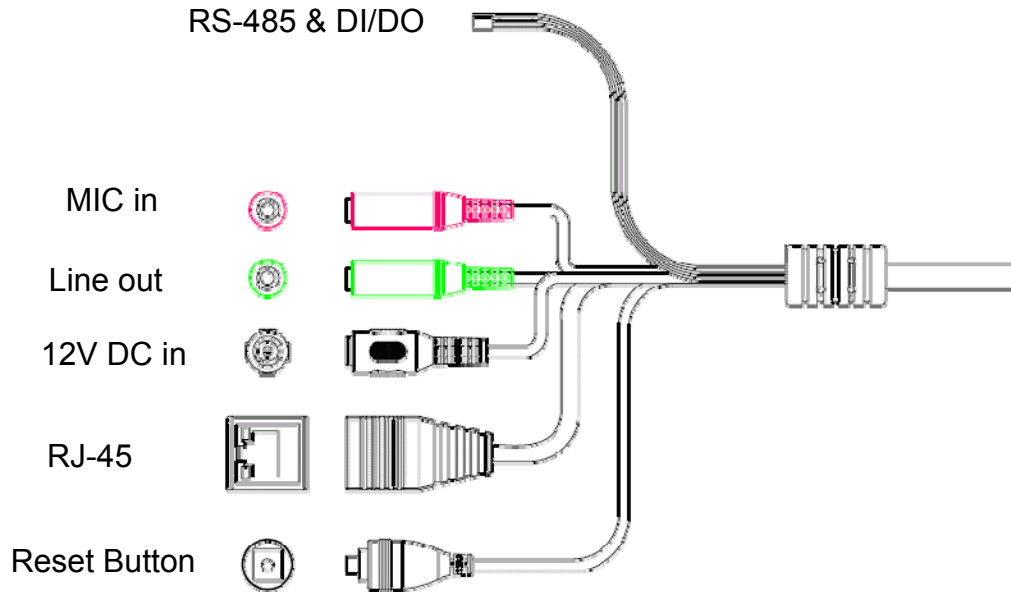

Connect RS-485 to external scanner and connect to sensor in and alarm out devices.

RS-485 & DIDO	Name	Cable Color	Function
	12VDC	Brown/White	DC 12V (50mA maximum)
	GND	Blue/White	GND
	D+	Purple/White	RS-485 data +
	D-	Gray	RS-485 data -
	DI	Green/White	Digital signal input
	DO	Orange/White	Digital signal output

**NOTE:** The RS-485 of internet camera is master that can control external scanner.

**MIC in**  
(audio in) Connect a microphone to the network camera.

**Line out**  
(audio out) Connect a loud speaker to the network camera. This function is for voice alerting and two-way audio.

**DC-in Jack** The input power is 12VDC.  
**Note:** ONLY use package power adapter supplied with the internet. Otherwise, the product may be damaged.

Connects to 10Base-T Ethernet or 100Base-TX Fast Ethernet cabling. This Ethernet port built N-Way protocol can detect or negotiate the transmission speed of the network automatically. Please use Category 5 cable to connect the Network Camera to a 100Mbps Fast Ethernet network switch or hub.

In the LAN socket, there are two LED embedded:

**RJ-45**

**LAN LED (green color)**

This LED will be flashing while network accessing via Ethernet.

**Power LED (orange color)**

This LED is used to indicate whether DC power is on or not. In addition, this LED will be flashing while the wireless accessing of the Camera.

This button is used to restore the all factory default settings. Sometimes restarting the device will make the system back to a normal state. However, if the system still got problems after restart, user can restore the factory default settings and install it again.

**Restore the device:**

**Reset Button**

- a.) Press the button down continuously.
- b.) Hold the button at least 5 seconds and release it. Then the device has been restored to default settings and reboot again.

**Note:** Restoring the factory default setting will lose the all previous settings included IP address forever. User needs to run the PLANET IPWizard II program to search the device and configure it to let the device work properly again.

## 2.3 Hardware Installation

### 2.3.1 Physical Installation

1. Fix Internet camera to desired location with mount fixture
2. Connect RS-485 D+ and D- (if you need to control PT scanner)
3. Connect an Ethernet cable

Connect the LAN cable on the camera to the network device (hub or switch).

---

**NOTE:** If there has an IEEE802.3af PoE switch in your network, you can connect the camera LAN cable to this PoE switch to obtain power. The power adapter is unnecessary when internet camera is connected to a PoE switch.

---

#### 4. Check the LAN LED

The LED is defined to identify LAN connection type. When LAN port is connected, the LED will be green.

#### 5. Attach the power supply

Plug in power adapter and connect to power source. After power on, the camera will start to operate.

---

- NOTE:**
1. Only use the power adapter supplied with internet camera. Otherwise, the product may be damaged.
  2. The power adapter is unnecessary when internet camera is connected to a PoE switch. Otherwise, the product may be damaged when internet camera is connected to a PoE switch and power adapter simultaneously.
- 

#### 6. Attach BNC connector (option)

Connect the video BNC connector to a monitor set if necessary check camera viewing angle and focus.

#### 5 Attach Speaker to camera (option)

If user needs not only video stream but also audio stream, then the speaker should be attached to camera.

## 2.4 Initial Utility Installation

This chapter shows how to quick set up your H.264 camera. The camera is with the default settings. However to help you find the networked camera quickly the windows utility PLANET IPWizard II can search the cameras in the network that shall help you to configure some basic setting before you started advanced management and monitoring.

1. Insert the bundled CD into the CD-ROM drive to launch the auto-run program. Once completed, a welcome menu screen will appear.
2. Click the “IPWizard II” hyperlink; you will see the dialog box as below.

---

**NOTE:** If the welcome screen does not appear, click “Start” at the taskbar. Then, select “Run” and type “D:\Utility\IPWizard II\setup.exe”, assume D is your CD-ROM drive.

---

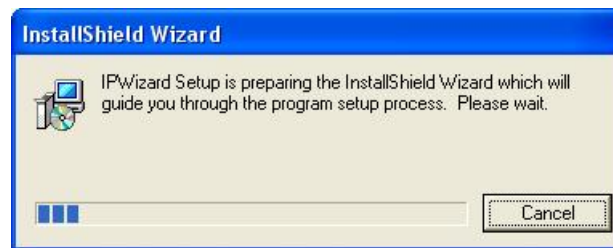

3. The “Welcome to the InstallShield Wizard for PLANET IPWizard II” prompt will display on the screen and click “**Next**” to continue.



4. Please click “**Next**” to install with original settings, or you may click “**Change...**” button to modify the install folder then press “Next” to continue.

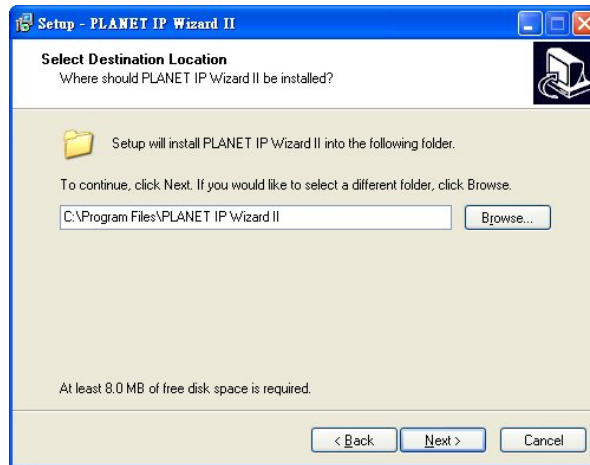

5. Please click **“Install”** to start the installation.

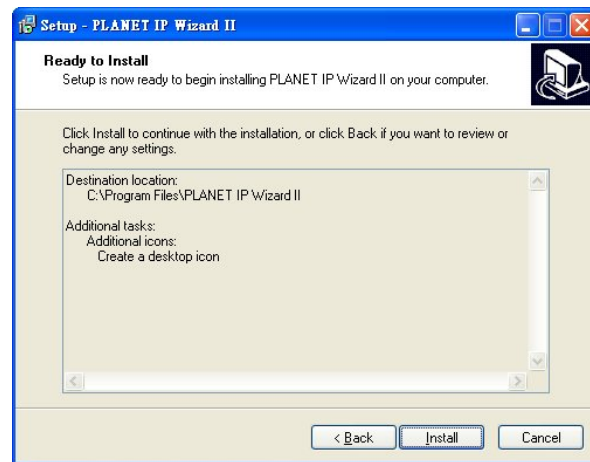

6. Please click **“Finish”** to complete the installation and launch program immediately.



## 2.5 Preparation

When you installed the camera on a LAN environment, you may execute PLANET IPWizard II to discover camera's IP address and set up related parameters in the camera.

### 2.5.1 Search and View by PLANET IPWizard II

When you installed the Camera on a LAN environment, you have two easy ways to search your Cameras by PLANET IPWizard II or UPnP discovery. Here is the way to execute PLANET IPWizard II to discover Camera's IP address and set up related parameter in a Camera.

#### Search

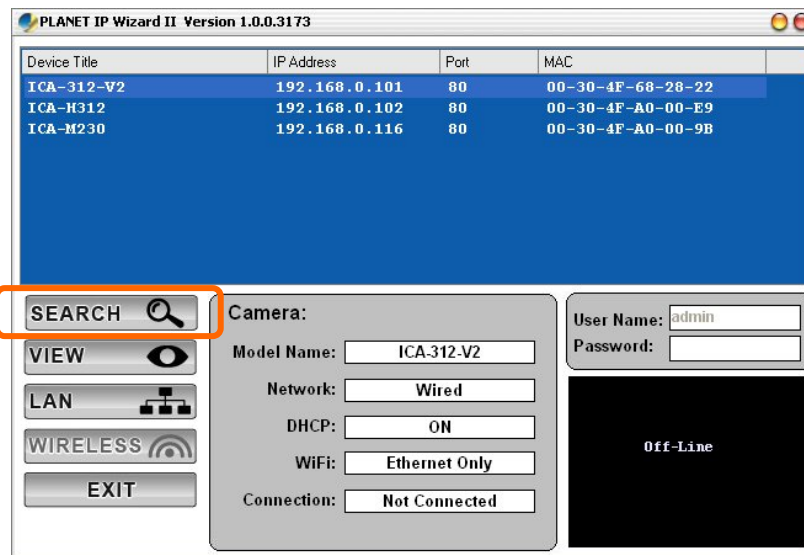

When launch the PLANET IPWizard II, a searching window will pop up. PLANET IPWizard II is starting to search Network Cameras on the LAN. The existed devices will be listed as below.

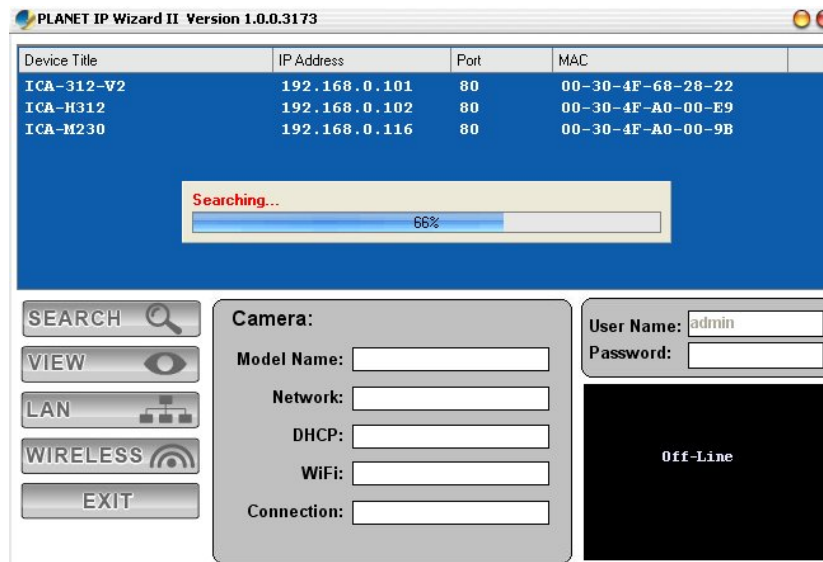

## View

If PLANET IPWizard II finds network devices, **View** button will be available. Please select the device you want to view and click the **View** button. Then you could see the video from camera directly. Furthermore you could double click the left button of mouse to link to the network device by browser.

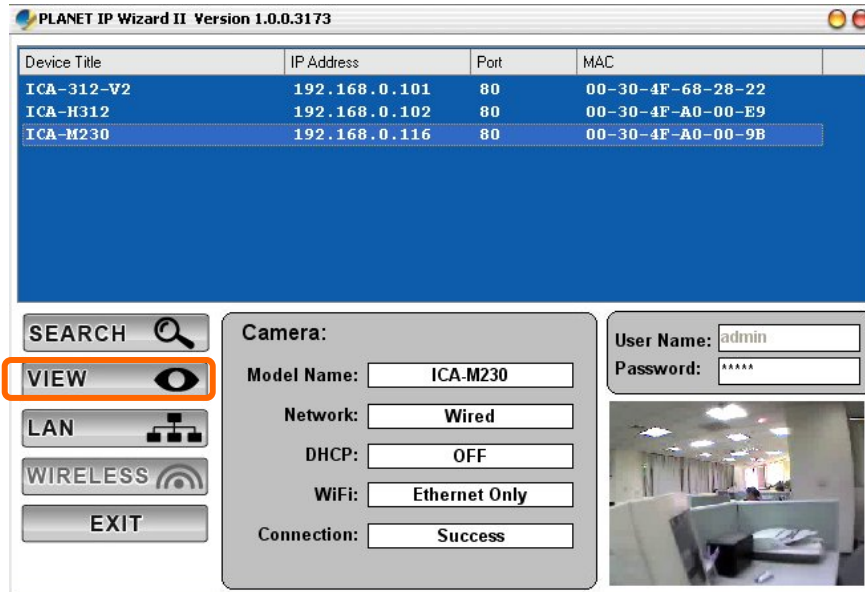

## 2.5.2 Configure Network by PLANET IPWizard II

In case you want to change the IP related parameters of wired interface, please select the device you want to configure and click the **LAN** button. Relative settings will be carried out as below.

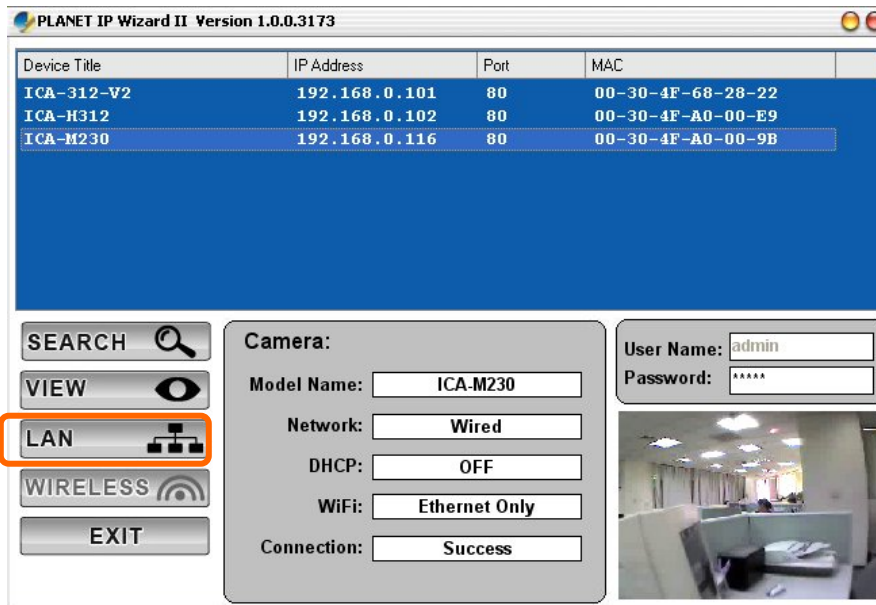

You could modify the relative settings of the selected device. Click “<<” button will quit the LAN setting procedure and click “>>” button will move to next page as below.

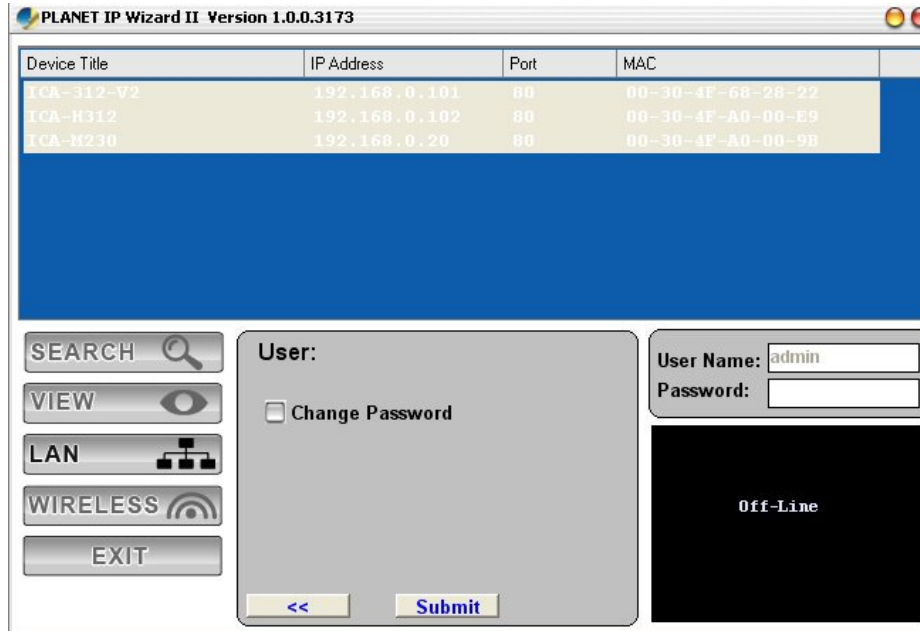

In case, you do not want to change username and/or password, then just click “Submit” button to perform your setting accordingly. Click “<<” button will go back to previous page. If you like to change username and/or password of the device, just click the check button. Then, the related fields will show up as below.

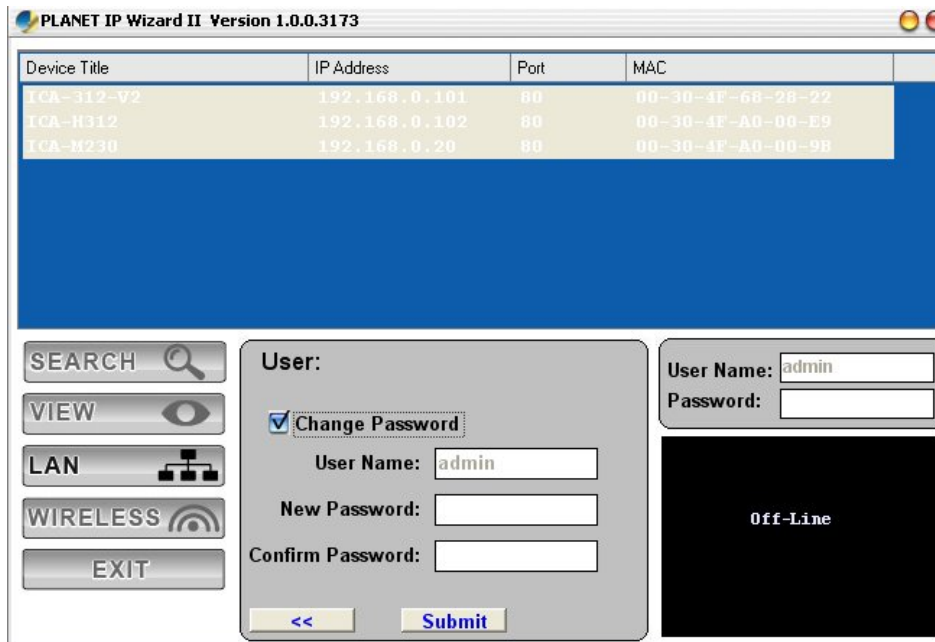

After keying in new username and password, click “Submit” button to perform your setting accordingly. Click “<<” button will go back to previous page.

## 2.6 Using UPnP of Windows XP or Vista

### 2.6.1 Windows XP

UPnP™ is short for Universal Plug and Play, which is a networking architecture that provides compatibility among networking equipment, software, and peripherals. This device is an UPnP enabled device. If the operating system, Windows XP, of your PC is UPnP enabled, the device will be very easy to configure. Use the following steps to enable UPnP settings only if your operating system of PC is running Windows XP.

---

**NOTE:** Windows 2000 does not support UPnP feature.

---

Go to **Start > Settings**, and Click **Control Panel**

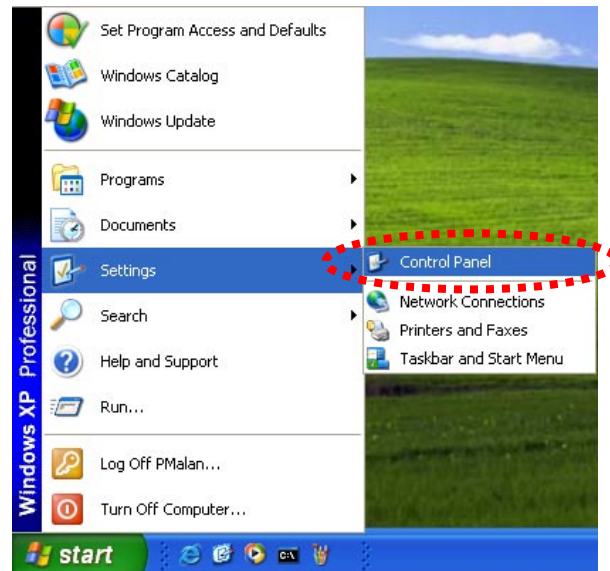

The **“Control Panel”** will display on the screen and double click **“Add or Remove Programs”** to continue

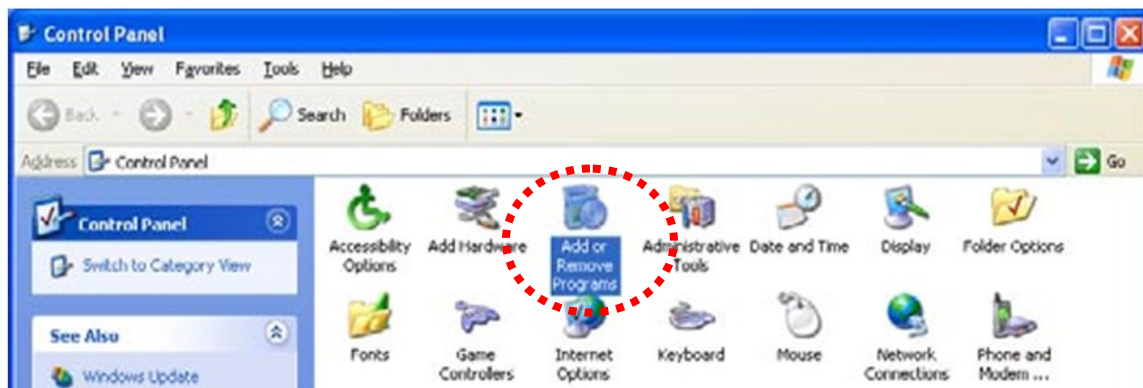

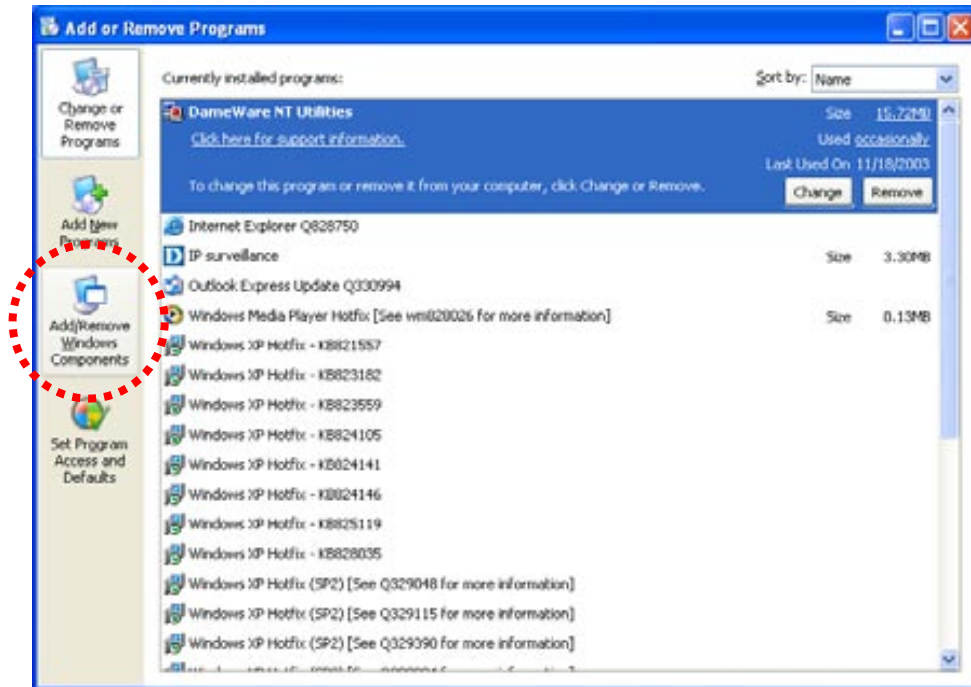

The following screen will appear, select **“Networking Services”** and click **“Details”** to continue

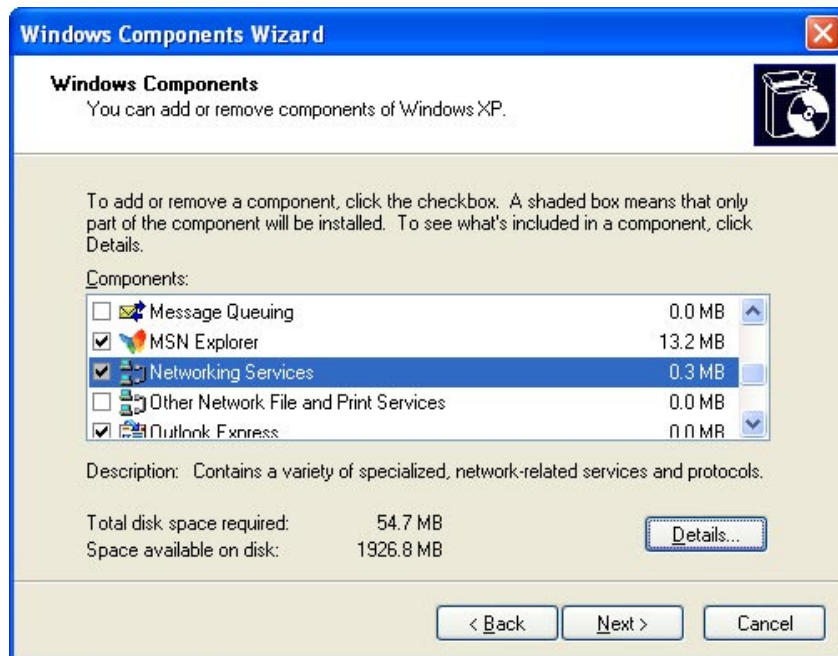

The “Networking Services” will display on the screen, select “**Universal Plug and Play**” and click “**OK**” to continue.

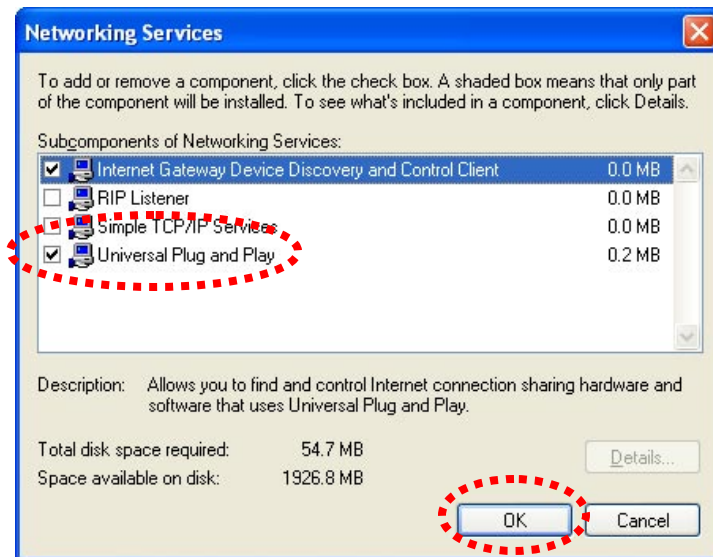

Please click “**Next**” to continue

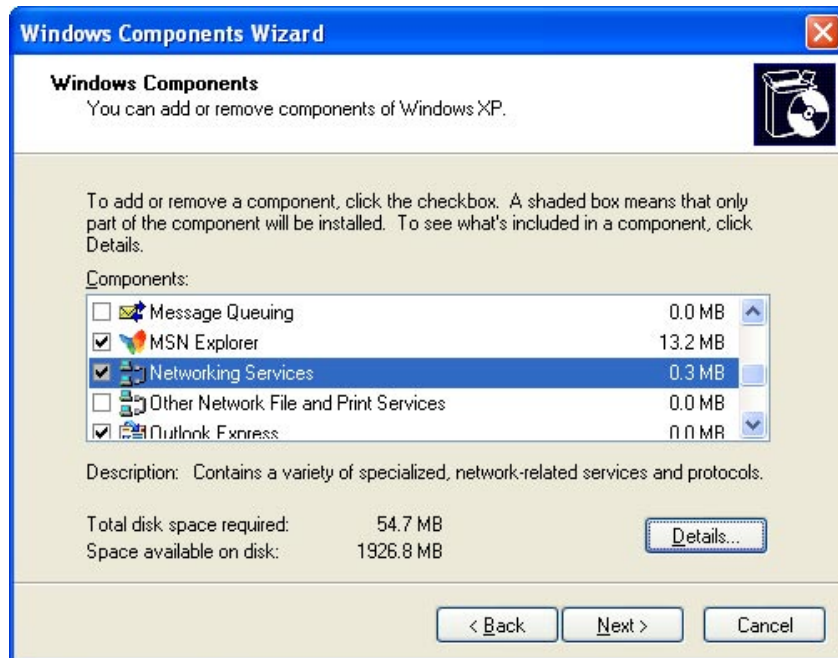

The program will start installing the UPnP automatically. You will see the below pop-up screen, please wait while Setup configures the components.

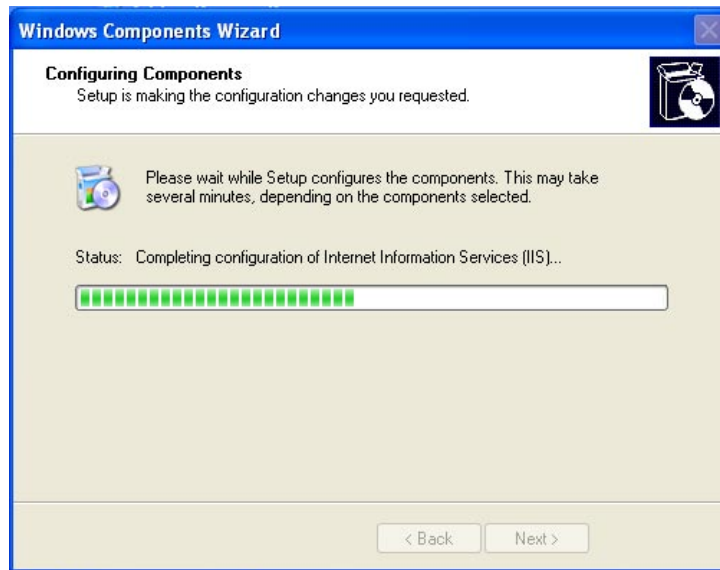

Please click **Finish** to complete the UPnP installation



Double-click **“My Network Places”** on the desktop, the **“My Network Places”** will display on the screen and double-click the UPnP icon with Internet camera to view your device in an internet browser.

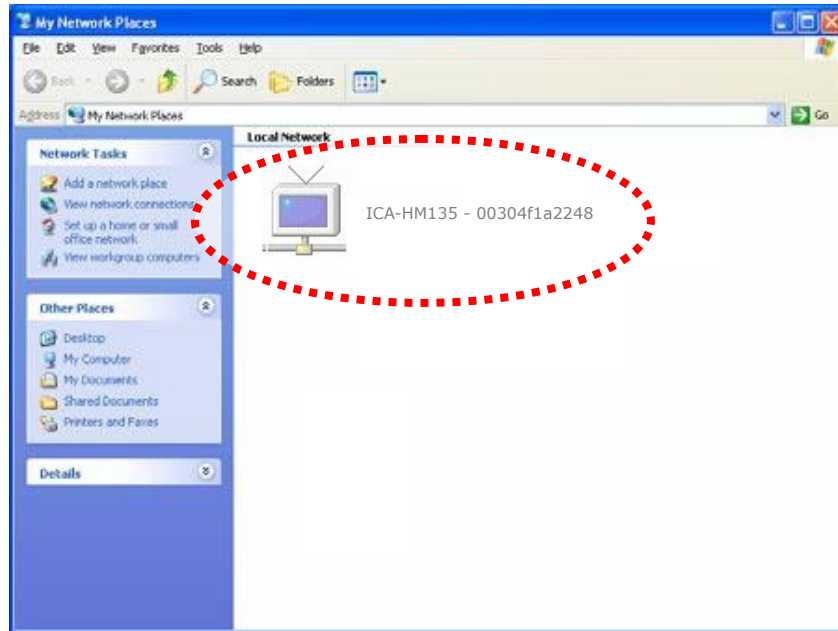

## 2.6.2 Windows Vista

UPnP™ is short for Universal Plug and Play, which is a networking architecture that provides compatibility among networking equipment, software, and peripherals. This device is an UPnP enabled device. If the operating system, Windows Vista, of your PC is UPnP enabled, the device will be very easy to configure. Use the following steps to enable UPnP settings only if your operating system of PC is running Windows Vista.

Go to **Start > Control Panel > Network and Internet > Network and Sharing Center**, and turn on **“Network Discovery”**.

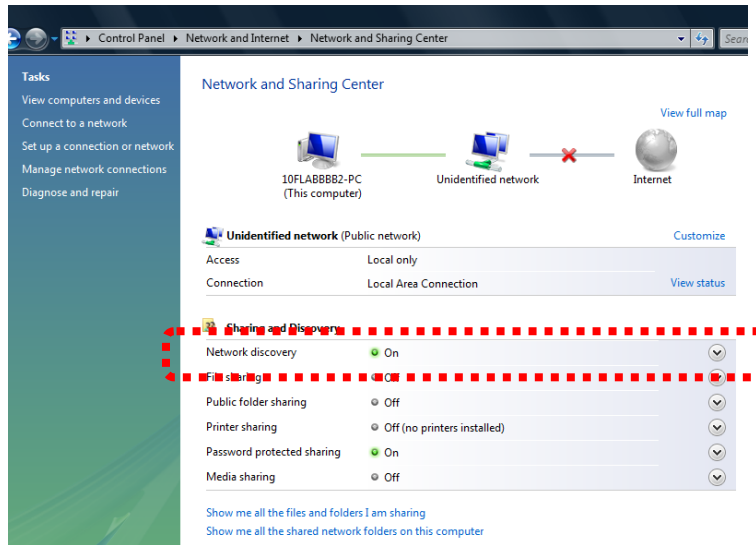

Double-click **“My Network Places”** on the desktop, the **“My Network Places”** will display on the screen and double-click the UPnP icon with Internet camera to view your device in an internet browser.

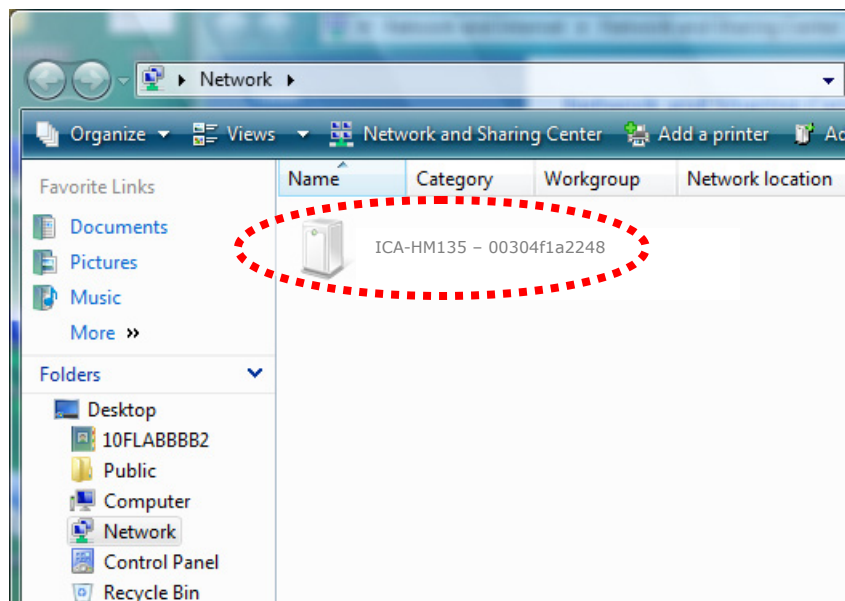

## 2.7 Install the Device behind a NAT Router

Once installed, the device is accessible on your LAN. To access the device from the Internet you must configure your broadband router to allow incoming data traffic to the device. If the device is installed on the LAN with a router, then it may get a dynamic IP address from the DHCP server. However, if the device wants to be accessed from the WAN, its IP address needs to be setup as fixed IP, also the port forwarding or Virtual Server function of router needs to be setup.

However, if your NAT router supports UPnP feature, it can be very easy to achieve NAT traversal automatically. To do this, enable the NAT-traversal feature, which will attempt to automatically configure the router to allow access to the camera.

Installing the device with an UPnP router on your network is an easy 3–step procedure:

- (1) Enable UPnP option of your NAT router
- (2) Enable UPnP NAT traversal option of the Network Camera (default)
- (3) Access your Network Camera by DIPS

### **(1) Enable UPnP option of your NAT router**

To use UPnP IGD function (NAT traversal), you need to make sure the UPnP function is enabled in your router. Most new home routers should support this function. Some of routers are default enable and others are not. Please check user's manual of your NAT router for detail.

### **(2) Enable UPnP NAT traversal option of the Network Camera**

Refer to **Setting → Network → UPnP** page for detail NAT traversal setting. Note that this option is default enabled.

### **(3) Access your Network Camera by DIPS**

Refer to **Setting → System → System** page for detail DIPS information

## 2.8 Setup ActiveX to use the Internet Camera

The Internet camera web pages communicate with the Internet camera using an ActiveX control. The ActiveX control must be downloaded from the Internet camera and installed on your PC. Your Internet Explorer security settings must allow for the web page to work correctly. To use the Internet camera, user must setup his IE browser as follows:

### 2.8.1 Internet Explorer 6 for Windows XP

From your IE browse → "Tools" → "Internet Options..." → "Security" → "Custom Level...", please setup your "Settings" as follow.

Set the first 3 items

- *Download the signed ActiveX controls*
- *Download the unsigned ActiveX controls*
- *Initialize and script the ActiveX controls not masked as safe to Prompt*

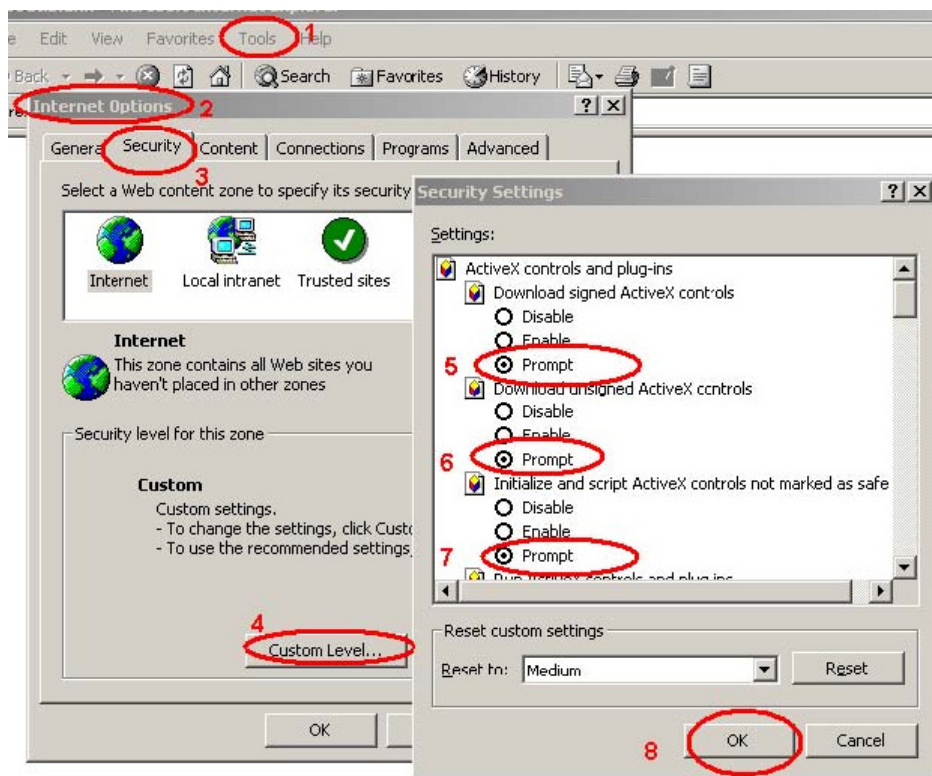

By now, you have finished your entire PC configuration for Internet camera.

## 2.8.2 Internet Explorer 7 for Windows XP

From your IE browse → "Tools" → "Internet Options..." → "Security" → "Custom Level...", please setup your "Settings" as follow.

Set the first 3 items

- *Allow previously unused ActiveX control to run...*
- *Allows Script lets*
- *Automatic prompting for ActiveX controls*

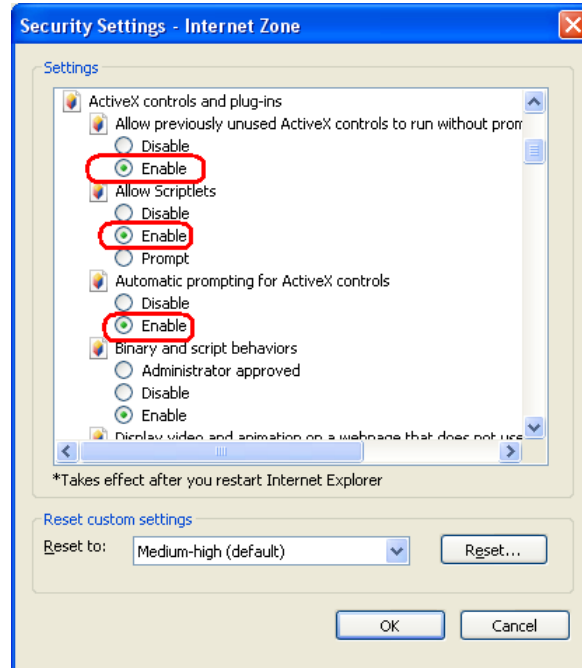

By now, you have finished your entire PC configuration for Internet camera.

### 2.8.3 Internet Explorer 7 for Windows Vista

From your IE browse → "Tools" → "Internet Options..." → "Security" → "Internet" → "Custom Level...", please setup your "Settings" as follow.

- Enable "Automatic prompting for ActiveX controls"
- Prompt "Initialize and script active controls not marked...."

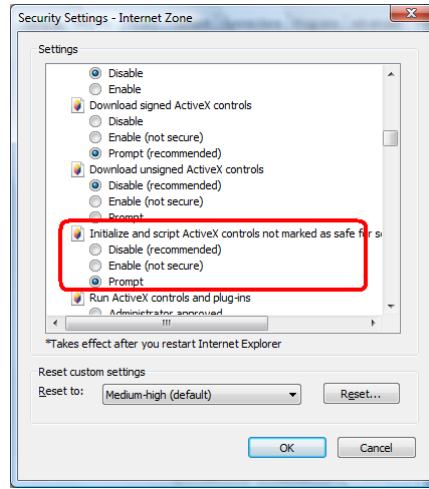
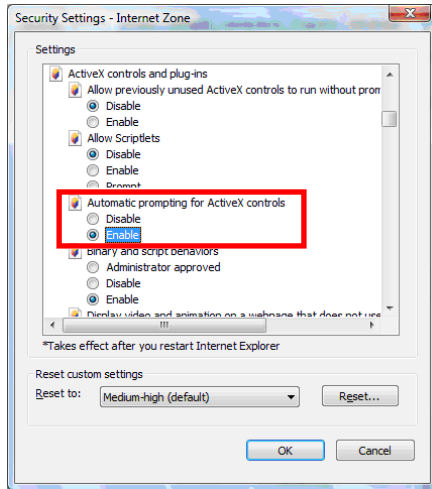

From your IE browse → "Tools" → "Internet Options..." → "Security" → "Trusted Sites" → "Custom Level...", please setup your "Settings" as follow.

- Enable "Automatic prompting for ActiveX controls"
- Prompt "Initialize and script active controls not marked...."

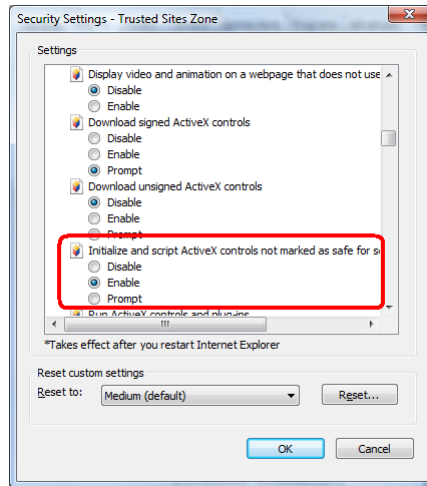
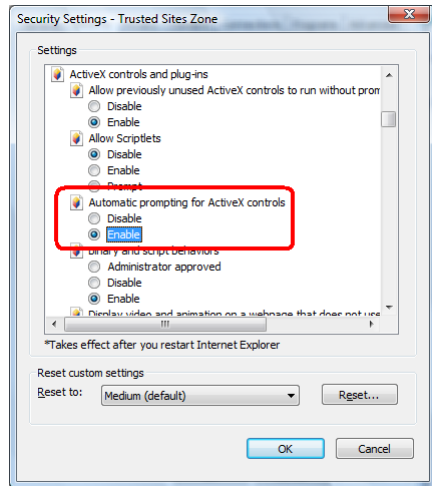

By now, you have finished your entire PC configuration for Internet camera.

## 3. Web-based Management

This chapter provides setup details of the Internet camera's Web-based Interface.

### 3.1 Introduction

The internet camera can be configured with your Web Browser. Before configure, please make sure your PC is under the same IP segment with Internet camera.

### 3.2 Connecting to Internet Camera

- Use the following procedure to establish a connection from your PC to the camera.
- Once connected, you can add the camera to your Browser's Favorites or Bookmarks.

Start the web browser on the computer and type the IP address of the camera. The Default IP: "<http://192.168.0.20>"

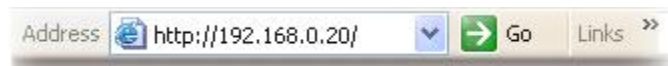

The login window of Internet camera will appear, Default login **username/password** is: **admin/ <no password>**



---

**NOTE:** If the User name and Password have been changed with PLANET IPWizard II, please enter the new User name and Password here.

---

Web browser may display the “Security Warning” window, select “Yes” to install and run the ActiveX control into your PC.

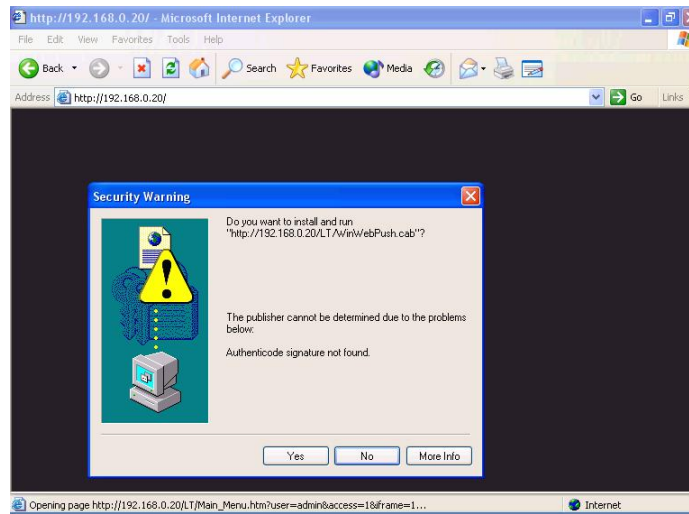

After the ActiveX control was installed and run, the first image will be displayed.

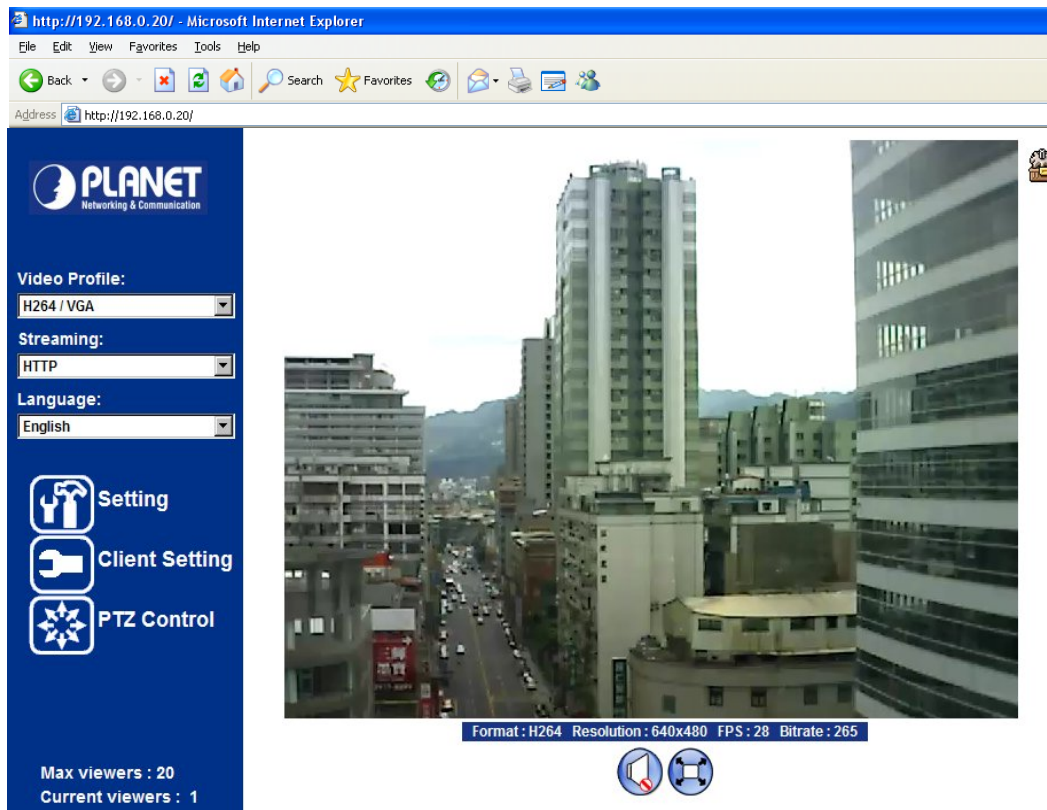

---



**NOTE:** If you log in the camera as an ordinary user, setting function will be not available. If you log in the camera as the administrator, you can perform all the settings provided within the device.

---

### 3.3 Live View

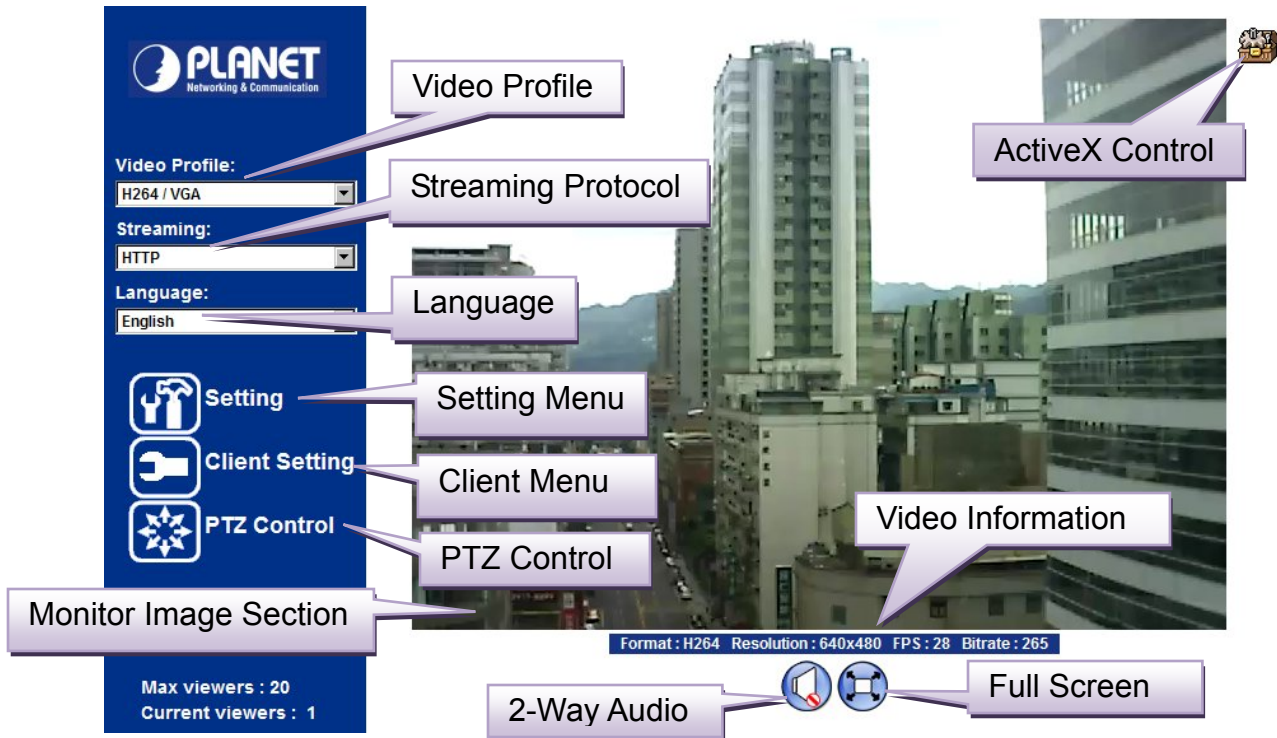
Start-up screen will be as follow no matter an ordinary users or an administrator.



<p><b>Monitor Image Section:</b></p>	<p>The image shot by the camera is shown here. The date and time are displayed at the top of the window.</p>
<p><b>Video Profile:</b></p>	<p>The camera support multi-profile for three compressions H264, MPEG-4 and M-JPEG simultaneously. User can chose the proper and/or preferred profile here.</p>
<p><b>Full Screen</b></p>	<p>Click this button to display the image in full-screen mode (uses every available space to display the image captured by this camera).</p>
<p><b>2-Way Audio:</b></p>	<p>The Internet camera supports 2-way audio function. User can chose to enable or disable this function by toggling the icon below</p> <p>  : Disable audio uploading function.         </p> <p>  : Enable audio uploading function.         </p>

**ActiveX Control:** The plug-in ActiveX control supports a lot of functions by clicking the left mouse button. Note that this feature only supports on the ActiveX control within Microsoft® Internet Explorer.

**Setting Menu:** This function is detail setting for the camera that only available for user logged into camera as administrator.

Item	Action
Network	Configure Network settings such as Wireless, DHCP, DDNS, 3GPP, PPPoE and UPnP.
Camera	Adjust camera parameters.
System	Configure system information, date & time, maintenance, and view system log file.
Video	Configure bit rate and frame rate of video profiles.
Audio	Configure audio parameters.
User	Setup user name, password and login privilege.
E-Mail	Setup E-Mail configuration.
FTP	This device is a client site and configure information to upload images to server.
Object Detection	Setup Object detection.
Event Schedule	Configure the schedule while event triggered.

**Streaming Protocol:** User can select proper streaming protocol according to networking environment.

**Language:** The device could provide multiple languages to meet customer's requirement.

**Video Information:** Display video information including video format, resolution, frame rate and bit rate.

**Client Setting:** Click this button to display the client extra control panel for 2-way Audio and Full Screen.

**PTZ Control:**

Click to display the following control panel:

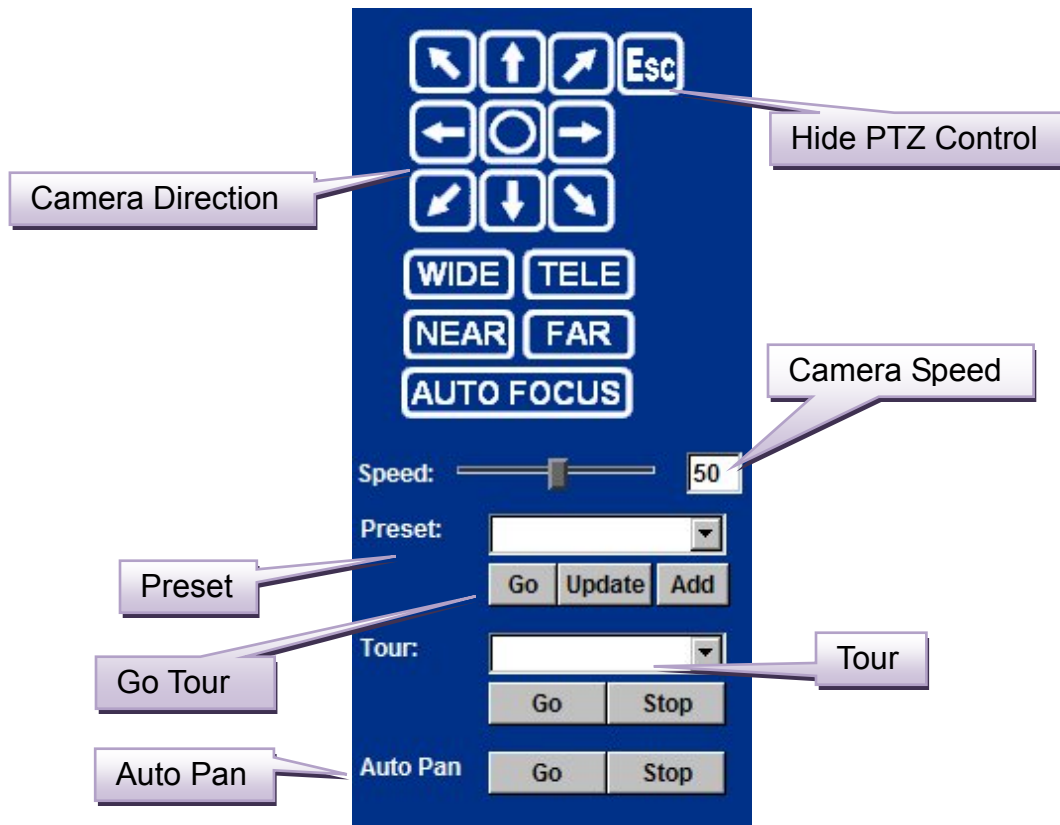

**Hide PTZ Control:** Click the icon will hide the PTZ control function.

**Camera Direction:** Control camera up/down/left/right and home position.

**Camera Speed:** Choose the speed of Pan and Tilt.

**Preset:** Add/Update the preset positions or go to one of these positions.

**Tour:** Select one of the camera tours. Camera tour is comprised by series of preset locations.

**Go Tour:** Execute the selected camera tour.

**Auto Pan:** Execute the auto pan of camera. While auto pan is running, the camera will swing the camera automatically. Note that the speed of auto pan is fixed and cannot be adjustable.

## 3.4 ActiveX Control

The plug-in ActiveX control supports a lot of functions by clicking the left mouse button. Note that this feature only supports on the ActiveX control within Microsoft® Internet Explorer.

On the ActiveX control icon, click the Left Mouse Button, then a menu pop-up. This menu provides features that are unique to the ActiveX control. These features include:

- Digital Zoom,
- Record,
- Snapshot,
- Voice,
- Statistics,
- About



### 3.4.1 Digital Zoom

Click **Digital Zoom** to activate this function as above. User can drag or scale the box over the video to adjust zoom ratio and position.

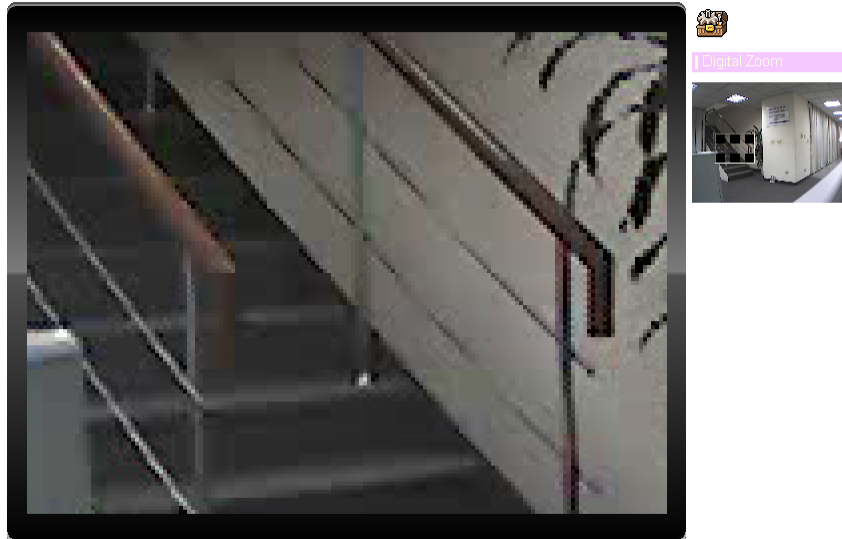

### 3.4.2 Record

Click **Record** to activate this function. Press **Record** button to start recording. The video file is saved as ASF format into your local PC. While you want to stop it, press **Stop** to stop recording. Select **Browser**, the pop-up window to select the save path and file name prefix, select **OK** to continue.

After stop recording, list the files, this file is named as Video\_yyymmddhhmmss.asf

The ASF files can be display by the standard Windows Media Player, but it needs the DixectX 9.0 or later version to be installed.

---

**NOTE:** Default save path is "C:\Documents and Settings\All user\Desktop"

---

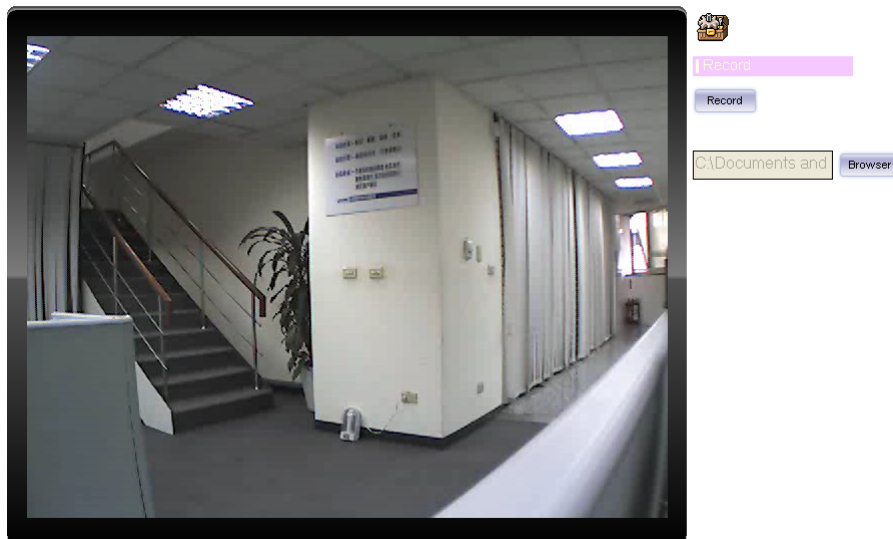

### 3.4.3 Snapshot

Click **Snapshot** to activate this function. Press **Snapshot** button to take a picture. The image file is saved as JPEG format into your local PC. Select **Browser**, the pop-up window to select the save path and file name prefix, select **OK** to continue.

If you like to retrieve the saved image, select the file to display the saved image by using any one of graph editing tools.

---

**NOTE:** Default save path is "C:\Documents and Settings\All user\Desktop"

---

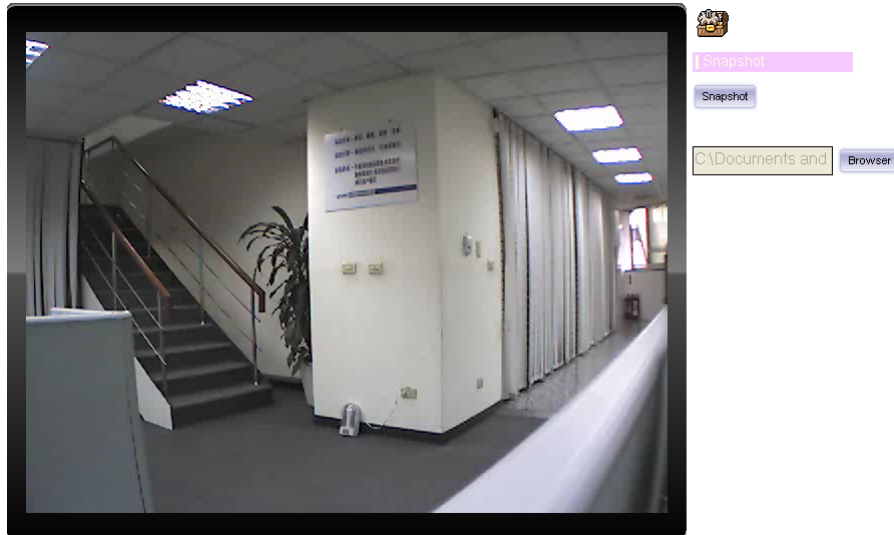

### 3.4.4 Voice

Click Volume to activate this function. These have two control bars for speaker and microphone volume. Scroll this control bar to adjust the audio attribute. Check the volume mute will mute the speaker output.

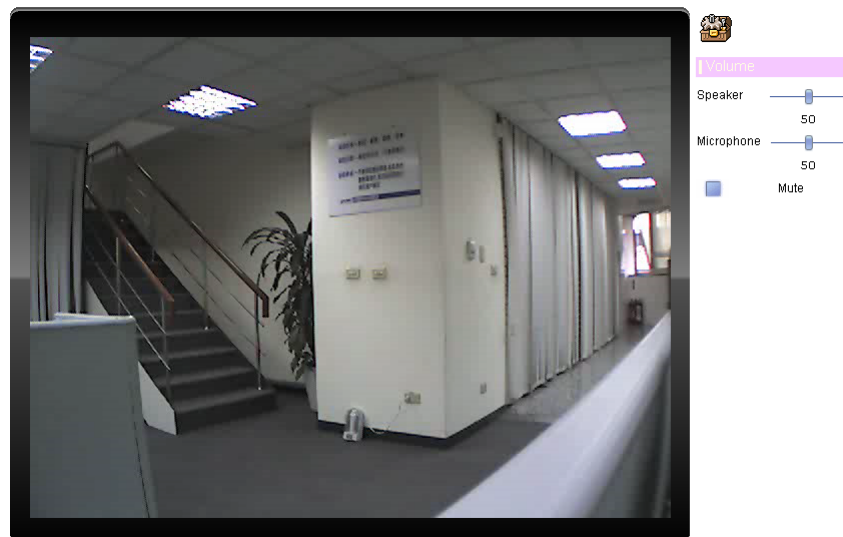

### 3.4.5 Statistics

Click **Statistics** to activate this function. A window will be popup to show the statistics information of the streaming status.

**NOTE:** That this information is the statistics between the device and your local PC.

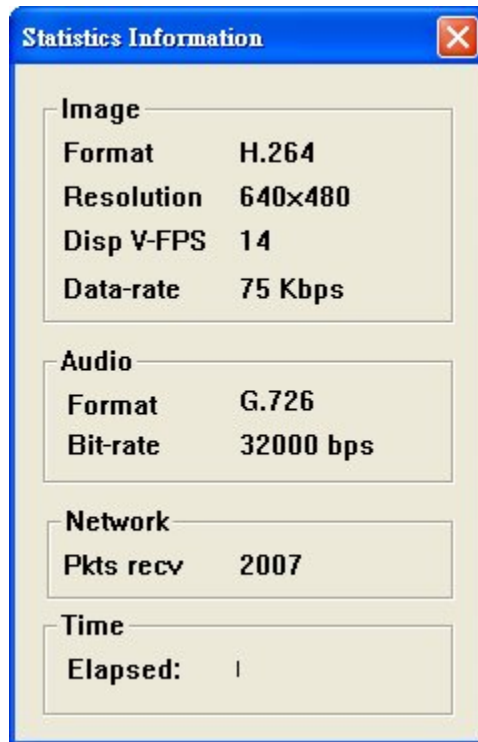

### 3.4.6 About

Click **About** to show the ActiveX information



## 3.5 Network Configuration

Use this menu to configure the network to connect the device and the clients.

### 3.5.1 Network

This section provides the menu of connecting the device through Ethernet cable.

The screenshot shows a network configuration interface with a dark blue background. At the top, there are several tabs: Network (selected), DDNS, PPPoE, Streaming, UPNP, IP Filter, and IP Notification. Below the tabs, the following settings are visible:

- MAC Address: 00:30:4F:A0:00:A3
- Obtain IP address automatically (DHCP)
- IP Address: 192.168.0.20 (with a Test button)
- Subnet Mask: 255.255.255.0
- Gateway: 192.168.0.254
- Obtain DNS from DHCP
- Primary DNS: [empty field]
- Secondary DNS: [empty field]
- HTTP Port: 80 (with a range of 1 - 65535)

**MAC address:** Display the Ethernet MAC address of the device. Note that user cannot change it.

**Obtain an IP address automatically (DHCP):** Enable this checked box when a DHCP server is installed on the network to issue IP address assignment. With this setting, the IP address is assigned automatically. If this device cannot get an IP address within limited tries, the device will assign a default IP address for 192.168.0.20.

If you do not select “Obtain an IP address automatically”, then you need to enter these network parameters by yourself.

**IP Address:** This address is a unique numbers that identifies a computer or device on the WAN or LAN. These numbers are usually shown in groups separated by periods, for example: 192.168.0.200

**Subnet Mask:** Subnets allow network traffic between hosts to be separated based on the network's configuration. In IP networking, traffic takes the form of packets. IP subnets advance network security and performance to some level by organizing hosts into logical groups. Subnet masks contain four bytes and usually appear in the same "dotted decimal" data. For example, a very common subnet mask in its binary demonstration 11111111 11111111 11111111 00000000 will usually be shown in the corresponding, more readable form as 255.255.255.0.

**Gateway:** A gateway is a piece of software or hardware that passes information between networks. You'll see this term most often when you either log in to an Internet site or when you're transient email between different servers.

**Obtain DNS from DHCP:** Enable this checked box when a DHCP server is installed on the network and provide DNS service.

**Primary DNS:** When you send email or position a browser to an Internet domain such as xxxxx.com, the domain name system translates the names into IP addresses. The term refers to two things: the conventions for naming hosts and the way the names are control across the Internet.

**Secondary DNS:** The same function as DNS1. It is option not necessary

**HTTP Port:** The device supports two HTTP ports. The first one is default port 80 and this port is fixed. This port is very useful for Intranet usage. The second HTTP port is changeable. Users could assign the second port number of http protocol, and the WAN users should follow the port number to login. If the http port is not assigned as 80, users have to add the port number in back of IP address. For example: <http://192.168.0.20:8080>.

Therefore, the user can access the device by either

<http://xx.xx.xx.xx/>, or

<http://xx.xx.xx.xx:xxxx/> to access the device.

If multiple devices are installed on the LAN and also required to be accessed from the WAN, then the **HTTP Port** can be assigned as the virtual server port mapping to support multiple devices.

**NOTE :** When the configuration is finish, please click "**OK**" to save and enable the setting.

### 3.5.2 DDNS server

DDNS: Stands for Dynamic Domain Name Server

The device supports DDNS. If your device is connected to xDSL directly, you might need this feature. However, if your device is behind a NAT router, you will not need to enable this feature. Because DDNS allows the device to use an easier way to remember naming format rather than an IP address. The name of the domain is like the name of a person, and the IP address is like his phone number. On the Internet we have IP numbers for each host (computer, server, router, and so on), and we replace these IP numbers to easy remember names, which are organized into the domain name. As to xDSL environment, most of the users will use dynamic IP addresses. If users want to set up a web or a FTP server, then the Dynamic Domain Name Server is necessary. For more DDNS configuration, please consult your dealer.

Your Internet Service Provider (ISP) provides you at least one IP address which you use to connect to the Internet. The address you get may be static, meaning it never changes, or dynamic, meaning it's likely to change periodically. Just how often it changes, depends on your ISP. A dynamic IP address complicates remote access since you may not know what your current WAN IP address is when you want to access your network over the Internet. The solution to the dynamic IP address problem comes in the form of a dynamic DNS service.

The Internet uses DNS servers to lookup domain names and translates them into IP addresses. Domain names are just easy to remember aliases for IP addresses. A dynamic DNS service is unique because it provides a means of updating your IP address so that your listing will remain current when your IP address changes. There are several excellent DDNS services available on the Internet and best of all they're free to use. One such service you can use is [www.DynDNS.org](http://www.DynDNS.org). You'll need to register with the service and set up the domain name of your choice to begin using it. Please refer to the home page of the service for detailed instructions or refer to Appendix E for more information.

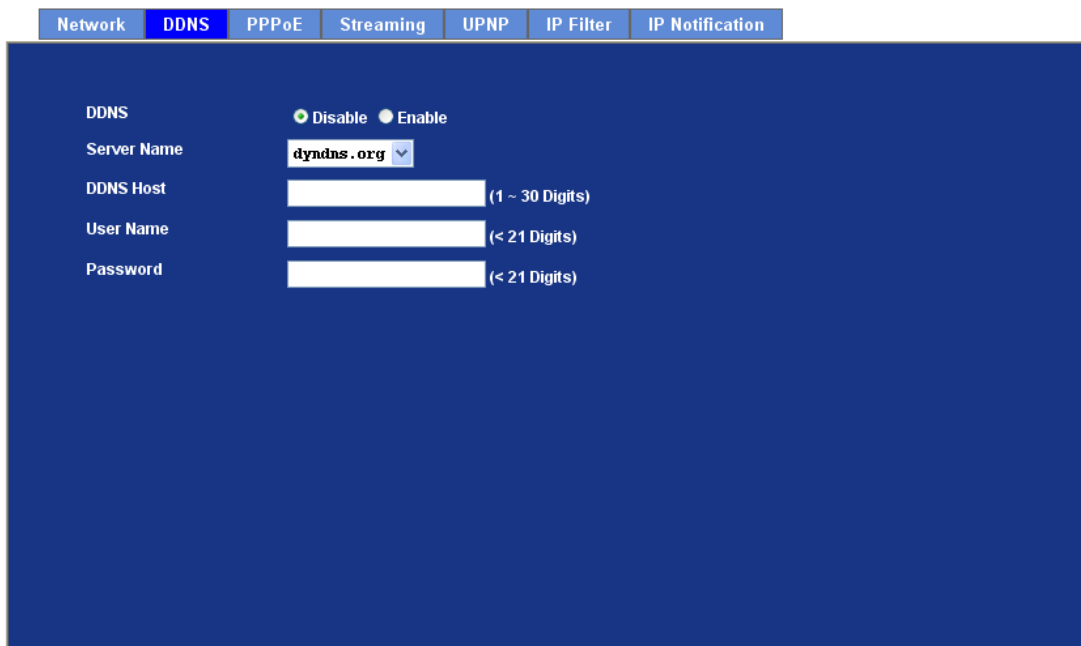

The screenshot shows a network configuration interface with a dark blue background. At the top, there is a horizontal menu with tabs for 'Network', 'DDNS', 'PPPoE', 'Streaming', 'UPNP', 'IP Filter', and 'IP Notification'. The 'DDNS' tab is currently selected. Below the menu, the 'DDNS' section is visible. It includes a radio button control for 'Disable' (selected) and 'Enable'. Below this are four input fields: 'Server Name' with a dropdown menu showing 'dyndns.org', 'DDNS Host' with a text input field and a note '(1 ~ 30 Digits)', 'User Name' with a text input field and a note '< 21 Digits', and 'Password' with a text input field and a note '< 21 Digits'.

**DDNS:** To enable or disable the DDNS service here.

**Server name:** Choose the built-in DDNS server.

**DDNS Host:** The domain name is applied of this device.

**User Name:** The user name is used to log into DDNS.

**Password:** The password is used to log into DDNS.

### 3.5.3 PPPoE

PPPoE: Stands for Point to Point Protocol over Ethernet

A standard builds on Ethernet and Point-to-Point network protocol. It allows Internet camera connect to Internet with xDSL or cable connection; it can dial up your ISP and get a dynamic IP address. For more PPPoE and Internet configuration, please consult your ISP.

It can directly connect to the xDSL, however, it should be setup on a LAN environment to program the PPPoE information first, and then connect to the xDSL modem. Power on again, then the device will dial on to the ISP connect to the WAN through the xDSL modem.

The procedures are

- Connect to a LAN by DHCP or Fixed IP
- Access the device, enter **Setting** → **Network** → **PPPoE** as below

The screenshot shows a web interface for configuring PPPoE. At the top, there is a navigation bar with tabs: Network, DDNS, PPPoE (selected), Streaming, UPNP, IP Filter, and IP Notification. Below the navigation bar, the PPPoE configuration page is displayed. It features a toggle switch for PPPoE, currently set to 'Disable'. Below the toggle, there are input fields for 'User Name' and 'Password', both with a character limit of '< 21 Digits'. There are also input fields for 'IP Address', 'Subnet Mask', and 'Gateway'. At the bottom, the 'Status' is shown as 'Disconnect'.

<b>PPPoE:</b>	To enable or disable the PPPoE service here.
<b>User Name:</b>	Type the user name for the PPPoE service which is provided by ISP.
<b>Password:</b>	Type the password for the PPPoE service which is provided by ISP.
<b>IP Address / Subnet Mask / Gateway:</b>	Shows the IP information got from PPPoE server site.
<b>Status:</b>	Shows the Status of PPPoE connection.

### 3.5.4 Streaming

RTSP is a streaming control protocol, and a starting point for negotiating transports such as RTP, multicast and Unicast, and for negotiating codecs. RTSP can be considered a "remote control" for controlling the media stream delivered by a media server. RTSP servers typically use RTP as the protocol for the actual transport of audio/video data.

Network	DDNS	PPPoE	<b>Streaming</b>	UPNP	IP Filter	IP Notification
RTSP Port	<input type="text" value="554"/>		(554 ~ 65535)			
RTP Port	<input type="text" value="50000"/>	~	<input type="text" value="50999"/>	(1024 ~ 65535)		

**RTSP Port:** Choose the RTSP port. The RTSP protocol allows a connecting client to start a video stream. Enter the RTSP port number to use. The default value is 554.

**RTP Port:** Specify the range of transmission port number of video stream. The default range is 50000 to 50999. User can specify a number between 1024 and 65535.

- NOTE:**
1. To use the 3GPP function, in addition to previous section, you might need more information or configuration to make this function work.
  2. The camera must be set as Multi-profile mode, not Mega-pixel mode. Otherwise this device cannot serve 3GPP stream.
  3. To use the 3GPP function, it strongly recommends installing the Networked Device with a public and fixed IP address without any firewall protection.
  4. Port 554 is the default for RTSP service. However, sometimes, some service providers change this port number for some reasons. If so, user needs to change this port accordingly.

- Dialing procedure:**
1. Choose a verified player (PacketVideo, QuickTime or Real player currently)
  2. Use the following URL to access: **rtsp://host/mpeg4/media.3gp**  
Where host is the host name or IP address of the camera.

**Compatible 3G mobile phone:** Please contact your dealer to get the approved list of compatible 3G phone.

### 3.5.5 UPnP

UPnP is short for Universal Plug and Play, which is a networking architecture that provides compatibility among networking equipment, software, and peripherals. This device is an UPnP enabled Network Camera. If your operating system is UPnP enabled, the device will automatically be detected and a new icon will be added to “My Network Places.” If you do not want to use the UPnP functionality, it can be disabled

In addition, this device also provides UPnP IGD function for NAT traversal easily. Use NAT traversal when your device is located on an intranet (LAN) and you wish to make it available from the other (WAN) side of a NAT router. With NAT traversal properly configured, all HTTP traffic to an external HTTP port in the NAT router will be forwarded to the device.

Network DDNS PPPoE Streaming **UPnP** IP Filter IP Notification

UPnP  Disable  Enable

Friendly Name

UPnP NAT Traversal  Disable  Enable

Port Range  -  (1024 ~ 65535)

External IP Address  (readonly)

**UPnP:** To enable or disable the UPnP service here.

**Friendly Name:** Shows the friendly name of this device here.

**UPnP NAT Traversal:** When enabled, the device will attempt to configure port mapping in a NAT router on your network, using UPnP™. Note that UPnP™ must be enabled in the NAT router first.

**Port Range:** The port range will open in NAT router.

**External IP address:** Show the IP address and port for WAN access through Internet. If NAT traversal is configured successfully, user can use this IP address and port to access this device.

### 3.5.6 IP Filter

You can enter different user's IP address which are allowing enter or denying by the device.

The screenshot shows a web interface for configuring IP filtering. At the top, there is a navigation bar with tabs for Network, DDNS, PPPoE, Streaming, UPNP, IP Filter (selected), and IP Notification. The main content area has a dark blue background. It contains the following elements:

- IP Filter:** A radio button for 'Disable' (selected) and a radio button for 'Enable'.
- IP Filter Policy:** A radio button for 'Deny' and a radio button for 'Allow' (selected).
- Save:** A button to save the configuration.
- Filter IP List:** A table with a header 'Filter IP List' and a single row with a 'Filter IP' label and an empty text input field.
- Buttons:** 'Add', 'Delete', and 'DeleteAll' buttons located below the input field.

**IP Filter:** To enable or disable the IP filter function here.

**IP Filter Policy:** Choose the filter policy where is denying or allowing.

### 3.5.7 IP Notification

In case the IP address is changed, system is able to send out an email to alert someone if the function is enabled.

#### SMTP Notification (e-mail):

If enable this function, then the “**Send to**” and “**Subject**” field need to be filled.

#### Send To:

Type the receiver’s e-mail address. This address is used for reply mail.

#### Subject:

Type the subject/title of the E-mail.

#### TCP Notification:

If enable this function, then the “**TCP Server**“, “**TCP Port**”, and “**Message**” fields need to be filled.

#### TCP Server:

Type the server name or the IP address of the TCP server.

#### TCP Port:

Set port number of TCP server.

#### Message:

The message will be sent to FTP server.

#### HTTP Notification:

If enable this function, then the fields below need to be filled.

#### URL:

Type the server name or the IP address of the HTTP server

<b>HTTP Login name:</b>	Type the user name for the HTTP server.
<b>HTTP Login Password:</b>	Type the password for the HTTP server.
<b>Proxy Address:</b>	Type the server name or the IP address of the HTTP Proxy.
<b>Proxy Port:</b>	Set port number of Proxy.
<b>Proxy Login name:</b>	Type the user name for the HTTP Proxy.
<b>Proxy Login Password:</b>	Type the password for the HTTP Proxy.
<b>Custom parameter:</b>	User can set specific parameters to HTTP server.
<b>Message:</b>	The message will be sent to HTTP server.

## 3.6 Camera Configuration

Use this menu to set the function of the camera of Internet camera

### 3.6.1 Picture

Picture PTZ Setting Preset Setting Tour Setting

Rotation

White Balance

Exposure Control  Auto  Hold

Color Level  (0 ~ 100)

Brightness  (0 ~ 100)

Contrast  (0 ~ 100)

Sharpness  (0 ~ 100)

Night Mode  Auto  Off

De-Noise

ICR  Night Mode  Day mode  
 Auto  Schedule

Current Value  Refresh

Night Mode Threshold  (0 ~ 10000)

Day Mode Threshold  (0 ~ 10000)

Delay Time  (0 ~ 86400)



#### Rotation:

Turn the “Mirror” and “Vertical Flip” On or OFF. The image will be overturned as below.

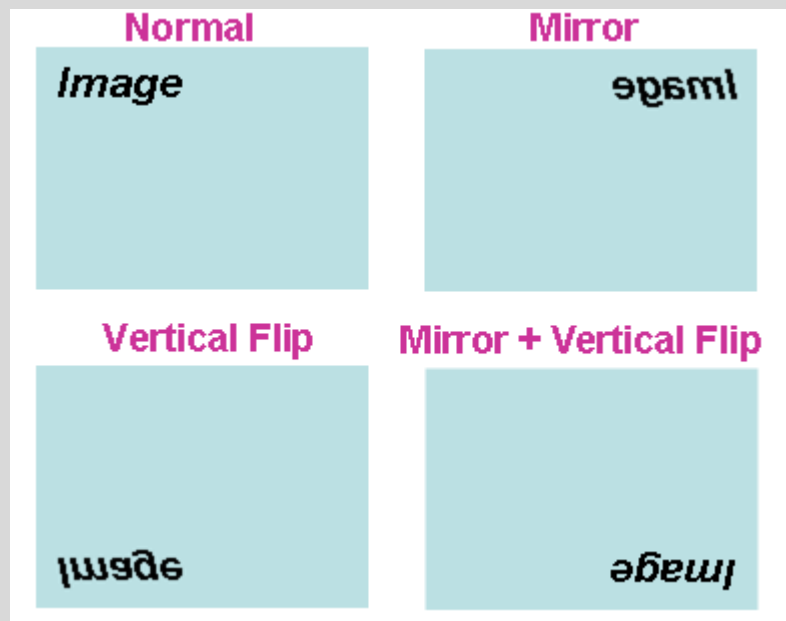

**White Balance:**                      **Auto:** will adjust the white balance automatically.  
**Hold:** will hold the white balance.

**Exposure Control:**                **Auto:** will adjust the internal gain automatically.  
**Hold:** will hold the internal gain.

**Color Level**                            Large value will be colorful.

**Brightness:**                        Large value will brighten camera.

**Sharpness:**                        Large value will sharpen camera.

**Contrast:**                            Large value will contrast camera heavily.

**Night Mode:**                        User can turn Auto or Off of the night mode. This function is very useful under low illumination environment.

**De-Noise:**                            De-Noise can remove or lower unwanted noise and preserve fine details and edges.

**ICR:**                                    This is an optional function by model. In case, the camera is built-in ICR, user can configure these parameters to control ICR function. There are 4 modes of ICR: Night, Day, Auto and Schedule. In case the Auto mode is selected, user needs to specify 3 parameters in advance:

**Night Mode Threshold (0~10000):**

this value set the threshold to activate night mode. It should be lower or equal to Day Mode Threshold.

**Day Mode Threshold (0~10000):**

this value set the threshold to activate day mode. It should be higher or equal to Night Mode Threshold.

**Delay Time:** The delay time between ICR switching.

**Note** that Current Value is the current luminance from the captured video. It's a useful reference to set Day/Night Mode Threshold.

### 3.6.2 PTZ Setting

This page allow user to modify the RS-485 interface according to the P/T scanner..

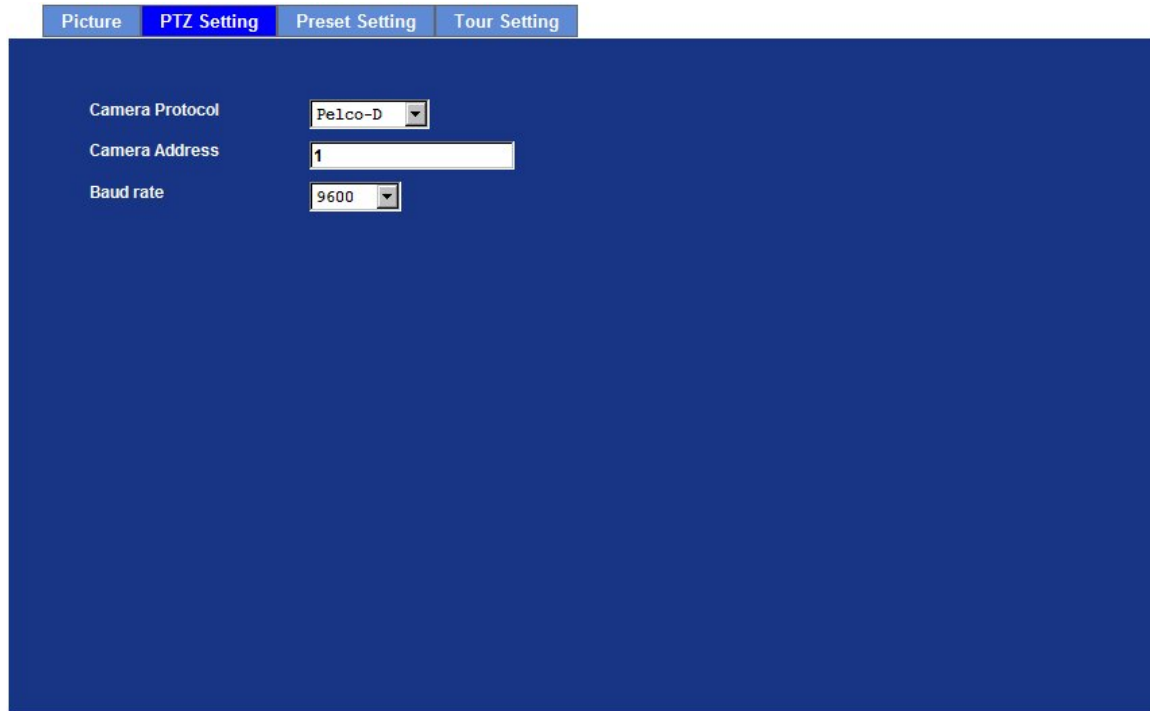

**Camera Protocol:** This device can connect to a PTZ camera or speed dome camera and controls them thru RS-485 interface.

**Camera Address:** This is the camera ID set in PTZ camera or speed dome camera.

**Note** that please DO NOT change the default value if unnecessary. If so, user needs to check and set value properly for both sides.

**Baud rate:** This is the communication speed between network module and P/T scanner.

**NOTE:** If need to change these parameters, user needs to check and set value properly for both, network module and P/T scanner.

### 3.6.3 Preset Setting

This page provides the edit tool to modify or delete the “Preset Setting” item by item.

Picture PTZ Setting **Preset Setting** Tour Setting

Preset Number	Preset Name	Home Position

Preset List	
Preset Number	<input type="text"/>
Preset Name	<input type="text"/>
Home Position	<input checked="" type="radio"/> Enable <input type="radio"/> Disable
<input type="button" value="Modify"/> <input type="button" value="Delete"/>	

### 3.6.4 Tour Setting

Up to 64 positions can be preset, and the camera can be programming to move to the preset position sequentially.

Picture PTZ Setting Preset Setting **Tour Setting**

Tour Number	Tour Name	Running	Sequence	Preset Name	Wait Time

Tour Name	<input type="text"/>	Presets	<input type="text"/>
Running	<input checked="" type="radio"/> Enable <input type="radio"/> Disable	Wait Time	<input type="text" value="10"/> Seconds
<input type="button" value="Add"/> <input type="button" value="Modify"/> <input type="button" value="Delete"/>		<input type="button" value="Add"/> <input type="button" value="Modify"/> <input type="button" value="Delete"/>	

<b>Tour Name:</b>	The group name of the sequence of camera tour. The maximum number of camera tour is 16.
<b>Running:</b>	Enable or disable this camera tour.
<b>Preset:</b>	Set the sequence of the tour. Maximum 16 points can be assigned. The selected preset position is added in the Sequence list from 1 to 16.
<b>Wait Time:</b>	Type a period of time during which the camera is to stay at each preset point, between 0 to 36000 seconds.
<b>NOTE:</b>	To use the camera tour function, user must preset some camera positions first. The maximum number of preset points is 64.

## 3.7 System

Use this menu to perform the principal settings of Internet camera.

### 3.7.1 System

The screenshot shows the 'System' configuration page for a device named 'ICA-HM130'. The page has a dark blue background and a top navigation bar with three tabs: 'System', 'Date & Time', and 'Maintenance'. The 'System' tab is selected. Below the tabs, there are several configuration options: 'Device Title' (ICA-HM130), 'Software Version' (5.0.0.3356), 'Network LED' (radio buttons for Enable and Disable), 'Power LED' (radio buttons for Enable and Disable), and a 'Log' section with a 'Reload' button. A scrollable log window shows system messages including syslogd startup, kernel notices, and warnings about CPU, memory, and cache settings.

**Device title:** You can enter the name of this unit here. It's very useful to identify the specific device from multiple units.

**Software version:** This information shows the software version in the device.

**Network LED:** Switch the LED light of this Internet camera on or off, that Network LEDs will stop working, in case you don't want other people know the camera is transferring data.

**Power LED:** Switch the LED light of this Internet camera on or off.

**Log:** User can check the system log information of the device, including the Main Info, Appended Info, Operator IP, and so on ...

**Reload:** Click this button; user can refresh the log information of the device.

### 3.7.2 Date & Time

You can setup the time setting of Internet camera, make it synchronized with PC or remote NTP server. Also, you may select the correct time zone of your country.

<b>Server Date &amp; Time:</b>	Displays the date and time of the device	
<b>PC Time:</b>	Displays the date and time of the connected PC	
<b>Adjust:</b>	<b>Synchronize with PC:</b>	Click this option to enable time synchronization with PC time
	<b>Manual setting:</b>	Click this option to set time and date manually
	<b>Synchronize with NTP:</b>	Click this option if you want to synchronize the device's date and time with those of time server called NTP server (Network Time Protocol)
<b>NTP server name:</b>	Type the host name or IP address or domain name of the NTP server.	
<b>NTP sync. Interval:</b>	Select an interval between 1 and 23 hours at which you want to adjust the device's time referring to NTP server	
<b>Time zone:</b>	Set the time difference from Greenwich Mean Time in the area where the device is installed.	
<b>Daylight saving:</b>	Check this item to enable daylight saving adjustment.	

**Daylight Saving Start Time:** Sets up the date and time of daylight saving start time.

**Start Time:**

**Daylight Saving Stop Time:** Sets up the date and time of daylight saving stop time.

**Stop Time:**

**Daylight Saving Offset:** Sets up the date of daylight saving offset.

**Offset:**

### 3.7.3 Maintenance

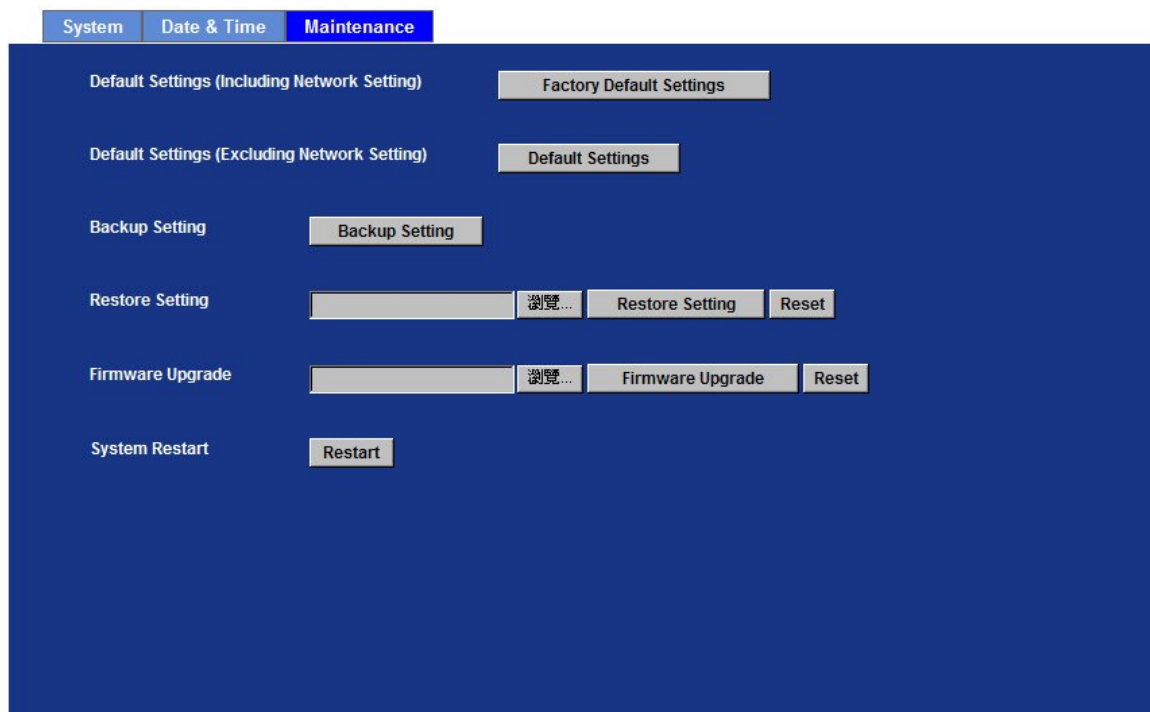

**Default Settings (Include the network setting):**

Recall the device hard factory default settings. Note that click this button will reset all device's parameters to the factory settings (including the IP address).

**Default Settings (Except the network setting):**

The unit is restarted and most current settings are reset to factory default values. This action will not reset the network setting.

**Backup Setting:**

To take a backup of all of the parameters, click this button. If necessary, it will then be possible to return to the previous settings, if settings are changed and there is unexpected behavior.

**Restore Setting:** Click the “Browse” button to locate the saved backup file and then click the “Restore Setting” button. The settings will be restored to the previous configuration.

**Firmware upgrade:** The device supports new firmware upgrade.

1. Close all other application programs which are not necessary for firmware update.
2. Make sure that only you access this device at this moment
3. Disable Motion Detection function.
4. Select “**Firmware name**”
5. Select the Firmware binary file.

**Note:** That it must make sure that the Firmware only applies to this device, once update, it will be burned into FLASH ROM of system.

6. Once the firmware file was selected, select “Upgrade”.
7. The upgrade progress information will be displayed on the screen.
8. A message will be shown while the firmware upgraded. Once the upgrading process completed, the device will reboot the system automatically.
9. Please wait for 80 seconds, and then you can use PLANET IPWizard II to search the device again.

**Warning!!!** The download firmware procedure cannot be interrupted. If the power and/or network connection are broken during the download procedure, it might possibly cause serious damage to the device.

Please be aware that you should not turn off the power during updating the firmware and wait for finish message.

Furthermore, do not try to upgrade new firmware if it's not necessary.

**System Restart:** The device is restarted without changing any of the settings.

## 3.8 Video

This device provides more video profiles as below to support different request to each client simultaneously. Each user can choose his preferred video profile as his request independently.

### 3.8.1 Common

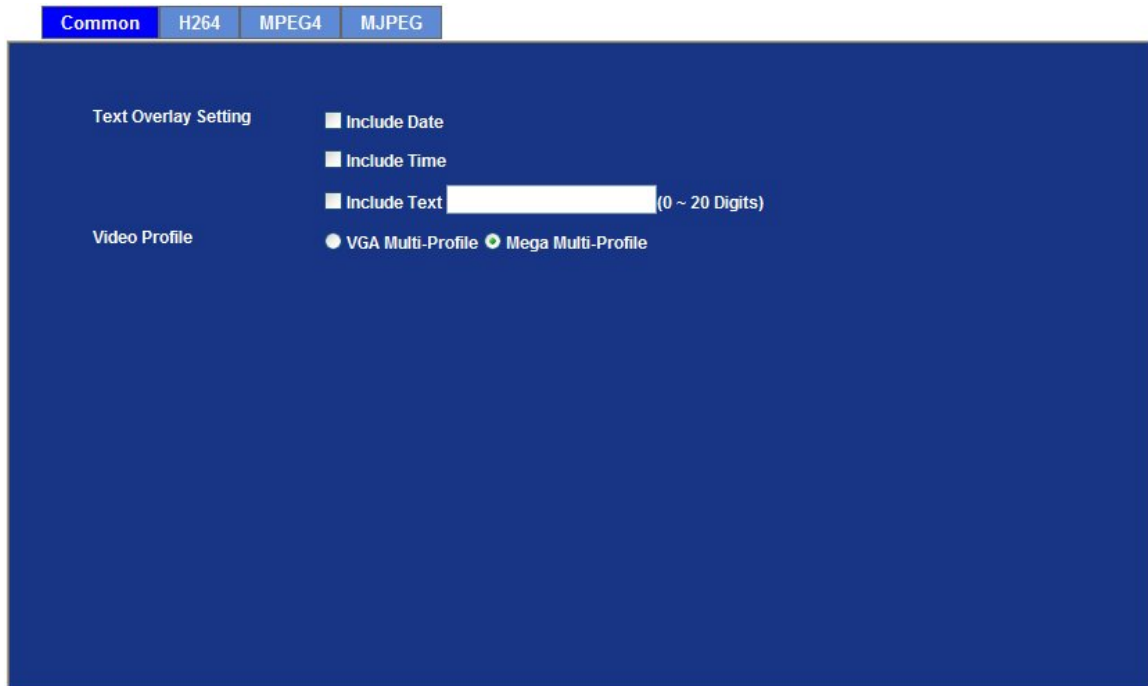

The screenshot shows a settings interface with a dark blue background. At the top, there are four tabs: 'Common' (selected), 'H264', 'MPEG4', and 'MJPEG'. Below the tabs, there are two sections: 'Text Overlay Setting' and 'Video Profile'. Under 'Text Overlay Setting', there are three checkboxes: 'Include Date', 'Include Time', and 'Include Text'. The 'Include Text' checkbox is checked, and there is a text input field next to it with the placeholder '(0 ~ 20 Digits)'. Under 'Video Profile', there are two radio buttons: 'VGA Multi-Profile' and 'Mega Multi-Profile'. The 'Mega Multi-Profile' radio button is selected.

**Text Overlay Setting:** There are some important information can be embedded into image, including date, time, and/or text.

**Video Profile:** User can only choose either VGA Multi-profile or Mega Multi-profile mode. VGA Multi-profile mode can serve H.264, MPEG-4, and M-JPEG streams up to VGA resolution simultaneously. On the other hand, Mega-pixel mode, in addition to VGA resolution, it can serve H.264/Mega and M-JPEG/Mega two more streams simultaneously. When you set to Mega mode, the max. frame rate will be 15fps.

### 3.8.2 H264 Profile

It's H.264 encoder mode in this profile.

The screenshot shows a configuration interface for an H.264 encoder. At the top, there are four tabs: 'Common', 'H264' (selected), 'MPEG4', and 'MJPEG'. Below the tabs, there are three sections, each representing a different resolution profile:

- sxga profile:**
  - Resolution: sxga
  - Rate Control: Quality (selected) 90 (1 ~ 100), Bitrate 3072 K bps (384 ~ 4096)
  - Max Frame Rate: 15
  - GOP Control: 30
- vga profile:**
  - Resolution: vga
  - Rate Control: Quality (selected) 90 (1 ~ 100), Bitrate 2048 K bps (384 ~ 4096)
  - Max Frame Rate: 15
  - GOP Control: 30
- qvga profile:**
  - Resolution: qvga
  - Rate Control: Quality (selected) 90 (1 ~ 100), Bitrate 1024 K bps (128 ~ 2048)
  - Max Frame Rate: 15
  - GOP Control: 30

**Resolution:** There are four resolutions in this profile: SXGA, VGA, QVGA and QQVGA.

**Rate Control:** Defines the rate control method of this profile. There are two options: Constant Bit Rate (CBR) or Variable Bit Rate (VBR). For CBR, the video bit rate is between low to high bandwidth based on different resolutions. User can set the desired bit rate to match the limitation of bandwidth. For VBR, user should choose the quality level to set the video quality rather than bit rate. The quality level is between 1 and 100. The higher value can reach the better quality but of course will consume higher bandwidth.

**Max Frame Rate:** Defines the targeted frame rate of this profile. For example, set the frame rate to 15 fps, then the image will be updated for 15 frames per second. User can set the desired max frame rate versus video quality under the limited bandwidth.

**GOP Control:** Defines the Intra/Inter-frame (I/P) ratio of this profile. For example, set the GOP to 30, then the video stream will have one Intra-frame every 30 frames.

### 3.8.3 MPEG4 Profile

It's MPEG4 encoder mode in this profile.

The screenshot shows a configuration window for the MPEG4 profile. At the top, there are four tabs: 'Common', 'H264', 'MPEG4', and 'MJPEG'. The 'MPEG4' tab is selected. Below the tabs, there are three sections, each corresponding to a different resolution:

- vga:** Resolution: vga. Rate Control: Quality 90 (1 ~ 100) selected, Bitrate 2048 K bps (384 ~ 4096) unselected. Max Frame Rate: 15. GOP Control: 30.
- qvga:** Resolution: qvga. Rate Control: Quality 90 (1 ~ 100) selected, Bitrate 1024 K bps (128 ~ 2048) unselected. Max Frame Rate: 15. GOP Control: 30.
- qqvga:** Resolution: qqvga. Rate Control: Quality 90 (1 ~ 100) selected, Bitrate 512 K bps (24 ~ 512) unselected. Max Frame Rate: 15. GOP Control: 30.

**Resolution:** There are three resolutions in this profile: VGA, QVGA and QQVGA.

**Rate Control:** Defines the rate control method of this profile. There are two options: Constant Bit Rate (CBR) or Variable Bit Rate (VBR). For CBR, the video bit rate is between low to high bandwidth based on different resolutions. User can set the desired bit rate to match the limitation of bandwidth. For VBR, user should choose the quality level to set the video quality rather than bit rate. The quality level is between 1 and 100. The higher value can reach the better quality but of course will consume higher bandwidth.

**Max Frame Rate:** Defines the targeted frame rate of this profile. For example, set the frame rate to 15 fps, then the image will be updated for 15 frames per second as possible. User need to set reasonable max frame rate versus video quality under the limited bandwidth.

**GOP Control:** Defines the Intra/Inter-frame (I/P) ratio of this profile. For example, set the GOP to 30, then the video stream will have one Intra-frame every 30 frames.

### 3.8.4 MJPEG Profile

It's M-JPEG mode in this profile.

**Resolution:** There are four resolutions in this profile: SXGA, VGA, QVGA and QQVGA.

**Rate Control:** The quality level is between 1 and 100. The higher value can reach the better quality but of course will consume higher bandwidth.

**Max Frame Rate:** Defines the targeted frame rate of this profile. For example, set the frame rate to 15 fps, then the image will be updated for 15 frames per second as possible. User need to set reasonable max frame rate versus video quality under the limited bandwidth.

## 3.9 Audio Configuration

Setting

Audio	<input type="radio"/> Disable <input checked="" type="radio"/> Enable
Mute While PT	<input type="radio"/> Disable <input checked="" type="radio"/> Enable
Audio Mode	<input type="radio"/> Simplex <input checked="" type="radio"/> Full duplex
Input Gain	0
Output Gain	60

**Audio:** To enable or disable audio function

**Mute While PT** Mute the audio while pan and/or tilt motion

**Audio Mode:** To select Simplex or Full duplex (2-way audio) mode

**Input Gain:** To adjust gain of input audio

**Output Gain:** To adjust gain of output audio

## 3.10 User Privilege Access Configuration

Use this menu to set the user names and password of the Administrator and up to 10 users, and access right of each user.

The screenshot shows a configuration interface for 'Viewer Login'. At the top, there are radio buttons for 'Anonymous' (selected) and 'Only users in database', along with a 'Save' button. Below this is a table with two columns: 'User Name' and 'Access Right'. The first row contains 'admin' and 'administrator'. To the right of this table is a 'User List' form with the following fields:

User List	
User Name	<input type="text"/> (1 ~ 20 Digits)
Password	<input type="text"/> (0 ~ 12 Digits)
Verify Password	<input type="text"/> (0 ~ 12 Digits)
Access Right	<input type="radio"/> Administrator <input checked="" type="radio"/> Viewer
<input type="button" value="Add"/> <input type="button" value="Modify"/> <input type="button" value="Delete"/>	

### Viewer login:

Select "Anonymous" to allow any one viewing the video once connected. Otherwise, only users in database can view the video after login.

### Access right:

Administrator can access every function in this device. However, Viewers only can view the video and access limited function.

### Add, update, and remove of Users account:

Manage the user's account of viewer user.

## 3.11 E-Mail Configuration

You may setup SMTP mail parameters for further operation of Event Schedule. That's, if users want to send the alarm message out, it will need to configure parameters here and also add at least one event schedule to enable event triggering.

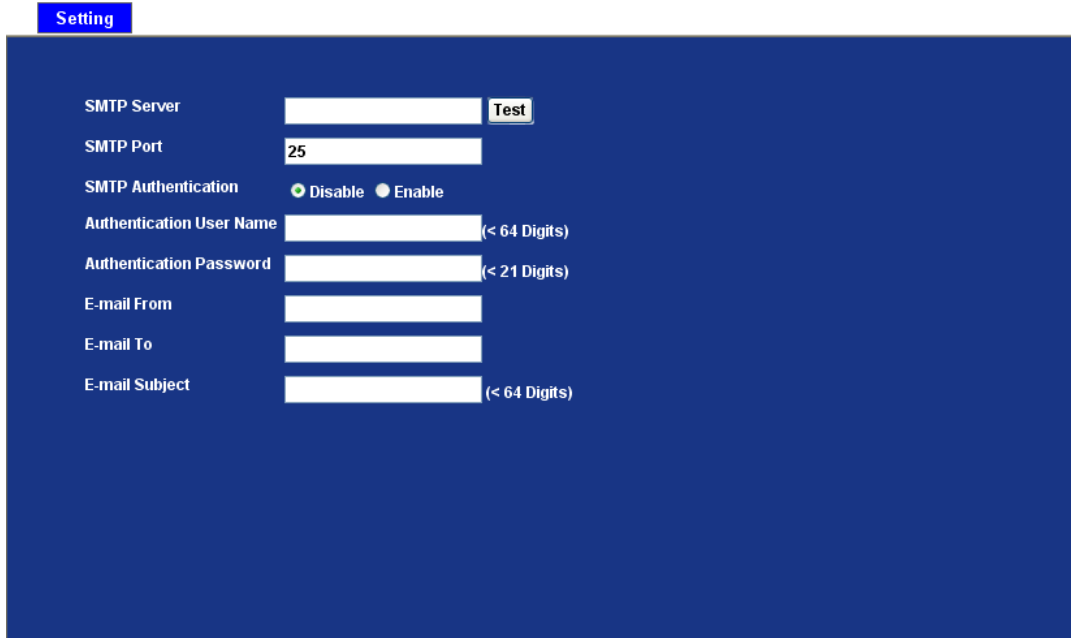

**SMTP Server:** Type the SMTP server name or the IP address of the SMTP server.

**Test:** Send a test mail to mail server to check this account is available or not.

**SMTP Port:** Set port number of SMTP service.

Select the authentication required when you send an e-mail.

**SMTP Authentication:** **Disable:** If no authentication is required when an e-mail is send.  
**Enable:** If authentication is required when an e-mail is sent.

**Authentication Name:** **User** Type the user name for the SMTP server if Authentication is Enabling.

**Authentication Password:** Type the password for the SMTP server if Authentication is Enabling.

**E-mail From:** Type the sender's E-mail address. This address is used for reply e-mails.

**E-mail To:** Type the receiver's e-mail address.

**E-mail Subject:** Type the subject/title of the e-mail.

## 3.12 Object Detection

Use this menu to specify motion detection window 1 to window 4 and set the conditions for detection while observing a captured image.

**Motion Detection**



The screenshot displays a video feed of a hallway with a staircase on the left. A control panel on the right side of the interface includes a dropdown menu, 'Add' and 'Delete' buttons, radio buttons for 'Included' and 'Excluded' window types, a 'Name' input field, 'Object Size (0 ~ 100)' and 'Sensitivity (0 ~ 100)' input fields, and a 'Save' button.

**Add and Del:** To add or delete the motion windows. User can specify up to 4 Included and/or Excluded windows to monitor the video captured by this device. By dragging mouse on the image, you can change the position and size of the selected motion window accordingly.

**Included or Excluded Window:** These windows can be specified as Included or Excluded type.

**Included:**  
Windows target specific areas within the whole video image

**Excluded:**  
Windows define areas within an Include window that should be ignored (areas outside Include windows are automatically ignored)

<b>Name:</b>	Name of the specified motion window.
<b>Object Size:</b>	Defines the object size of motion detection. The higher object size will only larger objects trigger motion detection. The lower object size will even small objects trigger motion detection too. Generally speaking, the smaller size will be easier to trigger event.
<b>Sensitivity</b>	Defines the sensitivity value of motion detection. The higher value will be more sensitivity.

### 3.13 Event Server Configuration

#### 3.13.1 FTP Server

You may setup FTP parameters for further operation of Event Schedule. That's, if users want to send the alarm message to an FTP server, it will need to configure parameters here and also add at least one event schedule to enable event triggering as SMTP.

The screenshot shows a configuration window for the FTP Server. At the top, there are four tabs: 'FTP Server' (selected), 'TCP Server', 'HTTP Server', and 'SAMBA Server'. Below the tabs is a table with the following columns: 'Name', 'FTP Server', 'FTP Port', and 'FTP Path'. The table is currently empty. Below the table, there are several input fields and controls:

- Name:** Input field with a maximum length of 21 digits.
- FTP Server:** Input field with a 'Test' button next to it.
- FTP Login Name:** Input field with a maximum length of 21 digits.
- FTP Login Password:** Input field with a maximum length of 21 digits.
- FTP Port:** Input field with the value '21' and a range of '1 ~ 65535'.
- FTP Path:** Input field with a maximum length of 64 digits.
- FTP Passive Mode:** Radio buttons for 'Disable' and 'Enable'.

**Name:** User can specify multiple FTP paths as wish. Therefore, user needs to specify a name for each FTP setting.

**FTP Server:** Type the server name or the IP address of the FTP server.

**Test:** Check the FTP server whether this account is available or not.

**FTP Login name:** Type the user name for the FTP server.

**FTP Login Password:** Type the password for the FTP server.

**FTP Port:** Set port number of FTP service.

**FTP Path:** Set working directory path of FTP server.

**FTP Passive Mode:** Select passive or active mode connecting to FTP server.

### 3.13.2 TCP Server

In addition to send video file to FTP server, the device also can send event message to specified TCP server.

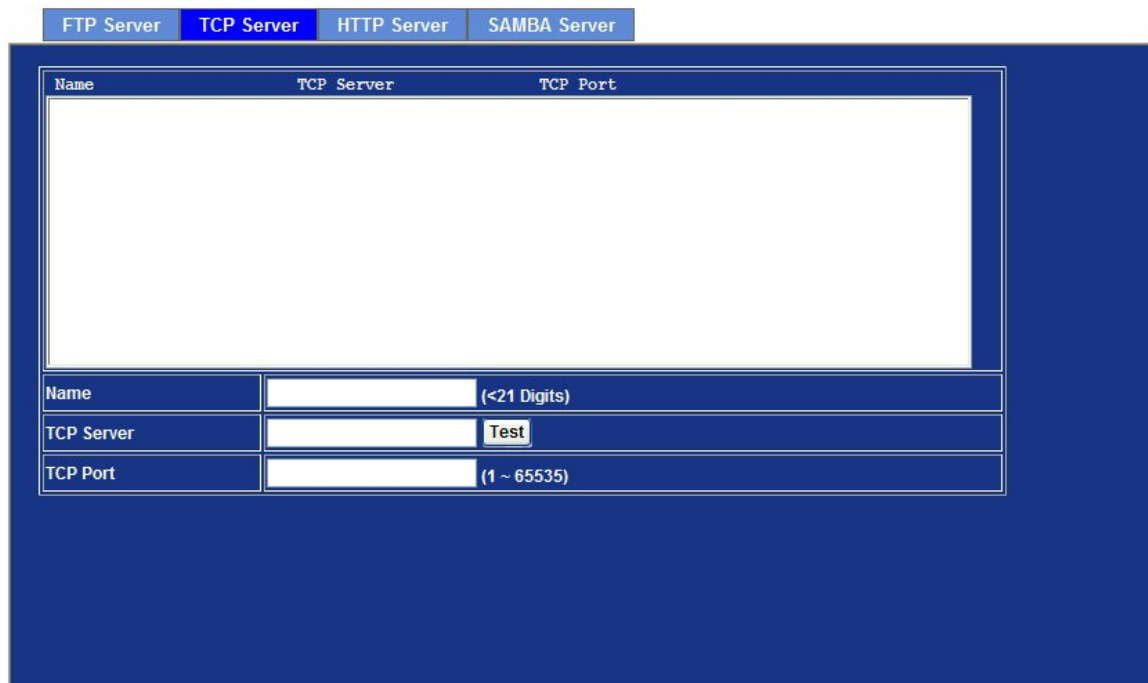

Name	TCP Server	TCP Port
------	------------	----------

Name  (<21 Digits)

TCP Server

TCP Port  (1 ~ 65535)

**Name:** User can specify multiple TCP servers as wish. Therefore, user needs to specify a name for each TCP server setting.

**TCP Server:** Type the server name or the IP address of the TCP server.

**TCP Port** Set port number of TCP server.

### 3.13.3 HTTP Server

The device also can send event message to specified HTTP server.

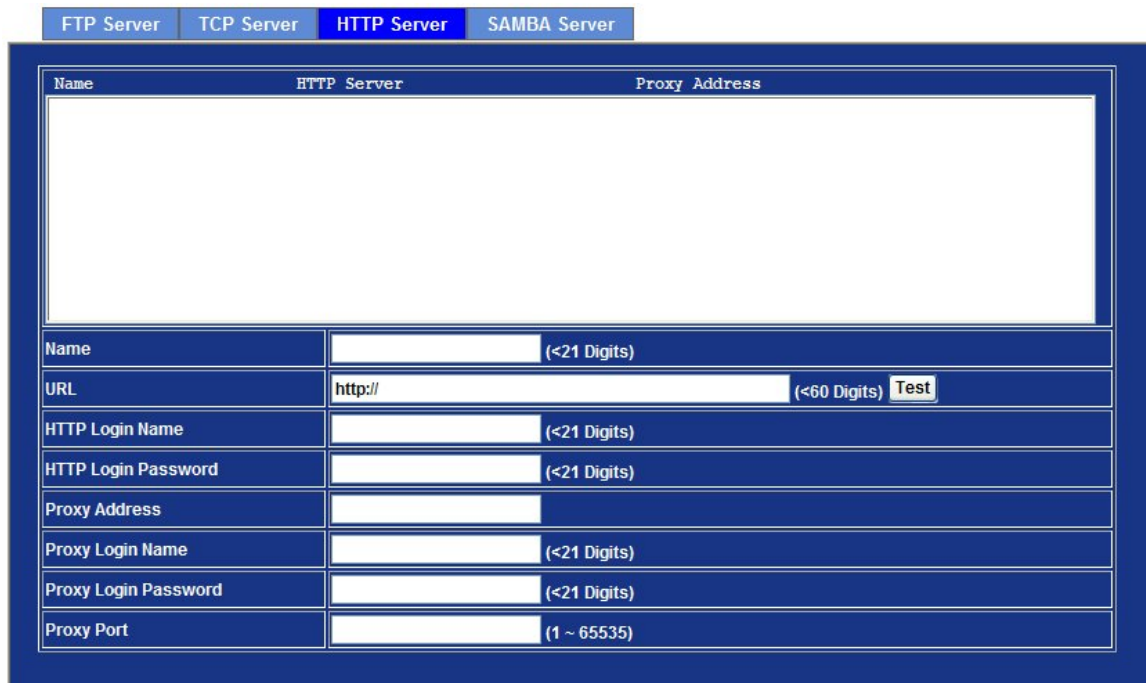

Name	Proxy Address
------	---------------

Name	<input type="text"/> (<21 Digits)
URL	<input type="text" value="http://"/> (<60 Digits) <input type="button" value="Test"/>
HTTP Login Name	<input type="text"/> (<21 Digits)
HTTP Login Password	<input type="text"/> (<21 Digits)
Proxy Address	<input type="text"/>
Proxy Login Name	<input type="text"/> (<21 Digits)
Proxy Login Password	<input type="text"/> (<21 Digits)
Proxy Port	<input type="text"/> (1 ~ 65535)

**Name:** User can specify multiple HTTP servers as wish. Therefore, user needs to specify a name for each HTTP server setting.

**URL:** Type the server name or the IP address of the HTTP server.

**Test:** Check the HTTP server whether it is available or not.

**HTTP Login name:** Type the user name for the HTTP server.

**HTTP Login Password:** Type the password for the HTTP server.

**Proxy Address:** Type the server name or the IP address of the HTTP Proxy.

**Proxy Login name:** Type the user name for the HTTP Proxy.

**Proxy Login Password:** Type the password for the HTTP Proxy.

**Proxy Port:** Set port number of Proxy.

### 3.13.4 SAMBA Server

The device also can send video stream to specified SAMBA server. Most of the time, the SAMBA server will be another PC or NAS server.

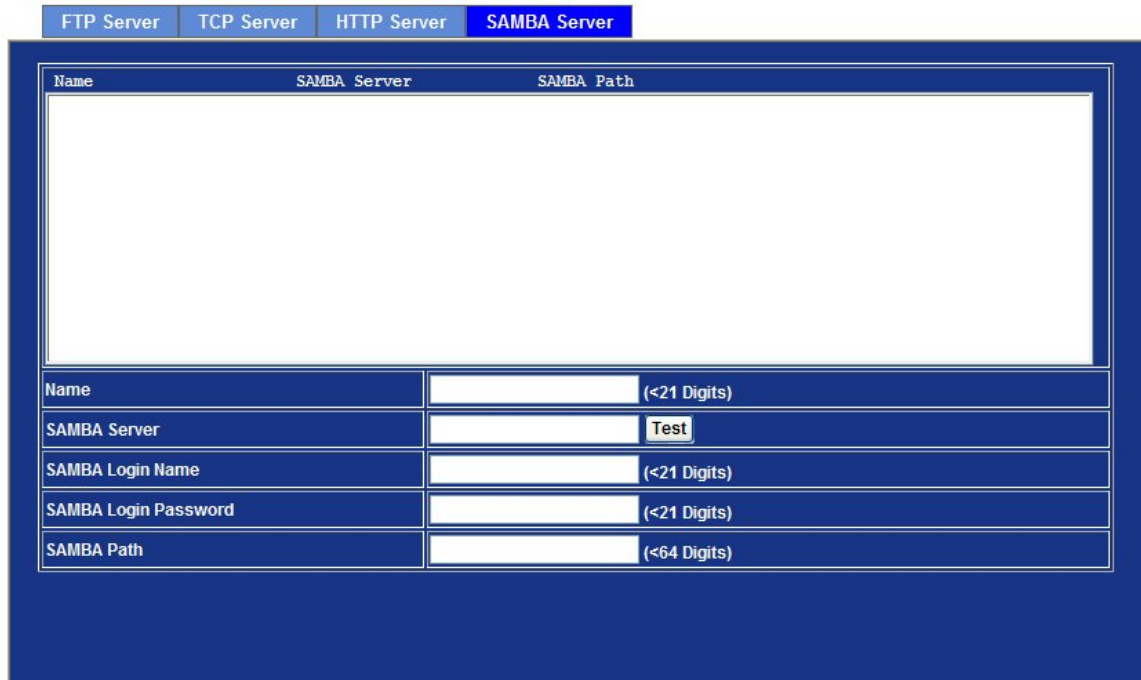

Name	SAMBA Server	SAMBA Path
------	--------------	------------

Name	<input type="text"/>	(<21 Digits)
SAMBA Server	<input type="text"/>	<input type="button" value="Test"/>
SAMBA Login Name	<input type="text"/>	(<21 Digits)
SAMBA Login Password	<input type="text"/>	(<21 Digits)
SAMBA Path	<input type="text"/>	(<64 Digits)

**Name:** User can specify multiple HTTP servers as wish. Therefore, user needs to specify a name for each HTTP server setting.

**SAMBA Server:** Type the server name or the IP address of the SAMBA server.

**Test:** Check the SAMBA server whether this account is available or not.

**SAMBA Login name:** Type the user name for the SAMBA server.

**SAMBA Login Password:** Type the password for the SAMBA server.

**SAMBA Path:** Set working directory path of SAMBA server.

### 3.14 Event Schedule Configuration

This menu is used to specify the schedule of Events and activate the some actions provided by this device.

Name	Enable	Type	Weekday	Start	Duration	Trigger by	Action																																																
<table border="1"> <tr> <td>Name</td> <td colspan="7"><input type="text"/></td> </tr> <tr> <td>Enable</td> <td colspan="7"> <input checked="" type="radio"/> Yes <input type="radio"/> No                 </td> </tr> <tr> <td>Type</td> <td colspan="7"> <input checked="" type="radio"/> Event Trigger <input type="radio"/> Schedule Trigger, Interval <input type="text" value="1"/> ( Minute)                 </td> </tr> <tr> <td>Enable Time</td> <td colspan="7"> <input checked="" type="checkbox"/> Sun <input checked="" type="checkbox"/> Mon <input checked="" type="checkbox"/> Tue <input checked="" type="checkbox"/> Wed <input checked="" type="checkbox"/> Thu <input checked="" type="checkbox"/> Fri <input checked="" type="checkbox"/> Sat                      Start from <input type="text" value="0"/> : <input type="text" value="0"/> , Duration <input type="text" value="24"/> : <input type="text" value="0"/> ( max 168:00 hours )                 </td> </tr> <tr> <td>Trigger by</td> <td colspan="7"> <input type="checkbox"/> Sensor <input type="text" value="Active"/> <input type="checkbox"/> Motion Area <input type="text" value=""/> </td> </tr> <tr> <td>Action</td> <td colspan="7"> <input type="checkbox"/> Go <input checked="" type="radio"/> Preset <input type="text" value=""/> <input type="checkbox"/> Tour <input type="text" value=""/>  <input type="checkbox"/> Voice Alert, Duration <input type="text" value="5"/> ( Seconds )  <input type="checkbox"/> Alarm Out, Duration <input type="text" value="5"/> ( Seconds )  <input type="checkbox"/> Send FTP <input type="text" value=""/>  <input type="checkbox"/> Send TCP <input type="text" value=""/>  <input type="checkbox"/> Send HTTP <input type="text" value=""/>  <input type="checkbox"/> Send E-Mail  <input type="checkbox"/> Send Samba <input type="text" value=""/> </td> </tr> </table>								Name	<input type="text"/>							Enable	<input checked="" type="radio"/> Yes <input type="radio"/> No							Type	<input checked="" type="radio"/> Event Trigger <input type="radio"/> Schedule Trigger, Interval <input type="text" value="1"/> ( Minute)							Enable Time	<input checked="" type="checkbox"/> Sun <input checked="" type="checkbox"/> Mon <input checked="" type="checkbox"/> Tue <input checked="" type="checkbox"/> Wed <input checked="" type="checkbox"/> Thu <input checked="" type="checkbox"/> Fri <input checked="" type="checkbox"/> Sat Start from <input type="text" value="0"/> : <input type="text" value="0"/> , Duration <input type="text" value="24"/> : <input type="text" value="0"/> ( max 168:00 hours )							Trigger by	<input type="checkbox"/> Sensor <input type="text" value="Active"/> <input type="checkbox"/> Motion Area <input type="text" value=""/>							Action	<input type="checkbox"/> Go <input checked="" type="radio"/> Preset <input type="text" value=""/> <input type="checkbox"/> Tour <input type="text" value=""/> <input type="checkbox"/> Voice Alert, Duration <input type="text" value="5"/> ( Seconds ) <input type="checkbox"/> Alarm Out, Duration <input type="text" value="5"/> ( Seconds ) <input type="checkbox"/> Send FTP <input type="text" value=""/> <input type="checkbox"/> Send TCP <input type="text" value=""/> <input type="checkbox"/> Send HTTP <input type="text" value=""/> <input type="checkbox"/> Send E-Mail <input type="checkbox"/> Send Samba <input type="text" value=""/>						
Name	<input type="text"/>																																																						
Enable	<input checked="" type="radio"/> Yes <input type="radio"/> No																																																						
Type	<input checked="" type="radio"/> Event Trigger <input type="radio"/> Schedule Trigger, Interval <input type="text" value="1"/> ( Minute)																																																						
Enable Time	<input checked="" type="checkbox"/> Sun <input checked="" type="checkbox"/> Mon <input checked="" type="checkbox"/> Tue <input checked="" type="checkbox"/> Wed <input checked="" type="checkbox"/> Thu <input checked="" type="checkbox"/> Fri <input checked="" type="checkbox"/> Sat Start from <input type="text" value="0"/> : <input type="text" value="0"/> , Duration <input type="text" value="24"/> : <input type="text" value="0"/> ( max 168:00 hours )																																																						
Trigger by	<input type="checkbox"/> Sensor <input type="text" value="Active"/> <input type="checkbox"/> Motion Area <input type="text" value=""/>																																																						
Action	<input type="checkbox"/> Go <input checked="" type="radio"/> Preset <input type="text" value=""/> <input type="checkbox"/> Tour <input type="text" value=""/> <input type="checkbox"/> Voice Alert, Duration <input type="text" value="5"/> ( Seconds ) <input type="checkbox"/> Alarm Out, Duration <input type="text" value="5"/> ( Seconds ) <input type="checkbox"/> Send FTP <input type="text" value=""/> <input type="checkbox"/> Send TCP <input type="text" value=""/> <input type="checkbox"/> Send HTTP <input type="text" value=""/> <input type="checkbox"/> Send E-Mail <input type="checkbox"/> Send Samba <input type="text" value=""/>																																																						

**Name:** Name of the Event or Schedule.

**Enable:** Enable or disable this Event or Schedule.

**Type:** Schedule start with Event trigger or Schedule trigger.

**Enable Time:** Define the feasible time slot.

**Trigger by:** Select the triggered sources with event trigger.

**Action:** Define the actions once event triggered.

### Example1.

Setting		Record					
Name	Enable	Type	Weekday	Start	Duration	Trigger by	Action
Send_to FTP	yes	Event	1111111	0:0	24:0	x,x	FTP

Name	Send_to FTP
Enable	<input checked="" type="radio"/> Yes <input type="radio"/> No
Type	<input checked="" type="radio"/> Event Trigger <input type="radio"/> Schedule Trigger, Interval <input type="text" value="1"/> ( Minute)
Enable Time	<input checked="" type="checkbox"/> Sun <input checked="" type="checkbox"/> Mon <input checked="" type="checkbox"/> Tue <input checked="" type="checkbox"/> Wed <input checked="" type="checkbox"/> Thu <input checked="" type="checkbox"/> Fri <input checked="" type="checkbox"/> Sat Start from <input type="text" value="0"/> : <input type="text" value="0"/> , Duration <input type="text" value="24"/> : <input type="text" value="0"/> ( max 168:00 hours )
Trigger by	<input type="checkbox"/> Sensor <input type="text" value="Active"/> <input type="checkbox"/> Motion Area <input type="text" value=""/>
Action	<input type="checkbox"/> Go <input checked="" type="radio"/> Preset <input type="radio"/> Tour <input type="checkbox"/> Voice Alert, Duration <input type="text" value=""/> ( Seconds ) <input type="checkbox"/> Alarm Out, Duration <input type="text" value=""/> ( Seconds ) <input checked="" type="checkbox"/> Send FTP <input type="text" value="Internet FTP"/> <input type="checkbox"/> Send TCP <input type="text" value=""/> <input type="checkbox"/> Send HTTP <input type="text" value=""/> <input type="checkbox"/> Send E-Mail <input type="checkbox"/> Send Samba <input type="text" value=""/>

Send file to FTP server by motion triggered always:

1. Select event trigger
2. Enable time: start from 00:00 to 24:00 every day
3. Trigger by: Motion Area (Added in Object Detection page)
4. Action : Send FTP (Add in Event Server -> FTP Server page)

## Example2.

The screenshot shows a software interface with two tabs: 'Setting' and 'Record'. The 'Setting' tab is active. At the top, there is a table with columns: Name, Enable, Type, Weekday, Start, Duration, Trigger by, and Action. The table contains one row: 'Send\_to\_email', 'yes', 'Event', '111111', '0:0', '24:0', 'xx,x', and 'SMTP'. Below the table is a configuration form for the 'Send\_to\_email' event. The form has the following fields:

- Name: Send\_to\_email
- Enable:  Yes  No
- Type:  Event Trigger  Schedule Trigger, Interval 1 (Minute)
- Enable Time:  Sun  Mon  Tue  Wed  Thu  Fri  Sat. Start from 0, Duration 24 (max 168:00 hours)
- Trigger by:  Motion Area
- Action:  Go  Preset  Tour.  Voice Alert, Duration (Seconds).  Send FTP Internet\_FTP.  Send TCP.  Send HTTP.  Send E-Mail. To email address kaceic@gmail.com

Send file to E-Mail server by motion triggered from Friday 18:00 to Saturday 06:00

1. Select event trigger.
2. Enable time: start from Friday 18:00 and keep work in 12 hours, so it will stop on Saturday 06:00.
3. Trigger by : Motion Area (Added in Object Detection page)
4. Action : Send e-mail (Add in E-Mail page)
  - i. To email address: You need to input the receiver email address.
  - ii. Subject: You could specify the email subject.
  - iii. Message: You could specify the email content.

### Example3.

The screenshot shows a software interface with two tabs: 'Setting' and 'Record'. Below the tabs is a table with columns: Name, Enable, Type, Weekday, Start, Duration, Trigger by, and Action. The table contains one entry: 'Trigger Voice Al...no', 'Schedule', '111111', '18:0', '6:0', 'x,M0', and 'VOICE'. Below the table are several configuration fields:

- Name:** Trigger\_Voice\_Alert
- Enable:**  Yes  No
- Type:**  Event Trigger  Schedule Trigger, Interval  (Minute)
- Enable Time:**  Sun  Mon  Tue  Wed  Thu  Fri  Sat  
Start from   , Duration   ( max 168:00 hours )
- Trigger by:**  Sensor   Motion Area
- Action:**  Go  Preset  Tour  
 Voice Alert, Duration  ( Seconds )  
 Alarm Out, Duration  ( Seconds )  
 Send FTP  Send TCP  Send HTTP  Send E-Mail  Send Samba

Send file to E-Mail server by motion triggered from Friday 18:00 to 24:00 from Monday to Friday.

1. Type: Select schedule trigger and interval is 10-minute.
2. Enable Time: Select Monday to Friday, and set start time from 18:00 and keep work in 6 hours.
3. Trigger by: You do not need to choose it, because this will be triggered every minute.
4. Action: Voice Alert.

## 3.15 Record Configuration

User can choose the type of record file for event or schedule application.

Setting Record

Record File Type  AVI  JPEG

Record File Prefix  (0 ~ 20 Digits)

JPEG Picture Numbers  Auto  One

**Record File Type:** Choose AVI or JPEG file format for record file.

**Record File Prefix:** Define the prefix of recorded filename.

**JPEG Picture Numbers** Define the picture capture method. "Auto" will send all the pictures from the buffer. "One" will send the first picture from the buffer.

# Appendix A: Alarm I/O Connector

Some features of the Camera can be activated by the external sensor that senses physical changes in the area Camera is monitoring. These changes can include intrusion detection or certain physical change in the monitored area. For examples, the external sensor can be a door switch or an infrared motion detector. These devices are customer provided, and are available from dealers who carry surveillance and security products. Electrically, they must be able to provide a momentary contact closure.

This Camera provides wires for general I/O terminal and RS-485 interface as below:

Cable for I/O connectors:

Name	Cable Color	Function
12VDC	Brown/White	DC 12V (50mA maximum)
GND	Blue/White	GND
D+	Purple/White	RS-485 data +
D-	Gray	RS-485 data -
DI	Green/White	Digital signal input
DO	Orange/White	Digital signal output

User can refer to the schematic below to make a proper connection between I/O connector and external sensor and output device.

## Explanation of External I/O Circuit Diagram:

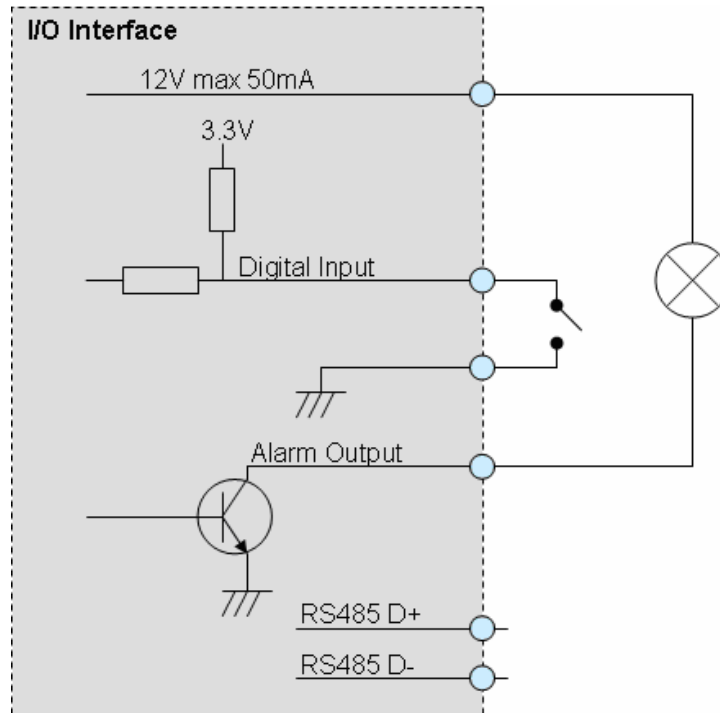

**CAUTION!**

- ✓ The low voltage/current circuits and high voltage/current circuits are in the network camera circuit. The qualified electrician should do the wiring not by yourself incorrect wiring could damage network camera. You could receive the fatal electric shock.
- ✓ The external I/O is not capable of connecting directly to devices that require large amounts of current. In some cases, a custom interface circuit (customer provided) may have to be used. Serious damage to network camera may result if a device is connected to the external I/O that exceeds its electrical capability.

## Appendix B: PING IP Address

The PING (stands for Packet Internet Groper) command is used to detect whether a specific IP address is accessible by sending a packet to the specific address and waiting for a reply. It's also a very useful tool to confirm Internet camera installed or if the IP address conflicts with any other devices over the network.

If you want to make sure the IP address of Internet camera, utilize the PING command as follows:

- Start a DOS window.
- Type ping x.x.x.x, where x.x.x.x is the IP address of the Internet camera.

The replies, as illustrated below, will provide an explanation to the problem.

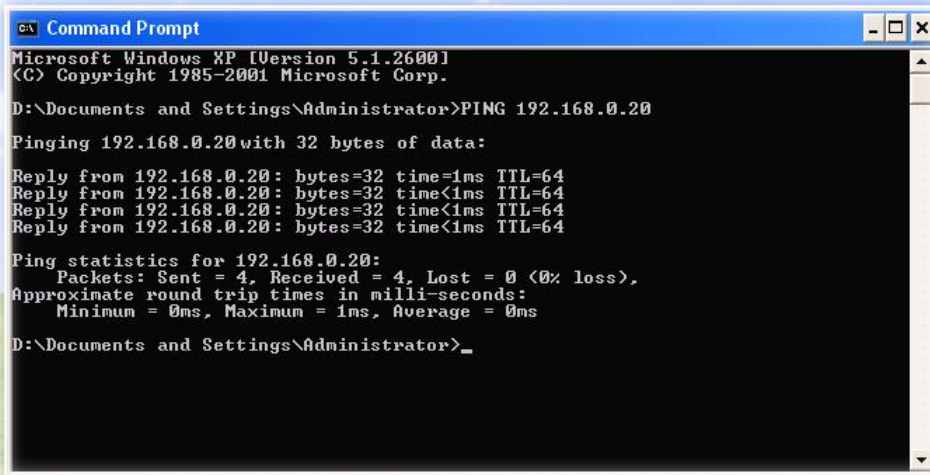

```
ca Command Prompt
Microsoft Windows XP [Version 5.1.2600]
(C) Copyright 1985-2001 Microsoft Corp.

D:\Documents and Settings\Administrator>PING 192.168.0.20

Pinging 192.168.0.20 with 32 bytes of data:

Reply from 192.168.0.20: bytes=32 time=1ms TTL=64
Reply from 192.168.0.20: bytes=32 time<1ms TTL=64
Reply from 192.168.0.20: bytes=32 time<1ms TTL=64
Reply from 192.168.0.20: bytes=32 time<1ms TTL=64

Ping statistics for 192.168.0.20:
    Packets: Sent = 4, Received = 4, Lost = 0 (0% loss),
    Approximate round trip times in milli-seconds:
        Minimum = 0ms, Maximum = 1ms, Average = 0ms

D:\Documents and Settings\Administrator>_
```

If you want to detect any other devices conflicts with the IP address of Internet camera, also can utilize the PING command but you must disconnect the Internet camera from the network first.

# Appendix C: 3GPP Access

To use the 3GPP function, in addition to previous section, you might need more information or configuration to make this function work.

<b>Note:</b>	That to use the 3GPP function, it strongly recommends to install the Networked Device with a public and fixed IP address without any firewall protection.
--------------	---

### RTSP Port:

Port 554 is the default for RTSP service. However, sometimes, some service providers change this port number for some reasons. If so, user needs to change this port accordingly.

### Dialing procedure:

1. Choose a verified player (PacketVideo or Realplayer currently)
2. Use the following URL to access:

**rtsp://host/mpeg4/media.3gp**

Where *host* is the host name or IP address of the camera.

### Compatible 3G mobile phone:

Please contact your dealer to get the approved list of compatible 3G phone.

<b>Note:</b>	Besides IP camera and 3G mobile phone. You will also need to make sure the ISP and company has provided the 3GPP service to you.
--------------	--

## Appendix D: Bandwidth and Video Size Estimation

The frame rate of video transmitted from the Internet camera depends on connection bandwidth between client and server, video resolution, codec type, and quality setting of server. Here is a guideline to help you roughly estimate the bandwidth requirements for your Internet camera.

The required bandwidth depends on content of video source. The slow motion video will produce smaller bit rate generally and fast motion will produce higher bit rate vice versa. Actual results generated by the Internet camera may be varying.

Image Resolution	Average range of data sizes for M-JPEG mode	Average bit rate for MPEG-4 mode	Average bit rate for H.264 mode
160 x 120 (QQVGA)	3 ~ 6k byte per frame	64kbps~256kbps @ 30fps	32kbps~192kbps @ 30fps
320 x 240 (QVGA)	8 ~ 20k byte per frame	256kbps~768kbps @ 30fps	192kbps~512kbps @ 30fps
640 x 480 (VGA)	20 ~ 50K byte per frame	512kbps~2048kbps @ 30fps	384kbps~1536kbps @ 30fps
1280x1024 (SXGA)	100 ~ 200k byte per frame	NA	512kbps~3076kbps @ 15fps

---

**NOTE:** Audio streaming also takes bandwidth around 5 kbps to 64kbps. Most xDSL/Cable modem upload speeds may not even reach up to 128 kbps. Thus, you may not be able to receive any video while streaming audio on a 128 kbps or lower connection. Even though the upload speed is more than 128kbps, for optimal video performance, disabling audio streaming will get better video performance.

---

# Appendix E: DDNS Application

## 1. Preface

If you have a Cable modem or xDSL, this is a great way to host your own Networked Device or other TCP/IP Service. Get your own domain like www.yourname.com, www.yourname.com.tw etc. (Note: This domain must be registered with Internic via registration authorities such as Network Solutions, DirectNIC, Register.com etc). Your domain name's dynamic IP address is automatically tracked by a DDNS server.

Host your own Networked Device and much more no matter what your computer's IP address may be and even if you have dialup, DSL or cable modem internet connection where your computer's IP address changes all the time!! DDNS service supports all top level domain names including but not limited to .com, .net, .org, .to, .uk etc.

## 2. Ethernet Network Environment

Normally, DDNS service is only necessary for the users that could only obtain dynamic IP addresses. As to the users that could obtain the static valid IP address, they do not usually have to apply the DDNS service. Before we decide if DDNS is necessary for the users, we have to check what kind of Ethernet network environment we have to install our Networked Device on.

### (1) Environment of Fixed Valid IP Network

If users could obtain valid IP addresses, they could save the effort to apply DDNS service. Because the IP address in this environment is fixed, users could input the IP address or domain name of demo site directly in the IE browser.

### (2) Environment of Dynamic IP Network

If users is under an environment of dynamic IP network (Dial-up xDSL), they have to apply a domain name in advance. Then apply DDNS service. Finally setup the necessary information of DDNS and PPPoE of the Networked Device in order to let the outside administrator be able to access through internet.

## 3. Application Steps – DDNS & Domain Name

(1). Visit the following web site: <http://www.dyndns.org/>

(2). Click “Account”



(3). After the columns show up at the left side, click “Create Account”.

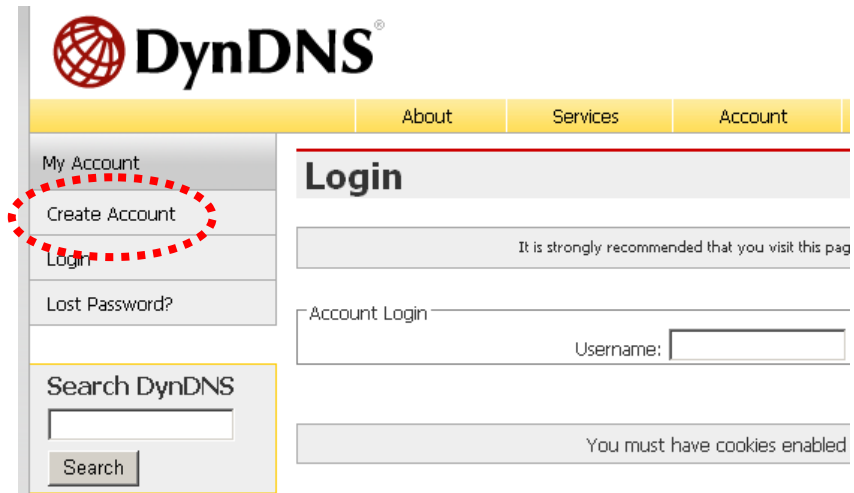

(4). Fill the application agreement and necessary information.

- a. Username
- b. E-mail address and confirmation
- c. Password and confirmation
- d. Submit all the input information and finish creating an account

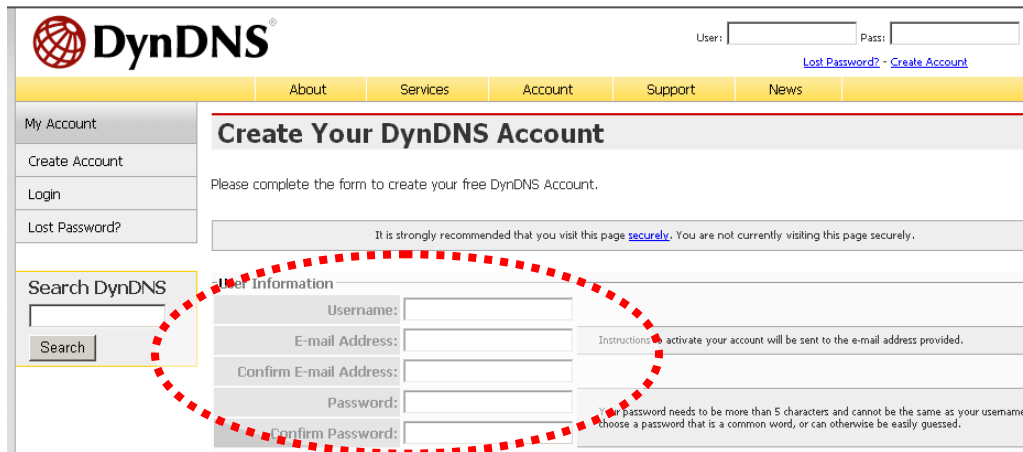

## Terms of Service

Please read the acceptable use policy (AUP) and accept it prior to creating your account. Also acknowledge that you may only have one (1) free account, and that creation of multiple free accounts will result in the deletion of all of your accounts.

Policy Last Modified: February 6, 2006

1. ACKNOWLEDGMENT AND ACCEPTANCE OF TERMS OF SERVICE

All services provided by Dynamic Network Services, Inc. ("DynDNS") are provided to you (the "Member") under the Terms and Conditions set forth in this Acceptable Use Policy ("AUP") and any other operating rules and policies set forth by DynDNS. The AUP comprises the entire agreement between the Member and DynDNS and supersedes all prior agreements between the parties regarding the subject matter contained herein. BY COMPLETING THE REGISTRATION PROCESS AND CLICKING THE "Accept" BUTTON, YOU ARE INDICATING YOUR AGREEMENT TO BE BOUND BY ALL OF THE TERMS AND CONDITIONS OF THE AUP.

2. DESCRIPTION OF SERVICE

I agree to the AUP:

I will only create one (1) free account:

Click these two options

## Next Step

After you click "Create Account", we will create your account and send you an e-mail to the address you provided. Please follow the instructions in that e-mail to confirm your account. You will need to confirm your account within 48 hours or we will automatically delete your account. (This helps prevent unwanted robots on our systems)

Create Account

- (5). Check your e-mail mailbox. There will be an e-mail with a title "Your DynDNS Account Information". Click the hyperlink address to confirm the DDNS service that you just applied. Then DDNS you applied activated.

Click to confirm

Your DynDNS Account 'kkkkk' has been created. You need to visit the confirmation address below within 48 hours to complete the account creation process:

[https://www.dyndns.com/account/confirm/oDDGDYN75qTJk\\_ICGba6vQ](https://www.dyndns.com/account/confirm/oDDGDYN75qTJk_ICGba6vQ)

Our basic service offerings are free, but they are supported by our paid services. See <http://www.dyndns.com/services/> for a full listing of all of our available services.

If you did not sign up for this account, this will be the only communication you will receive. All non-confirmed accounts are automatically deleted after 48 hours, and no addresses are kept on file. We apologize for any inconvenience this correspondence may have caused, and we assure you that it was only sent at the request of someone visiting our site requesting an account.

Sincerely,  
The DynDNS Team

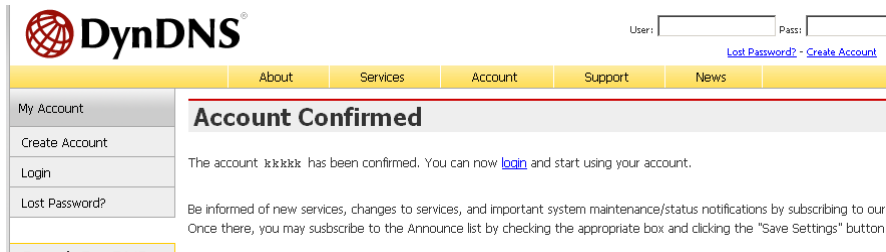

- (6). Enter the web page <http://www.dyndns.org/> again. Input your username and password that you just applied to login administration interface of DDNS server.



- (7). If the correct username and password are input, you can see the following picture at the top-right of the login page.

- (8). Click the "Services".



(9). Click the “ [Dynamic DNS](#) ”.

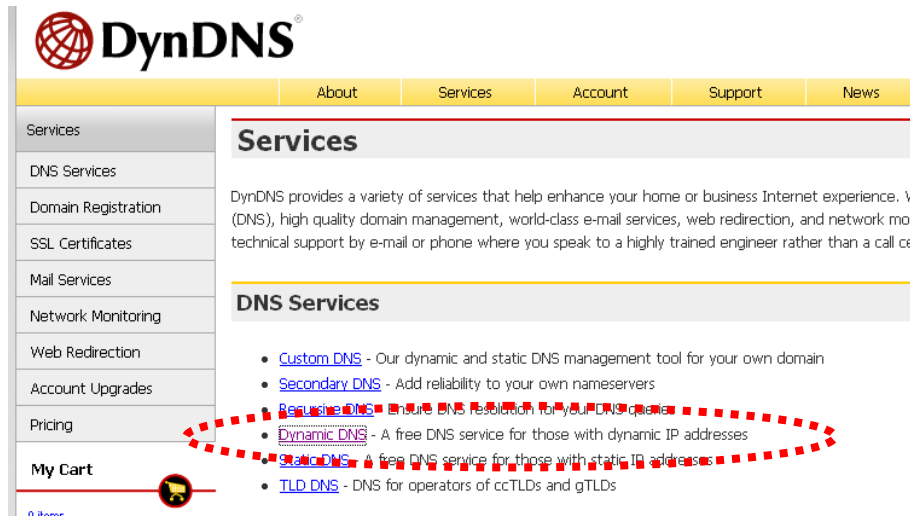

(10). Click the “ [Create Hosts](#) ”.

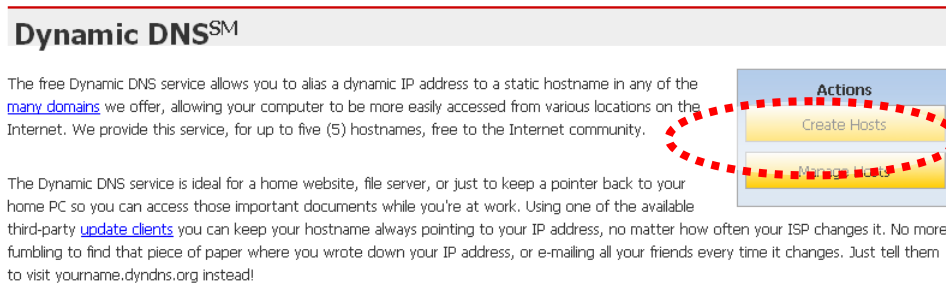

(11). We could create a domain name without any charge at this step. First, we input the host name. (No.1) Then we pick a domain that is easy to remember. Finally (No.2), click the “Add Host” to submit the domain name information. (No.3)

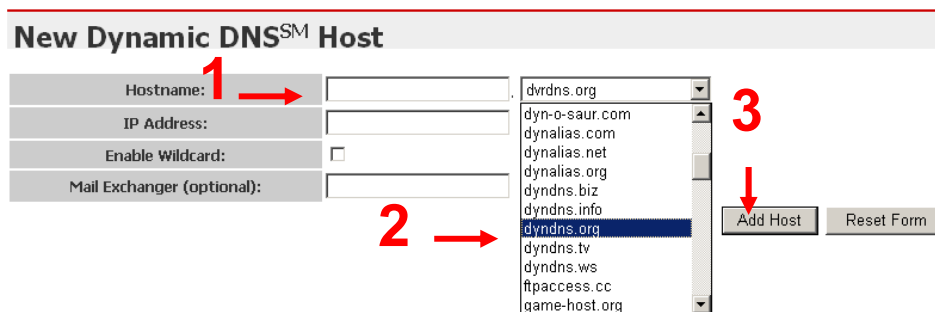

#### 4. Setup the DDNS and PPPoE of Network Device

At last, users have to enter the web page of Networked Device and setup the necessary information of DDNS and PPPoE after the application of DDNS service. Please check the user manual to access the DDNS and PPPoE pages. After saving the modification, restart the device. The external users could browse the Networked Device by the input of their domain name.

# Appendix F:

## Configure Port Forwarding Manually

The device can be used with a router. If the device wants to be accessed from the WAN, its IP address needs to be setup as fixed IP address, also the port forwarding or Virtual Server function of router needs to be setup. This device supports UPnP traversal function. Therefore, user could use this feature to configure port forwarding of NAT router first. However, if user needs to configure port forwarding manually, please follow the steps as below:

Manually installing the device with a router on your network is an easy 3–step procedure as following:

1. Assign a local/fixed IP address to your device
2. Access the Router with Your Web browser
3. Open/Configure Virtual Server Ports of Your Router

### 1. Assign a local/fixed IP address to your device

The device must be assigned a local and fixed IP Address that allows it to be recognized by the router. Manually setup the device with a fixed IP address, for example, *192.168.0.100*.

### 2. Access the Router with Your Web browser

The following steps generally apply to any router that you have on your network. The PLANET WNRT-620 is used as an example to clarify the configuration process. Configure the initial settings of the router by following the steps outlined in the router's **Quick Installation Guide**.

If you have cable or DSL service, you will most likely have a dynamically assigned WAN IP Address. 'Dynamic' means that your router's WAN IP address can change from time to time depending on your ISP. A dynamic WAN IP Address identifies your router on the public network and allows it to access the Internet. To find out what your router's WAN IP Address is, go to the **Status** screen on your router and locate the WAN information for your router. As shown on the following page the WAN IP Address will be listed. This will be the address that you will need to type in your web browser to view your camera over the Internet. Be sure to uncheck the **Reset IP address at next boot** button at the top of the screen after modifying the IP address. Failure to do so will reset the IP address when you restart your computer.

PLANET Networking & Communication

Home | General Setup | Status | Tool

Internet Broadband Router

**Status**

- Internet Connection
- Device Status
- System Log
- Security Log
- Active DHCP Client
- Statistics

Current Time  
1/1/2000 2:01:15

**Internet Connection** ⓘ

View the current internet connection status and related information.

Attain IP Protocol :	Dynamic IP disconnect
IP Address :	
Subnet Mask :	
Default Gateway :	0.0.0.0
MAC Address :	00:11:22:33:44:56
Primary DNS :	
Secondary DNS :	

Your WAN IP Address will be listed here.

### 3. Open/set Virtual Server Ports to enable remote image viewing

The firewall security features built into the router and most routers prevent users from accessing the video from the device over the Internet. The router connects to the Internet over a series of numbered ports. The ports normally used by the device are blocked from access over the Internet. Therefore, these ports need to be made accessible over the Internet. This is accomplished using the **Virtual Server** function on the router. The Virtual Server ports used by the camera must be opened through the router for remote access to your camera.

Follow these steps to configure your router's Virtual Server settings

- Click **Enabled**.
- Enter a unique name for each entry.
- Select **Both** under **Protocol Type (TCP and UDP)**
- Enter your camera's local IP Address (e.g., **192.168.0.100**, for example) in the **Private IP** field.
- If you are using the default camera port settings, enter **80** into the **Public and Private Port** section, click **Add**.

A check mark appearing before the entry name will indicate that the ports are enabled.

**NOTE:** Some ISPs block access to port 80. Be sure to check with your ISP so that you can open the appropriate ports accordingly. If your ISP does not pass traffic on port 80, you will need to change the port the camera uses from 80 to something else, such as 8080. Not all routers are the same, so refer to your user manual for specific instructions on how to open ports.

The screenshot shows the 'Virtual Server' configuration page on a Planet Internet Broadband Router. The page has a dark blue header with the Planet logo and navigation links: Home, General Setup, Status, and Tool. The main title is 'Internet Broadband Router'. On the left, a sidebar menu lists various settings: System, WAN, LAN, Wireless, QoS, NAT (selected), and Firewall. Under NAT, there are sub-options: Port Forwarding, Virtual Server (highlighted), Special applications, UPnP Setting, and ALG Settings. The main content area is titled 'Virtual Server' and contains a checkbox for 'Enable Virtual Server' which is checked. Below this is a form with columns for Private IP, Private Port, Type, Public Port, WAN Port, and Comment. The form has input fields and dropdown menus for each column. Below the form are 'Add' and 'Reset' buttons. A section titled 'Current Virtual Server Table' contains a table with columns: Private IP, Private Port, Type, Public Port, WAN Port, Comment, and Select. The table has one row with the following data: Private IP: 192.168.0.100, Private Port: 80, Type: TCP+UDP, Public Port: 80, WAN Port: WAN1, Comment: ICA-HM230, and a checked 'Select' checkbox. Below the table are 'Delete Selected', 'Delete All', and 'Reset' buttons. At the bottom right of the page are 'Apply' and 'Cancel' buttons.

Virtual Server

You can configure the Broadband router as a Virtual Server so that remote users accessing services such as the Web or FTP at your local site via Public IP Addresses can be automatically redirected to local servers configured with Private IP Addresses. In other words, depending on the requested service (TCP/UDP) port number, the Broadband router redirects the external service request to the appropriate internal server (located at one of your LAN's Private IP Address).

Enable Virtual Server

Private IP	Private Port	Type	Public Port	WAN Port	Comment
<input type="text"/>	<input type="text"/>	Both	<input type="text"/>	WAN1	<input type="text"/>

Add Reset

Current Virtual Server Table:

Private IP	Private Port	Type	Public Port	WAN Port	Comment	Select
192.168.0.100	80	TCP+UDP	80	WAN1	ICA-HM230	<input checked="" type="checkbox"/>

Delete Selected Delete All Reset

Apply Cancel

Enter valid ports in the **Virtual Server** section of your router. Please make sure to check the box on this line to enable settings. Then the device can be access from WAN by the router's WAN IP Address.

By now, you have finished your entire PC configuration for this device.

# Appendix G: Troubleshooting & Frequently Asked Questions

Features	
The video and audio codec is adopted in the device.	<p>The device utilizes H.264, MPEG-4 and M-JPEG triple compression to providing high quality images. Where H.264 and MPEG-4 are standards for video compression and M-JPEG is a standard for image compression.</p> <p>The audio codec is defined as AMR for 3GPP and G.711/G.726 for RTSP streaming.</p>
The maximum number of user accesses the device simultaneously.	<p>The maximum number of users is limited to 20. However, it also depends on the total bandwidth accessed to this device from clients. The maximum data throughput of the device is around 20~25Mbps for UDP mode and 10Mbps for HTTP mode. Therefore, the actual number of connected clients is varying by streaming mode, settings of resolution, codec type, frame rate and bandwidth. Obviously, the performance of the each connected client will slow down when many users are logged on.</p>
The device can be used outdoors or not.	<p>The device is not weatherproof. It needs to be equipped with a weatherproof case for outdoors using. However, equipped with a weatherproof case might disable the audio function of the device.</p>
Install this device	
Status LED does not light up.	<ul style="list-style-type: none"> <li>● Check and confirm that the DC power adaptor, included in packaged, is used. Secure the power connector and re-power it on again.</li> <li>● If the problem is not solved, the device might be faulty. Contact your dealer for further help.</li> </ul>
The network cabling is required for the device.	<p>The device uses Category 5 UTP cable allowing 10 and/or 100 Base-T networking.</p>
The device will be installed and work if a firewall exists on the network.	<p>If a firewall exists on the network, port 80 is open for ordinary data communication. The HTTP port and RTSP port need to be opened on the firewall or NAT router.</p>
The username and password for the first time or after factory default reset	<p>Username = <b>admin</b> and leave password blank.</p> <p>Note that it's all case sensitivity.</p>
Forgot the username and password	<p>Follow the steps below.</p> <ol style="list-style-type: none"> <li>1. Restore the factory default setting by press pressing and holding down more than 3 seconds on the device.</li> </ol>

	2. Reconfigure the device.
Forgot the IP address of the device.	Check IP address of device by using the PLANET IPWizard II program or by UPnP discovery or set the device to default by Reset button.
PLANET IPWizard II program cannot find the device.	<ul style="list-style-type: none"> <li>● Re-power the device if cannot find the unit within 1 minutes.</li> <li>● Do not connect device over a router. IPWizard program cannot detect device over a router.</li> <li>● If IP address is not assigned to the PC which running PLANET IPWizard II program, then PLANET IPWizard II program cannot find device. Make sure that IP address is assigned to the PC properly.</li> <li>● Antivirus software on the PC might interfere with the setup program. Disable the firewall of the antivirus software during setting up this device.</li> <li>● Check the firewall setting of your PC or Notebook.</li> </ul>
Internet Explorer does not seem to work well with the device	Make sure that your Internet Explorer is version 6.0 or later. If you are experiencing problems, try upgrading to the latest version of Microsoft's Internet Explorer from the Microsoft webpage.
PLANET IPWizard II program fails to save the network parameters.	Network may have trouble. Confirm the parameters and connections of the device.
<b>UPnP NAT Traversal</b>	
Can not work with NAT router	Maybe NAT router does not support UPnP function. Please check user's manual of router and turn on UPnP function.
Some IP cameras are working but others are failed	Maybe too many IP cameras have been installed on the LAN, and then NAT router is out of resource to support more cameras. You could turn off and on NAT router to clear out of date information inside router.
<b>Access this device</b>	
Cannot access the login page and other web pages of the Network Camera from Internet Explorer	<ul style="list-style-type: none"> <li>● Maybe the IP Address of the Network Camera is already being used by another device or computer. To confirm this possible problem, disconnect the Network Camera from the network first, and then run the PING utility to check it out.</li> <li>● Maybe due to the network cable. Try correcting your network cable and configuration. Test the network interface by connecting a local computer to the Network Camera via a crossover cable.</li> <li>● Make sure the Internet connection and setting is ok.</li> <li>● Make sure enter the IP address of Internet Explorer is correct. If the Network Camera has a dynamic address, it may have changed since you last checked it.</li> <li>● Network congestion may prevent the web page appearing</li> </ul>

	<p>quickly. Wait for a while.</p> <p>The IP address and Subnet Mask of the PC and Network Camera must be in the same class of the private IP address on the LAN.</p> <ul style="list-style-type: none"> <li>● Make sure the http port used by the Network Camera, default=80, is forward to the Network Camera's private IP address.</li> <li>● The port number assigned in your Network Camera might not be available via Internet. Check your ISP for available port.</li> <li>● The proxy server may prevent you from connecting directly to the Network Camera, set up not to use the proxy server.</li> <li>● Confirm that Default Gateway address is correct.</li> <li>● The router needs Port Forwarding feature. Refer to your router's manual for details.</li> <li>● Packet Filtering of the router may prohibit access from an external network. Refer to your router's manual for details.</li> <li>● Access the Network Camera from the Internet with the global IP address of the router and port number of Network Camera.</li> <li>● Some routers reject the global IP address to access the Network Camera on the same LAN. Access with the private IP address and correct port number of Network Camera.</li> <li>● When you use DDNS, you need to set Default Gateway and DNS server address.</li> <li>● If it's not working after above procedure, reset Network Camera to default setting and installed it again.</li> </ul>
<p>Image or video does not appear in the main page.</p>	<ul style="list-style-type: none"> <li>● The first time the PC connects to Network Camera, a pop-up <b>Security Warning</b> window will appear to download ActiveX Controls. When using Windows XP, or Vista, log on with an appropriate account that is authorized to install applications.</li> <li>● Network congestion may prevent the Image screen from appearing quickly. You may choose lower resolution to reduce the required bandwidth.</li> </ul>
<p>How to check the device's ActiveX is installed on your computer</p>	<p>Go to C:\Windows\Downloaded Program Files and check to see if there is an entry for the file "<b>IPCamera Control</b>". The status column should show "Installed". If the file is not listed, make sure your Security Settings in Internet Explorer are configured properly and then try reloading the device's home page. Most likely, the ActiveX control did not download and install correctly. Check your Internet Explorer security settings and then close and restart Internet Explorer. Try to browse and log in again.</p>
<p>Internet Explorer displays the following message: "Your current security settings prohibit downloading ActiveX controls".</p>	<p>Setup the IE security settings or configure the individual settings to allow downloading and scripting of ActiveX controls.</p>

<p>The device work locally but not externally.</p>	<ul style="list-style-type: none"> <li>● Might be caused from the firewall protection. Check the Internet firewall with your system or network administrator. The firewall may need to have some settings changed in order for the device to be accessible outside your LAN.</li> <li>● Make sure that the device isn't conflicting with any other web server running on your LAN.</li> <li>● Check the configuration of the router settings allow the device to be accessed outside your local LAN.</li> <li>● Check the bandwidth of Internet connection. If the Internet bandwidth is lower than target bit rate, the video streaming will not work correctly.</li> </ul>
<p>The unreadable characters are displayed.</p>	<p>Use the operating system of the selected language. Set the Encoding or the Character Set of the selected language on the Internet Explorer.</p>
<p>Frame rate is slower than the setting.</p>	<ul style="list-style-type: none"> <li>● The traffic of the network and the object of the image affect the frame rate. The network congestion causes frame rate slower than the setting.</li> <li>● Check the bandwidth of Internet connection. If the Internet bandwidth is lower than target bit rate, the video streaming will not work correctly.</li> <li>● Ethernet switching hub can smooth the frame rate.</li> </ul>
<p>Blank screen or very slow video when audio is enabled.</p>	<ul style="list-style-type: none"> <li>● Your connection to the device does not have enough bandwidth to support a higher frame rate for the streamed image size. Try reducing the video streaming size to 160x120 or 320x240 and/or disabling audio.</li> <li>● Audio will consume 32 kbps. Disable audio to improve video. Your Internet connection may not have enough bandwidth to support streaming audio from the device.</li> </ul>
<p>Image Transfer on e-mail or FTP does not work.</p>	<ul style="list-style-type: none"> <li>● Default Gateway and DNS server address should be set up correctly.</li> <li>● If FTP does not work properly, ask your ISP or network administrator about the transferring mode of FTP server.</li> </ul>
<p><b>Video quality of the device</b></p>	
<p>The focus on the Camera is bad.</p>	<p>The lens is dirty or dust is attached. Fingerprints, dust, stain, etc. on the lens can degrade the image quality.</p>
<p>The color of the image is poor or strange.</p>	<ul style="list-style-type: none"> <li>● Adjust White Balance.</li> <li>● To insure the images you are viewing are the best they can be, set the Display property setting (color quality) to 16bit at least and 24 bit or higher if possible within your computer.</li> <li>● The configuration on the device image display is incorrect. You need to adjust the image related parameters such as brightness,</li> </ul>

	contrast, hue and sharpness properly.
Image flickers.	<ul style="list-style-type: none"> <li>• Wrong power line frequency makes images flicker. Make sure the 50 or 60Hz format of your device.</li> <li>• If the object is dark, the image will flicker. Make the condition around the Camera brighter.</li> </ul>
<b>Miscellaneous</b>	
Can not play the recorded ASF file	Please installed Microsoft®'s DirectX 9.0 or later and uses the Windows Media Player 11.0 or later to play the AVI filed recorded by the Device.

# Appendix H: Product Specification

Product	ICA-HM135
<b>Video Specification</b>	
Image Sensor	1.3 Mega-Pixel CMOS image sensor
Lens	2.7-9mm Vari-Focal lens with ICR and DC Iris
Sensitivity	1.0V/lux-sec (550nm)
View Angle	H: 20-59 Degree / V: 15-46 Degree
IR LED	High light IR LED x 24pcs
IR Distance	20M
Video Encoder	H.264 / MPEG-4 / M-JPEG
Rate Control	CBR (Constant Bit Rate) / VBR (Variable Bit Rate)
Video Resolution	H.264 SXGA / VGA / QVGA / QQVGA MPEG4 VGA / QVGA / QQVGA M-JPEG SXGA / VGA / QVGA / QQVGA
Frame Rate	Mega-Pixel mode up to 15fps for all resolution VGA mode up to 30fps for VGA / QVGA / QQVGA
Image Control	AWB, AES
<b>Audio Specification</b>	
Audio Codec	G.711 / G.726 / AMR
Audio I/O	Audio in: Internal Microphone / Audio out: External Speaker
Audio Streaming	One-Way or Two-way
<b>Network and Configuration</b>	
Network Interface	1 x RJ-45
Network Standard	IEEE 802.3 / IEEE 802.3u
Network Protocol	TCP/IP, HTTP, SMTP, FTP, NTP, DNS, DDNS, DHCP, UPnP, RTSP, PPPoE, 3GPP
Browser / Software	Microsoft ® Internet Explorer 6.0 or later, Cam Viewer Plus Lite/Pro
Motion Detection	10 area definable
<b>Environment Specifications</b>	
Protection Class	IP-66 classification with Vandal and Weather proof
Power Requirement	12V DC, 1 A IEEE 802.3af
Dimension (L x Φ)	106 x 144 mm
Weight	1175 g
Power Consumption	500mA max (LED on)
Operating Temperature	-20 ~ 50 Degree C
Operating Humidity	20 ~ 80% (non-condensing)
Emission	CE, FCC

## EC Declaration of Conformity

For the following equipment:

\*Type of Product: H.264 Mega-Pixel 20M IR Vandal Proof Dome IP Camera

\*Model Number: ICA-HM135

\* Produced by:

Manufacturer's Name : **Planet Technology Corp.**  
Manufacturer's Address: 11F, No 96, Min Chuan Road,  
Hsin Tien, Taipei, Taiwan, R.O.C.

is herewith confirmed to comply with the requirements set out in the Council Directive on the Approximation of the Laws of the Member States relating to Electromagnetic Compatibility (89/336/EEC.).

For the evaluation regarding the Electromagnetic Compatibility, the following standards were applied:

EN 55022	(2006, Class B)
EN 61000-3-2	(2006)
EN 61000-3-3	(1995 + A1: 2001 + A2: 2005)
EN 55024	(1998 + A1: 2001 + A2: 2003)
IEC 61000-4-2	(2001)
IEC 61000-4-3	(2007)
IEC 61000-4-4	(2004)
IEC 61000-4-5	(2005)
IEC 61000-4-6	(2006)
IEC 61000-4-8	(2001)
IEC 61000-4-11	(2004)

Responsible for marking this declaration if the:

Manufacturer     Authorized representative established within the EU

Authorized representative established within the EU (if applicable):

Company Name: **Planet Technology Corp.**

Company Address: **11F, No. 96, Min Chuan Road, Hsin Tien, Taipei, Taiwan, R.O.C**

Person responsible for making this declaration

Name, Surname **Jonas Yang**

Position / Title : **Product Manager**

Taiwan  
Place

19<sup>th</sup> Oct., 2009  
Date

  
Legal Signature

**PLANET TECHNOLOGY CORPORATION**

e-mail: sales@planet.com.tw    http://www.planet.com.tw

11F, No. 96, Min Chuan Road, Hsin Tien, Taipei, Taiwan, R.O.C. Tel:886-2-2219-9518 Fax:886-2-2219-9528