

Configuration Guide



4-Slot Layer 3 Routing Chassis Switch

▶ XGS3-42000R



Trademarks

Copyright © PLANET Technology Corp. 2016.

Contents subject to which revision without prior notice.

PLANET is a registered trademark of PLANET Technology Corp. All other trademarks belong to their respective owners.

Disclaimer

PLANET Technology does not warrant that the hardware will work properly in all environments and applications, and makes no warranty and representation, either implied or expressed, with respect to the quality, performance, merchantability, or fitness for a particular purpose. PLANET has made every effort to ensure that this User's Manual is accurate; PLANET disclaims liability for any inaccuracies or omissions that may have occurred.

Information in this User's Manual is subject to change without notice and does not represent a commitment on the part of PLANET. PLANET assumes no responsibility for any inaccuracies that may be contained in this User's Manual. PLANET makes no commitment to update or keep current the information in this User's Manual, and reserves the right to make improvements to this User's Manual and/or to the products described in this User's Manual, at any time without notice.

If you find information in this manual that is incorrect, misleading, or incomplete, we would appreciate your comments and suggestions.

FCC Warning

This equipment has been tested and found to comply with the limits for a Class A digital device, pursuant to Part 15 of the FCC Rules. These limits are designed to provide reasonable protection against harmful interference when the equipment is operated in a commercial environment. This equipment generates, uses, and can radiate radio frequency energy and, if not installed and used in accordance with the Instruction manual, may cause harmful interference to radio communications. Operation of this equipment in a residential area is likely to cause harmful interference in which case the user will be required to correct the interference at whose own expense.

CE Mark Warning

This is a Class A product. In a domestic environment, this product may cause radio interference, in which case the user may be required to take adequate measures.

WEEE Warning



To avoid the potential effects on the environment and human health as a result of the presence of hazardous substances in electrical and electronic equipment, end users of electrical and electronic equipment should understand the meaning of the crossed-out wheeled bin symbol. Do not dispose of WEEE as unsorted municipal waste and have to collect such WEEE separately.

Revision

PLANET 4-Slot Layer 3 IPv6/IPv4 Routing Chassis Switch User's Manual

FOR MODEL: XGS3-42000R

REVISION: 2.0 (June 2016)

Part No: EM-XGS3-42000R (2081-A96040-001)

Contents

CHAPTER 1 INTRODUCTION OF XGS3-42000R	1-1
1.1 PACKET CONTENTS	1-1
1.2 PRODUCT DESCRIPTION	1-2
1.3 PRODUCT FEATURES	1-4
1.4 PRODUCT SPECIFICATIONS	1-6
1.4.1 XGS3-42000R Specification	1-6
1.4.2 Management Module Specification	1-10
1.4.3 Standard Ethernet Module Specification	1-13
CHAPTER 2 INSTALLATION	2-1
2.1 HARDWARE DESCRIPTION	2-1
2.1.1 Chassis Switch Hardware Description	2-1
2.1.2 Management Module Hardware Description.....	2-2
2.1.3 Standard Ethernet Module Hardware Description.....	2-5
2.1.4 AC Power Supply Module Hardware Description	2-7
2.2 CHASSIS SWITCH INSTALLATION	2-8
2.2.1 Desktop Installation	2-8
2.2.2 Rack Mounting	2-9
2.2.3 Chassis Switch Grounding	2-11
2.2.4 Installing the Management/Standard Ethernet Module	2-12
2.2.5 Removing/Installing the Dust Gauze.....	2-13
2.2.6 Removing/Installing the Fan Tray	2-14
2.2.7 Removing/Installing the Power Supply Unit	2-15
2.2.8 Installing the SFP/SFP+ Transceiver	2-16
CHAPTER 3 CHASSIS SWITCH MANAGEMENT	3-19
3.1 MANAGEMENT OPTIONS	3-19
3.1.1 Out-Of-Band Management.....	3-19
3.1.2 In-Band Management.....	3-22
3.2 CLI INTERFACE	3-25
3.2.1 Configuration Modes	3-26
3.2.2 Configuration Syntax.....	3-28
3.2.3 Shortcut Key Support.....	3-28
3.2.4 Help Function	3-29
3.2.5 Input Verification.....	3-30
3.2.6 Fuzzy Match Support	3-30
CHAPTER 4 BASIC CHASSIS SWITCH CONFIGURATION	4-1
4.1 BASIC CONFIGURATION	4-1
4.2 TELNET MANAGEMENT	4-2

4.2.1 Telnet.....	4-2
4.2.2 SSH.....	4-3
4.3 CONFIGURATE CHASSIS SWITCH IP ADDRESSES	4-5
4.3.1 Chassis Switch IP Addresses Configuration Task List.....	4-5
4.4 SNMP CONFIGURATION	4-6
4.4.1 Introduction to SNMP	4-6
4.4.2 Introduction to MIB	4-7
4.4.3 Introduction to RMON	4-8
4.4.4 SNMP Configuration	4-8
4.4.5 Typical SNMP Configuration Examples	4-11
4.4.6 SNMP Troubleshooting	4-12
4.5 SWITCH UPGRADE	4-13
4.5.1 Chassis Switch System Files	4-13
4.5.2 BootROM Upgrade.....	4-13
4.5.3 FTP/TFTP Upgrade.....	4-15
CHAPTER 5 FILE SYSTEM OPERATIONS.....	5-1
5.1 INTRODUCTION TO FILE STORAGE DEVICES.....	5-1
5.2 FILE SYSTEM OPERATION CONFIGURATION TASK LIST	5-1
5.3 TYPICAL APPLICATIONS.....	5-3
5.4 TROUBLESHOOTING	5-3
CHAPTER 6 CLUSTER CONFIGURATION.....	6-1
6.1 INTRODUCTION TO CLUSTER NETWORK MANAGEMENT.....	6-1
6.2 CLUSTER NETWORK MANAGEMENT CONFIGURATION SEQUENCE.....	6-1
6.3 EXAMPLES OF CLUSTER ADMINISTRATION	6-4
6.4 CLUSTER ADMINISTRATION TROUBLESHOOTING.....	6-5
CHAPTER 7 PORT CONFIGURATION.....	7-1
7.1 INTRODUCTION TO PORT	7-1
7.2 NETWORK PORT CONFIGURATION TASK LIST	7-1
7.3 PORT CONFIGURATION EXAMPLE	7-3
7.4 PORT TROUBLESHOOTING.....	7-4
CHAPTER 8 PORT ISOLATION FUNCTION CONFIGURATION	8-1
8.1 INTRODUCTION TO PORT ISOLATION FUNCTION.....	8-1
8.2 TASK SEQUENCE OF PORT ISOLATION.....	8-1
8.3 PORT ISOLATION FUNCTION TYPICAL EXAMPLES.....	8-2
CHAPTER 9 PORT LOOPBACK DETECTION FUNCTION CONFIGURATION	9-3

9.1 INTRODUCTION TO PORT LOOPBACK DETECTION FUNCTION	9-3
9.2 PORT LOOPBACK DETECTION FUNCTION CONFIGURATION TASK LIST	9-3
9.3 PORT LOOPBACK DETECTION FUNCTION EXAMPLE	9-5
9.4 PORT LOOPBACK DETECTION TROUBLESHOOTING.....	9-5
CHAPTER 10 ULDP FUNCTION CONFIGURATION	10-6
10.1 INTRODUCTION TO ULDP FUNCTION	10-6
10.2 ULDP CONFIGURATION TASK SEQUENCE	10-7
10.3 ULDP FUNCTION TYPICAL EXAMPLES	10-9
10.4 ULDP TROUBLESHOOTING	10-10
CHAPTER 11 LLDP FUNCTION OPERATION CONFIGURATION	11-1
11.1 INTRODUCTION TO LLDP FUNCTION	11-1
11.2 LLDP FUNCTION CONFIGURATION TASK SEQUENCE	11-2
11.3 LLDP FUNCTION TYPICAL EXAMPLE.....	11-4
11.4 LLDP FUNCTION TROUBLESHOOTING.....	11-5
CHAPTER 12 PORT CHANNEL CONFIGURATION	12-1
12.1 INTRODUCTION TO PORT CHANNEL	12-1
12.2 BRIEF INTRODUCTION TO LACP.....	12-2
12.2.1 Static LACP Aggregation.....	12-2
12.2.2 Dynamic LACP Aggregation.....	12-3
12.3 PORT CHANNEL CONFIGURATION TASK LIST	12-3
12.4 PORT CHANNEL EXAMPLES.....	12-5
12.5 PORT CHANNEL TROUBLESHOOTING	12-7
CHAPTER 13 JUMBO CONFIGURATION.....	13-1
13.1 INTRODUCTION TO JUMBO	13-1
13.2 JUMBO CONFIGURATION TASK SEQUENCE	13-1
CHAPTER 14 VLAN CONFIGURATION	14-1
14.1 VLAN CONFIGURATION	14-1
14.1.1 Introduction to VLAN	14-1
14.1.2 VLAN Configuration Task List	14-2
14.1.3 Typical VLAN Application	14-4
14.1.4 Typical Application of Hybrid Port	14-6
14.2 GVRP CONFIGURATION	14-7
14.2.1 Introduction to GVRP	14-7
14.2.2 GVRP Configuration Task List.....	14-8
14.2.3 Typical GVRP Application	14-9

14.2.4 GVRP Troubleshooting	14-10
14.3 DOT1Q-TUNNEL CONFIGURATION	14-10
14.3.1 Introduction to Dot1q-tunnel.....	14-10
14.3.2 Dot1q-tunnel Configuration	14-11
14.3.3 Typical Applications of the Dot1q-tunnel	14-12
14.4 VLAN-TRANSLATION CONFIGURATION.....	14-13
14.4.1 Introduction to VLAN-translation	14-13
14.4.2 VLAN-translation Configuration	14-13
14.4.3 Typical application of VLAN-translation	14-14
14.4.4 VLAN-translation Troubleshooting	14-14
14.5 DYNAMIC VLAN CONFIGURATION.....	14-15
14.5.1 Introduction to Dynamic VLAN.....	14-15
14.5.2 Dynamic VLAN Configuration	14-15
14.5.3 Typical Application of the Dynamic VLAN	14-17
14.5.4 Dynamic VLAN Troubleshooting	14-18
14.6 VOICE VLAN CONFIGURATION	14-18
14.6.1 Introduction to Voice VLAN	14-18
14.6.2 Voice VLAN Configuration	14-19
14.6.3 Typical Applications of the Voice VLAN	14-19
14.6.4 Voice VLAN Troubleshooting	14-20
CHAPTER 15 MAC TABLE CONFIGURATION.....	15-1
15.1 INTRODUCTION TO MAC TABLE	15-1
15.1.1 Obtaining MAC Table	15-1
15.1.2 Forward or Filter.....	15-2
15.2 MAC ADDRESS TABLE CONFIGURATION TASK LIST.....	15-3
15.3 TYPICAL CONFIGURATION EXAMPLES	15-4
15.4 MAC TABLE TROUBLESHOOTING	15-4
15.5 MAC ADDRESS FUNCTION EXTENSION	15-5
15.5.1 MAC Address Binding	15-5
CHAPTER 16 MSTP CONFIGURATION.....	16-1
16.1 INTRODUCTION TO MSTP	16-1
16.1.1 MSTP Region.....	16-1
16.1.2 Port Roles	16-3
16.1.3 MSTP Load Balance	16-3
16.2 MSTP CONFIGURATION TASK LIST.....	16-3
16.3 MSTP EXAMPLE.....	16-6
16.4 MSTP TROUBLESHOOTING	16-10
CHAPTER 17 QOS CONFIGURATION.....	17-1
17.1 INTRODUCTION TO QoS	17-1

17.1.1 QoS Terms	17-1
17.1.2 QoS Implementation	17-2
17.1.3 Basic QoS Model	17-2
17.2 QoS CONFIGURATION TASK LIST	17-5
17.3 QoS EXAMPLE	17-9
17.4 QoS TROUBLESHOOTING.....	17-12
CHAPTER 18 PBR CONFIGURATION	18-1
18.1 INTRODUCTION TO PBR	18-1
18.2 PBR CONFIGURATION.....	18-1
18.3 PBR EXAMPLES	18-1
CHAPTER 19 IPV6 PBR CONFIGURATION	19-1
19.1 INTRODUCTION TO PBR (POLICY-BASED ROUTER)	19-1
19.2 PBR CONFIGURATION TASK SEQUENCE	19-1
19.3 PBR EXAMPLES	19-2
19.4 PBR TROUBLESHOOTING HELP	19-3
CHAPTER 20 FLOW-BASED REDIRECTION	20-4
20.1 INTRODUCTION TO FLOW-BASED REDIRECTION	20-4
20.2 FLOW-BASED REDIRECTION CONFIGURATION TASK SEQUENCE	20-4
20.3 FLOW-BASED REDIRECTION EXAMPLES	20-5
20.4 FLOW-BASED REDIRECTION TROUBLESHOOTING HELP.....	20-5
CHAPTER 21 LAYER 3 FORWARD CONFIGURATION	21-1
21.1 LAYER 3 INTERFACE.....	21-1
21.1.1 Introduction to Layer 3 Interface	21-1
21.1.2 Layer 3 Interface Configuration Task List.....	21-1
21.2 IP CONFIGURATION	21-2
21.2.1 Introduction to IPv4, IPv6.....	21-2
21.2.2 IP Configuration	21-4
21.2.3 IP Configuration Examples.....	21-10
21.2.4 IPv6 Troubleshooting	21-15
21.3 IP FORWARDING	21-15
21.3.1 Introduction to IP Forwarding.....	21-15
21.3.2 IP Route Aggregation Configuration Task	21-16
21.4 URPF	21-16
21.4.1 Introduction to URPF.....	21-16
21.4.2 URPF Configuration Task Sequence	21-17
21.4.3 URPF Typical Example	21-18
21.4.4 URPF Troubleshooting.....	21-19

21.5 ARP	21-19
21.5.1 Introduction to ARP	21-19
21.5.2 ARP Configuration Task List.....	21-19
21.5.3 ARP Troubleshooting	21-21
CHAPTER 22 ARP SCANNING PREVENTION FUNCTION CONFIGURATION.....	22-1
22.1 INTRODUCTION TO ARP SCANNING PREVENTION FUNCTION	22-1
22.2 ARP SCANNING PREVENTION CONFIGURATION TASK SEQUENCE	22-1
22.3 ARP SCANNING PREVENTION TYPICAL EXAMPLES.....	22-3
22.4 ARP SCANNING PREVENTION TROUBLESHOOTING HELP.....	22-4
CHAPTER 23 PREVENT ARP, ND SPOOFING CONFIGURATION.....	23-1
23.1 OVERVIEW.....	23-1
23.1.1 ARP (Address Resolution Protocol)	23-1
23.1.2 ARP Spoofing	23-1
23.1.3 How to prevent ARP/ND Spoofing	23-1
23.2 PREVENT ARP, ND SPOOFING CONFIGURATION	23-2
23.3 PREVENT ARP, ND SPOOFING EXAMPLE	23-3
CHAPTER 24 ARP GUARD CONFIGURATION	24-1
24.1 INTRODUCTION TO ARP GUARD	24-1
24.2 ARP GUARD CONFIGURATION TASK LIST	24-2
CHAPTER 25 ARP LOCAL PROXY CONFIGURATION.....	25-1
25.1 INTRODUCTION TO ARP LOCAL PROXY FUNCTION	25-1
25.2 ARP LOCAL PROXY FUNCTION CONFIGURATION TASK LIST.....	25-2
25.3 TYPICAL EXAMPLES OF ARP LOCAL PROXY FUNCTION	25-2
25.4 ARP LOCAL PROXY FUNCTION TROUBLESHOOTING	25-3
CHAPTER 26 GRATUITOUS ARP CONFIGURATION.....	26-1
26.1 INTRODUCTION TO GRATUITOUS ARP	26-1
26.2 GRATUITOUS ARP CONFIGURATION TASK LIST	26-1
26.3 GRATUITOUS ARP CONFIGURATION EXAMPLE	26-2
26.4 GRATUITOUS ARP TROUBLESHOOTING	26-2
CHAPTER 27 ND SNOOPING CONFIGURATION	27-1
27.1 INTRODUCTION TO ND SNOOPING.....	27-1
27.2 ND SNOOPING BASIC CONFIGURATION	27-1
27.3 ND SNOOPING EXAMPLE	27-3
27.4 ND SNOOPING TROUBLESHOOTING	27-4

CHAPTER 28 DHCP CONFIGURATION	28-1
28.1 INTRODUCTION TO DHCP	28-1
28.2 DHCP SERVER CONFIGURATION	28-2
28.3 DHCP RELAY CONFIGURATION	28-4
28.4 DHCP CONFIGURATION EXAMPLES	28-5
28.5 DHCP TROUBLESHOOTING	28-7
CHAPTER 29 DHCPV6 CONFIGURATION	29-1
29.1 INTRODUCTION TO DHCPV6.....	29-1
29.2 DHCPV6 SERVER CONFIGURATION	29-2
29.3 DHCPV6 RELAY DELEGATION CONFIGURATION	29-3
29.4 DHCPV6 PREFIX DELEGATION SERVER CONFIGURATION	29-4
29.5 DHCPV6 PREFIX DELEGATION CLIENT CONFIGURATION	29-5
29.6 DHCPV6 CONFIGURATION EXAMPLES	29-6
29.7 DHCPV6 TROUBLESHOOTING	29-9
CHAPTER 30 DHCP OPTION 82 CONFIGURATION.....	30-1
30.1 INTRODUCTION TO DHCP OPTION 82	30-1
30.1.1 DHCP Option 82 Message Structure	30-1
30.1.2 Option 82 Working Mechanism	30-2
30.2 DHCP OPTION 82 CONFIGURATION TASK LIST	30-2
30.3 DHCP OPTION 82 APPLICATION EXAMPLES	30-4
CHAPTER 31 DHCP SNOOPING CONFIGURATION	31-1
31.1 INTRODUCTION TO DHCP SNOOPING.....	31-1
31.2 DHCP SNOOPING CONFIGURATION TASK SEQUENCE.....	31-2
31.3 DHCP SNOOPING TYPICAL APPLICATION.....	31-4
31.4 DHCP SNOOPING TROUBLESHOOTING HELP	31-5
31.4.1 Monitor and Debug Information	31-5
31.4.2 DHCP Snooping Troubleshooting Help.....	31-6
CHAPTER 32 DHCPV6 SNOOPING CONFIGURATION.....	32-1
32.1 INTRODUCTION TO DHCPV6 SNOOPING.....	32-1
32.1.1 Defense against Fake DHCPv6 Server	32-1
32.1.2 Defense against Fake IPv6 Address	32-1
32.1.3 Defense against the attack of DHCPv6 addresses exhaustion	32-1
32.1.4 Defense against ND cheat	32-1
32.1.5 Reply the removal requirement for port	32-2
32.2 DHCPV6 SNOOPING CONFIGURATION TASK SEQUENCE.....	32-2

32.3 DHCPV6 SNOOPING TYPICAL APPLICATION	32-4
32.4 DHCPV6 SNOOPING TROUBLESHOOTING	32-5
32.4.1 Monitor and Debug Information	32-5
32.4.2 DHCPv6 Snooping Troubleshooting Help	32-5
CHAPTER 33 ROUTING PROTOCOL OVERVIEW	33-1
33.1 ROUTING TABLE	33-1
33.2 IP ROUTING POLICY	33-2
33.2.1 Introduction to Routing Policy	33-2
33.2.2 IP Routing Policy Configuration Task List	33-4
33.2.3 Configuration Examples	33-7
33.2.4 Troubleshooting	33-8
CHAPTER 34 STATIC ROUTE	34-1
34.1 INTRODUCTION TO STATIC ROUTE	34-1
34.2 INTRODUCTION TO DEFAULT ROUTE	34-1
34.3 STATIC ROUTE CONFIGURATION TASK LIST	34-1
34.4 STATIC ROUTE CONFIGURATION EXAMPLES	34-2
CHAPTER 35 RIP	35-1
35.1 INTRODUCTION TO RIP	35-1
35.2 RIP CONFIGURATION TASK LIST	35-2
35.3 RIP EXAMPLES	35-8
35.3.1 Typical RIP Examples	35-8
35.3.2 Typical Examples of RIP aggregation function	35-10
35.4 RIP TROUBLESHOOTING	35-11
CHAPTER 36 RIPNG	36-1
36.1 INTRODUCTION TO RIPNG	36-1
36.2 RIPNG CONFIGURATION TASK LIST	36-2
36.3 RIPNG CONFIGURATION EXAMPLES	36-6
36.3.1 Typical RIPng Examples	36-6
36.3.2 RIPng Aggregation Route Function Typical Examples	36-8
36.4 RIPNG TROUBLESHOOTING	36-9
CHAPTER 37 OSPF	37-1
37.1 INTRODUCTION TO OSPF	37-1
37.2 OSPF CONFIGURATION TASK LIST	37-3
37.3 OSPF EXAMPLES	37-8
37.3.1 Configuration Example of OSPF	37-8
37.3.2 Configuration Examples of OSPF VPN	37-16

37.4 OSPF TROUBLESHOOTING	37-18
CHAPTER 38 OSPFV3	38-1
38.1 INTRODUCTION TO OSPFV3	38-1
38.2 OSPFV3 CONFIGURATION TASK LIST	38-4
38.3 OSPFV3 EXAMPLES	38-7
38.4 OSPFV3 TROUBLESHOOTING	38-10
CHAPTER 39 BGP	39-1
39.1 INTRODUCTION TO BGP	39-1
39.2 BGP CONFIGURATION TASK LIST	39-4
39.3 CONFIGURATION EXAMPLES OF BGP	39-15
39.3.1 Example 1: configure BGP neighbor.....	39-15
39.3.2 Example 2: configure BGP aggregation.....	39-16
39.3.3 Example 3: configure BGP community attributes	39-17
39.3.4 Example 4: configure BGP confederation.....	39-18
39.3.5 Example 5: configure BGP route reflector	39-19
39.3.6 Example 6: configure MED of BGP.....	39-21
39.3.7 Example 7: example of BGP VPN	39-23
39.4 BGP TROUBLESHOOTING	39-27
CHAPTER 40 MBGP4+	40-1
40.1 INTRODUCTION TO MBGP4+	40-1
40.2 MBGP4+ CONFIGURATION TASK LIST	40-1
40.3 MBGP4+ EXAMPLES.....	40-2
40.4 MBGP4+ TROUBLESHOOTING	40-4
CHAPTER 41 BLACK HOLE ROUTING MANUAL	41-1
41.1 INTRODUCTION TO BLACK HOLE ROUTING	41-1
41.2 IPV4 BLACK HOLE ROUTING CONFIGURATION TASK.....	41-1
41.3 IPV6 BLACK HOLE ROUTING CONFIGURATION TASK.....	41-1
41.4 BLACK HOLE ROUTING CONFIGURATION EXMAPLES	41-2
41.5 BLACK HOLE ROUTING TROUBLESHOOTING	41-3
CHAPTER 42 ECMP CONFIGURATION	42-1
42.1 INTRODUCTION TO ECMP	42-1
42.2 ECMP CONFIGURATION TASK LIST	42-1
42.3 ECMP TYPICAL EXAMPLE.....	42-2
42.3.1 Static Route Implements ECMP	42-2
42.3.2 OSPF Implements ECMP	42-3

CHAPTER 43 IPV4 MULTICAST PROTOCOL	43-1
43.1 IPV4 MULTICAST PROTOCOL OVERVIEW	43-1
43.1.1 Introduction to Multicast	43-1
43.1.2 Multicast Address	43-1
43.1.3 IP Multicast Packet Transmission	43-3
43.1.4 IP Multicast Application	43-3
43.2 PIM-DM.....	43-4
43.2.1 Introduction to PIM-DM	43-4
43.2.2 PIM-DM Configuration Task List.....	43-5
43.2.3 PIM-DM Configuration Examples.....	43-7
43.2.4 PIM-DM Troubleshooting	43-8
43.3 PIM-SM.....	43-8
43.3.1 Introduction to PIM-SM	43-8
43.3.2 PIM-SM Configuration Task List.....	43-9
43.3.3 PIM-SM Configuration Examples.....	43-13
43.3.4 PIM-SM Troubleshooting.....	43-14
43.4 MSDP CONFIGURATION	43-15
43.4.1 Introduction to MSDP	43-15
43.4.2 Brief Introduction to MSDP Configuration Tasks.....	43-16
43.4.3 Configuration of MSDP Basic Function.....	43-16
43.4.4 Configuration of MSDP Entities.....	43-17
43.4.5 Configuration of Delivery of MSDP Packet	43-18
43.4.6 Configuration of Parameters of SA-cache	43-19
43.4.7 MSDP Configuration Examples.....	43-19
43.4.8 MSDP Troubleshooting	43-24
43.5 ANYCAST RP CONFIGURATION	43-25
43.5.1 Introduction to ANYCAST RP.....	43-25
43.5.2 ANYCAST RP Configuration Task.....	43-25
43.5.3 ANYCAST RP Configuration Examples	43-28
43.5.4 ANYCAST RP Troubleshooting.....	43-29
43.6 PIM-SSM	43-30
43.6.1 Introduction to PIM-SSM.....	43-30
43.6.2 PIM-SSM Configuration Task List	43-30
43.6.3 PIM-SSM Configuration Examples	43-30
43.6.4 PIM-SSM Troubleshooting	43-32
43.7 DVMRP.....	43-32
43.7.1 Introduction to DVMRP	43-32
43.7.2 DVMRP Configuration Task List.....	43-34
43.7.3 DVMRP Configuration Examples.....	43-36
43.7.4 DVMRP Troubleshooting.....	43-36
43.8 DCSCM.....	43-37
43.8.1 Introduction to DCSCM	43-37
43.8.2 DCSCM Configuration Task List.....	43-38

43.8.3 DCSCM Configuration Examples.....	43-40
43.8.4 DCSCM Troubleshooting	43-41
43.9 IGMP.....	43-41
43.9.1 Introduction to IGMP	43-41
43.9.2 IGMP Configuration Task List.....	43-43
43.9.3 IGMP Configuration Examples.....	43-45
43.9.4 IGMP Troubleshooting	43-46
43.10 IGMP SNOOPING.....	43-46
43.10.1 Introduction to IGMP Snooping.....	43-46
43.10.2 IGMP Snooping Configuration Task List	43-47
43.10.3 IGMP Snooping Examples	43-49
43.10.4 IGMP Snooping Troubleshooting	43-51
43.11 IGMP PROXY CONFIGURATION	43-51
43.11.1 Introduction to IGMP Proxy	43-51
43.11.2 IGMP Proxy Configuration Task List.....	43-52
43.11.3 IGMP Proxy Examples	43-53
43.11.4 IGMP Proxy Troubleshooting	43-55
CHAPTER 44 IPV6 MULTICAST PROTOCOL	44-1
44.1 PIM-DM6.....	44-1
44.1.1 Introduction to PIM-DM6	44-1
44.1.2 PIM-DM6 Configuration Task List.....	44-2
44.1.3 PIM-DM6 Typical Application	44-4
44.1.4 PIM-DM6 Troubleshooting	44-5
44.2 PIM-SM6.....	44-6
44.2.1 Introduction to PIM-SM6	44-6
44.2.2 PIM-SM6 Configuration Task List.....	44-7
44.2.3 PIM-SM6 Typical Application.....	44-10
44.2.4 PIM-SM6 Troubleshooting	44-12
44.3 ANYCAST RP v6 CONFIGURATION	44-12
44.3.1 Introduction to ANYCAST RP v6.....	44-12
44.3.2 ANYCAST RP v6 Configuration Task.....	44-13
44.3.3 ANYCAST RP v6 Configuration Examples	44-15
44.3.4 ANYCAST RP v6 Troubleshooting	44-16
44.4 PIM-SSM6	44-17
44.4.1 Introduction to PIM-SSM6.....	44-17
44.4.2 PIM-SSM6 Configuration Task List	44-17
44.4.3 PIM-SSM6 Configuration Example	44-17
44.4.4 PIM-SSM6 Troubleshooting	44-20
44.5 IPv6 DCSCM	44-20
44.5.1 Introduction to IPv6 DCSCM.....	44-20
44.5.2 IPv6 DCSCM Configuration Task Sequence.....	44-21
44.5.3 IPv6 DCSCM Typical Examples.....	44-23
44.5.4 IPv6 DCSCM Troubleshooting	44-24

44.6 MLD	44-24
44.6.1 Introduction to MLD	44-24
44.6.2 MLD Configuration Task List	44-25
44.6.3 MLD Typical Application	44-27
44.6.4 MLD Troubleshooting Help	44-27
44.7 MLD SNOOPING	44-28
44.7.1 Introduction to MLD Snooping	44-28
44.7.2 MLD Snooping Configuration Task	44-28
44.7.3 MLD Snooping Examples	44-30
44.7.4 MLD Snooping Troubleshooting.....	44-32
CHAPTER 45 MULTICAST VLAN	45-1
45.1 INTRODUCTIONS TO MULTICAST VLAN	45-1
45.2 MULTICAST VLAN CONFIGURATION TASK LIST	45-1
45.3 MULTICAST VLAN EXAMPLES	45-2
CHAPTER 46 ACL CONFIGURATION	46-1
46.1 INTRODUCTION TO ACL	46-1
46.1.1 Access-list	46-1
46.1.2 Access-group	46-1
46.1.3 Access-list Action and Global Default Action.....	46-1
46.2 ACL CONFIGURATION TASK LIST	46-2
46.3 ACL EXAMPLE	46-16
46.4 ACL TROUBLESHOOTING	46-20
CHAPTER 47 802.1X CONFIGURATION	47-1
47.1 INTRODUCTION TO 802.1X	47-1
47.1.1 The Authentication Structure of 802.1x	47-1
47.1.2 The Work Mechanism of 802.1x	47-3
47.1.3 The Encapsulation of EAPOL Messages	47-3
47.1.4 The Encapsulation of EAP Attributes	47-5
47.1.5 Web Authentication Proxy based on 802.1x	47-6
47.1.6 The Authentication Methods of 802.1x.....	47-6
47.1.7 The Extension and Optimization of 802.1x	47-11
47.1.8 The Features of VLAN Allocation	47-12
47.2 802.1X CONFIGURATION TASK LIST	47-13
47.3 802.1X APPLICATION EXAMPLE	47-16
47.3.1 Examples of Guest VLAN Applications	47-16
47.3.2 Examples of IPv4 RADIUS Applications	47-19
47.3.3 Examples of IPv6 RADIUS Application	47-20
47.3.4 802.1x Web Proxy Authentication Sample Application	47-21
47.4 802.1X TROUBLESHOOTING	47-22

CHAPTER 48 THE NUMBER LIMITATION FUNCTION OF PORT, MAC IN VLAN AND IP CONFIGURATION.....	48-1
48.1 INTRODUCTION TO THE NUMBER LIMITATION FUNCTION OF PORT, MAC IN VLAN AND IP	48-1
48.2 THE NUMBER LIMITATION FUNCTION OF PORT, MAC IN VLAN AND IP CONFIGURATION TASK SEQUENCE	48-2
48.3 THE NUMBER LIMITATION FUNCTION OF PORT, MAC IN VLAN AND IP TYPICAL EXAMPLES.....	48-4
48.4 THE NUMBER LIMITATION FUNCTION OF PORT, MAC IN VLAN AND IP TROUBLESHOOTING HELP	48-5
CHAPTER 49 OPERATIONAL CONFIGURATION OF AM FUNCTION	49-1
49.1 INTRODUCTION TO AM FUNCTION	49-1
49.2 AM FUNCTION CONFIGURATION TASK LIST	49-1
49.3 AM FUNCTION EXAMPLE	49-3
49.4 AM FUNCTION TROUBLESHOOTING	49-3
CHAPTER 50 SECURITY FEATURE CONFIGURATION	50-1
50.1 INTRODUCTION TO SECURITY FEATURE	50-1
50.2 SECURITY FEATURE CONFIGURATION	50-1
50.2.1 Prevent IP Spoofing Function Configuration Task Sequence	50-1
50.2.2 Prevent TCP Unauthorized Label Attack Function Configuration Task Sequence	50-1
50.2.3 Anti Port Cheat Function Configuration Task Sequence	50-2
50.2.4 Prevent TCP Fragment Attack Function Configuration Task Sequence	50-2
50.2.5 Prevent ICMP Fragment Attack Function Configuration Task Sequence	50-2
50.3 SECURITY FEATURE EXAMPLE	50-3
CHAPTER 51 TACACS+ CONFIGURATION.....	51-1
51.1 INTRODUCTION TO TACACS+	51-1
51.2 TACACS+ CONFIGURATION TASK LIST	51-1
51.3 TACACS+ SCENARIOS TYPICAL EXAMPLES.....	51-2
51.4 TACACS+ TROUBLESHOOTING	51-3
CHAPTER 52 RADIUS CONFIGURATION.....	52-1
52.1 INTRODUCTION TO RADIUS	52-1
52.1.1 AAA and RADIUS Introduction.....	52-1
52.1.2 Message structure for RADIUS.....	52-1
52.2 RADIUS CONFIGURATION TASK LIST	52-3
52.3 RADIUS TYPICAL EXAMPLES	52-5
52.3.1 IPv4 RADIUS Example	52-5
52.3.2 IPv6 RADIUS Example	52-6
52.4 RADIUS TROUBLESHOOTING	52-6

CHAPTER 53 SSL CONFIGURATION.....	53-1
53.1 INTRODUCTION TO SSL.....	53-1
53.1.1 Basic Element of SSL	53-1
53.2 SSL CONFIGURATION TASK LIST	53-2
53.3 SSL TYPICAL EXAMPLE	53-3
53.4 SSL TROUBLESHOOTING	53-4
CHAPTER 54 IPV6 SECURITY RA CONFIGURATION.....	54-1
54.1 INTRODUCTION TO IPV6 SECURITY RA.....	54-1
54.2 IPV6 SECURITY RA CONFIGURATION TASK SEQUENCE.....	54-1
54.3 IPV6 SECURITY RA TYPICAL EXAMPLES.....	54-2
54.4 IPV6 SECURITY RA TROUBLESHOOTING HELP.....	54-2
CHAPTER 55 VLAN-ACL CONFIGURATION	55-1
55.1 INTRODUCTION TO VLAN-ACL	55-1
55.2 VLAN-ACL CONFIGURATION TASK LIST	55-1
55.3 VLAN-ACL CONFIGURATION EXAMPLE.....	55-3
55.4 VLAN-ACL TROUBLESHOOTING.....	55-4
55.5 INTRODUCTION TO MIRROR.....	55-4
55.6 MIRROR CONFIGURATION TASK LIST.....	55-5
55.7 MIRROR EXAMPLES	55-6
55.8 DEVICE MIRROR TROUBLESHOOTING.....	55-6
CHAPTER 56 RSPAN CONFIGURATION	56-1
56.1 INTRODUCTION TO RSPAN	56-1
56.2 RSPAN CONFIGURATION TASK LIST	56-2
56.3 TYPICAL EXAMPLES OF RSPAN.....	56-4
56.4 RSPAN TROUBLESHOOTING.....	56-7
CHAPTER 57 SFLOW CONFIGURATION.....	57-1
57.1 INTRODUCTION TO SFLOW	57-1
57.2 SFLOW CONFIGURATION TASK LIST	57-1
57.3 SFLOW EXAMPLES.....	57-3
57.4 SFLOW TROUBLESHOOTING	57-3
CHAPTER 58 VRRP CONFIGURATION.....	58-1
58.1 INTRODUCTION TO VRRP	58-1
58.2 VRRP CONFIGURATION TASK LIST.....	58-2

58.3 VRRP TYPICAL EXAMPLES	58-3
58.4 VRRP TROUBLESHOOTING	58-4
CHAPTER 59 IPV6 VRRPV3 CONFIGURATION.....	59-1
59.1 INTRODUCTION TO VRRPV3	59-1
59.1.1 The Format of VRRPV3 Message	59-2
59.1.2 VRRPV3 Working Mechanism.....	59-3
59.2 VRRPV3 CONFIGURATION	59-4
59.2.1 Configuration Task Sequence	59-4
59.3 VRRPV3 TYPICAL EXAMPLES	59-5
59.4 VRRPV3 TROUBLESHOOTING	59-6
CHAPTER 60 MRPP CONFIGURATION	60-1
60.1 INTRODUCTION TO MRPP	60-1
60.1.1 Conception Introduction	60-1
60.1.2 MRPP Protocol Packet Types	60-2
60.1.3 MRPP Protocol Operation System.....	60-3
60.2 MRPP CONFIGURATION TASK LIST	60-3
60.3 MRPP TYPICAL SCENARIO	60-5
60.4 MRPP TROUBLESHOOTING.....	60-7
CHAPTER 61 ULPP CONFIGURATION	61-1
61.1 INTRODUCTION TO ULPP	61-1
61.2 ULPP CONFIGURATION TASK LIST	61-2
61.3 ULPP TYPICAL EXAMPLES	61-4
61.3.1 ULPP Typical Example1.....	61-4
61.3.2 ULPP Typical Example2.....	61-6
61.4 ULPP TROUBLESHOOTING.....	61-7
CHAPTER 62 ULSM CONFIGURATION	62-1
62.1 INTRODUCTION TO ULSM.....	62-1
62.2 ULSM CONFIGURATION TASK LIST.....	62-2
62.3 ULSM TYPICAL EXAMPLE.....	62-3
62.4 ULSM TROUBLESHOOTING	62-4
CHAPTER 63 SNTP CONFIGURATION	63-1
63.1 INTRODUCTION TO SNTP	63-1
63.2 TYPICAL EXAMPLES OF SNTP CONFIGURATION	63-2
CHAPTER 64 NTP FUNCTION CONFIGURATION	64-1

64.1 INTRODUCTION TO NTP FUNCTION	64-1
64.2 NTP FUNCTION CONFIGURATION TASK LIST.....	64-1
64.3 TYPICAL EXAMPLES OF NTP FUNCTION.....	64-4
64.4 NTP FUNCTION TROUBLESHOOTING.....	64-4
CHAPTER 65 DNSV4/V6 CONFIGURATION	65-1
65.1 INTRODUCTION TO DNS	65-1
65.2 DNSV4/V6 CONFIGURATION TASK LIST	65-2
65.3 TYPICAL EXAMPLES OF DNS.....	65-4
65.4 DNS TROUBLESHOOTING.....	65-5
CHAPTER 66 MONITOR AND DEBUG	66-1
66.1 PING	66-1
66.2 PING6	66-1
66.3 TRACEROUTE	66-1
66.4 TRACEROUTE6	66-2
66.5 SHOW	66-2
66.6 DEBUG.....	66-3
66.7 SYSTEM LOG	66-3
66.7.1 System Log Introduction	66-3
66.7.2 System Log Configuration.....	66-5
66.7.3 System Log Configuration Example.....	66-6
CHAPTER 67 RELOADING SWITCH AFTER SPECIFIED TIME.....	67-1
67.1 INTRODUCTION TO RELOADING OF SWITCH AFTER SPECIFID TIME	67-1
67.2 RELOADING SWITCH AFTER SPECIFID TIME TASK LIST.....	67-1
CHAPTER 68 DEBUGGING AND DIAGNOSIS FOR PACKETS RECEIVED AND SENT BY CPU	68-1
68.1 INTRODUCTION TO DEBUGGING AND DIAGNOSIS FOR PACKETS RECEIVED AND SENT BY CPU.....	68-1
68.2 DEBUGGING AND DIAGNOSIS FOR PACKETS RECEIVED AND SENT BY CPU TASK LIST	68-1
CHAPTER 69 SWITCH OPERATION	69-1
69.1 ADDRESS TABLE.....	69-1
69.2 LEARNING	69-1
69.3 FORWARDING & FILTERING.....	69-1
69.4 STORE-AND-FORWARD	69-1
69.5 AUTO-NEGOTIATION.....	69-2

CHAPTER 70 TROUBLESHOOTING	70-1
CHAPTER 71 APPENDIX A.....	71-1
71.1 A.1 SWITCH'S RJ-45 PIN ASSIGNMENTS.....	71-1
71.2 A.2 10/100MBPS, 10/100BASE-TX.....	71-1
CHAPTER 72 GLOSSARY.....	72-1

Chapter 1 INTRODUCTION of XGS3-42000R

1.1 Packet Contents

Thank you for purchasing PLANET XGS3-42000R 4-slot Layer 3 IPv6/IPv4 Routing Chassis Switch. The term “**Chassis Switch**” refers to the XGS3-42000R mentioned this User’s manual.

Open the box of the Chassis Switch and carefully unpack it. The box should contain the following items

- XGS3-42000R Chassis Switch** x 1
- XGS3-PWR-AC** x 1
- Quick Installation Guide** x 1
- RJ45-to-DB9 Console Cable** x 1
- Power Cord** x 1
- Ground Cable** x 1
- Two Rack-mounting Brackets with Attachment Screws** x 1

The XGS3-42000R supports various types of Ethernet module, and can seamlessly support network interfaces from 100Mbps and 1000Mbps to 10Gbps Ethernet. The Ethernet module should contain the following model names:

Model Name	Product Description
XGS3-M16C8S	XGS3-42000R Management Module with 24-port Gigabit (16-port TP/SFP combo + 8-port 100/1000X SFP)
XGS3-S16C8S4X	XGS3-42000R Standard Ethernet Module with 24-port Gigabit (16-port TP/SFP combo + 8-port 100/1000X SFP) + 4-port 10G SFP+
XGS3-S48G	XGS3-42000R Standard Ethernet Module with 48-port 10/100/1000Mbps

The term “**Management Module**” refers to the XGS3-M16C8S mentioned in this user’s manual. And the term “**Standard Ethernet Module**” means the XGS3-S16C8S4X and XGS3-S48G, mentioned in this user’s manual.

Open the box of the Management/Standard Ethernet Module and carefully unpack it. The box should contain the following items.

- Management Module/Standard Ethernet Module** x 1
- Quick Installation Guide** x 1

If any of these are missing or damaged, please contact your dealer immediately, if possible, retain the carton including the original packing material, and use them again to repack the product in case there is a need to return it to us for repair.

1.2 Product Description

Overview

PLANET XGS3-42000R Core-Layer Routing Switch is specially designed for large network applications such as enterprises, campuses, communities, ISPs and data center networks where **flexible configuration, large capacity, high density, high reliability** and **advanced traffic management** are required.

The XGS3-42000R is a High-Density Chassis Ethernet Switch built with 4 module slots and redundant power supply. It provides great porting flexibility for network deployment by offering various combinable management modules and standard interfaces. For instance, one management module can be collaborated with three standard modules, or two management modules work with two standard modules to perform mutually system backup. Within the 6U height, single chassis, the maximum configuration can be:

- **160 10/100/1000BASE-T Copper Slots**
- **96 100/1000BASE-SX/LX SFP Fiber Slots**
- **12 10G SFP+ Fiber Slots**

Positioned as the core layer switch, the XGS3-42000R serves ideally for large- and medium-sized networks and IP metropolitan networks by supplying advanced intelligent and secure features and giving high performance and flexibility.

Supporting 10-Gigabit Ethernet

10-Gigabit Ethernet, which adopts full-duplex technology instead of low-speed, half-duplex CSMA/CD protocol, is a big leap in the evolution of Ethernet. 10-Gigabit Ethernet can be deployed in star or ring topology. With 10-Gigabit Ethernet technology applied, the XGS3-42000R provides broad bandwidth and powerful processing capacity. It is suitable for metropolitan networks and wide area networks. Using the XGS3-42000R, users can simplify network structures and reduce cost of network construction.

Full IPv6 Support

The XGS3-42000R Chassis Switch supports IPv6 routing in hardware for maximum performance. As more network devices are growing and the need for larger addressing and higher security becomes critical, the XGS3-42000R Chassis Switch is the right product to meet the requirements.

Scalable Performance

The XGS3-42000R delivers wire-speed Gigabit and 10-Gigabit Ethernet connectivity in a highly-flexible and resilient modular platform. With high switching capacity, the XGS3-42000R Chassis Switch supports wire-speed L2/L3 forwarding and high routing performance for IPv4 and IPv6 protocols. The scalable and flexible modular architecture supports up to 376Gps forwarding performance in a single system. The XGS3-42000R is ideal for the core layer of campuses, enterprise networks and the aggregation layer of IP metropolitan networks.

Rich Multi-Layer and Multicast Networking Protocols

The XGS3-42000R supports various Layer 2 and management networking protocols to meet the requirements of complex network constructions. It is compatible with 802.1d/w/s, 802.1Q, 802.1p, 802.3ad, 802.3x, GVRP, DHCP, SNMP, etc.

The Chassis Switch also supports **IPv6/IPv4 routing** protocols including Layer 3 IP Static Routing, RIPv1/v2, OSPF, and VRRP protocols. Built in with abundant multicast features, the XGS3-42000R supports rich L2 multicast features such as **IGMP snooping v1/v2/v3** and L3 multicast protocols -- **DVMRP, PIM-DM, PIM-SM** and **PIM-SSM**. Offering the rich application experience, the product supports multicast VLAN registration, multicast receive control and illegal multicast source detect functions. The XGS3-42000R Chassis Switch solution is cost-effective yet has the ability to expand to meet today's demand for network expansion.

Enhanced Security

PLANET XGS3-42000R offers comprehensive Layer 2 to Layer 4 Access Control List (ACL) for enforcing security to the edge. It can be used to restrict network access by denying packets based on source and destination IP address, TCP/UDP ports or defined typical network applications. Its protection mechanism also comprises 802.1x port-based and MAC-based user and device authentication. With the private VLAN function, communication between edge ports can be prevented to ensure user privacy. The XGS3-42000R Net Security also provides **DHCP Snooping, IP Source Guard** and **Dynamic ARP Inspection** functions to prevent from IP snooping attack and discard ARP packets with invalid MAC address. The network administrators can now construct highly-secured corporate networks with considerably less time and effort than before.

Enhanced Quality of Service

The XGS3-42000R Switch fully supports DiffServ module, so users can specify a queue bandwidth on each port. WRR/SP/SWRR scheduling is also provided. The XGS3-42000R supports the port security to enable trusted CoS, DSCP, IP precedence and port priority. Users can modify packets' DSCP and COS values so that the traffic can be classified by port, VLAN, DSCP, IP precedence and ACL table. User can also modify packets' DSCP and IP precedence values to specify different bandwidths for voice, data and video to customize different qualities of service.

Efficient and Secure Management

For efficient management, the XGS3-42000R Chassis Switch is equipped with console, Web and SNMP management interfaces. With the built-in Web-based management interface, the XGS3-42000R offers an easy-to-use, platform-independent management and configuration facility. The XGS3-42000R supports standard Simple Network Management Protocol (SNMP) and can be managed via any standard-based management software. For text-based management, the XGS3-42000R can be accessed via Telnet and the console port. Moreover, the XGS3-42000R offers secure remote management by supporting **SSH, SSL** and **SNMPv3** connection which encrypt the packet content at each session.

1.3 Product Features

➤ **Hardware and Performance**

- 4 open module slots design:
 - 2 Management Modules with 2 Standard Modules
 - 1 Management Module with 3 Standard Modules
- 160-port Gigabit copper, 96-port Gigabit SFP and 12-port 10G SFP+
- Hot-swappable switching modules
- Non-blocking wire-speed Layer 2 and Layer 3 switching
- 1 RJ45 serial console interface on Management Module for Switch basic management and setup

➤ **Redundant Power System**

- 100~240V AC dual power redundant
 - 1 default AC power supply
 - 1 additional open slot for optional power supply
- Active-active redundant power failure protection
- Backup of catastrophic power failure on one supply

➤ **IP Stacking**

- IP stacking technology, connect with stack member via any Gigabit or 10G interface
- Single IP address management, supports up to 24 units stacking together

➤ **IP Routing Features**

- IP Routing protocol supports RIP v1/v2, OSPF v2, BGP4
- Routing interface provides VLAN routing mode
- Policy based Routing(PBR) for IPv4 and IPv6
- VRRP protocol for redundant routing deployment
- Supports route redistribution

➤ **Multicast Routing Features**

- Supports Multicast Routing Protocols:
 - PIM-DM (Protocol Independent Multicast - Dense Mode)
 - PIM-SM (Protocol Independent Multicast - Sparse Mode)
 - PIM-SSM (Protocol Independent Multicast - Source-Specific Multicast Mode)
 - DVMRP (Distance Vector Multicast Routing Protocol)
- Supports IGMP v1/v2/v3

➤ **Layer 2 Features**

- Supports auto-negotiation, auto-MDI/MDI-x and half-duplex/full-duplex modes for all 1000BASE-T ports.
- Prevents packet loss with back pressure (half-duplex) and IEEE 802.3x pause frame flow control (full-duplex)

- Supports VLAN
 - IEEE 802.1Q tagged VLAN
 - Up to 4K VLANs groups, out of 4041 VLAN IDs
 - Provider Bridging (VLAN Q-in-Q) support (IEEE 802.1ad)
 - GVRP protocol for VLAN Management
 - Private VLAN Edge (PVE)
- Supports Spanning Tree Protocol
 - STP, IEEE 802.1d (Spanning Tree Protocol)
 - RSTP, IEEE 802.1w (Rapid Spanning Tree Protocol)
 - MSTP, IEEE 802.1s (Multiple Spanning Tree Protocol, spanning tree by VLAN)
- Supports Link Aggregation
 - 802.3ad Link Aggregation Control Protocol (LACP)
 - Cisco ether-channel (static trunk)
 - Maximum 128 trunk groups, up to 8 ports per trunk group
 - Up to 16Gbps bandwidth (Duplex Mode)
- Provides Port Mirror (many-to-1)
- Port Mirroring to monitor the incoming or outgoing traffic on a particular port

➤ **Quality of Service**

- 8 priority queues on all switch ports
- Supports for strict priority and Weighted Round Robin (WRR) CoS policies
- Ingress Shaper and Egress Rate Limit per port bandwidth control
- Traffic-policing policies based on application

➤ **Multicast**

- Supports IGMP Snooping v1, v2 and v3
- Querier mode support

➤ **Security**

- IEEE 802.1x Port-based network access authentication
- MAC-based network access authentication
- IP-based Access Control List (ACL)
- MAC-based Access Control List
- Static MAC

➤ **Management**

- IPv4/IPv6 Switch Management Interfaces
 - Console/Telnet Command Line Interface
 - Web switch management
 - SNMP v1, v2c, and v3 switch management
 - SSH (Secure Shell)/SSL secure access
- Four RMON groups (history, statistics, alarms and events)
- IPv6 IP Address/NTP/DNS management
- Built-in Trivial File Transfer Protocol (TFTP) client
- BOOTP and DHCP for IP address assignment

- DHCP/BOOTP relay and Relay Option 82
- DHCP Server
- DNS-Proxy
- Firmware upload/download via FTP/TFTP
- SNTP (Simple Network Time Protocol)
- LLDP (Link Layer Discovery Protocol)
- User Privilege levels control

1.4 Product Specifications

1.4.1 XGS3-42000R Specification

Product	XGS3-42000R
Hardware Version	2
Chassis Slots	
Total Number of Slots	4 (2 management modules + 2 standard modules) or (1 management module + 3 standard modules)
Max. Management Module	2 (slot 1, slot 2)
Max. Standard Module	3 (slot 2, 3, 4)
Management Module Redundancy	Yes
Number of Power Supply Bays	2
Number of Fan Trays	1, hot-pluggable
Total Port Capacity	
Max. 10G SFP+ Slots	12
Max. 10/100/1000BASE-T Slots	160
Max. 1000BASE-SX/LX SFP Slots	96
Modules	
XGS3-M16C8S	24-port Gigabit (16-port TP/SFP combo + 8-port 100/1000X SFP)/MGMT module
XGS3-S16C8S4X	24-port Gigabit (16-port TP/SFP combo + 8-port 100/1000X SFP) + 4-port 10G SFP+ Switch module/Standard module

XGS3-S48G	48-port 10/100/1000BASE-T Switch module/Standard module
Performance	
Switch Processing Scheme	Store-and-Forward
MAC Table	64K
VLAN Table	4K
ACL Table	16K max.
Routing Table	IPv4 Protocol: 128K max. IPv6 Protocol: 64K max.
Layer 3 Interface	500
Port Queues	8
Flow Control	IEEE 802.3x pause frame for full-duplex Back pressure for half-duplex
Jumbo Frame	9Kbytes
Hardware Specifications	
Dimensions (W x D x H)	440 x 421 x 266 mm
Relative Humidity	10%~90%, non-condensing
Operating Temperature	0°C~50°C
Power Input	AC: Input 100~240V, 50~60 Hz;
Power Consumption	≤500W
IPv4 Layer 3 Functions	
IP Routing Protocol	Static Route, RIPv1/v2, OSPFv2, BGP4 Policy-based Routing (PBR) LPM Routing (MD5 authentication)
Multicast Routing Protocol	IGMP v1/2/3, DVMRP, PIM-DM/SM, PIM-SSM
IPv4 Layer 3 Protocol	VRRP, ARP, ARP proxy
Routing Interface	Per VLAN
IPv6 Layer 3 Functions	
IP Routing Protocol	RIPng, OSPFv3, BGP4+
Multicast Routing Protocol	PIM-SM/DM for IPv6 MLD for IPv6 MLDv1/v2 MLD snooping, 6 to 4 tunnels Multicast receive control Illegal multicast source detect
IPv6 Layer 3 Protocol	Configured tunnels, ISATAP, CIDR
Layer 2 Functions	

Port Configuration	<p>Port disable/enable</p> <p>Auto-negotiation 10/100/1000Mbps full and half duplex mode selection</p> <p>Bandwidth control on each port</p> <p>Port loopback detect</p>
VLAN	<p>802.1Q tagged based VLAN, up to 4K VLAN groups</p> <p>Q-in-Q</p> <p>GVRP</p> <p>Private VLAN</p>
Spanning Tree Protocol	<p>STP, IEEE 802.1d (Spanning Tree Protocol)</p> <p>RSTP, IEEE 802.1w (Rapid Spanning Tree Protocol)</p> <p>MSTP, IEEE 802.1s (Multiple Spanning Tree Protocol, Spanning Tree by VLAN)</p> <p>Root Guard</p> <p>BPDU Guard</p>
Link Aggregation	<p>Static trunk</p> <p>IEEE 802.3ad LACP</p> <p>128 trunk groups with 8 ports per trunk</p>
QoS	<p>Traffic classification based, strict priority and WRR</p> <p>8-level priority for switching</p> <ul style="list-style-type: none"> - Port number - 802.1p priority - DSCP/TOS field in IP Packet <p>Policy-based DiffServ</p>
Multicast	<p>IGMP snooping v1/v2/v3</p> <p>IGMP proxy</p> <p>IGMP querier mode</p> <p>MLD snooping v1/v2</p>
Access Control List	<p>Supports standard and expanded ACL</p> <p>IP-based ACL/MAC-based ACL</p> <p>Time-based ACL</p> <p>ACL pool can be used for QoS classification</p> <p>Up to 1K entries</p>
Security	<p>Supports MAC+ port binding</p> <p>IPv4/IPv6 + MAC+ port binding</p> <p>IPv4/IPv6 + port binding</p> <p>Supports MAC filter</p> <p>ARP spoofing prevention</p> <p>ARP scanning prevention</p> <p>IP source guard</p>
Authentication	<p>IEEE 802.1x Port-based network access control</p>

	AAA Authentication: IPv4/IPv6 over RADIUS
SNMP MIBs	<p>RFC-1213 MIB-II</p> <p>IF-MIB</p> <p>RFC-1493 Bridge MIB</p> <p>RFC-1643 Ethernet MIB</p> <p>RFC-2863 Interface MIB</p> <p>RFC-2665 Ether-Like MIB</p> <p>RFC-2674 Extended Bridge MIB</p> <p>RFC-2819 RMON MIB (Group 1, 2, 3 and 9)</p> <p>RFC-2737 Entity MIB</p> <p>RFC-2618 RADIUS Client MIB</p> <p>RFC-2933 IGMP-STD-MIB</p> <p>RFC3411 SNMP-Frameworks-MIB</p> <p>IEEE802.1X PAE</p> <p>LLDP</p> <p>MAU-MIB</p>
Management Functions	
System Configuration	Console, Telnet, SSH, Web Browser, SSL, SNMPv1, v2c and v3
Management Interface	<p>IPv4/IPv6 HTTP, SSL, SNMP, FTP/TFTP, NTP, SSH</p> <p>Telnet, CLI</p> <p>RADIUS, TACACS+</p> <p>RMOM 1,2,3,9 for group</p> <p>SNMP MTB and trap</p>
Standards Conformance	
Regulatory Compliance	FCC Part 15 Class A, CE
Standards Compliance	<p>IEEE 802.3 10BASE-T</p> <p>IEEE 802.3u 100BASE-TX/100BASE-FX</p> <p>IEEE 802.3z 1000BASE-SX/LX</p> <p>IEEE 802.3ab Gigabit 1000T</p> <p>IEEE 802.3ae 10Gigabit Ethernet</p> <p>IEEE 802.3x Flow Control and Back Pressure</p> <p>IEEE 802.3ad Port Trunk with LACP</p> <p>IEEE 802.1d Spanning Tree protocol</p> <p>IEEE 802.1w Rapid Spanning Tree Protocol</p> <p>IEEE 802.1s Multiple Spanning Tree Protocol</p> <p>IEEE 802.1p Class of Service</p> <p>IEEE 802.1Q VLAN tagging</p> <p>IEEE 802.1x Port Authentication Network Control</p> <p>IEEE 802.1ab LLDP</p>
Environment	

Operating	Temperature: 0 ~ 50 degrees C Relative Humidity: 10 ~ 90% (non-condensing)
Storage	Temperature: -10 ~ 70 degrees C Relative Humidity: 5 ~ 90% (non-condensing)

1.4.2 Management Module Specification

XGS3-42000R Hardware Version 2 Management Module	
Model Name	
Product	XGS3-M16C8S
Hardware Specifications	
Copper Ports	16 x 10/100/1000BASE-T RJ45 ports
SFP/mini-GBIC Slots	24 x 100/1000BASE-SX/LX SFP slots
Switch Fabric	48Gbps
Throughput	71.42Mpps@64bytes
LED	System: PWR, RUN, Master, FAN TP Ports: 10/100/1000M LNK/ACT SFP Ports: 100/1000M LNK/ACT
IPv4 Layer 3 functions	
IP Routing Protocol	Static Route, RIPv1/v2, OSPFv2, BGP4 Policy-based Routing (PBR) LPM Routing (MD5 authentication)
Multicast Routing Protocol	IGMP v1 / 2 / 3, DVMRP, PIM-DM/SM, PIM-SSM
Layer 3 Protocol	VRRP, ARP, ARP Proxy
Routing Interface	Per VLAN
IPv6 Layer 3 functions	
IP Routing Protocol	RIPng, OSPFv3, BGP4+
Multicast Routing Protocol	PIM-SM/DM for IPv6 MLD for IPv6 (v1) MLDv1/v2 MLD Snooping, 6 to 4 Tunnels Multicast receive control Illegal multicast source detect
Layer 3 Protocol	Configured Tunnels , ISATAP, CIDR
Layer 2 functions	
Port Configuration	Port disable/enable. Auto-negotiation 10/100/1000Mbps full and half duplex mode selection. Bandwidth control on each port

	Port Loopback detect
VLAN	802.1Q Tagged Based VLAN ,up to 4K VLAN groups Q-in-Q GVRP Private VLAN
Spanning Tree Protocol	STP, IEEE 802.1d (Spanning Tree Protocol) RSTP, IEEE 802.1w (Rapid Spanning Tree Protocol) MSTP, IEEE 802.1s (Multiple Spanning Tree Protocol, spanning tree by VLAN) Root Guard BPDU Guard
Link Aggregation	Static Trunk IEEE 802.3ad LACP Support 8 groups of 8-Port trunk support
QoS	Traffic classification based, Strict priority and WRR 8-level priority for switching - Port Number - 802.1p priority - DSCP/TOS field in IP Packet Policy-based DiffServ
Multicast	IGMP v1 / v2 / v3 Snooping IGMP Proxy IGMP Querier mode support MLDv1 / v2, MLD v1/v2 Snooping
Access Control List	Supports Standard and Expanded ACL IP-based ACL / MAC-based ACL Time-based ACL ACL Pool can be used for QoS classification Up to 1K entries
Security	Support MAC+ port binding IPv4 / IPv6 + MAC+ port binding IPv4 / IPv6 + port binding Support MAC filter ARP Spoofing Prevention ARP Scanning Prevention IP Source Guard
Authentication	IEEE 802.1x Port-based network access control AAA Authentication: IPv4 / IPv6 over RADIUS
SNMP MIBs	RFC-1213 MIB-II IF-MIB RFC-1493 Bridge MIB

	<p>RFC-1643 Ethernet MIB RFC-2863 Interface MIB RFC-2665 Ether-Like MIB RFC-2674 Extended Bridge MIB RFC-2819 RMON MIB (Group 1, 2, 3 and 9) RFC-2737 Entity MIB RFC-2618 RADIUS Client MIB RFC-2933 IGMP-STD-MIB RFC3411 SNMP-Frameworks-MIB IEEE802.1X PAE LLDP MAU-MIB</p>
Management Functions	
System Configuration	Console, Telnet, SSH, Web browser, SSL, SNMPv1, v2c and v3
Management	<p>Supports the unite for IPv4 / IPv6 HTTP and SSL Supports the user IP security inspection for IPv4 / IPv6 SNMP Supports MIB and TRAP Supports IPv4 / IPv6 FTP/TFTP Supports IPv4 / IPv6 NTP Supports RMOM 1, 2, 3, 9 four group Supports the RADIUS authentication for IPv4 / IPv6 telnet user name and password Supports IPv4 / IPv6 SSH The right configuration for users to adopt RADIUS server's shell management Supports the function for timing-reset bases needs Supports CLI, Console (RS-232, Telnet) Supports SNMPv1 / v2c / v3 Supports Security IP safety net management function: avoid unlawful landing in nonrestrictive area. Supports TACACS+</p>
Standards Conformance	
Regulatory Compliance	FCC Part 15 Class A, CE
Standards Compliance	<p>IEEE 802.3 10BASE-T IEEE 802.3u 100BASE-TX IEEE 802.3z 1000BASE-SX/LX IEEE 802.3ab Gigabit 1000T IEEE 802.3ae 10 Gigabit Ethernet IEEE 802.3x flow control and back pressure IEEE 802.3ad port trunk with LACP IEEE 802.1d Spanning Tree protocol IEEE 802.1w Rapid Spanning Tree protocol IEEE 802.1s Multiple Spanning Tree protocol IEEE 802.1p Class of Service IEEE 802.1Q VLAN tagging IEEE 802.1x Port Authentication Network Control IEEE 802.1ab LLDP</p>

1.4.3 Standard Ethernet Module Specifications

XGS3-42000R Hardware Version 2 Standard Ethernet Modules		
Model Name		
Product	XGS3-S16C8S4X	XGS3-S48G
Hardware Specifications		
Copper Ports	16 x 10/100/1000BASE-T RJ45 ports	48 x 10/100/1000BASE-T RJ45 ports
SFP/mini-GBIC Slots	24 x 100/1000BASE-SX/LX SFP slots, shared with Port 1 to Port 16	--
SFP+/mini-GBIC Slots	4 1/10GBASE-SR/LR SFP+ slots	--
Switch Fabric	128Gbps	96Gbps
Throughput	95Mpps@64Bytes	71Mpps@64Bytes
LED	System: PWR, RUN TP Ports: 10/100/1000M LNK/ACT SFP Ports: 100/1000M LNK/ACT SFP+ Ports: 1/10G LNK/ACT	TP Ports: 10/100/1000M LNK/ACT
Standards Compliance	IEEE 802.3 10BASE-T IEEE 802.3u 100BASE-TX/100BASE-FX IEEE 802.3z Gigabit SX/LX IEEE 802.3ab Gigabit 1000T IEEE 802.3ae 10 Gigabit Ethernet	IEEE 802.3 10BASE-T IEEE 802.3u 100BASE-TX IEEE 802.3ab Gigabit 1000T

Chapter 2 INSTALLATION

This section describes the hardware features and installation of the Chassis Switch on the desktop or rack mount. For easier management and control of the Chassis Switch, familiarize yourself with its display indicators and ports. Front panel illustrations in this chapter display the unit LED indicators. Before connecting any network device to the Chassis Switch, please read this chapter completely.

2.1 Hardware Description



The Chassis Switch has a Power Supply Module, and will not have any Management/Standard Ethernet Module on shipment.

Slot 1 should be installed with Management Module before powering on the switch, otherwise the Chassis Switch will not operate normally.

2.1.1 Chassis Switch Hardware Description

The unit front panel provides a simple interface monitoring the XGS3-42000R Chassis Switch. [Figure 2-1-1](#) shows the front panel of the Chassis Switches.

XGS3-42000R Front Panel

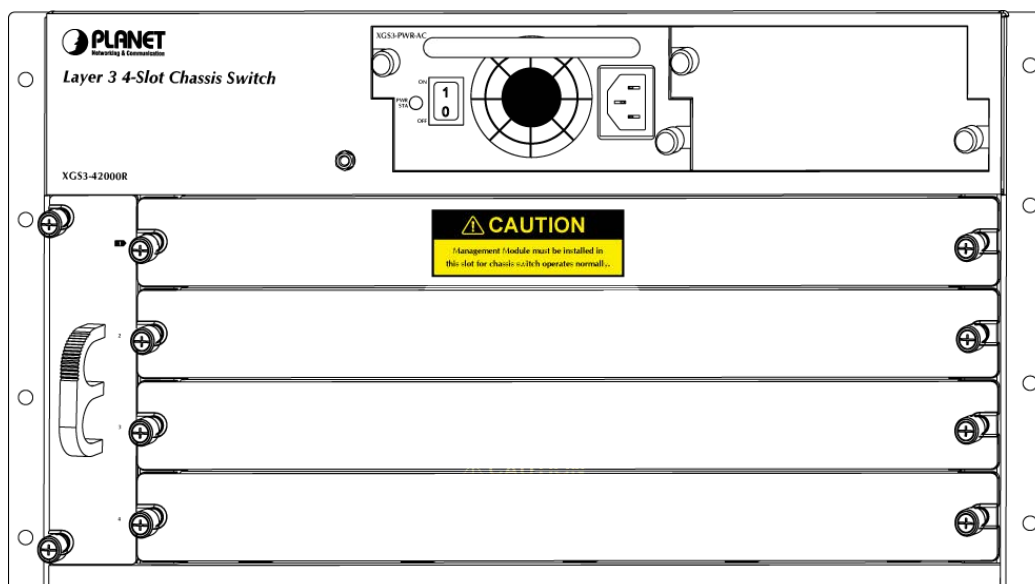

Figure 2-1-1 XGS3-42000R front panel

■ Power slots

Used for system power supply modules, supporting up to two 500W AC modules (XGS3-PWR-AC).

■ Management slots

Slots 1 & 2 support management module like XGS3-M16C8S.

■ Standard slots

Slots 2~4 support standard module like XGS3-S16C8S4X and XGS3-S48G.

■ Fan tray slot

Supports one system fan assembly, each assembly consists of four axial fans.

The unit rear panel provides a simple interface monitoring the XGS3-42000R Chassis Switch. [Figure 2-1-2](#) shows the rear panel of the Chassis Switches.

XGS3-42000R Rear Panel

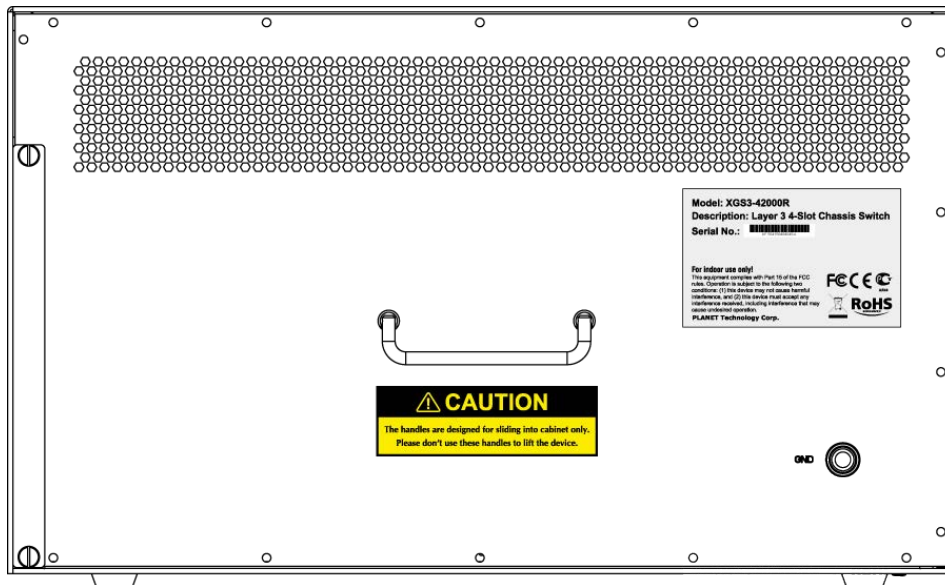

Figure 2-1-2 XGS3-42000R rear panel

■ Power Sockets

For compatibility with electric service in most areas of the world, the Chassis Switch's power supply automatically adjusts to line power in the range 100-240VAC and 50/60 Hz.

■ Dust gauze slot

Exterior air inlet for the ventilation subsystem.

2.1.2 Management Module Hardware Description

The unit front panel provides a simple interface monitoring the XGS3-M16C8S Management Module. [Figure 2-1-3](#) shows the front panel of the Management Module.

XGS3-M16C8S Front Panel



Figure 2-1-3 XGS3-M16C8S front panel

➤ **Gigabit TP Interface**

10/100/1000BASE-T Copper, RJ45 twisted-pair: Up to 100 meters.

➤ **Gigabit SFP Slots**

100/1000BASE-SX/LX mini-GBIC slot, SFP (Small Form Factor Pluggable) transceiver module: From 550 meters (Multi-mode fiber) to 10/30/50/70/120 kilometers (single-mode fiber).

➤ **Console Port**

The console port is a RJ45 type, RS-232 male serial port connector. It is an interface for connecting a terminal directly. Through the console port, it provides rich diagnostic information includes IP Address setting, factory reset, port management, link status and system setting. Users can use the attached RS-232 cable in the package and connect to the console port on the device.

Property	Specification
Connector	RJ45 (receptacle), connects to character terminals
Connector type	RS-232, connects to PC serial port and running terminal emulator on PC
Baud rate	9600bps (default)

➤ **USB Interface**

The USB port is a USB2.0 type, an interface for uploading/restoring the configuration/firmware.

➤ **Alarm Port**

The Alarm port is an RJ45 type, an interface for monitoring the external devices (such as alarm) when monitoring external devices has failed.

➤ **MGMT Port**

The MGMT port is an RJ45 type, an independent interface for Telnet or SSH.

The front panel LEDs indicate instant status of port links, data activity, system operation, system power, master and system fan, helps monitor and troubleshoot when needed. [Figure 2-1-4](#) shows the front panel of the Management Module.

XGS3-M%7, G LED indication



Figure 2-1-4 XGS3-M16C8S LED panel

➤ System

LED	Color	Function
PWR	Green	Lights to indicate that Management Module has power.
	Off	To indicate the Management Module has been powered off.
RUN	Green	Blinks slowly to indicate that Management Module is running in normal status. Blinks fast to indicate that system is loading (Management Module booting after hot plug-in).
	Off	Running Status is failure.
Master	Green	Management Module operates in master mode.
	Off	Management Module operates in slave mode.
FAN	Green	Fan works normally.
	Red	Fan works abnormally.
	Off	Fan is off.

➤ 10/100/1000BASE-T interfaces

LED	Color	Function
LNK/ACT	Green	Lights to indicate the link through that port is successfully established with speed 10/100/1000Mbps .
		Blink to indicate that the Management Module is actively sending or receiving data over that port.
	Off	No data goes through the port.

➤ 100/1000BASE-X SFP interfaces

LED	Color	Function
LNK/ACT	Green	Lights to indicate the link through that port is successfully established with speed 100/1000Mbps .
		Blink to indicate that the Management Module is actively sending or receiving data over that port.
	Off	No data goes through the port.

2.1.3 Standard Ethernet Module Hardware Description

The unit front panel provides a simple interface monitoring the XGS3-S16C8S4X Standard Ethernet Module. [Figure 2-1-7](#) shows the front panel of the Standard Ethernet Module.

XGS3-S16C8S4X Front Panel

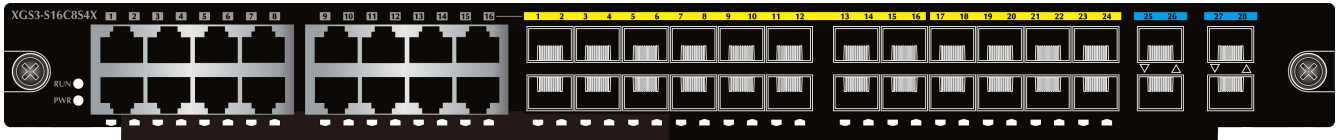

Figure 2-1-7 XGS3-S16C8S4X front panel

- **Gigabit TP interface**
10/100/1000BASE-T Copper, RJ45 twisted-pair: Up to 100 meters.
- **Gigabit SFP slots**
100/1000BASE-SX/LX mini-GBIC slot, SFP (Small Form Factor Pluggable) transceiver module: From 550 meters (Multi-mode fiber) to 10/30/50/70/120 kilometers (single-mode fiber).
- **10 Gigabit SFP+ slots**
1/10GBASE-SR/LR mini-GBIC slot, SFP+ (Small Form Factor Pluggable) transceiver module: From 300 meters (Multi-mode fiber) to 10/20/40/60 kilometers (single-mode fiber).

The front panel LEDs indicate instant status of port links, data activity, system operation and system power, and helps monitor and troubleshoot when needed. [Figure 2-1-8](#) shows the front panel of the Standard Ethernet Module.

XGS3-S16C8S4X LED indication



Figure 2-1-8 XGS3-S16C8S4X LED panel

➤ System

LED	Color	Function
PWR	Green	Lights to indicate that Standard Ethernet Module has power.
	Off	To indicate the Standard Ethernet Module has been powered off.
RUN	Green	Blinks slowly to indicate that Standard Ethernet Module is running in normal status. Blinks fast to indicate that system is loading (Standard Module booting after hot plug-in).
	Yellow	Lights to indicate that Standard Ethernet Module has been shut down.
	Red	Lights to indicate that Standard Ethernet Module has failed.
	Off	Standard Ethernet Module is off and can be pulled out.

➤ **10/100/1000BASE-T interfaces**

LED	Color	Function
LNK/ACT	Green	Lights to indicate the link through that port is successfully established with speed 10/100/1000Mbps .
		Blink to indicate that the Standard Ethernet Module is actively sending or receiving data over that port.
	Off	No data goes through the port.

➤ **100/1000BASE-X SFP interfaces**

LED	Color	Function
LNK/ACT	Green	Lights to indicate the link through that port is successfully established with speed 100/1000Mbps .
		Blink to indicate that the Management Module is actively sending or receiving data over that port.
	Off	No data goes through the port.

➤ **1/10GBASE-X SFP+ interfaces**

LED	Color	Function
LNK/ACT	Green	Lights to indicate the link through that port is successfully established with speed 1/10GMbps .
		Blink to indicate that the Management Module is actively sending or receiving data over that port.
	Off	No data goes through the port.

The unit front panel provides a simple interface monitoring the XGS3-S48G Standard Ethernet Module. [Figure 2-1-9](#) shows the front panel of the Standard Ethernet Module.

XGS3-S48G Front Panel

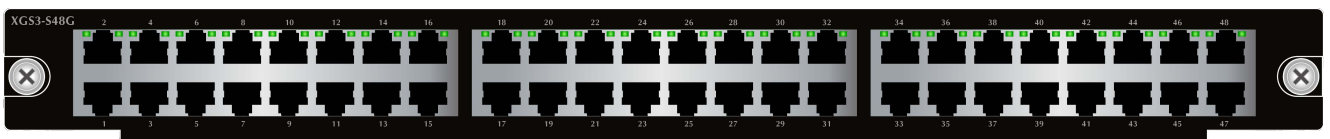

Figure 2-1-9 XGS3-S48G front panel

■ Gigabit TP interface

10/100/1000BASE-T Copper, RJ-45 Twist-Pair: Up to 100 meters.

The front panel LEDs indicate instant status of port links and data activity, and helps monitor and troubleshoot when needed. [Figure 2-1-10](#) shows the front panel of the Standard Ethernet Module.

XGS3-S48G LED indication

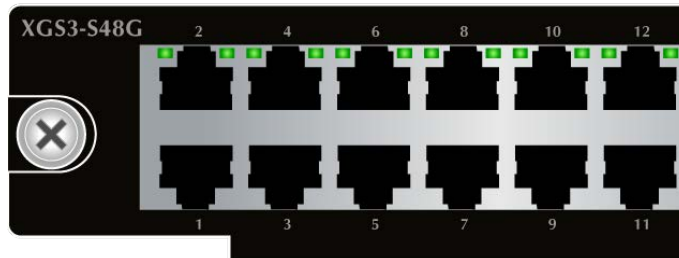

Figure 2-1-10 XGS3-S48G LED panel

■ 10/100/1000BASE-T interfaces

LED	Color	Function
LNK/ACT	Green	To indicate the link through that port is successfully established with speed 10/100/1000Mbps .
	Yellow	To indicate that the Standard Ethernet Module is actively sending or receiving data over that port.
	Off	No data go through the port.

2.1.4 AC Power Supply Module Hardware Description

The unit front panel provides a simple interface monitoring the XGS3-PWR-AC AC Power Supply Module. [Figure 2-1-15](#) shows the front panel of the AC Power Supply Module.

XGS3-PWR-AC Front Panel

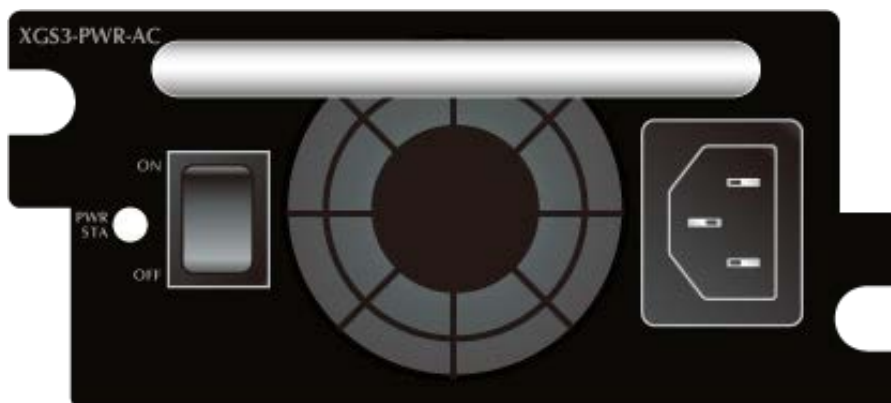

Figure 2-1-15 XGS3-PWR-AC front panel

The front panel LEDs indicate instant status of faulty or good power, and help monitor and troubleshoot when needed. [Figure 2-1-16](#) shows the front panel of the AC Power Supply Module.

XGS3-PWR-AC LED indication



Figure 2-1-16 XGS3-PWR-AC LED panel

■ LED definition - XGS3-PWR-AC :

LED	Color	Function
Power STA	Green	Lights to indicate that the Power Module output status is okay.
	Red	Faulty Power Module or not turning on the output switch,
	Off	The Power Module is working fine or to indicate the Power Module has no output.

2.2 Installing the Chassis Switch

This section describes how to install your Chassis Switch and make connections to the Chassis Switch. Please read the following topics and perform the procedures in the order being presented. To install your Chassis Switch on a desktop or shelf, simply complete the following steps.



During the installation, please take care and avoid crash that may cause damage to the device. As the XGS3-42000R whose full configuration weight is 30kg is heavy, installer is reminded to be careful not to get hurt if it happens to drop. Please make sure the hardware is placed in the rack properly. Check the hardware again after the installation.

2.2.1 Desktop Installation

To install the Chassis Switch on desktop or shelf, please follow these steps:

Step 1: Attach the rubber feet to the recessed areas on the bottom of the Chassis Switch.

Step 2: Place the Chassis Switch on the desktop or the shelf near an AC power source, as shown in [Figure 2-2-1](#).

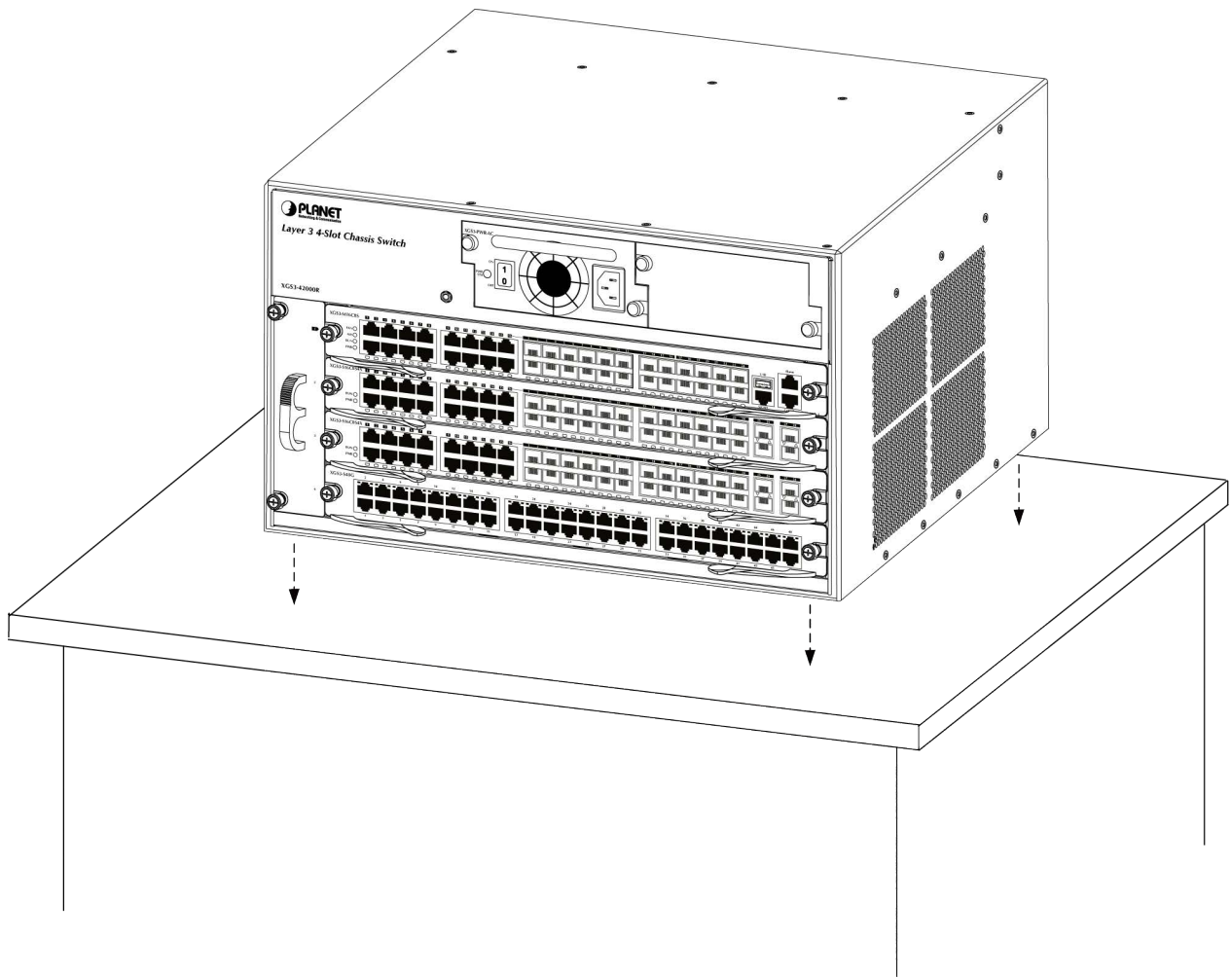

Figure 2-2-1 Place the Chassis Switch on the desktop

Step 3: Keep enough ventilation space between the Chassis Switch and the surrounding objects.



When choosing a location, please keep in mind the environmental restrictions discussed in Chapter 1, Section 4, and Specification.

Step 4: Supply power to the Chassis Switch.

Connect one end of the power cable to the Chassis Switch.

Connect the power plug of the power cable to a standard wall outlet.

2.2.2 Rack Mounting

To install the Chassis Switch in a 19-inch standard rack, please follow the instructions described below.

Step 1: Place the Chassis Switch on a hard flat surface, with the front panel positioned towards the front side.

Step 2: Attach the rack-mount bracket to each side of the Chassis Switch with supplied screws attached to the package. [Figure 2-2-2](#) shows how to attach brackets to one side of the Chassis Switch.

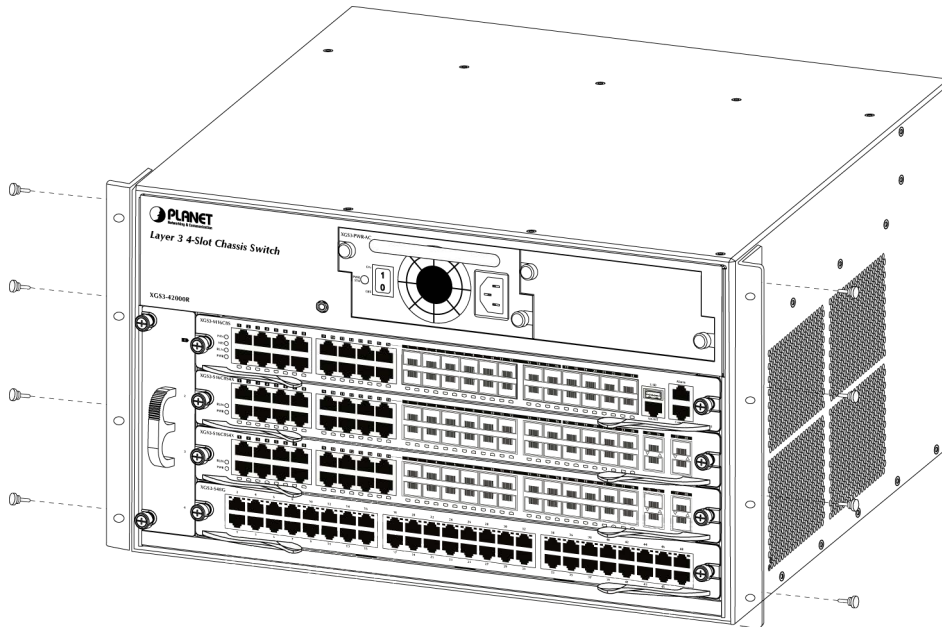

Figure 2-2-2 Attach brackets to the Chassis Switch.



You must use the screws supplied with the mounting brackets. Damage caused to the parts by using incorrect screws would invalidate the warranty.

Step 3: Secure the brackets tightly.

Step 4: Follow the same steps to attach the second bracket to the opposite side.

Step 5: After the brackets are attached to the Chassis Switch, use suitable screws to securely attach the brackets to the rack, as shown in [Figure 2-2-3](#).

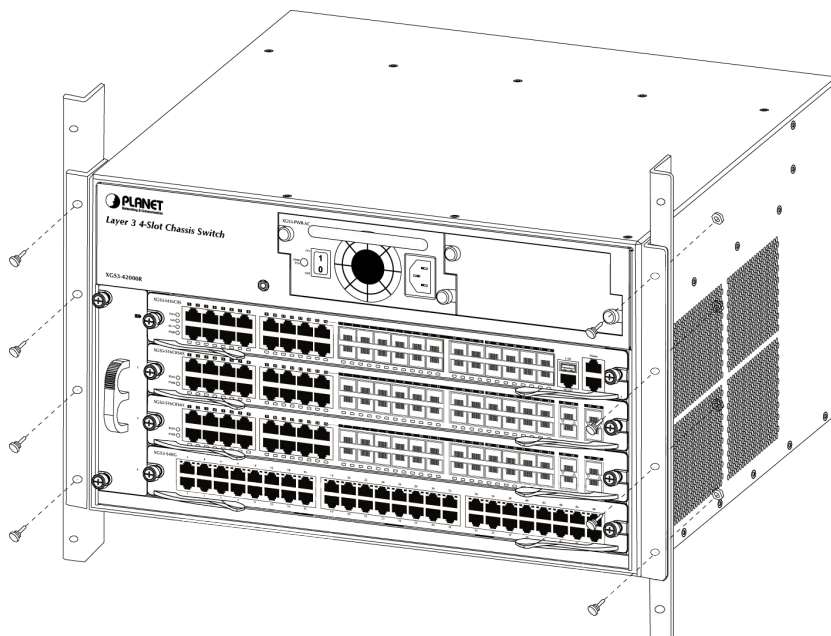

Figure 2-2-3 Mounting Chassis Switch in a Rack



Note

Please take care and avoid crash, that may cause the device damage or any harm to the installer due to the device falling or drop.

The handles are designed for sliding into cabinet only; please don't use handles to lift the Chassis Switch.

Step 6: Proceeds with the steps 4 and steps 5 of session 2.2.1 Desktop Installation to connect the network cabling and supply power to the Chassis Switch.

2.2.3 Chassis Switch Grounding

A good grounding system is the groundwork for the smooth and safe operation of the XGS3-42000R, and an excellent way to prevent lightning strikes and resistance interference. Please follow the XGS3-42000R grounding specification instructions, verify the installation site's grounding condition and ensure proper grounding accordingly.

- **Proper Grounding**

When using an AC power source, the device must be grounded with the green and yellow ground cables; otherwise, shock hazards may occur when insulation resistance between the internal power supply and the chassis degrades.

- **Lightning Protection Grounding**

The lightning protection system is an independent system consisting of a lightning rod, conductor and connection joint with the grounding system. The grounding system usually is shared with the power reference grounding and green and yellow ground cable grounding. Lightning protection grounding is a building requirement, not a specific requirement of the Switch.

- **Electromagnetic Compliance Grounding**

This refers to the grounding to comply with XGS3-42000R electromagnetic compatibility requirements, including shielded grounding, filter grounds, noise, and interference control and level reference. The overall grounding requirements are the sum total of the above. Ground resistance value should be less than 1 ohm.

The XGS3-42000R provides chassis grounding post in the lower rear chassis, marked as "GND". Chassis protection grounding should be properly connected to the rack grounding connector

The ground cabling procedures are listed below:

Step 1: Remove the nuts from the rear chassis grounding posts as shown in [Figure 2-2-4](#).

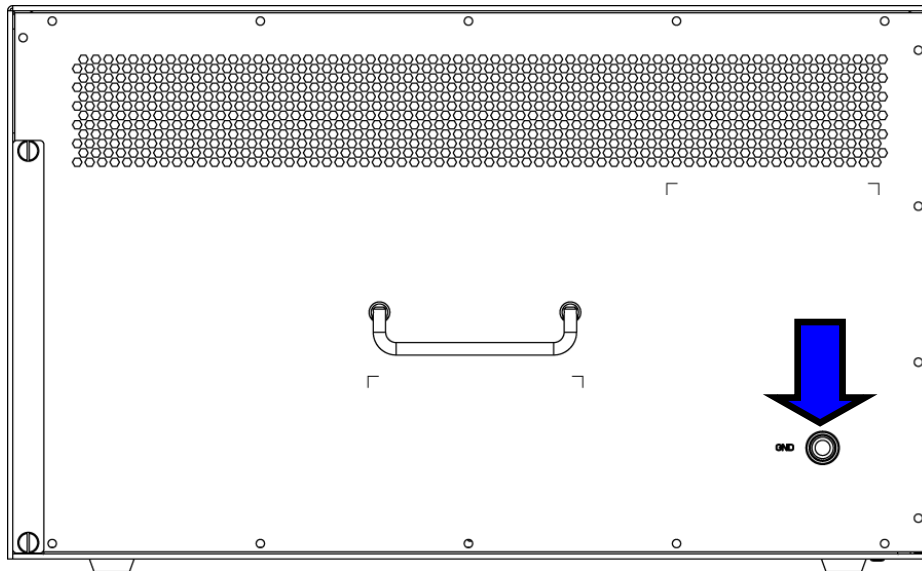

Figure 2-2-4 grounding posts

Step 2: Wrap one end of the green and yellow grounding cable to the grounding posts.

Step 3: Attach the grounding post nut and tighten well.

Step 4: Attach the other end of the grounding cable to the rack grounding connector.



- The grounding cable should be made of a good conductor, and the diameter should be determined by the possible maximum current that may pass through.
- Bare conductor cabling is forbidden.
- Ground resistance value: the combined grounding resistance should be less than 1 ohm.

2.2.4 Installing the Management/Standard Ethernet Module



- Hot-swapping is supported by optional modules for the Chassis Switch. However, for the sake of convenience, it is recommended to power down the Chassis Switch before installing the cards if no module in the switch is running.
- Slot 1 should be installed with management module before powering on the switch, otherwise the Chassis Switch will not operate normally.
- The Chassis Switch supports a maximum of 2 management modules for the purpose of management redundancy at Slot 1 and Slot 2.

The installation procedure is the same for all the cards shown below:

Step 1: Power down the XGS3-42000R.

Step 2: Ensure proper grounding of the XGS3-42000R.

- Step 3:** Put on an ESD wrist strap before contacting with the switch circuit, and make sure the ESD wrist strap is connected securely to the ESD connector in the switch's front panel.
- Step 4:** Loosen the panel fasteners locking back plate counterclockwise and remove the back plate.
- Step 5:** Insert the optional module into the slot; you can use the metal handle on the front plate of the module to ensure good contact. Then lock the module with panel fasteners in the front plate as shown in [Figure 2-2-5](#).

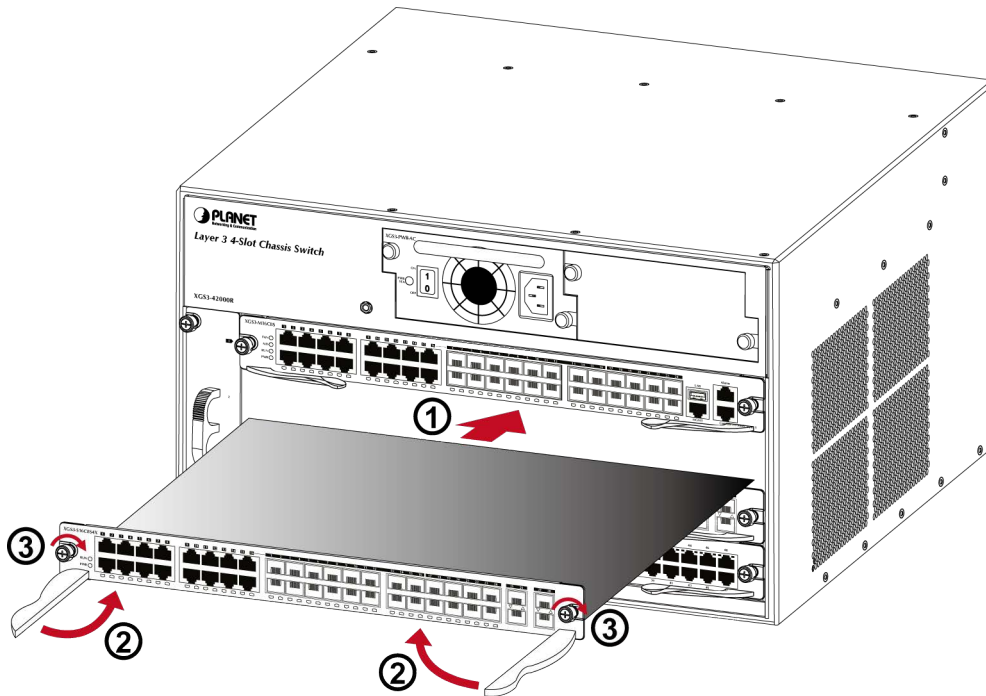

Figure 2-2-5 Insert the optional module into the slot of XGS3-42000R

2.2.5 Removing/Installing the Dust Gauze

Dust gauze is provided in the right section of the XGS3-42000R, which can be installed and removed from the back of the XGS3-42000R. The dust gauze is meant to prevent large debris or particles in the air from being ingested into the switch. Please perform cleaning on a regular basis according to the site conditions.

- Step 1:** Loosen the 2 panel fasteners in the dust gauze.
- Step 2:** Draw the dust gauze out smoothly by holding the 2 screws.
- Step 3:** Clean the dust gauze with a brush (never wash with any liquid).
- Step 4:** Insert the gauze back to its original position in the switch.
- Step 5:** Tighten the panel fasteners.

The installation and removal of the dust gauze is shown below [Figure 2-2-6](#):

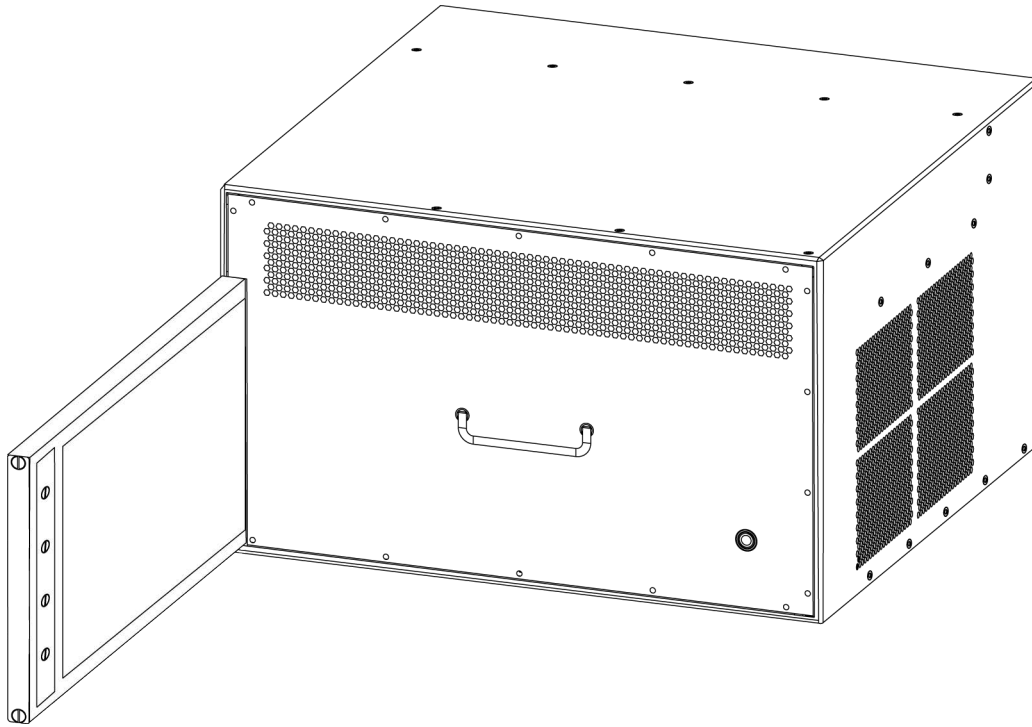

Figure 2-2-6 Installation and Removal of the XGS3-42000R Dust Gauze

2.2.6 Removing/Installing the Fan Tray

One fan tray in the left section of the XGS3-42000R and can be serviced from the front. The installation and removal of the fan tray is relatively simple, please refer to following procedure for reference.

➤ Install the Fan Tray

Step 1: Just hold the fan tray in the correct direction, align with the corresponding slot and push to secure.

Step 2: Tighten the panel fasteners in the front panel.

➤ Remove the Fan Tray

Step 1: Loosen the 2 screws in the front panel of the fan tray.

Step 2: Hold the handle in the front panel of fan tray with your middle and ring fingers, press the locker slightly down, and the fan tray can be drawn out smoothly.

The installation and removal of a fan tray is shown below [Figure 2-2-7](#):

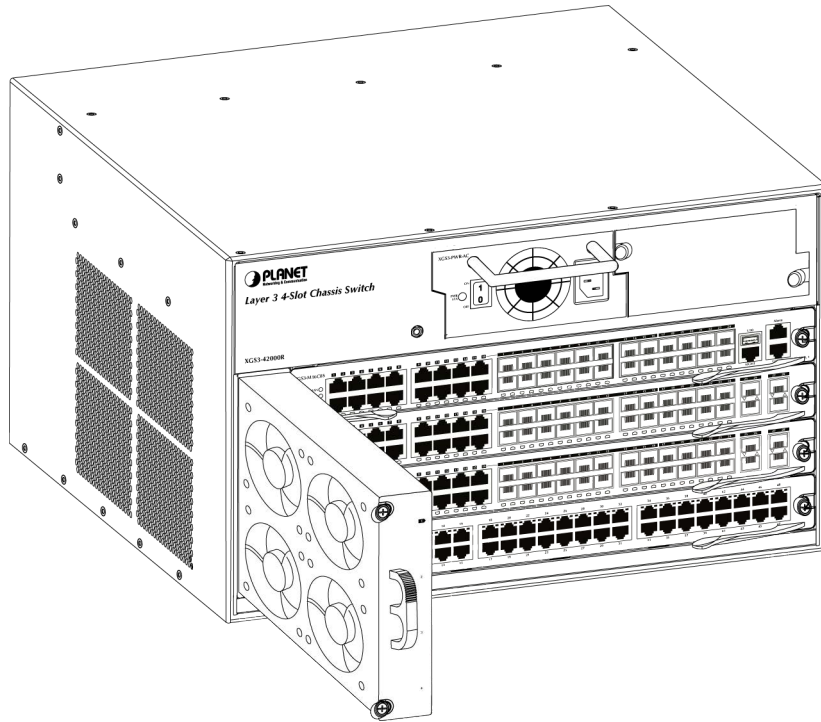

Figure 2-2-7 Installation and Removal the Fan Tray

2.2.7 Removing/Installing the Power Supply Unit

To install a power supply unit into XGS3-42000R, please fasten the hand screw clockwise and slide in the power supply unit into the XGS3-42000R.



Please slid in the PWR-AC module first before plug-in the rear power cord.

To remove a power supply unit out the XGS3-42000R, please loose the hand screw counter clockwise and pull out the power supply unit from the XGS3-42000R.



Please put back the front cover after the PRW-AC module is removed.

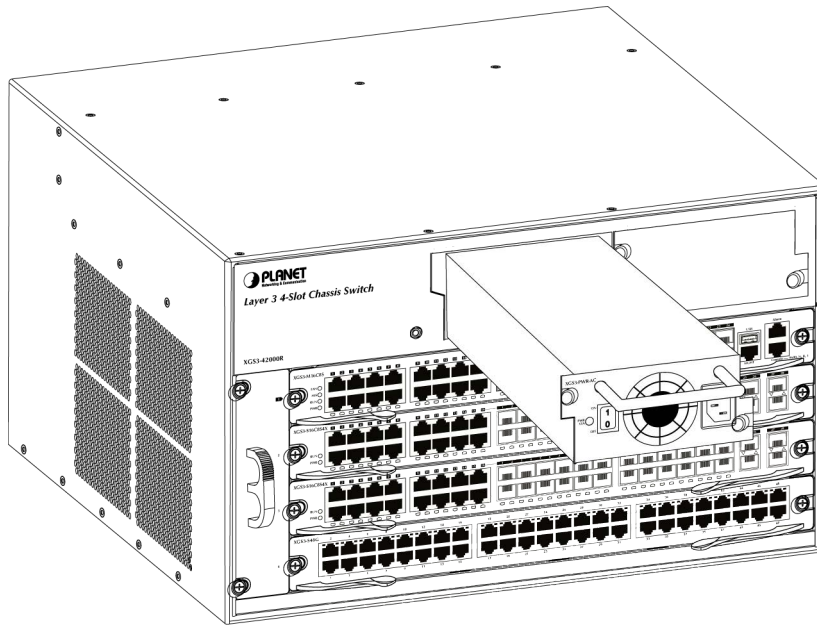

Figure 2-2-8 Install and Removal the Power Supply Unit

2.2.8 Installing the SFP/SFP+ Transceiver

The sections describe how to insert an SFP/SFP transceiver into an SFP/SFP+ slot. The SFP/SFP+ transceivers are hot-pluggable and hot-swappable. You can plug in and out the transceiver to/from any SFP/SFP+ port without having to power down the Chassis Switch as [Figure 2-2-9](#) & [Figure 2-2-10](#) appears.

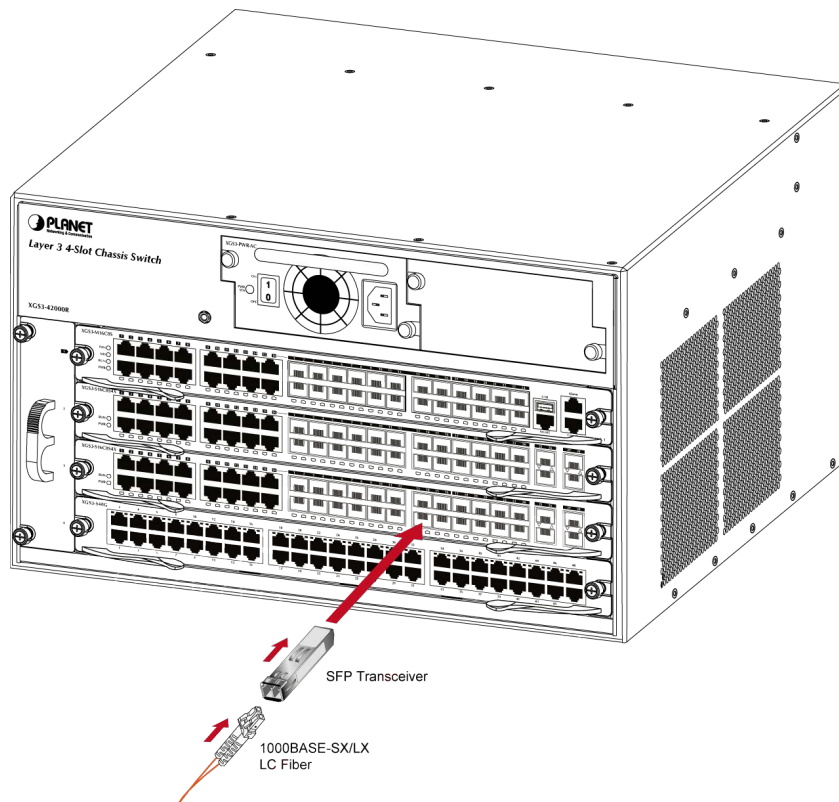

Figure 2-2-9 Plug-in the SFP transceiver

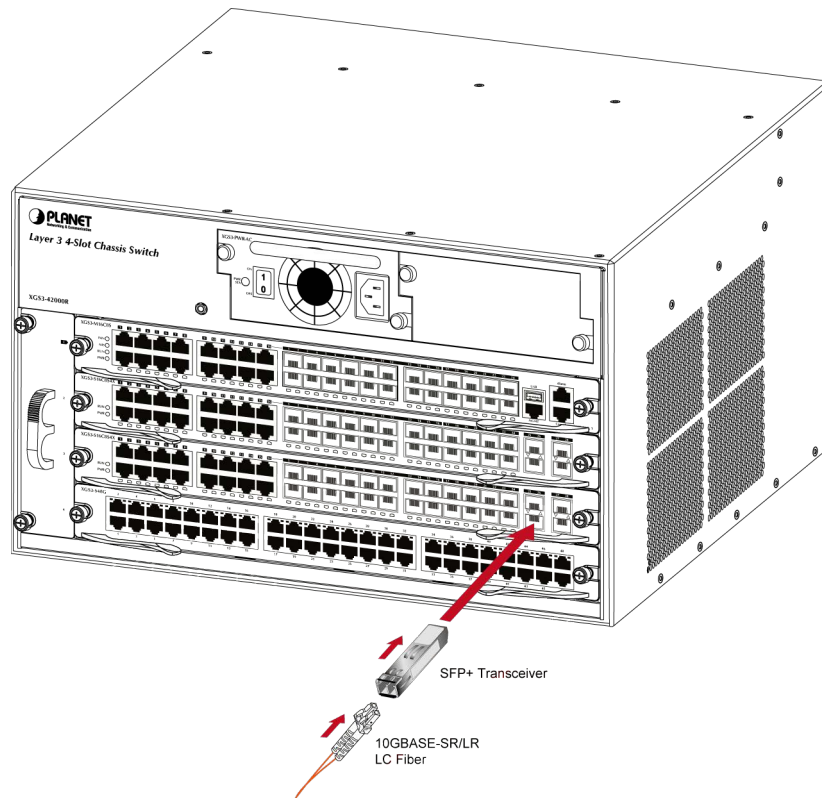

Figure 2-2-10 Plug-in the SFP+ transceiver



It recommends using PLANET SFP/SFP+ transceivers on the Chassis Switch. If you insert a SFP transceiver that is not supported, the Chassis Switch may not recognize it.

Before connect the other Chassis Switches, workstation or Media Converter.

1. Make sure both side of the SFP transceiver are with the same media type, for example: 1000BASE-SX to 1000BASE-SX, 1000BASE-LX to 1000BASE-LX.
2. Check the fiber-optic cable type match the SFP transceiver model.
 - To connect to 1000BASE-SX SFP transceiver, use the Multi-mode fiber cable-with one side must be male duplex LC connector type.
 - To connect to 1000BASE-LX SFP transceiver, use the Single-mode fiber cable-with one side must be male duplex LC connector type.

Before connect the other Chassis Switches, workstation or Media Converter.

1. Make sure both side of the SFP+ transceiver are with the same media type, for example: 10GBASE-SR to 10GBASE-SR, 10GBASE-LR to 10GBASE-LR.
2. Check the fiber-optic cable type match the XFP transceiver model.
 - To connect to 10GBASE-SR SFP+ transceiver, use the Multi-mode fiber cable-with one side must be male duplex LC connector type.
 - To connect to 10GBASE-LR SFP+ transceiver, use the Single-mode fiber cable-with one side must be male duplex LC connector type.

■ **Connect the fiber cable**

1. Attach the duplex LC connector on the network cable into the SFP/SFP+ transceiver.

2. Connect the other end of the cable to a device – switches with SFP/SFP+ installed, fiber NIC on a workstation or a Media Converter.
3. Check the LNK/ACT LED of the SFP/SFP+ slot on the front of the Chassis Switch. Ensure that the SFP/SFP+ transceiver is operating correctly.
4. Check the Link mode of the SFP/SFP+ port if the link failed. Co works with some fiber-NICs, Switch or Media Converters, set the Link mode to “1000 Force”/“10G” is needed.

■ **Remove the transceiver module**

1. Make sure there is no network activity by consult or check with the network administrator. Or through the management interface of the switch/converter (if available) to disable the port in advance.
2. Remove the Fiber Optic Cable gently.
3. Turn the handle of the MGB/MTB module to horizontal.
4. Pull out the module gently through the handle.

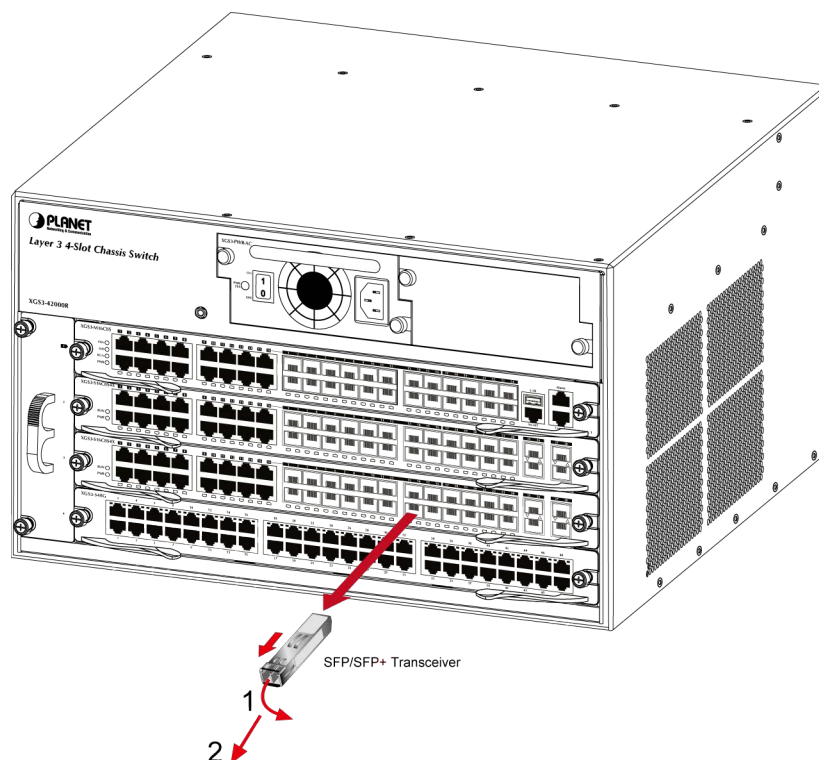

Figure 2-2-11 Pull out the SFP/SFP+ transceiver



Note

Never pull out the module without pull the handle or the push bolts on the module. Direct pull out the module with violent could damage the module and SFP/SFP+ module slot of the Chassis Switch.

Chapter 3 Chassis Switch Management

3.1 Management Options

After purchasing the Chassis Switch, the user needs to configure the Chassis Switch for network management. Chassis Switch provides two management options: in-band management and out-of-band management.

3.1.1 Out-Of-Band Management

Out-of-band management is the management through Console interface. Generally, the user will use out-of-band management for the initial Chassis Switch configuration, or when in-band management is not available. For instance, the user must assign an IP address to the Chassis Switch via the Console interface to be able to access the Chassis Switch through Telnet.

The procedures for managing the Chassis Switch via Console interface are listed below:

Step 1: Setting up the environment:

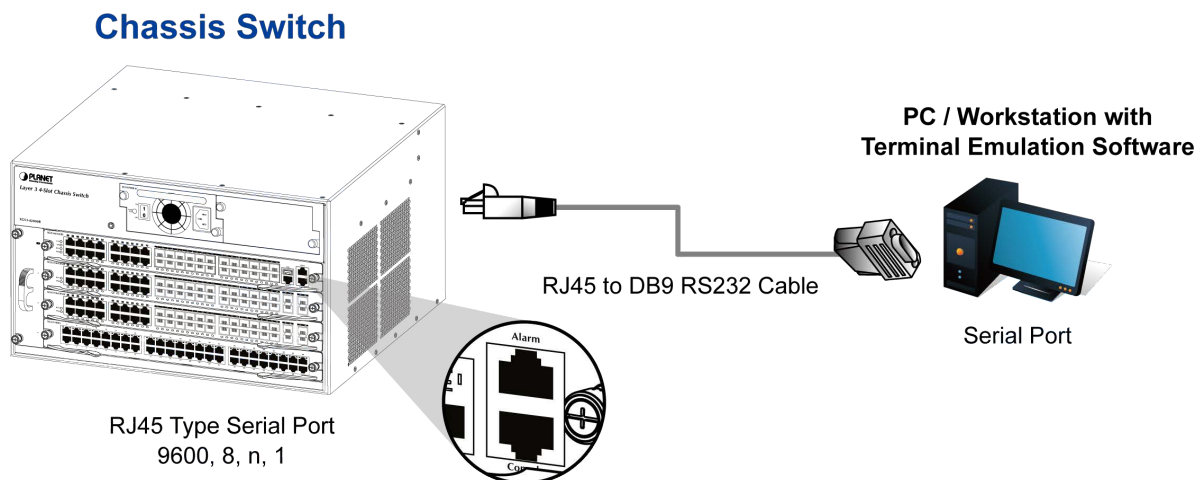

Figure 3-1-1 Out-of-band Management Configuration Environment

As shown in above, the serial port (RS-232) is connected to the Chassis Switch with the serial cable provided. The table below lists all the devices used in the connection.

Device Name	Description
PC machine	Has functional keyboard and RS-232, with terminal emulator installed, such as HyperTerminal included in Windows 7/8/10.
Serial port cable	One end attach to the RS-232 serial port, the other end to the Console port.
Chassis Switch	Functional Console port required.

Step 2 : Entering the HyperTerminal

Open the HyperTerminal included in Windows after the connection established. The example below is based

on the HyperTerminal included in Windows XP.

- 1) Click Start menu - All Programs -Accessories -Communication - **HyperTerminal**.

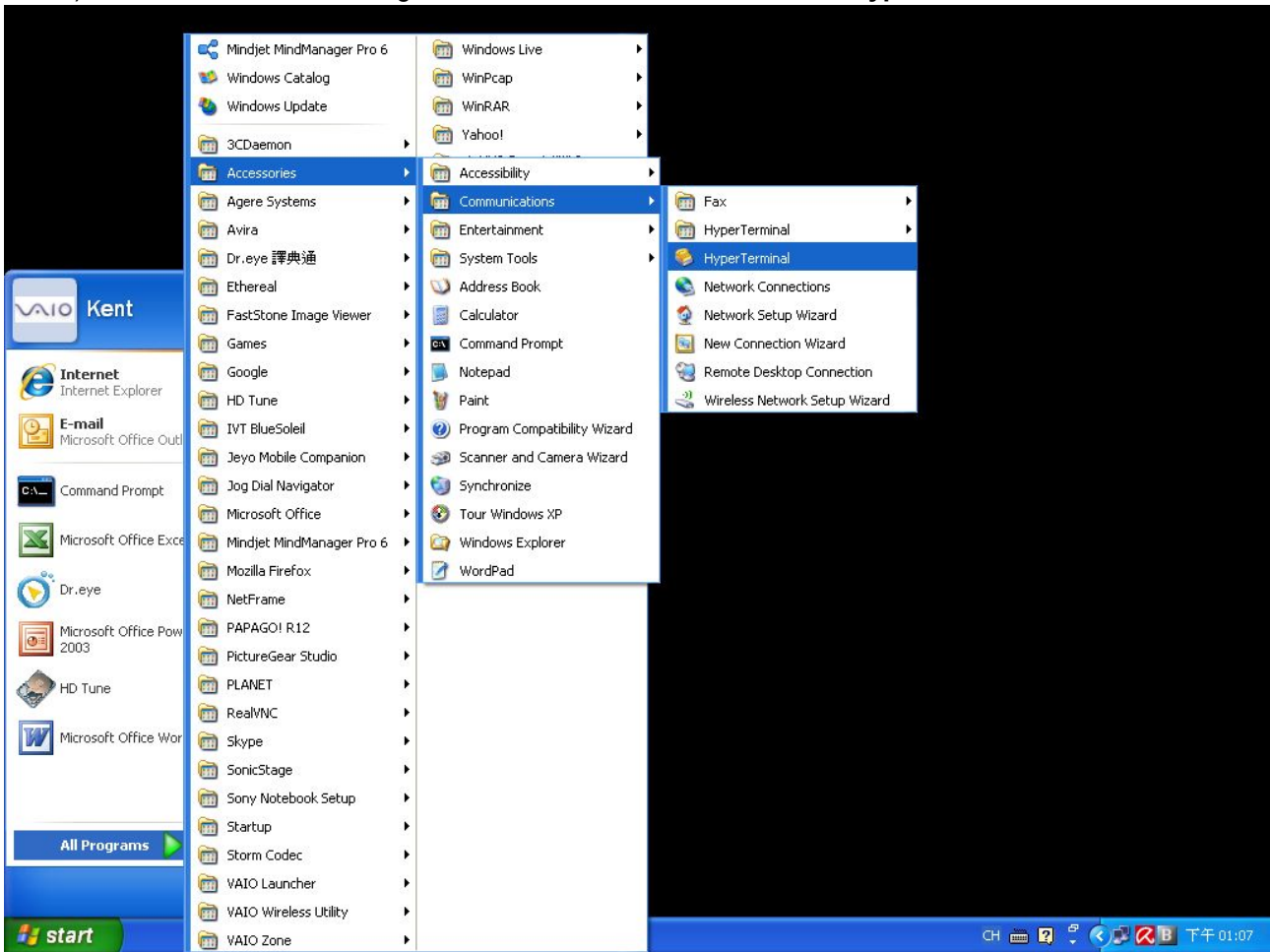

Figure 3-1-2 Opening Hyper Terminal

- 2) Type a name for opening HyperTerminal, such as “Switch”.

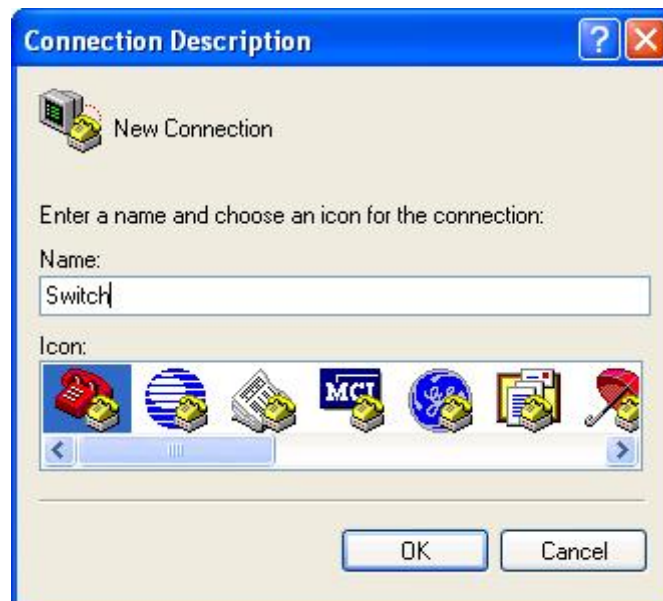

Figure 3-1-3 Opening HyperTerminal

- 3) In the “Connecting using” drop-list, select the RS-232 serial port used by the PC, e.g. COM1, and click “OK”.



Figure 3-1-4 Opening HyperTerminal

4) COM1 property appears, select “9600” for “Baud rate”, “8” for “Data bits”, “none” for “Parity checksum”, “1” for stop bit and “none” for traffic control; or, you can also click “Restore default” and click “OK”.

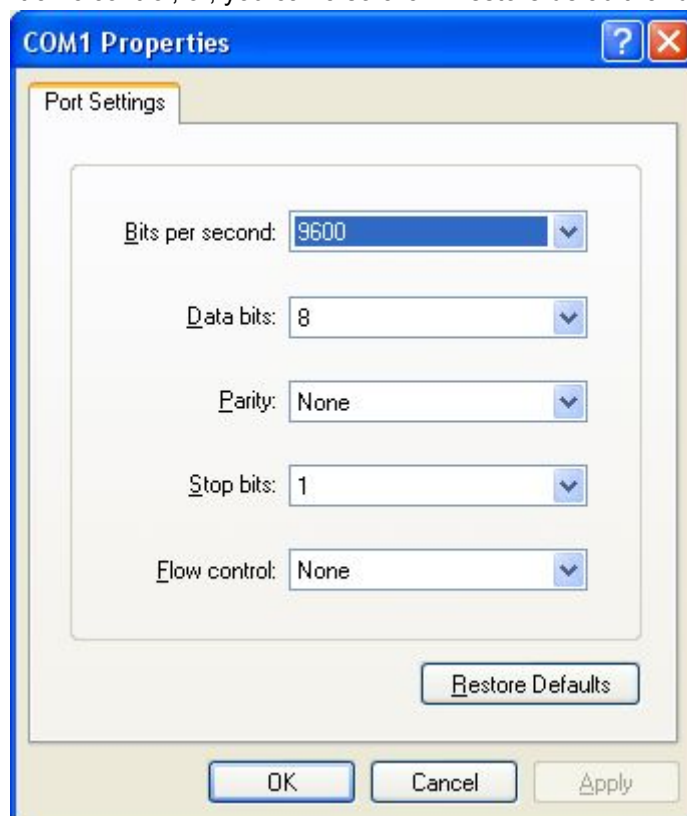

Figure 3-1-5 Opening HyperTerminal

Step 3: Powering the XGS3-4200R Chassis switch

The user can now enter commands to manage the Chassis Switch. For a detailed description for the commands, please refer to the following chapters.

3.1.2 In-band Management

In-band management refers to the management by login to the Chassis Switch using Telnet, or using HTTP, or using SNMP management software to configure the Chassis Switch. In-band management enables management of the Chassis Switch for some devices attached to the Chassis Switch. In the case when in-band management fails due to Chassis Switch configuration changes, out-of-band management can be used for configuring and managing the Chassis Switch.

The XGS3-42000R default IP address is 192.168.0.254

3.1.2.1 Management via Telnet

To manage the Chassis Switch with Telnet, the following conditions should be met:

- 1) Chassis Switch has an IPv4/IPv6 address configured (**Default IP address 192.168.0.254**);
- 2) The host IP address (Telnet client) and the Chassis Switch's VLAN interface IPv4/IPv6 address is in the same network segment;
- 3) If 2) is not met, Telnet client can connect to an IPv4/IPv6 address of the Chassis Switch via other devices, such as a router.

The Chassis Switch is Layer 3 Chassis Switch that can be configured with several IPv4/IPv6 addresses. The following example assumes the shipment status of the Chassis Switch where only VLAN1 exists in the system. The following describes the steps for a Telnet client to connect to the Chassis Switch's VLAN1 interface by Telnet (with IPv4 address example):

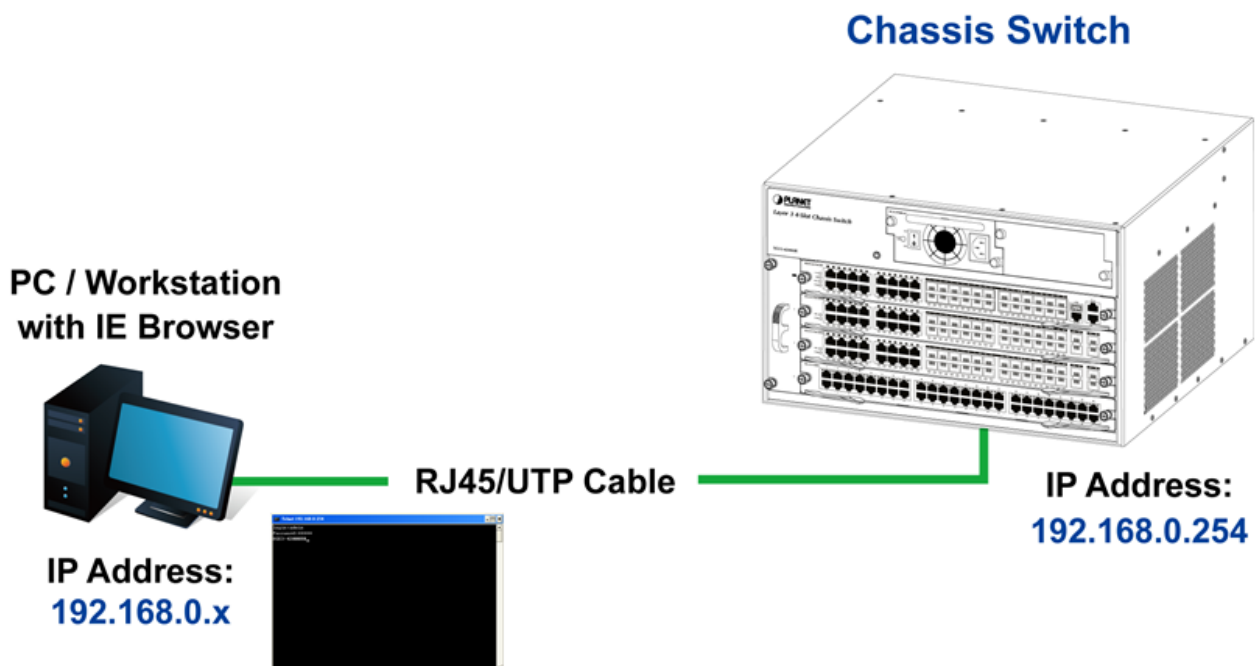

Figure 3-1-6 Manage the Chassis Switch by Telnet

Step 1: Run Telnet Client program.

Run Telnet client program included in Windows with the specified Telnet target.

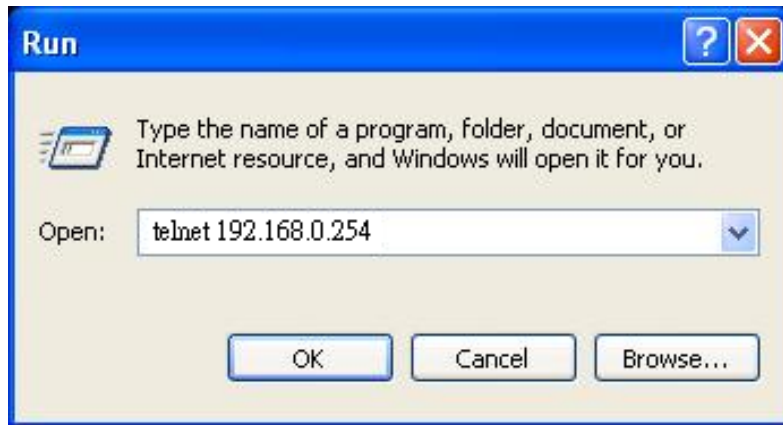

Figure 3-1-7 Run telnet client program included in Windows

Step 2: Login to the Chassis Switch.

Login to the Telnet configuration interface. Valid login name and password are required, otherwise the Chassis Switch will reject Telnet access.

Default IP Address: **192.168.0.254**
Username: **admin**
Password: **admin**

Enter valid login name and password in the Telnet configuration interface, Telnet user will be able to enter the switch's CLI configuration interface. The commands used in the Telnet CLI interface after login is the same as that in the Console interface.

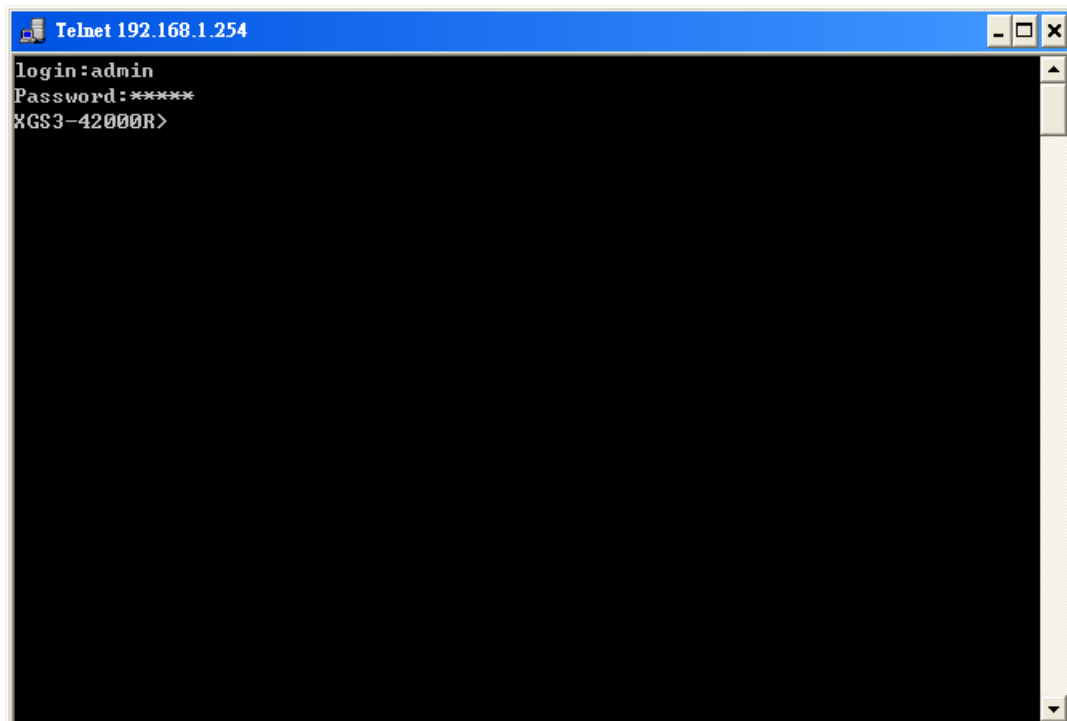

Figure 3-1-8 Telnet Configuration Interface

3.1.2.2 Management via HTTP

To manage the Chassis Switch via HTTP, the following conditions should be met:

- 1) Chassis Switch has an IPv4/IPv6 address configured (**Default IP address 192.168.0.254**);
- 2) The host IPv4/IPv6 address (HTTP client) and the switch's VLAN interface IPv4/IPv6 address are in the same network segment;
- 3) If 2) is not met, HTTP client should connect to an IPv4/IPv6 address of the switch via other devices, such as a router.

Similar to management the Chassis Switch via Telnet, as soon as the host succeeds to ping/ping6 an IPv4/IPv6 address of the Chassis Switch and to type the right login password, it can access the Chassis Switch via HTTP. The configuration list is as below:

Step 1: Use Internet Explorer 8.0 or above Web browser, enter IP address <http://192.168.0.254> (that you have just set in console) to access the Web interface.

Step 2: When the following dialog box appears, please enter the configured user name “admin” and password “admin” (or the username / password you have changed via console). The login screen in [Figure 3-1-9](#) appears.

Default IP Address: **192.168.0.254**
Username: **admin**
Password: **admin**

When accessing a Chassis Switch with IPv6 address, it is recommended to use the Firefox browser with 1.5 or later version. For example, if the IPv6 address of the Chassis Switch is 3ffe:506:1:2::3. Input the IPv6 address of the Chassis Switch is [http://\[3ffe:506:1:2::3\]](http://[3ffe:506:1:2::3]) and the address should draw together with the square brackets.

The Web login interface of XGS3-42000R is as below:

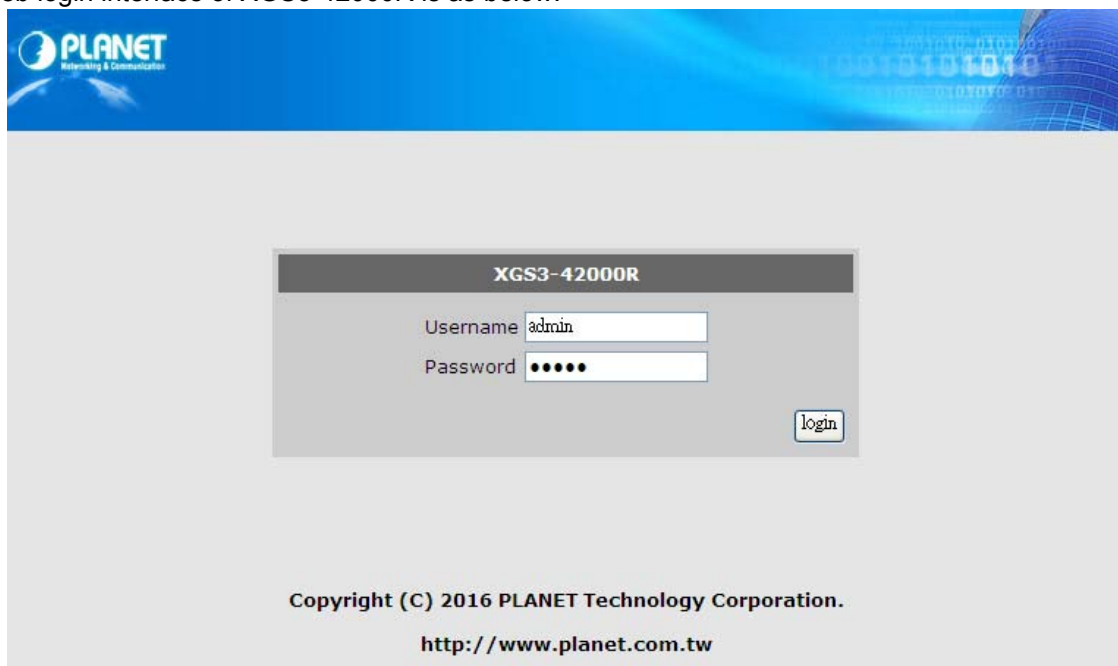

Figure 3-1-9 Web Login Interface

Input the right username and password, and then the main Web configuration interface is shown as below.

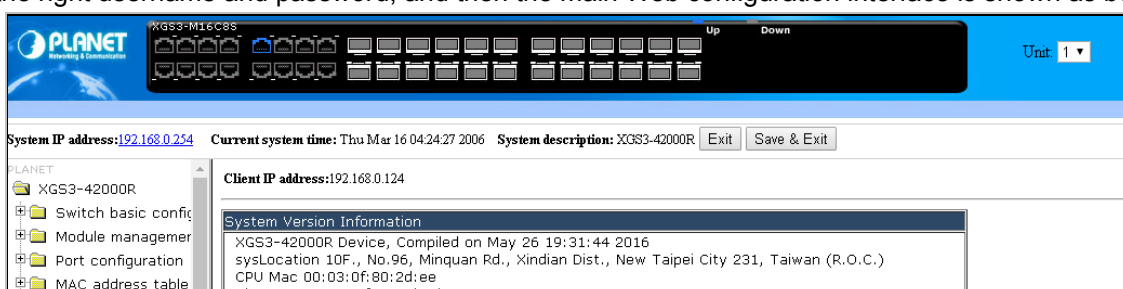

Figure 3-1-10 Main Web Configuration Interface



When configure the Chassis Switch, the name of the Chassis Switch is composed with English letters.

3.1.2.3 Manage the Chassis Switch via SNMP Network Management Software

The necessities required by SNMP network management software to manage Chassis Switches:

- 1) IP addresses are configured on the Chassis Switch;
- 2) The IP address of the client host and that of the VLAN interface on the switch it subordinates to should be in the same segment;
- 3) If 2) is not met, the client should be able to reach an IP address of the Chassis Switch through devices like routers;
- 4) SNMP should be enabled.

The host with SNMP network management software should be able to ping the IP address of the Chassis Switch, so that, when running, SNMP network management software will be able to find it and implement read/write operation on it. Details about how to manage switches via SNMP network management software will not be covered in this manual, please refer to “Snmp network management software user manual”.

3.2 CLI Interface

The Chassis Switch provides three management interfaces for users: CLI (Command Line Interface) interface, Web interface and SNMP network management software. We will introduce the CLI interface and Web configuration interface in details, Web interface is familiar with CLI interface function and will not be covered, please refer to “Snmp network management software user manual”.

CLI interface is familiar to most users. As aforementioned, out-of-band management and Telnet login are all performed through CLI interface to manage the Chassis Switch.

CLI Interface is supported by Shell program, which consists of a set of configuration commands. Those commands are categorized according to their functions in Chassis Switch configuration and management. Each category represents a different configuration mode. The Shell for the switch is described below:

- Configuration Modes
- Configuration Syntax
- Shortcut keys
- Help function
- Input verification
- Fuzzy match support

3.2.1 Configuration Modes

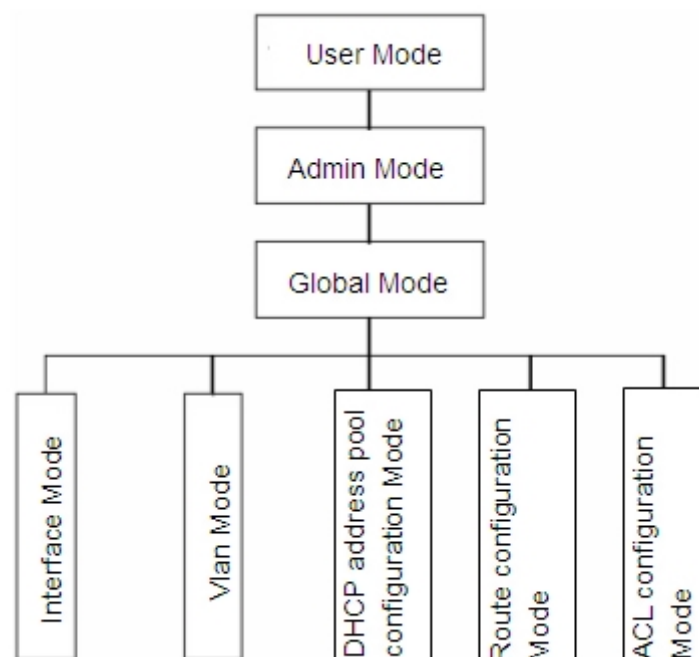

Figure 3-1-12 Shell Configuration Modes

3.2.1.1 User Mode

On entering the CLI interface, entering user entry system first. If as common user, it is defaulted to User Mode. The prompt shown is “**XGS3-42000R>**”, the symbol “>” is the prompt for User Mode. When exit command is run under Admin Mode, it will also return to the User Mode.

Under User Mode, no configuration to the Chassis Switch is allowed, only clock time and version information of the Chassis Switch can be queries.

3.2.1.2 Admin Mode

To Admin Mode sees the following: In user entry system, if as Admin user, it is defaulted to Admin Mode. Admin Mode prompt “**XGS3-42000R#**” can be entered under the User Mode by running the enable command and entering corresponding access levels admin user password, if a password has been set. Or, when exit command is run under Global Mode, it will also return to the Admin Mode. Chassis Switch also provides a

shortcut key sequence "Ctrl+z", this allows an easy way to exit to Admin Mode from any configuration mode (except User Mode).

Under Admin Mode, the user can query the Chassis Switch configuration information, connection status and traffic statistics of all ports; and the user can further enter the Global Mode from Admin Mode to modify all configurations of the Chassis Switch. For this reason, a password must be set for entering Admin mode to prevent unauthorized access and malicious modification to the Chassis Switch.

3.2.1.3 Global Mode

Type the config command under Admin Mode will enter the Global Mode prompt "XGS3-42000R(config)#". Use the exit command under other configuration modes such as Port Mode, VLAN mode will return to Global Mode.

The user can perform global configuration settings under Global Mode, such as MAC Table, Port Mirroring, VLAN creation, IGMP Snooping start and STP, etc. And the user can go further to Port Mode for configuration of all the interfaces.

■ Interface Mode

Use the interface command under Global Mode can enter the interface mode specified. Chassis Switch provides three interface type: 1. VLAN interface; 2. Ethernet port; 3. port-channel, accordingly the three interface configuration modes.

Interface Type	Entry	Operates	Exit
VLAN Interface	Type interface vlan <Vlan-id> command under Global Mode.	Configure switch IPs, etc	Use the exit command to return to Global Mode.
Ethernet Port	Type interface ethernet <interface-list> command under Global Mode.	Configure supported duplex mode, speed, etc. of Ethernet Port.	Use the exit command to return to Global Mode.
port-channel	Type interface port-channel <port-channel-number> command under Global Mode.	Configure port-channel related settings such as duplex mode, speed, etc.	Use the exit command to return to Global Mode.

■ VLAN Mode

Using the **vlan <vlan-id>** command under Global Mode can enter the corresponding VLAN Mode. Under VLAN Mode the user can configure all member ports of the corresponding VLAN. Run the exit command to exit the VLAN Mode to Global Mode.

■ DHCP Address Pool Mode

Type the **ip dhcp pool <name>** command under Global Mode will enter the DHCP Address Pool Mode prompt "XGS3-42000R(config-<name>-dhcp)#". DHCP address pool properties can be configured under DHCP Address Pool Mode. Run the exit command to exit the DHCP Address Pool Mode to Global Mode.

■ Route Mode

Routing Protocol	Entry	Operates	Exit
RIP Routing	Type router rip command	Configure RIP	Use the exit

Protocol	under Global Mode.	protocol parameters.	command to return to Global Mode.
OSPF Routing Protocol	Type router ospf command under Global Mode.	Configure OSPF protocol parameters.	Use the exit command to return to Global Mode.
BGP Routing Protocol	Type router bgp <AS member> command under Global Mode.	Configure BGP protocol parameters.	Use the exit command to return to Global Mode.

■ ACL Mode

ACL type	Entry	Operates	Exit
Standard IP ACL Mode	Type ip access-list standard command under Global Mode.	Configure parameters for Standard IP ACL Mode.	Use the exit command to return to Global Mode.
Extended IP ACL Mode	Type ip access-list extended command under Global Mode.	Configure parameters for Extended IP ACL Mode.	Use the exit command to return to Global Mode.

3.2.2 Configuration Syntax

Chassis Switch provides various configuration commands. Although all the commands are different, they all abide by the syntax for Chassis Switch configuration commands. The general commands format of Chassis Switch is shown below:

```
cmdtxt <variable> {enum1 | ... | enumN } [option1 | ... | optionN]
```

Conventions: **cmdtxt** in bold font indicates a command keyword; <variable> indicates a variable parameter; {enum1 | ... | enumN } indicates a mandatory parameter that should be selected from the parameter set enum1~enumN; and the square bracket ([]) in [option1 | ... | optionN] indicate an optional parameter. There may be combinations of "< >", "{ }" and "[]" in the command line, such as [**<variable>**], {enum1 <variable>| enum2}, [option1 [option2]], etc.

Here are examples for some actual configuration commands:

- show version, no parameters required. This is a command with only a keyword and no parameter, just type in the command to run.
- vlan <vlan-id>, parameter values are required after the keyword.
- firewall {enable | disable}, user can enter firewall enable or firewall disable for this command.
- snmp-server community {ro | rw} <string>, the followings are possible:
snmp-server community ro <string>
snmp-server community rw <string>

3.2.3 Shortcut Key Support

Chassis Switch provides several shortcut keys to facilitate user configuration, such as up, down, left, right and Blank Space. If the terminal does not recognize Up and Down keys, **ctrl +p** and **ctrl +n** can be used instead.

Key(s)	Function	
Back Space	Delete a character before the cursor, and the cursor moves back.	
Up “↑”	Show previous command entered. Up to ten recently entered commands can be shown.	
Down “↓”	Show next command entered. When use the Up key to get previously entered commands, you can use the Down key to return to the next command	
Left “←”	The cursor moves one character to the left.	You can use the Left and Right key to modify an entered command.
Right “→”	The cursor moves one character to the right.	
Ctrl +p	The same as Up key “↑”.	
Ctrl +n	The same as Down key “↓”.	
Ctrl +b	The same as Left key “←”.	
Ctrl +f	The same as Right key “→”.	
Ctrl +z	Return to the Admin Mode directly from the other configuration modes (except User Mode).	
Ctrl +c	Break the ongoing command process, such as ping or other command execution.	
Tab	When a string for a command or keyword is entered, the Tab can be used to complete the command or keyword if there is no conflict.	

3.2.4 Help Function

There are two ways in Chassis Switch for the user to access help information: the “help” command and the “?”.

Access to Help	Usage and function
Help	Under any command line prompt, type in “help” and press Enter will get a brief description of the associated help system.
“?”	<ol style="list-style-type: none"> 1 · Under any command line prompt, enter “?” to get a command list of the current mode and related brief description. 2 · Enter a “?” after the command keyword with a embedded space. If the position should be a parameter, a description of that parameter type, scope, etc, will be returned; if the position should be a keyword, then a set of keywords with brief description will be returned; if the output is “<cr>”, then the command is complete, press Enter to run the command. 3 · A “?” immediately following a string. This will display all the commands that begin with that string.

3.2.5 Input Verification

3.2.5.1 Returned Information: success

All commands entered through keyboards undergo syntax check by the Shell. Nothing will be returned if the user entered a correct command under corresponding modes and the execution is successful.

Returned Information: error

Output error message	Explanation
Unrecognized command or illegal parameter!	The entered command does not exist, or there is error in parameter scope, type or format.
Ambiguous command	At least two interpretations is possible basing on the current input.
Invalid command or parameter	The command is recognized, but no valid parameter record is found.
This command is not exist in current mode	The command is recognized, but this command can not be used under current mode.
Please configure precursor command "" at first!	The command is recognized, but the prerequisite command has not been configured.
syntax error : missing "" before the end of command line!	Quotation marks are not used in pairs.

3.2.6 Fuzzy Match Support

Chassis Switch shell support fuzzy match in searching command and keyword. Shell will recognize commands or keywords correctly if the entered string causes no conflict.

For example:

- 1) For command "show interfaces status ethernet1/1", typing "sh in status ethernet1/1" will work.
- 2) However, for command "show running-config", the system will report a "> Ambiguous command!" error if only "show r" is entered, as Shell is unable to tell whether it is "show run" or "show running-config". Therefore, Shell will only recognize the command if "sh ru" is entered.

Chapter 4 Basic Chassis Switch Configuration

4.1 Basic Configuration

Basic Chassis Switch configuration includes commands for entering and exiting the admin mode, commands for entering and exiting interface mode, for configuring and displaying the Chassis Switch clock, for displaying the version information of the Chassis Switch system, etc.

Command	Explanation
Normal User Mode/ Admin Mode	
enable disable	The User uses enable command to step into admin mode from normal user mode. The disable command is for exiting admin mode.
Admin Mode	
config [terminal]	Enter global mode from admin mode.
Various Modes	
exit	Exit current mode and enter previous mode, such as using this command in global mode to go back to admin mode, and back to normal user mode from admin mode.
Except User Mode/ Admin Mode	
end	Quit current mode and return to Admin mode when not at User Mode/ Admin Mode.
Admin Mode	
clock set <HH:MM:SS> [YYYY.MM.DD]	Set system date and time.
show version	Display version information of the Chassis Switch.
set default	Restore to the factory default.
write	Save current configuration parameters to Flash Memory.
reload	Hot reset the Chassis Switch.

4.2 Telnet Management

4.2.1 Telnet

4.2.1.1 Introduction to Telnet

Telnet is a simple remote terminal protocol for remote login. Using Telnet, the user can login to a remote host with its IP address or hostname from his own workstation. Telnet can send the user's keystrokes to the remote host and send the remote host output to the user's screen through TCP connection. This is a transparent service, as to the user, the keyboard and monitor seems to be connected to the remote host directly.

Telnet employs the Client-Server mode, the local system is the Telnet client and the remote host is the Telnet server. Chassis Switch can be either the Telnet Server or the Telnet client.

When Chassis Switch is used as the Telnet server, the user can use the Telnet client program included in Windows or the other operation systems to login to Chassis Switch, as described earlier in the In-band management section. As a Telnet server, Chassis Switch allows up to 5 telnet client TCP connections.

And as Telnet client, using telnet command under Admin Mode allows the user to login to the other remote hosts. Chassis Switch can only establish TCP connection to one remote host. If a connection to another remote host is desired, the current TCP connection must be dropped.

4.2.1.2 Telnet Configuration Task List

1. Configuring Telnet Server
2. Telnet to a remote host from the Chassis Switch.

1. Configuration of Telnet Server

Command	Explanation
Global Mode	
telnet-server enable no telnet-server enable	Enable the Telnet server function in the Chassis Switch: the " no telnet-server enable " command disables the Telnet function.
username <user-name> [privilege <privilege>] [password {0 7} <password>] no username <username>	Configure user name and password of the telnet. The no form command deletes the telnet user authorization.
authentication securityip <ip-addr> no authentication securityip <ip-addr>	Configure the secure IP address to login to the switch through Telnet: the no command deletes the authorized Telnet secure address.
authentication securityipv6 <ipv6-addr> no authentication securityipv6 <ipv6-addr>	Configure the secure IPv6 address to login to the Chassis Switch through Telnet: the no command deletes the authorized Telnet secure address.
authentication ip access-class	Binding standard IP ACL protocol to login with

{<num-std> <name>} no authentication ip access-class	Telnet/SSH/Web; the no form command will cancel the binding ACL.
authentication ipv6 access-class {<num-std> <name>} no authentication ipv6 access-class	Binding standard IPv6 ACL protocol to login with Telnet/SSH/Web; the no form command will cancel the binding ACL.
authentication line {console vty web} login {local radius tacacs } no authentication line {console vty web} login	Configure telnet authentication mode.
Admin Mode	
terminal monitor terminal no monitor	Display debug information for Telnet client login to the Chassis Switch; the no command disables the debug information.

2. Telnet to a remote host from the Chassis Switch

Command	Explanation
Admin Mode	
telnet {<ip-addr> <ipv6-addr> /host <hostname>} [<port>]	Login to a remote host with the Telnet client included in the Chassis Switch.

4.2.2 SSH

4.2.2.1 Introduction to SSH

SSH (Secure Shell) is a protocol which ensures a secure remote access connection to network devices. It is based on the reliable TCP/IP protocol. By conducting the mechanism such as key distribution, authentication and encryption between SSH server and SSH client, a secure connection is established. The information transferred on this connection is protected from being intercepted and decrypted. The Chassis Switch meets the requirements of SSH2.0. It supports SSH2.0 client software such as SSH Secure Client and putty. Users can run the above software to manage the Chassis Switch remotely.

The Chassis Switch presently supports **RSA authentication**, **3DES cryptography** protocol and SSH user password authentication etc.

4.2.2.2 SSH Server Configuration Task List

SSH Server Configuration

Command	Explanation
Global Mode	

ssh-server enable no ssh-server enable	Enable SSH function on the Chassis Switch; the “ no ssh-server enable ” command disables SSH function.
ssh-user <user-name> password {0 7} <password> no ssh-user <user-name>	Configure the username and password of SSH client software for logging on the Chassis Switch; the “ no ssh-user <user-name> ” command deletes the username.
ssh-server timeout <timeout> no ssh-server timeout	Configure timeout value for SSH authentication; the “ no ssh-server timeout ” command restores the default timeout value for SSH authentication.
ssh-server authentication-retries <authentication-retries> no ssh-server authentication-retries	Configure the number of times for retrying SSH authentication; the “ no ssh-server authentication-retries ” command restores the default number of times for retrying SSH authentication.
ssh-server host-key create rsa modulus <moduls>	Generate the new RSA host key on the SSH server.
Admin Mode	
terminal monitor terminal no monitor	Display SSH debug information on the SSH client side; the “ no terminal monitor ” command stops displaying SSH debug information on the SSH client side.

4.2.2.3 Typical SSH Server Configuration

Example1:

Requirement: Enable SSH server on the Chassis Switch, and run SSH2.0 client software such as Secure shell client or putty on the terminal. Log on the switch by using the username and password from the client.

Configure the IP address, add SSH user and enable SSH service on the Chassis Switch. SSH2.0 client can log on the switch by using the username and password to configure the Chassis Switch.

```
XGS3-42000R(config)#ssh-server enable
XGS3-42000R(config)#interface vlan 1
XGS3-42000R(config-if-Vlan1)#ip address 100.100.100.200 255.255.255.0
XGS3-42000R(config-if-Vlan1)#exit
XGS3-42000R(config)#ssh-user test password 0 test
```

In IPv6 networks, the terminal should run IPv6-supporting SSH client software, such as putty6. Users should make no modification to configurations on the Chassis Switch except allocating an IPv6 address for the local host.

4.3 Configuration of Chassis Switch IP Addresses

All Ethernet ports of Chassis Switch are default to Data Link layer ports and perform layer 2 forwarding. VLAN interface represent a Layer 3 interface function which can be assigned an IP address, which is also the IP address of the switch. All VLAN interface related configuration commands can be configured under VLAN Mode. Switch provides three IP address configuration methods:

- Manual
- BOOTP
- DHCP

Manual configuration of IP address is assign an IP address manually for the Chassis Switch.

In BOOTP/DHCP mode, the Chassis Switch operates as a BOOTP/DHCP client, send broadcast packets of BOOTP request to the BOOTP/DHCP servers, and the BOOTP/DHCP servers assign the address on receiving the request. In addition, switch can act as a DHCP server, and dynamically assign network parameters such as IP addresses, gateway addresses and DNS server addresses to DHCP clients DHCP Server configuration is detailed in later chapters.

4.3.1 Chassis Switch IP Addresses Configuration Task List

- 1 · Enable VLAN port mode
- 2 · Manual configuration
- 3 · BOOTP configuration
- 4 · DHCP configuration

1. Enable VLAN port mode

Command	Explanation
Global Mode	
interface vlan <vlan-id> no interface vlan <vlan-id>	Create VLAN interface (layer 3 interface); the “ no interface vlan <vlan-id> ” command deletes the VLAN interface.

2. Manual configuration

Command	Explanation
VLAN Port Mode	
ip address <ip_address> <mask> [secondary] no ip address <ip_address> <mask> [secondary]	Configure the VLAN interface IP address; the “ no ip address <ip_address> <mask> [secondary] ” command deletes VLAN interface IP address.
ipv6 address <ipv6-address / prefix-length> [eui-64] no ipv6 address <ipv6-address / prefix-length>	Configure IPv6 address, including aggregation global unicast address, local site address and local link address. The no form command deletes IPv6 address.

3. BOOTP configuration

Command	Explanation
VLAN Port Mode	
ip bootp-client enable no ip bootp-client enable	Enable the switch to be a BootP client and obtain IP address and gateway address through BootP negotiation; the “ no ip bootp-client enable ” command disables the BootP client function.

4. DHCP configuration

Command	Explanation
VLAN Port Mode	
ip bootp-client enable no ip bootp-client enable	Enable the switch to be a DHCP client and obtain IP address and gateway address through DHCP negotiation; the “ no ip bootp-client enable ” command disables the DHCP client function.

4.4 SNMP Configuration

4.4.1 Introduction to SNMP

SNMP (Simple Network Management Protocol) is a standard network management protocol widely used in computer network management. SNMP is an evolving protocol. SNMP v1 [RFC1157] is the first version of SNMP which is adapted by vast numbers of manufacturers for its simplicity and easy implementation; SNMP v2c is an enhanced version of SNMP v1, which supports layered network management; SNMP v3 strengthens the security by adding **USM (User-based Security Mode)** and **VACM (View-based Access Control Model)**.

SNMP protocol provides a simple way of exchange network management information between two points in the network. SNMP employs a polling mechanism of message query, and transmits messages through UDP (a connectionless transport layer protocol). Therefore it is well supported by the existing computer networks.

SNMP protocol employs a station-agent mode. There are two parts in this structure: **NMS (Network Management Station)** and Agent. NMS is the workstation on which SNMP client program is running. It is the core on the SNMP network management. Agent is the server software runs on the devices which need to be managed. NMS manages all the managed objects through Agents. The switch supports Agent function.

The communication between NMS and Agent functions in Client/Server mode by exchanging standard messages. NMS sends request and the Agent responds. There are seven types of SNMP message:

- Get-Request
- Get-Response
- Get-Next-Request
- Get-Bulk-Request
- Set-Request

- Trap
- Inform-Request

NMS sends queries to the Agent with Get-Request, Get-Next-Request, Get-Bulk-Request and Set-Request messages; and the Agent, upon receiving the requests, replies with Get-Response message. On some special situations, like network device ports are on Up/Down status or the network topology changes, Agents can send Trap messages to NMS to inform the abnormal events. Besides, NMS can also be set to alert to some abnormal events by enabling RMON function. When alert events are triggered, Agents will send Trap messages or log the event according to the settings. Inform-Request is mainly used for inter-NMS communication in the layered network management.

USM ensures the transfer security by well-designed encryption and authentication. USM encrypts the messages according to the user typed password. This mechanism ensures that the messages can't be viewed on transmission. And USM authentication ensures that the messages can't be changed on transmission. USM employs **DES-CBC** cryptography. And **HMAC-MD5** and **HMAC-SHA** are used for authentication.

VACM is used to classify the users' access permission. It puts the users with the same access permission in the same group. Users can't conduct the operation which is not authorized.

4.4.2 Introduction to MIB

The network management information accessed by NMS is well defined and organized in a **Management Information Base (MIB)**. MIB is pre-defined information which can be accessed by network management protocols. It is in layered and structured form. The pre-defined management information can be obtained from monitored network devices. ISO ASN.1 defines a tree structure for MID. Each MIB organizes all the available information with this tree structure. And each node on this tree contains an **OID (Object Identifier)** and a brief description about the node. OID is a set of integers divided by periods. It identifies the node and can be used to locate the node in a MID tree structure, shown in the figure below:

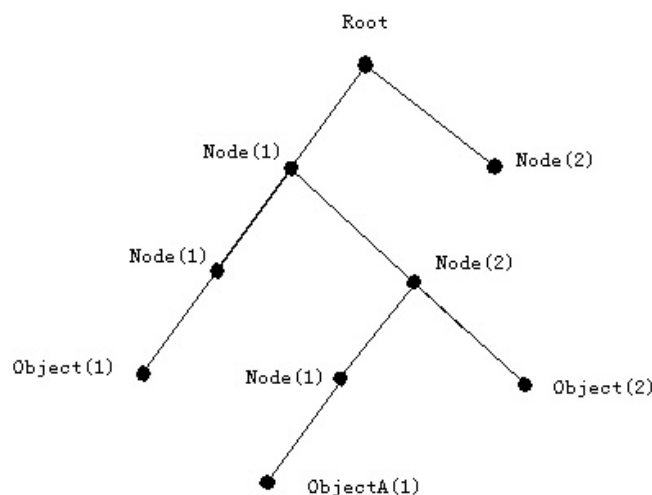

Figure 4-4-1 ASN.1 Tree Instance

In this figure, the OID of the object A is 1.2.1.1. NMS can locate this object through this unique OID and gets the standard variables of the object. MIB defines a set of standard variables for monitored network devices by following this structure.

If the variable information of Agent MIB needs to be browsed, the MIB browse software needs to be run on the NMS. MIB in the Agent usually consists of public MIB and private MIB. The public MIB contains public network management information that can be accessed by all NMS; private MIB contains specific information which can be viewed and controlled by the support of the manufacturers.

MIB-I [RFC1156] is the first implemented public MIB of SNMP, and is replaced by MIB-II [RFC1213]. MIB-II expands MIB-I and keeps the OID of MIB tree in MIB-I. MIB-II contains sub-trees which are called groups. Objects in those groups cover all the functional domains in network management. NMS obtains the network management information by visiting the MIB of SNMP Agent.

The switch can operate as a SNMP Agent, and supports both SNMP v1/v2c and SNMP v3. The switch supports basic MIB-II, RMON public MIB and other public MID such as BRIDGE MIB. Besides, the switch supports self-defined private MIB.

4.4.3 Introduction to RMON

RMON is the most important expansion of the standard SNMP. RMON is a set of MIB definitions, used to define standard network monitor functions and interfaces, enabling the communication between SNMP management terminals and remote monitors. RMON provides a highly efficient method to monitor actions inside the subnets.

MID of RMON consists of 10 groups. The switch supports the most frequently used group 1, 2, 3 and 9:

- **Statistics:** Maintain basic usage and error statistics for each subnet monitored by the Agent.
- **History:** Record periodical statistic samples available from Statistics.
- **Alarm:** Allow management console users to set any count or integer for sample intervals and alert thresholds for RMON Agent records.
- **Event:** A list of all events generated by RMON Agent.

Alarm depends on the implementation of Event. Statistics and History display some current or history subnet statistics. Alarm and Event provide a method to monitor any integer data change in the network, and provide some alerts upon abnormal events (sending Trap or record in logs).

4.4.4 SNMP Configuration

4.4.4.1 SNMP Configuration Task List

1. Enable or disable SNMP Agent server function
2. Configure SNMP community string
3. Configure IP address of SNMP management base
4. Configure engine ID

5. Configure user
6. Configure group
7. Configure view
8. Configuring TRAP
9. Enable/Disable RMON

1. Enable or disable SNMP Agent server function

Command	Explanation
Global Mode	
snmp-server enabled no snmp-server enabled	Enable the SNMP Agent function on the Chassis Switch; the no command disables the SNMP Agent function on the switch.

2. Configure SNMP community string

Command	Explanation
Global Mode	
snmp-server community {ro rw} <string> [access {<num-std> <name>}] [ipv6-access {<ipv6-num-std> <ipv6-name>} [read <read-view-name>] [write <write-view-name>] no snmp-server community <string> [access {<num-std> <name>}] [ipv6-access {<ipv6-num-std> <ipv6-name>}]	Configure the community string for the Chassis Switch; the no command deletes the configured community string.

3. Configure IP address of SNMP management base

Command	Explanation
Global Mode	
snmp-server securityip { <ipv4-addr> / <ipv6-addr> } no snmp-server securityip { <ipv4-addr> / <ipv6-addr> }	Configure the secure IPv4/IPv6 address which is allowed to access the switch on the NMS; the no command deletes configured secure address.
snmp-server securityip enable snmp-server securityip disable	Enable or disable secure IP address check function on the NMS.

4. Configure engine ID

Command	Explanation
Global Mode	
snmp-server engineid <engine-string> no snmp-server engineid	Configure the local engine ID on the Chassis Switch. This command is used for SNMP v3.

5. Configure user

Command	Explanation
Global Mode	
snmp-server user <i><use-string></i> <i><group-string></i> [{authPriv authNoPriv} auth {md5 sha} <i><word></i>] [access {<num-std> <name>}] [ipv6-access {<ipv6-num-std> <ipv6-name>}] no snmp-server user <i><user-string></i> [access {<num-std> <name>}] [ipv6-access {<ipv6-num-std> <ipv6-name>}]	Add a user to a SNMP group. This command is used to configure USM for SNMP v3.

6. Configure group

Command	Explanation
Global Mode	
snmp-server group <i><group-string></i> {noauthnopriv authnopriv authpriv} [[read <i><read-string></i>] [write <i><write-string></i>] [notify <i><notify-string></i>] [access {<num-std> <name>}] [ipv6-access {<ipv6-num-std> <ipv6-name>}] no snmp-server group <i><group-string></i> {noauthnopriv authnopriv authpriv} [access {<num-std> <name>}] [ipv6-access {<ipv6-num-std> <ipv6-name>}]	Set the group information on the Chassis Switch. This command is used to configure VACM for SNMP v3.

7. Configure view

Command	Explanation
Global Mode	
snmp-server view <i><view-string></i> <i><oid-string></i> {include exclude} no snmp-server view <i><view-string></i> [<i><oid-string></i>]	Configure view on the Chassis Switch. This command is used for SNMP v3.

8. Configuring TRAP

Command	Explanation
Global Mode	
snmp-server enable traps no snmp-server enable traps	Enable the switch to send Trap message. This command is used for SNMP v1/v2/v3.
snmp-server host { <i><ipv4-addr></i> <i><ipv6-addr></i> } {v1 v2c {v3 {noauthnopriv / authnopriv authpriv}} } <i><user-string></i> no snmp-server host { <i><ipv4-addr></i> <i><ipv6-addr></i> } {v1 v2c {v3 {noauthnopriv	Set the host IPv4/IPv6 address which is used to receive SNMP Trap information. For SNMP v1/v2, this command also configures Trap community string; for SNMP v3, this command also configures Trap user name and security level. The "no" form of

```
/authnopriv | authpriv}}} <user-string>
```

this command cancels this IPv4 or IPv6 address.

9. Enable/Disable RMON

Command	Explanation
Global mode	
rmon enable no rmon enable	Enable/disable RMON.

4.4.5 Typical SNMP Configuration Examples

The IP address of the NMS is 1.1.1.5; the IP address of the Chassis XGS3-42000R(Agent) is 1.1.1.9.

Scenario 1: The NMS network administrative software uses SNMP protocol to obtain data from the Chassis Switch.

The configuration on the Chassis Switch is listed below:

```
XGS3-42000R(config)#snmp-server enable
XGS3-42000R(config)#snmp-server community rw private
XGS3-42000R(config)#snmp-server community ro public
XGS3-42000R(config)#snmp-server securityip 1.1.1.5
```

The NMS can use private as the community string to access the Chassis Switch with read-write permission, or use public as the community string to access the Chassis Switch with read-only permission.

Scenario 2: NMS will receive Trap messages from the Chassis XGS3-42000R(Note: NMS may have community string verification for the Trap messages. In this scenario, the NMS uses a Trap verification community string of usertrap).

The configuration on the Chassis Switch is listed below:

```
XGS3-42000R(config)#snmp-server enable
XGS3-42000R(config)#snmp-server host 1.1.1.5 v1 usertrap
XGS3-42000R(config)#snmp-server enable traps
```

Scenario 3: NMS uses SNMP v3 to obtain information from the Chassis Switch.

The configuration on the Chassis Switch is listed below:

```
XGS3-42000R(config)#snmp-server
XGS3-42000R(config)#snmp-server user tester UserGroup authPriv auth md5 hellotst
XGS3-42000R(config)#snmp-server group UserGroup AuthPriv read max write max
notify max
XGS3-42000R(config)#snmp-server view max 1 include
```

Scenario 4: NMS wants to receive the v3Trap messages sent by the Chassis Switch.

The configuration on the Chassis Switch is listed below:

```
XGS3-42000R(config)#snmp-server enable
```

```
XGS3-42000R(config)#snmp-server host 10.1.1.2 v3 authpriv tester
XGS3-42000R(config)#snmp-server enable traps
```

Scenario 5: The IPv6 address of the NMS is 2004:1:2:3::2; the IPv6 address of the Chassis XGS3-42000R(Agent) is 2004:1:2:3::1. The NMS network administrative software uses SNMP protocol to obtain data from the Chassis Switch.

The configuration on the Chassis Switch is listed below:

```
XGS3-42000R(config)#snmp-server enable
XGS3-42000R(config)#snmp-server community rw private
XGS3-42000R(config)#snmp-server community ro public
XGS3-42000R(config)#snmp-server securityip 2004:1:2:3::2
```

The NMS can use private as the community string to access the Chassis Switch with read-write permission, or use public as the community string to access the Chassis Switch with read-only permission.

Scenario 6: NMS will receive Trap messages from the Chassis XGS3-42000R(Note: NMS may have community string verification for the Trap messages. In this scenario, the NMS uses a Trap verification community string of dcstrap).

The configuration on the switch is listed below:

```
XGS3-42000R(config)#snmp-server host 2004:1:2:3::2 v1 dcstrap
XGS3-42000R(config)#snmp-server enable traps
```

4.4.6 SNMP Troubleshooting

When users configure the SNMP, the SNMP server may fail to run properly due to physical connection failure and wrong configuration, etc. Users can troubleshoot the problems by following the guide below:

- Good condition of the physical connection.
- Interface and datalink layer protocol is Up (use the “show interface” command), and the connection between the Chassis Switch and host can be verified by ping (use “ping” command).
- The Chassis Switch enabled SNMP Agent server function (use “snmp-server” command)
- Secure IP for NMS (use “snmp-server securityip” command) and community string (use “snmp-server community” command) are correctly configured, as any of them fails, SNMP will not be able to communicate with NMS properly.
- If Trap function is required, remember to enable Trap (use “snmp-server enable traps” command). And remember to properly configure the target host IP address and community string for Trap (use “snmp-server host” command) to ensure Trap message can be sent to the specified host.
- If RMON function is required, RMON must be enabled first (use “rmon enable” command).
- Use “show snmp” command to verify sent and received SNMP messages; Use “show snmp status” command to verify SNMP configuration information; Use “debug snmp packet” to enable SNMP debugging function and verify debug information.

If users still can't solve the SNMP problems, Please contact our technical and service center.

4.5 Switch Upgrade

Chassis Switch provides two ways for switch upgrade: BootROM upgrade and the TFTP/FTP upgrade under Shell.

4.5.1 Chassis Switch System Files

The system files includes system image file and boot file. The updating of the Chassis Switch is to update the two files by overwrite the old files with the new ones.

The system image files refers to the compressed files of the Chassis Switch hardware drivers, and software support program, etc, namely what we usually call the IMG update file. The IMG file can only be saved in the FLASH with a defined name of nos.img

The boot file is for initiating the Chassis Switch, namely what we usually call the ROM update file (It can be compressed into IMG file if it is of large size). The boot file can only be saved in the ROM in which the file name is defined as boot.rom

The update method of the system image file and the boot file is the same. The Chassis Switch supplies the user with two modes of updating: 1. BootROM mode; 2. TFTP and FTP update at Shell mode. This two update method will be explained in details in following two sections.

4.5.2 BootROM Upgrade

There are two methods for BootROM upgrade: TFTP and FTP, which can be selected at BootROM command settings.

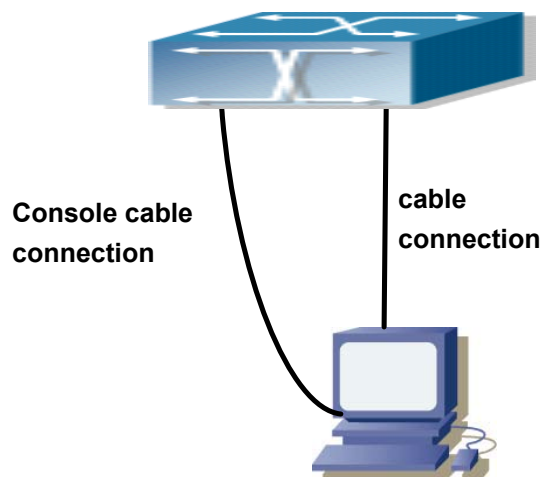

Figure 4-5-1 Typical topology for Chassis Switch upgrade in BootROM mode

The upgrade procedures are listed below:

Step 1:

As shown in the figure, a PC is used as the console for the Chassis Switch. A console cable is used to connect PC to the management port on the Chassis Switch. The PC should have FTP/TFTP server software installed and has the image file required for the upgrade.

Step 2:

Press “ctrl+b” on Chassis Switch boot up until the Chassis Switch enters BootROM monitor mode. The operation result is shown below:

```
[Boot]:
```

Step 3:

Under BootROM mode, run “setconfig” to set the IP address and mask of the Chassis Switch under BootROM mode, server IP address and mask, and select TFTP or FTP upgrade. Suppose the Chassis Switch address is 192.168.1.2, and PC address is 192.168.1.66, and select TFTP upgrade, the configuration should like:

```
[Boot]: setconfig
Host IP Address: [10.1.1.1] 192.168.1.2
Server IP Address: [10.1.1.2] 192.168.1.66
FTP(1) or TFTP(2): [1] 2
Network interface configure OK.
[Boot]
```

Step 4:

Enable FTP/TFTP server in the PC. For TFTP, run TFTP server program; for FTP, run FTP server program. Before start downloading upgrade file to the Chassis Switch, verify the connectivity between the server and the Chassis Switch by ping from the server. If ping succeeds, run “load” command in the BootROM mode from the Chassis Switch; if it fails, perform troubleshooting to find out the cause. The following is the configuration for system update image file.

```
[Boot]: load nos.img
Loading...

Loading file ok!
```

Step 5:

Execute “write nos.img” in BootROM mode. The following saves the system update image file.

```
[Boot]: write nos.img
File nos.img exists, overwrite? (Y/N)?[N] y
Writing nos.img.....
Write nos.img OK.
[Boot]:
```

Step 6:

The following update file boot.rom, the basic environment is the same as Step 4.

```
[Boot]: load boot.rom
Loading...

Loading file ok!
```

Step 7:

Execute "write boot.rom" in BootROM mode. The following saves the update file.

```
[Boot]: write boot.rom

File boot.rom exists, overwrite? (Y/N)?[N] y

Writing boot.rom.....
Write boot.rom OK.
[Boot]:
```

Step 8:

After successful upgrade, execute run or reboot command in BootROM mode to return to CLI configuration interface.

```
[Boot]: run ( or reboot )
```

Other commands in BootROM mode**1. DIR command**

Used to list existing files in the FLASH .

```
[Boot]: dir
boot.rom                327,440 1900-01-01 00:00:00 --SH
boot.conf                83 1900-01-01 00:00:00 --SH
nos.img                  2,431,631 1980-01-01 00:21:34 ----
startup-config           2,922 1980-01-01 00:09:14 ----
temp.img                 2,431,631 1980-01-01 00:00:32 ----
```

2. CONFIG RUN command

Used to set the IMAGE file to run upon system start-up, and the configuration file to run upon configuration recovery.

```
[Boot]: config run
Boot File: [nos.img] nos.img
Config File: [boot.conf]
```

4.5.3 FTP/TFTP Upgrade

4.5.3.1 Introduction to FTP/TFTP

FTP(File Transfer Protocol)/TFTP(Trivial File Transfer Protocol) are both file transfer protocols that belonging to fourth layer(application layer) of the TCP/IP protocol stack, used for transferring files between hosts, hosts and Chassis Switches. Both of them transfer files in a client-server model. Their differences are listed below.

FTP builds upon TCP to provide reliable connection-oriented data stream transfer service. However, it does not provide file access authorization and uses simple authentication mechanism (transfers username and

password in plain text for authentication). When using FTP to transfer files, two connections need to be established between the client and the server: a management connection and a data connection. A transfer request should be sent by the FTP client to establish management connection on port 21 in the server, and negotiate a data connection through the management connection.

There are two types of data connections: active connection and passive connection.

In active connection, the client transmits its address and port number for data transmission to the server, the management connection maintains until data transfer is complete. Then, using the address and port number provided by the client, the server establishes data connection on port 20 (if not engaged) to transfer data; if port 20 is engaged, the server automatically generates some other port number to establish data connection.

In passive connection, the client, through management connection, notify the server to establish a passive connection. The server then creates its own data listening port and informs the client about the port, and the client establishes data connection to the specified port.

As data connection is established through the specified address and port, there is a third party to provide data connection service.

TFTP builds upon UDP, providing unreliable data stream transfer service with no user authentication or permission-based file access authorization. It ensures correct data transmission by sending and acknowledging mechanism and retransmission of time-out packets. The advantage of TFTP over FTP is that it is a simple and low overhead file transfer service.

Chassis Switch can operate as either FTP/TFTP client or server. When Chassis Switch operates as a FTP/TFTP client, configuration files or system files can be downloaded from the remote FTP/TFTP servers (can be hosts or other switches) without affecting its normal operation. And file list can also be retrieved from the server in ftp client mode. Of course, Chassis Switch can also upload current configuration files or system files to the remote FTP/TFTP servers (can be hosts or other switches). When Chassis Switch operates as a FTP/TFTP server, it can provide file upload and download service for authorized FTP/TFTP clients, as file list service as FTP server.

Here are some terms frequently used in FTP/TFTP.

- **ROM:** Short for EPROM, erasable read-only memory. EPROM is replaced by FLASH memory in Chassis Switch.
- **SDRAM:** RAM memory in the Chassis Switch, used for system software operation and configuration sequence storage.
- **FLASH:** Flash memory used to save system file and configuration file.
- **System file:** including system image file and boot file.
- **System image file:** refers to the compressed file for Chassis Switch hardware driver and software support program, usually refer to as IMAGE upgrade file. In Chassis Switch, the system image file is allowed to save in FLASH only. Chassis Switch mandates the name of system image file to be uploaded via FTP in Global Mode to be nos.img, other IMAGE system files will be rejected.
- **Boot file:** refers to the file initializes the Chassis Switch, also referred to as the ROM upgrade file (Large size file can be compressed as IMAGE file). In Chassis Switch, the boot file is allowed to save in ROM only. Chassis Switch mandates the name of the boot file to be boot.rom.
- **Configuration file:** including start up configuration file and running configuration file. The

distinction between start up configuration file and running configuration file can facilitate the backup and update of the configurations.

- **Start up configuration file:** refers to the configuration sequence used in Chassis Switch start up. Chassis Switch start up configuration file stores in FLASH only, corresponding to the so called configuration save. To prevent illicit file upload and easier configuration, Chassis Switch mandates the name of start up configuration file to be startup-config.
- **Running configuration file:** refers to the running configuration sequence use in the Chassis Switch. In Chassis Switch, the running configuration file stores in the RAM. In the current version, the running configuration sequence running-config can be saved from the RAM to FLASH by **write** command or **copy running-config startup-config** command, so that the running configuration sequence becomes the start up configuration file, which is called configuration save. To prevent illicit file upload and easier configuration, Chassis Switch mandates the name of running configuration file to be running-config.
- **Factory configuration file:** The configuration file shipped with Chassis Switch in the name of factory-config. Run set default and write, and restart the Chassis Switch, factory configuration file will be loaded to overwrite current start up configuration file.

4.5.3.2 FTP/TFTP Configuration

The configurations of Chassis Switch as FTP and TFTP clients are almost the same, so the configuration procedures for FTP and TFTP are described together in this manual.

4.5.3.2.1 FTP/TFTP Configuration Task List

1. FTP/TFTP client configuration

- (1) Upload/download the configuration file or system file.
- (2) For FTP client, server file list can be checked.

2. FTP server configuration

- (1) Start FTP server
- (2) Configure FTP login username and password
- (3) Modify FTP server connection idle time
- (4) Shut down FTP server

3. TFTP server configuration

- (1) Start TFTP server
- (2) Configure TFTP server connection idle time
- (3) Configure retransmission times before timeout for packets without acknowledgement
- (4) Shut down TFTP server

1. FTP/TFTP client configuration

(1) FTP/TFTP client upload/download file

Command	Explanation
Admin Mode	
copy <source-url> <destination-url> [ascii binary]	FTP/TFTP client upload/download file.

(2) For FTP client, server file list can be checked.

Admin Mode	
ftp-dir <ftpServerUrl>	For FTP client, server file list can be checked. FtpServerUrl format looks like: ftp://user: password@IPv4 IPv6 Address.

2. FTP server configuration

(1) Start FTP server

Command	Explanation
Global Mode	
ftp-server enable no ftp-server enable	Start FTP server and support IPv4, IPv6, the no command shuts down FTP server and prevents FTP user from logging in.

(2) Configure FTP login username and password

Command	Explanation
Global Mode	
ip ftp username <username> {no password password {0 7} <password>} no ip ftp username<username>	Configure FTP login username and password; this no command will delete the username and password.

(3) Modify FTP server connection idle time

Command	Explanation
Global Mode	
ftp-server timeout <seconds>	Set connection idle time.

3. TFTP server configuration

(1) Start TFTP server

Command	Explanation
Global Mode	
tftp-server enable no tftp-server enable	Start TFTP server, the no command shuts down TFTP server and prevents TFTP user from logging in.

(2) Modify TFTP server connection idle time

Command	Explanation
Global Mode	
ftp-server retransmission-timeout <seconds>	Set maximum retransmission time within timeout interval.

(3) Modify TFTP server connection retransmission time

Command	Explanation
Global Mode	
ftp-server retransmission-number <number>	Set the retransmission time for TFTP server.

4.5.3.3 FTP/TFTP Configuration Examples

It is the same configuration Chassis Switch for IPv4 addresses and IPv6 addresses. The example only for the IPv4 addresses configuration.

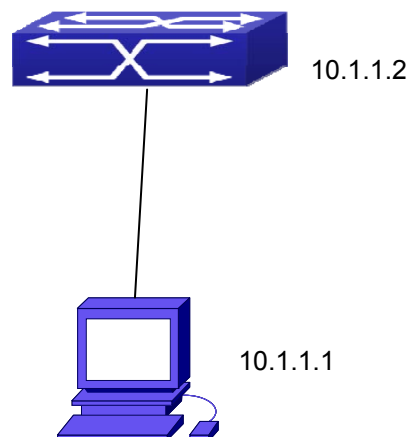

Figure 4-5-2 Download nos.img file as FTP/TFTP client

Scenario 1: The Chassis Switch is used as FTP/TFTP client. The Chassis Switch connects from one of its ports to a computer, which is a FTP/TFTP server with an IP address of 10.1.1.1; the Chassis Switch acts as a FTP/TFTP client, the IP address of the Chassis Switch management VLAN is 10.1.1.2. Download “nos.img” file in the computer to the Chassis Switch.

■ FTP Configuration

Computer side configuration:

Start the FTP server software on the computer and set the username “Switch”, and the password “switch”. Place the “12_30_nos.img” file to the appropriate FTP server directory on the computer.

The configuration procedures of the switch are listed below:

```
XGS3-42000R(config)#interface vlan 1
```

```
XGS3-42000R(config-if-Vlan1)#ip address 10.1.1.2 255.255.255.0
XGS3-42000R(config-if-Vlan1)#no shut
XGS3-42000R(config-if-Vlan1)#exit
XGS3-42000R(config)#exit
XGS3-42000R#copy ftp: //Switch:switch@10.1.1.1/12_30_nos.img nos.img
```

With the above commands, the Chassis Switch will have the “nos.img” file in the computer downloaded to the FLASH.

■ TFTP Configuration

Computer side configuration:

Start TFTP server software on the computer and place the “nos.img” file to the appropriate TFTP server directory on the computer.

The configuration procedures of the Chassis Switch are listed below:

```
XGS3-42000R(config)#interface vlan 1
XGS3-42000R(config-if-Vlan1)#ip address 10.1.1.2 255.255.255.0
XGS3-42000R(config-if-Vlan1)#no shut
XGS3-42000R(config-if-Vlan1)#exit
XGS3-42000R(config)#exit
XGS3-42000R#copy tftp: //10.1.1.1/12_30_nos.img nos.img
```

Scenario 2: The Chassis Switch is used as FTP server. The Chassis Switch operates as the FTP server and connects from one of its ports to a computer, which is a FTP client. Transfer the “nos.img” file in the Chassis Switch to the computer and save as 12_25_nos.img.

The configuration procedures of the Chassis Switch are listed below:

```
XGS3-42000R(config)#interface vlan 1
XGS3-42000R(config-if-Vlan1)#ip address 10.1.1.2 255.255.255.0
XGS3-42000R(config-if-Vlan1)#no shut
XGS3-42000R(config-if-Vlan1)#exit
XGS3-42000R(config)#ftp-server enable
XGS3-42000R(config)# username Admin password 0 switch
```

Computer side configuration:

Login to the Chassis Switch with any FTP client software, with the username “Admin” and password “switch”, use the command “get nos.img 12_25_nos.img” to download “nos.img” file from the Chassis Switch to the computer.

Scenario 3: The Chassis Switch is used as TFTP server. The Chassis Switch operates as the TFTP server and connects from one of its ports to a computer, which is a TFTP client. Transfer the “nos.img” file in the Chassis Switch to the computer.

The configuration procedures of the Chassis Switch are listed below:

```
XGS3-42000R(config)#interface vlan 1
```

```
XGS3-42000R(config-if-Vlan1)#ip address 10.1.1.2 255.255.255.0
XGS3-42000R(config-if-Vlan1)#no shut
XGS3-42000R(config-if-Vlan1)#exit
XGS3-42000R(config)#ftp-server enable
Computer side configuration:
```

Login to the Chassis Switch with any TFTP client software, use the “tftp” command to download “nos.img” file from the Chassis Switch to the computer.

Scenario 4: Chassis Switch acts as FTP client to view file list on the FTP server.

Synchronization conditions: The Chassis Switch connects to a computer by an Ethernet port, the computer is a FTP server with an IP address of 10.1.1.1; the Chassis Switch acts as a FTP client, and the IP address of the Chassis Switch management VLAN1 interface is 10.1.1.2.

■ FTP Configuration

PC side:

Start the FTP server software on the PC and set the username “Switch”, and the password “Admin”.

Switch:

```
XGS3-42000R(config)#interface vlan 1
XGS3-42000R(config-if-Vlan1)#ip address 10.1.1.2 255.255.255.0
XGS3-42000R(config-if-Vlan1)#no shut
XGS3-42000R(config-if-Vlan1)#exit
XGS3-42000R#copy ftp: //Switch: superuser@10.1.1.1
220 Serv-U FTP-Server v2.5 build 6 for WinSock ready...
331 User name okay, need password.
230 User logged in, proceed.
200 PORT Command successful.
150 Opening ASCII mode data connection for /bin/ls.
recv total = 480
nos.img
nos.rom
parsecommandline.cpp
position.doc
qmdict.zip
...(some display omitted here)
show.txt
snmp.TXT
226 Transfer complete.
```

4.5.3.4 FTP/TFTP Troubleshooting

4.5.3.4.1 FTP Troubleshooting

When upload/download system file with FTP protocol, the connectivity of the link must be ensured, i.e., use the “Ping” command to verify the connectivity between the FTP client and server before running the FTP program. If ping fails, you will need to check for appropriate troubleshooting information to recover the link connectivity.

- The following is what the message displays when files are successfully transferred. Otherwise, please verify link connectivity and retry “copy” command again.

```
220 Serv-U FTP-Server v2.5 build 6 for WinSock ready...
331 User name okay, need password.
230 User logged in, proceed.
200 PORT Command successful.
nos.img file length = 1526021
read file ok
send file
150 Opening ASCII mode data connection for nos.img.
226 Transfer complete.
close ftp client.
```

- The following is the message displays when files are successfully received. Otherwise, please verify link connectivity and retry “copy” command again.

```
220 Serv-U FTP-Server v2.5 build 6 for WinSock ready...
331 User name okay, need password.
230 User logged in, proceed.
200 PORT Command successful.
recv total = 1526037
*****
write ok
150 Opening ASCII mode data connection for nos.img (1526037 bytes).
226 Transfer complete.
```

- If the Chassis Switch is upgrading system file or system start up file through FTP, the Chassis Switch must not be restarted until “close ftp client” or “226 Transfer complete.” is displayed, indicating upgrade is successful, otherwise the Chassis Switch may be rendered unable to start. If the system file and system start up file upgrade through FTP fails, please try to upgrade again or use the BootROM mode to upgrade.

4.5.3.4.2 TFTP Troubleshooting

When upload/download system file with TFTP protocol, the connectivity of the link must be ensured, i.e., use the “**Ping**” command to verify the connectivity between the TFTP client and server before running the TFTP program. If ping fails, you will need to check for appropriate troubleshooting information to recover the link connectivity.

- The following is the message displays when files are successfully transferred. Otherwise, please verify link connectivity and retry “copy” command again.

```
nos.img file length = 1526021
read file ok
begin to send file, wait...
file transfers complete.
Close tftp client.
```

- The following is the message displays when files are successfully received. Otherwise, please verify link connectivity and retry “copy” command again.

```
begin to receive file, wait...
recv 1526037
*****

write ok
transfer complete
close tftp client.
```

If the Chassis Switch is upgrading system file or system start up file through TFTP, the Chassis Switch must not be restarted until “close tftp client” is displayed, indicating upgrade is successful, otherwise the Chassis Switch may be rendered unable to start. If the system file and system start up file upgrade through TFTP fails, please try upgrade again or use the BootROM mode to upgrade.

Chapter 5 File System Operations

5.1 Introduction to File Storage Devices

File storage devices used in switches mainly include FLASH cards. As the most common storage device, FLASH is usually used to store system image files (IMG files), system boot files (ROM files) and system configuration files (CFG files).

Flash can copy, delete, or rename files under Shell or Bootrom mode.

5.2 File System Operation Configuration Task list

1. Mounting and unmounting operations of memory cards
2. The formatting operation of storage devices
3. The creation of sub-directories
4. The deletion of sub-directory
5. Changing the current working directory of the storage device
6. The display operation of the current working directory
7. The display operation of information about a designated file or directory
8. The deletion of a designated file in the file system
9. The renaming operation of files
10. The copying operation of files

1. Mounting and unmounting operations of memory cards

Command	Explanation
Admin Configuration Mode	
mount <device> unmount <device>	Mount and unmount memory cards.

2. The formatting operation of storage devices

Command	Explanation
Admin Configuration Mode	
format <device>	Format the storage device.

3. The creation of sub-directories

Command	Explanation
Admin Configuration Mode	
mkdir <directory>	Create a sub-directory in a designated directory on a certain device.

4. The deletion of sub-directory

Command	Explanation
Admin Configuration Mode	
rmdir <directory>	Delete a sub-directory in a designated directory on a certain device.

5. Changing the current working directory of the storage device

Command	Explanation
Admin Configuration Mode	
cd <directory>	Change the current working directory of the storage device.

6. The display operation of the current working directory

Command	Explanation
Admin Configuration Mode	
pwd	Display the current working directory.

7. The display operation of information about a designated file or directory

Command	Explanation
Admin Configuration Mode	
dir [WORD]	Display information about a designated file or directory on the storage device.

8. The deletion of a designated file in the file system

Command	Explanation
Admin Configuration Mode	
delete <file-url>	Delete the designated file in the file system.

9. The renaming operation of files

Command	Explanation
Admin Configuration Mode	
rename <source-file-url> <dest-file>	Change the name of a designated file on the Chassis Switch to a new one.

10. The copy operation of files

Command	Explanation
Admin Configuration Mode	
copy <source-file-url> <dest-file-url>	Copy a designated file one the Chassis Switch and store it as a new one.

5.3 Typical Applications

Copy an IMG file flash:/nos.img stored in the FLASH on the boardcard, to cf:/nos-5.2.1.0.img.

The configuration of the Chassis Switch is as follows:

```
XGS3-42000R#copy flash:/nos.img flash:/nos-5.2.1.0.img
Copy flash:/nos.img to flash:/nos-5.2.1.0.img? [Y:N] y
Copied file flash:/nos.img to flash:/nos-5.2.1.0.img.
```

5.4 Troubleshooting

If errors occur when users try to implement file system operations, please check whether they are caused by the following reasons

- Whether file names or paths are entered correctly.
- When renaming a file, whether it is in use or the new file name is already used by an existing file or directory.

Chapter 6 Cluster Configuration

6.1 Introduction to cluster network management

Cluster network management is an in-band configuration management. Unlike CLI, SNMP and Web Config which implement a direct management of the target switches through a management workstation, cluster network management implements a direct management of the target switches (member switches) through an intermediate XGS3-42000R(commander switch). A commander switch can manage multiple member switches. As soon as a Public IP address is configured in the commander switch, all the member switches which are configured with private IP addresses can be managed remotely. This feature economizes public IP addresses which are short of supply. Cluster network management can dynamically discover cluster feature enabled switches (candidate switches). Network administrators can statically or dynamically add the candidate switches to the cluster which is already established. Accordingly, they can configure and manage the member switches through the commander switch. When the member switches are distributed in various physical locations (such as on the different floors of the same building), cluster network management has obvious advantages. Moreover, cluster network management is an in-band management. The commander switch can communicate with member switches in existing network. There is no need to build a specific network for network management.

Cluster network management has the following features:

- Save IP addresses
- Simplify configuration tasks
- Indifference to network topology and distance limitation
- Auto detecting and auto establishing
- With factory default settings, multiple switches can be managed through cluster network management
- The commander switch can upgrade and configure any member switches in the cluster

6.2 Cluster Network Management Configuration Sequence

Cluster Network Management Configuration Sequence:

- 1 · Enable or disable cluster function
- 2 · Create cluster
 - 1) Configure private IP address pool for member switches of the cluster
 - 2) Create or delete cluster
 - 3) Add or remove a member switch
- 3 · Configure attributes of the cluster in the commander switch
 - 1) Enable or disable automatically adding cluster members
 - 2) Set automatically added members to manually added ones
 - 3) Set or modify the time interval of keep-alive messages on switches in the cluster.
 - 4) Set or modify the max number of lost keep-alive messages that can be tolerated
 - 5) Clear the list of candidate switches maintained by the switch

- 4 · Configure attributes of the cluster in the candidate switch
 - 1) Set the time interval of keep-alive messages of the cluster
 - 2) Set the max number of lost keep-alive messages that can be tolerated in the cluster
- 5 · Remote cluster network management
 - 1) Remote configuration management
 - 2) Remotely upgrade member switch
 - 3) Reboot member switch
- 6 · Manage cluster network with web
 - 1) Enable http
- 7 · Manage cluster network with snmp
 - 1) Enable snmp server

1. Enable or disable cluster

Command	Explanation
Global Mode	
cluster run [key <WORD>] [vid <VID>] no cluster run	Enable or disable cluster function in the Chassis Switch.

2. Create a cluster

Command	Explanation
Global Mode	
cluster ip-pool <commander-ip> no cluster ip-pool	Configure the private IP address pool for cluster member devices.
cluster commander [<cluster_name>] no cluster commander	Create or delete a cluster.
cluster member {candidate-sn <candidate-sn> mac-address <mac-addr> [id <member-id>]} no cluster member {id <member-id> mac-address <mac-addr>}	Add or remove a member switch.

3. Configure attributes of the cluster in the commander switch

Command	Explanation
Global Mode	
cluster auto-add no cluster auto-add	Enable or disable adding newly discovered candidate switch to the cluster.
cluster member auto-to-user	Change automatically added members into manually added ones.
cluster keepalive interval <second> no cluster keepalive interval	Set the keep-alive interval of the cluster.
cluster keepalive loss-count <int> no cluster keepalive loss-count	Set the max number of lost keep-alive messages that can be tolerated in the cluster.
Admin mode	

clear cluster nodes [nodes-sn <candidate-sn-list> mac-address <mac-addr>]	Clear nodes in the list of candidate switches maintained by the switch.
--	---

4. Configure attributes of the cluster in the candidate switch

Command	Explanation
Global Mode	
cluster keepalive interval <second> no cluster keepalive interval	Set the keep-alive interval of the cluster.
cluster keepalive loss-count <int> no cluster keepalive loss-count	Set the max number of lost keep-alive messages that can be tolerated in the clusters.

5. Remote cluster network management

Command	Explanation
Admin Mode	
rcommand member <member-id>	In the commander switch, this command is used to configure and manage member switches.
rcommand commander	In the member switch, this command is used to configure the commander switch.
cluster reset member [id <member-id> mac-address <mac-addr>]	In the commander switch, this command is used to reset the member switch.
cluster update member <member-id> <src-url> <dst-filename> [ascii binary]	In the commander switch, this command is used to remotely upgrade the member switch. It can only upgrade nos.img file.

6. Manage cluster network with web

Command	Explanation
Global Mode	
ip http server	Enable http function in commander switch and member switch. Notice: must insure the http function be enabled in member switch when commander switch visiting member switch by web. The commander switch visit member switch via beat member node in member cluster topology.

7. Manage cluster network with snmp

Command	Explanation
Global Mode	
<code>snmp-server enable</code>	<p>Enable snmp server function in commander switch and member switch.</p> <p>Notice: must insure the snmp server function be enabled in member switch when commander switch visiting member switch by snmp. The commander switch visit member switch via configure character string <commander-community>@sw<member id>.</p>

6.3 Examples of Cluster Administration

Scenario:

The four switches SW1-SW4, amongst the SW1 is the command switch and other switches are member switch. The SW2 and SW4 is directly connected with the command switch, SW3 connects to the command switch through SW2.

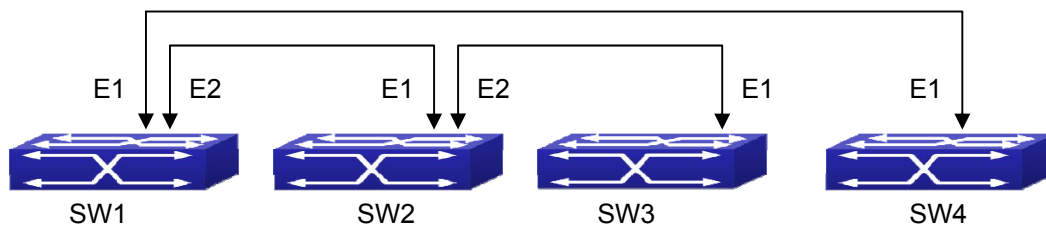

Figure 6-3-1 Examples of Cluster

Configuration Procedure

1. Configure the command switch

Configuration of SW1:

```
XGS3-42000R(config)#cluster run
XGS3-42000R(config)#cluster ip-pool 10.2.3.4
XGS3-42000R(config)#cluster commander 5526
XGS3-42000R(config)#cluster auto-add
```

2. Configure the member switch

Configuration of SW2-SW4

```
XGS3-42000R(config)#cluster run
```

6.4 Cluster Administration Troubleshooting

When encountering problems in applying the cluster admin, please check the following possible causes:

- If the command switch is correctly configured and the auto adding function (cluster auto-add) is enabled. If the ports connected the command switch and member switch belongs to the cluster vlan.
- After cluster commander is enabled in VLAN1 of the command switch, please don't enable a routing protocol (RIP, OSPF, BGP) in this VLAN in order to prevent the routing protocol from broadcasting the private cluster addresses in this VLAN to other switches and cause routing loops.
- Whether the connection between the command switch and the member switch is correct. We can use the debug cluster packets to check if the command and the member switches can receive and process related cluster admin packets correctly.

Chapter 7 Port Configuration

7.1 Introduction to Port

XGS3-42000R Chassis Switches contain Cable ports and Combo ports. The Combo ports can be configured to as either 1000GX-TX ports or SFP Gigabit fiber ports.

If the user needs to configure some network ports, he/she can use the interface ethernet <interface-list> command to enter the appropriate Ethernet port configuration mode, where <interface-list> stands for one or more ports. If <interface-list> contains multiple ports, special characters such as ';' or '-' can be used to separate ports, ';' is used for discrete port numbers and '-' is used for consecutive port numbers. Suppose an operation should be performed on ports 2, 3, 4, 5, the command would look like: interface ethernet 1/2-5. Port speed, duplex mode and traffic control can be configured under Ethernet Port Mode causing the performance of the corresponding network ports to change accordingly.

7.2 Network Port Configuration Task List

1. Enter the network port configuration mode
2. Configure the properties for the network ports
 - (1) Configure combo mode for combo ports
 - (2) Enable/Disable ports
 - (3) Configure port names
 - (4) Configure port cable types
 - (5) Configure port speed and duplex mode
 - (6) Configure bandwidth control
 - (7) Configure traffic control
 - (8) Enable/Disable port loopback function
 - (9) Configure broadcast storm control function for the Chassis Switch

1. Enter the Ethernet port configuration mode

Command	Explanation
Global Mode	
interface ethernet <interface-list>	Enters the network port configuration mode.

2. Configure the properties for the Ethernet ports

Command	Explanation
Port Mode	
combo-forced-mode {copper-forced copper-preferred-auto sfp-forced sfp-preferred-auto }	Sets the combo port mode (combo ports only).

shutdown no shutdown	Enables/Disables specified ports.
name <string> no name	Names or cancels the name of specified ports.
mdi {auto across normal} no mdi	Sets the cable type for the specified port; this command is not supported by combo port and fiber port of Chassis Switch.
speed-duplex {auto force10-half force10-full force100-half force100-full force100-fx [module-type {auto-detected no-phy-integrated phy-integrated}] [force1g-half force1g-full] [nonegotiate [master slave]] } } no speed-duplex	Sets port speed and duplex mode of 100/1000BASE-TX or 100BASE-FX ports. The no format of this command restores the default setting, i.e., negotiates speed and duplex mode automatically.
negotiation {on off}	Enables/Disables the auto-negotiation function of 1000BASE-FX ports.
bandwidth control <bandwidth> [both receive transmit] no bandwidth control	Sets or cancels the bandwidth used for incoming/outgoing traffic for specified ports.
flow control no flow control	Enables/Disables traffic control function for specified ports.
loopback no loopback	Enables/Disables loopback test function for specified ports.
rate-suppression {dlf broadcast multicast} <packets>	Enables the storm control function for broadcasts, multicasts and unicasts with unknown destinations (short for broadcast), and sets the allowed broadcast packet number; the no format of this command disables the broadcast storm control function.

7.3 Port Configuration Example

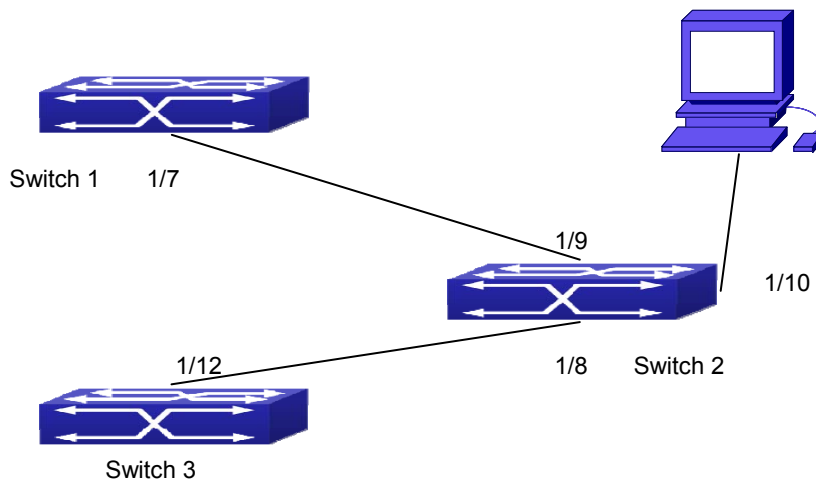

Figure 7-3-1 Port Configuration Example

No VLAN has been configured in the switches, default VLAN1 is used.

Switch	Port	Property
Switch1	1/7	Ingress bandwidth limit: 150 M
Switch2	1/8	Mirror source port
	1/9	100Mbps full, mirror source port
	1/10	1000Mbps full, mirror destination port
Switch3	1/12	100Mbps full

The configurations are listed below:

Switch1:

```
Switch1(config)#interface ethernet 1/7
Switch1(Config-If-Ethernet1/7)#bandwidth control 50 both
```

Switch2:

```
Switch2(config)#interface ethernet 1/9
Switch2(Config-If-Ethernet1/9)#speed-duplex force100-full
Switch2(Config-If-Ethernet1/9)#exit
Switch2(config)#interface ethernet 1/10
Switch2(Config-If-Ethernet1/10)# speed-duplex force1000-full
Switch2(Config-If-Ethernet1/10)#exit
Switch2(config)#monitor session 1 source interface ethernet1/8;1/9
Switch2(config)#monitor session 1 destination interface ethernet 1/10
```

Switch3:

```
Switch3(config)#interface ethernet 1/12
Switch3(Config-If-Ethernet1/12)#speed-duplex force1000-full
Switch3(Config-If-Ethernet1/12)#exit
```

7.4 Port Troubleshooting

Here are some situations that frequently occurs in port configuration and the advised solutions:

- Two connected fiber interfaces won't link up if one interface is set to auto-negotiation but the other to forced speed/duplex. This is determined by IEEE 802.3.
- The following combinations are not recommended: enabling traffic control as well as setting multicast limiting for the same port; setting broadcast, multicast and unknown destination unicast control as well as port bandwidth limiting for the same port. If such combinations are set, the port throughput may fall below the expected performance.

Chapter 8 Port Isolation Function Configuration

8.1 Introduction to Port Isolation Function

Port isolation is an independent port-based function working in an inter-port way, which isolates flows of different ports from each other. With the help of port isolation, users can isolate ports within a VLAN to save VLAN resources and enhance network security. After this function is configured, the ports in a port isolation group will be isolated from each other, while ports belonging to different isolation groups or no such group can forward data to one another normally. No more than 16 port isolation groups can a Chassis Switch have.

8.2 Task Sequence of Port Isolation

1. Create an isolate port group
2. Add Ethernet ports into the group
3. Specify the flow to be isolated
4. Display the configuration of port isolation

1. Create an isolate port group

Command	Explanation
Global Mode	
isolate-port group <WORD> no isolate-port group <WORD>	Set a port isolation group; the no operation of this command will delete the port isolation group.

2. Add Ethernet ports into the group

Command	Explanation
Global Mode	
isolate-port group <WORD> switchport interface [<ethernet>] <IFNAME> no isolate-port group <WORD> switchport interface [<ethernet>] <IFNAME>	Add one port or a group of ports into a port isolation group to isolate, which will become isolated from the other ports in the group; the no operation of this command will remove one port or a group of ports out of a port isolation group.

3. Specify the flow to be isolated

Command	Explanation
Global Mode	
isolate-port apply [<I2 I3 all>]	Apply the port isolation configuration to isolate layer-2 flows, layer-3 flows or all flows.

4. Display the configuration of port isolation

Command	Explanation
Admin Mode and global Mode	
show isolate-port group [<WORD>]	Display the configuration of port isolation, including all configured port isolation groups and Ethernet ports in each group.

8.3 Port Isolation Function Typical Examples

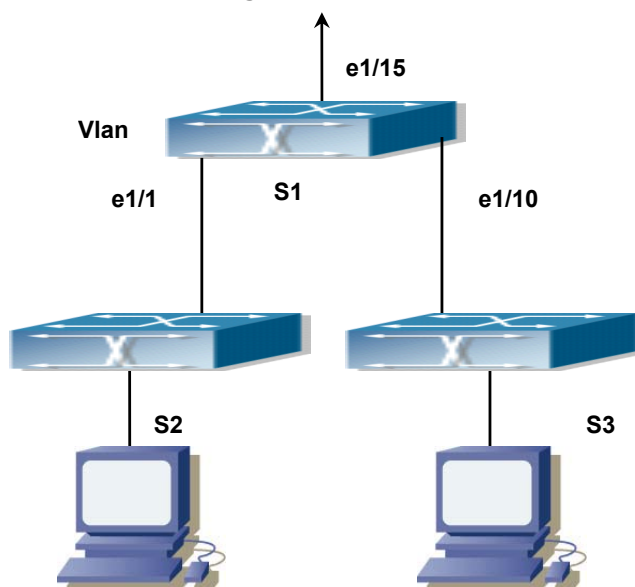

Figure 8-3-1 A typical example of port isolation function

The topology and configuration of switches are showed in the figure above, with e1/1, e1/10 and e1/15 all belonging to VLAN 100. The requirement is that, after port isolation is enabled on switch S1, e1/1 and e1/10 on switch S1 can not communicate with each other, while both of them can communicate with the uplink port e1/15. That is, the communication between any pair of downlink ports is disabled while that between any downlink port and a specified uplink port is normal. The uplink port can communicate with any port normally.

The configuration of S1:

```
XGS3-42000R(config)#isolate-port group test
XGS3-42000R(config)#isolate-port group test switchport interface ethernet 1/1;1/10
```

Chapter 9 Port Loopback Detection Function Configuration

9.1 Introduction to Port Loopback Detection Function

With the development of Chassis Switches, more and more users begin to access the network through Ethernet switches. In enterprise network, users access the network through layer-2 switches, which means urgent demands for both internet and the internal layer 2 Interworking. When layer 2 Interworking is required, the messages will be forwarded through MAC addressing the accuracy of which is the key to a correct Interworking between users. In layer 2 switching, the messages are forwarded through MAC addressing. Layer 2 devices learn MAC addresses via learning source MAC address, that is, when the port receives a message from an unknown source MAC address, it will add this MAC to the receive port, so that the following messages with a destination of this MAC can be forwarded directly, which also means learn the MAC address once and for all to forward messages.

When a new source MAC is already learnt by the layer 2 device, only with a different source port, the original source port will be modified to the new one, which means to correspond the original MAC address with the new port. As a result, if there is any loopback existing in the link, all MAC addresses within the whole layer 2 network will be corresponded with the port where the loopback appears (usually the MAC address will be frequently shifted from one port to another), causing the layer 2 network collapsed. That is why it is a necessity to check port loopbacks in the network. When a loopback is detected, the detecting device should send alarms to the network management system, ensuring the network manager is able to discover, locate and solve the problem in the network and protect users from a long-lasting disconnected network.

Since detecting loopbacks can make dynamic judgment of the existence of loopbacks in the link and tell whether it has gone, the devices supporting port control (such as port isolation and port MAC address learning control) can maintain that automatically, which will not only reduce the burden of network managers but also response time, minimizing the effect caused loopbacks to the network.

9.2 Port Loopback Detection Function Configuration Task List

- 1 · Configure the time interval of loopback detection
- 2 · Enable the function of port loopback detection
- 3 · Configure the control method of port loopback detection
- 4 · Display and debug the relevant information of port loopback detection
- 5 · Configure the loopback-detection control mode (automatic recovery enabled or not)

1 · Configure the time interval of loopback detection

Command	Explanation
Global Mode	
loopback-detection interval-time <loopback> <no-loopback> no loopback-detection interval-time	Configure the time interval of loopback detection.

2 · Enable the function of port loopback detection

Command	Explanation
Port Mode	
loopback-detection specified-vlan <vlan-list> no loopback-detection specified-vlan <vlan-list>	Enable and disable the function of port loopback detection.

3 · Configure the control method of port loopback detection

Command	Explanation
Port Mode	
loopback-detection control {shutdown block learning} no loopback-detection control	Enable and disable the function of port loopback detection control.

4 · Display and debug the relevant information of port loopback detection

Command	Explanation
Admin Mode	
debug loopback-detection no debug loopback-detection	Enable the debug information of the function module of port loopback detection. The no operation of this command will disable the debug information.
show loopback-detection [interface <interface-list>]	Display the state and result of the loopback detection of all ports, if no parameter is provided; otherwise, display the state and result of the corresponding ports.

5. Configure the loopback-detection control mode (automatic recovery enabled or not)

Command	Explanation
Global Mode	
loopback-detection control-recovery timeout <0-3600>	Configure the loopback-detection control mode (automatic recovery enabled or not) or recovery time.

9.3 Port Loopback Detection Function Example



Figure 9-3-1 A typical example of port loopback detection

As shown in the above configuration, the Chassis Switch will detect the existence of loopbacks in the network topology. After enabling the function of loopback detection on the port connecting the Chassis Switch with the outside network, the Chassis Switch will notify the connected network about the existence of a loopback, and control the port on the switch to guarantee the normal operation of the whole network.

The configuration task sequence of SWITCH:

```
XGS3-42000R(config)#loopback-detection interval-time 35 15
XGS3-42000R(config)#interface ethernet 1/1
XGS3-42000R(config-If-Ethernet1/1)#loopback-detection special-vlan 1-3
XGS3-42000R(config-If-Ethernet1/1)#loopback-detection control block
```

If adopting the control method of block, MSTP should be globally enabled. And the correspondence between the spanning tree instance and the VLAN should be configured.

```
XGS3-42000R(config)#spanning-tree
XGS3-42000R(config)#spanning-tree mst configuration
XGS3-42000R(config-Mstp-Region)#instance 1 vlan 1
XGS3-42000R(config-Mstp-Region)#instance 2 vlan 2
XGS3-42000R(config-Mstp-Region)#
```

9.4 Port Loopback Detection Troubleshooting

The function of port loopback detection is disabled by default and should only be enabled if required.

Chapter 10 ULDP Function Configuration

10.1 Introduction to ULDP Function

Unidirectional link is a common error state of link in networks, especially in fiber links. Unidirectional link means that only one port of the link can receive messages from the other port, while the latter one can not receive messages from the former one. Since the physical layer of the link is connected and works normal, via the checking mechanism of the physical layer, communication problems between the devices can not be found. As shown in Graph, the problem in fiber connection can not be found through mechanisms in physical layer like automatic negotiation.

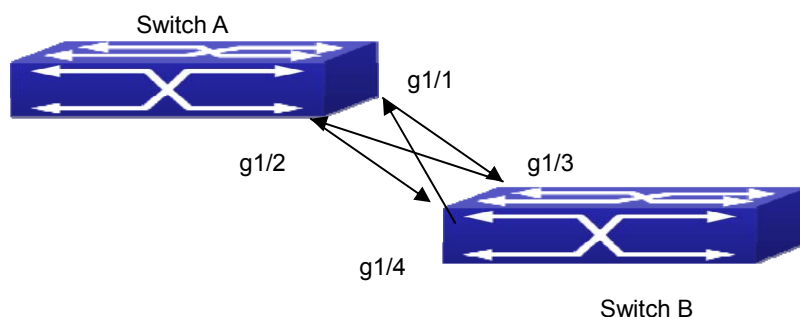

Figure 10-1-1 Fiber Cross Connection

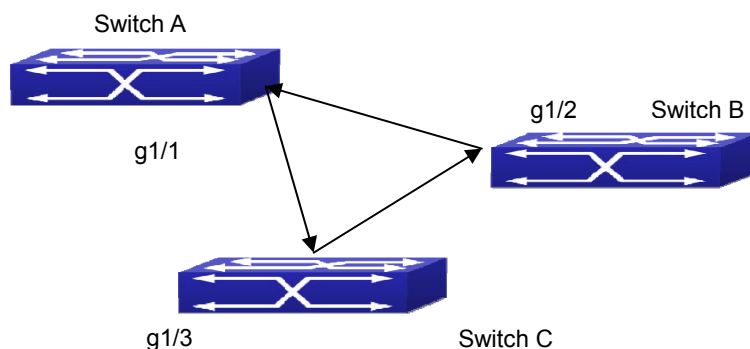

Figure 10-1-2 One End of Each Fiber Not Connected

This kind of problem often appears in the following situations: GBIC (Giga Bitrate Interface Converter) or interfaces have problems, software problems, hardware becomes unavailable or operates abnormally. Unidirectional link will cause a series of problems, such as spinning tree topological loop, broadcast black hole.

ULDP (Unidirectional Link Detection Protocol) can help avoid disasters that could happen in the situations mentioned above. In a Chassis Switch connected via fibers or copper Ethernet line (like ultra five-kind twisted pair), ULDP can monitor the link state of physical links. Whenever a unidirectional link is discovered, it will send warnings to users and can disable the port automatically or manually according to users' configuration.

The ULDP of switches recognizes remote devices and check the correctness of link connections via interacting ULDP messages. When ULDP is enabled on a port, protocol state machine will be started, which means different types of messages will be sent at different states of the state machine to check the connection state of the link by exchanging information with remote devices. ULDP can dynamically study the interval at which the remote device sends notification messages and adjust the local TTL (time to live) according to that interval. Besides, ULDP provides the reset mechanism, when the port is disabled by ULDP, it can check again through reset mechanism. The time intervals of notification messages and reset in ULDP can be configured by users, so that ULDP can respond faster to connection errors in different network environments.

The premise of ULDP working normally is that link works in duplex mode, which means ULDP is enabled on both ends of the link, using the same method of authentication and password.

10.2 ULDP Configuration Task Sequence

1. Enable ULDP function globally
2. Enable ULDP function on a port
3. Configure aggressive mode globally
4. Configure aggressive mode on a port
5. Configure the method to shut down unidirectional link
6. Configure the interval of Hello messages
7. Configure the interval of Recovery
8. Reset the port shut down by ULDP
9. Display and debug the relative information of ULDP

1. Enable ULDP function globally

Command	Explanation
Global configuration mode	
uldp enable uldp disable	Globally enable or disable ULDP function.

2. Enable ULDP function on a port

Command	Explanation
Port configuration mode	
uldp enable uldp disable	Enable or disable ULDP function on a port.

3. Configure aggressive mode globally

Command	Explanation
Global configuration mode	
uldp aggressive-mode no uldap aggressive-mode	Set the global working mode.

4. Configure aggressive mode on a port

Command	Explanation
Port configuration mode	
uldp aggressive-mode no uldap aggressive-mode	Set the working mode of the port.

5. Configure the method to shut down unidirectional link

Command	Explanation
Global configuration mode	
uldp manual-shutdown no uldap manual-shutdown	Configure the method to shut down unidirectional link.

6. Configure the interval of Hello messages

Command	Explanation
Global configuration mode	
uldp hello-interval <integer> no uldap hello-interval	Configure the interval of Hello messages, ranging from 5 to 100 seconds. The value is 10 seconds by default.

7. Configure the interval of Recovery

Command	Explanation
Global configuration mode	
uldp recovery-time <integer> no uldap recovery-time <integer>	Configure the interval of Recovery reset, ranging from 30 to 86400 seconds. The value is 0 second by default.

8. Reset the port shut down by ULDP

Command	Explanation
Global configuration mode or port configuration mode	
uldp reset	Reset all ports in global configuration mode; Rest the specified port in port configuration mode.

9. Display and debug the relative information of ULDP

Command	Explanation
Admin mode	

show uldp [interface ethernet IFNAME]	Display ULDP information. No parameter means to display global ULDP information. The parameter specifying a port will display global information and the neighbor information of the port.
debug uldp fsm interface ethernet <IFname> no debug uldp fsm interface ethernet <IFname>	Enable or disable the debug Chassis Switch of the state machine transition information on the specified port.
debug uldp error no debug uldp error	Enable or disable the debug Chassis Switch of error information.
debug uldp event no debug uldp event	Enable or disable the debug Chassis Switch of event information.
debug uldp packet {receive send} no debug uldp packet {receive send}	Enable or disable the type of messages can be received and sent on all ports.
debug uldp {hello probe echo unidir all}[receive send] interface ethernet <IFname> no debug uldp {hello probe echo unidir all}[receive send] interface ethernet <IFname>	Enable or disable the content detail of a particular type of messages can be received and sent on the specified port.

10.3 ULDP Function Typical Examples

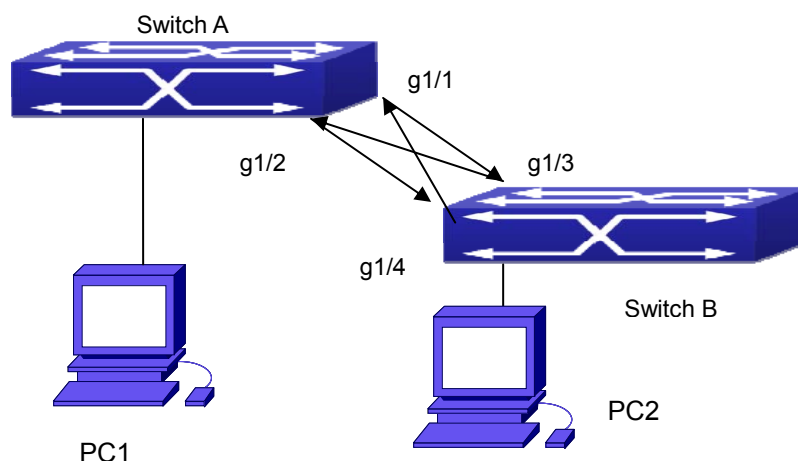

Figure 10-3-1 Fiber Cross Connection

In the network topology in Graph, port g1/1 and port g1/2 of SWITCH A as well as port g1/3 and port g1/4 of SWITCH B are all fiber ports. And the connection is cross connection. The physical layer is connected and works normally, but the data link layer is abnormal. ULDP can discover and disable this kind of error state of link. The final result is that port g1/1, g1/2 of SWITCH A and port g1/3, g1/4 of SWITCH B are all shut down by ULDP. Only when the connection is correct, can the ports work normally (won't be shut down).

```

Switch A configuration sequence:
SwitchA(config)#uldp enable
SwitchA(config)#interface ethernet 1/1
SwitchA (Config-If-Ethernet1/1)#uldp enable
SwitchA (Config-If-Ethernet1/1)#exit
SwitchA(config)#interface ethernet1/2
SwitchA(Config-If-Ethernet1/2)#uldp enable
Switch B configuration sequence:
SwitchB(config)#uldp enable
SwitchB(config)#interface ethernet1/3
SwitchB(Config-If-Ethernet1/3)#uldp enable
SwitchB(Config-If-Ethernet1/3)#exit
SwitchB(config)#interface ethernet1/4
SwitchB(Config-If-Ethernet1/4)#uldp enable

```

As a result, port g1/1, g1/2 of SWITCH A are all shut down by ULDP, and there is notification information on the CRT terminal of PC1.

```

%Oct 29 11:09:50 2007 A unidirectional link is detected! Port Ethernet1/1 need to be shutted down!
%Oct 29 11:09:50 2007 Unidirectional port Ethernet1/1 shut down!
%Oct 29 11:09:50 2007 A unidirectional link is detected! Port Ethernet1/2 need to be shutted down!
%Oct 29 11:09:50 2007 Unidirectional port Ethernet1/2 shutted down!

```

Port g1/3, and port g1/4 of SWITCH B are all shut down by ULDP, and there is notification information on the CRT terminal of PC2.

```

%Oct 29 11:09:50 2007 A unidirectional link is detected! Port Ethernet1/3 need to be shutted down!
%Oct 29 11:09:50 2007 Unidirectional port Ethernet1/3 shutted down!
%Oct 29 11:09:50 2007 A unidirectional link is detected! Port Ethernet1/4 need to be shutted down!
%Oct 29 11:09:50 2007 Unidirectional port Ethernet1/4 shutted down!

```

10.4 ULDP Troubleshooting

Configuration Notice:

- In order to ensure that ULDP can discover that the one of fiber ports has not connected or the ports are incorrectly cross connected, the ports have to work in duplex mode and have the same rate.
- If the automatic negotiation mechanism of the fiber ports with one port misconnected decides the working mode and rate of the ports, ULDP won't take effect no matter enabled or not. In such situation, the port is considered as "Down".
- In order to make sure that neighbors can be correctly created and unidirectional links can be correctly discovered, it is required that both end of the link should enable ULDP, using the same authentication method and password. At present, no password is needed on both ends.
- The hello interval of sending hello messages can be changed (it is 10 seconds by default and ranges from 5 to 100 seconds) so that ULDP can respond faster to connection errors of links in different network environments. But this interval should be less than 1/3 of the STP convergence time. If the

interval is too long, a STP loop will be generated before ULDP discovers and shuts down the unidirectional connection port. If the interval is too short, the network burden on the port will be increased, which means a reduced bandwidth.

- ULDP does not handle any LACP event. It treats every link of TRUNK group (like Port-channel, TRUNK ports) as independent, and handles each of them respectively.
- ULDP does not compact with similar protocols of other vendors, which means users can not use ULDP on one end and use other similar protocols on the other end.
- ULDP function is disabled by default. After globally enabling ULDP function, the debug switch can be enabled simultaneously to check the debug information. There are several DEBUG commands provided to print debug information, such as information of events, state machine, errors and messages. Different types of message information can also be printed according to different parameters.
- The Recovery timer is disabled by default and will only be enabled when the users have configured recovery time (30-86400 seconds).
- Reset command and reset mechanism can only reset the ports automatically shut down by ULDP. The ports shut down manually by users or by other modules won't be reset by ULDP.

Chapter 11 LLDP Function Operation Configuration

11.1 Introduction to LLDP Function

Link Layer Discovery Protocol (LLDP) is a new protocol defined in 802.1ab. It enables neighbor devices to send notices of their own state to other devices, and enables all ports of every device to store information about them. If necessary, the ports can also send update information to the neighbor devices directly connected to them, and those neighbor devices will store the information in standard SNMP MIBs. The network management system can check the layer-two connection state from MIB. LLDP won't configure or control network elements or flows, but only report the configuration of layer-two. Another content of 802.1ab is to utilizing the information provided by LLDP to find the conflicts in layer-two. IEEE now uses the existing physical topology, interfaces and Entity MIBs of IETF.

To simplify, LLDP is a neighbor discovery protocol. It defines a standard method for Ethernet devices, such as switches, routers and WLAN access points, to enable them to notify their existence to other nodes in the network and store the discovery information of all neighbor devices. For example, the detail information of the device configuration and discovery can both use this protocol to advertise.

In specific, LLDP defines a general advertisement information set, a transportation advertisement protocol and a method to store the received advertisement information. The device to advertise its own information can put multiple pieces of advertisement information in one LAN data packet to transport. The type of transportation is the **type length value (TLV)** field. All devices supporting LLDP have to support device ID and port ID advertisement, but it is assumed that, most devices should also support system name, system description and system performance advertisement. System name and system description advertisement can also provide useful information for collecting network flow data. System description advertisement can include data such as the full name of the advertising device, hardware type of system, the version information of software operation system and so on.

802.1AB Link Layer Discovery Protocol will make searching the problems in an enterprise network an easier process and can strengthen the ability of network management tools to discover and maintain accurate network topology structure.

Many kinds of network management software use "Automated Discovery" function to trace the change and condition of topology, but most of them can reach layer-three and classify the devices into all IP subnets at best. This kind of data are very primitive, only referring to basic events like the adding and removing of relative devices instead of details about where and how these devices operate with the network.

Layer 2 discovery covers information like which devices have which ports, which switches connect to other devices and so on, it can also display the routs between clients, switches, routers, application servers and network servers. Such details will be very meaningful for schedule and investigate the source of network failure.

LLDP will be a very useful management tool, providing accurate information about network mirroring, flow data and searching network problems.

11.2 LLDP Function Configuration Task Sequence

1. Globally enable LLDP function
2. Configure the port-based LLDP function switch
3. Configure the operating state of port LLDP
4. Configure the intervals of LLDP updating messages
5. Configure the aging time multiplier of LLDP messages
6. Configure the sending delay of updating messages
7. Configure the intervals of sending Trap messages
8. Configure to enable the Trap function of the port
9. Configure the optional information-sending attribute of the port
10. Configure the size of space to store Remote Table of the port
11. Configure the type of operation when the Remote Table of the port is full
12. Display and debug the relative information of LLDP

1. Globally enable LLDP function

Command	Explanation
Global Mode	
lldp enable lldp disable	Globally enable or disable LLDP function.

2. Configure the port-base LLDP function switch

Command	Explanation
Port Mode	
lldp enable lldp disable	Configure the port-base LLDP function switch.

3. Configure the operating state of port LLDP

Command	Explanation
Port Mode	
lldp mode (send receive both disable)	Configure the operating state of port LLDP.

4. Configure the intervals of LLDP updating messages

Command	Explanation
Global Mode	
lldp tx-interval <integer> no lldp tx-interval	Configure the intervals of LLDP updating messages as the specified value or default value.

5. Configure the aging time multiplier of LLDP messages

Command	Explanation
Global Mode	

lldp msgTxHold <value> no lldp msgTxHold	Configure the aging time multiplier of LLDP messages as the specified value or default value.
---	---

6. Configure the sending delay of updating messages

Command	Explanation
Global Mode	
lldp transmit delay <seconds> no lldp transmit delay	Configure the sending delay of updating messages as the specified value or default value.

7. Configure the intervals of sending Trap messages

Command	Explanation
Global Mode	
lldp notification interval <seconds> no lldp notification interval	Configure the intervals of sending Trap messages as the specified value or default value.

8. Configure to enable the Trap function of the port

Command	Explanation
Port Configuration Mode	
lldp trap <enable/disable>	Enable or disable the Trap function of the port.

9. Configure the optional information-sending attribute of the port

Command	Explanation
Port Configuration Mode	
lldp transmit optional tlv [portDesc] [sysName] [sysDesc] [sysCap] no lldp transmit optional tlv	Configure the optional information-sending attribute of the port as the option value of default values.

10. Configure the size of space to store Remote Table of the port

Command	Explanation
Port Configuration Mode	
lldp neighbors max-num < value > no lldp neighbors max-num	Configure the size of space to store Remote Table of the port as the specified value or default value.

11. Configure the type of operation when the Remote Table of the port is full

Command	Explanation
Port Configuration Mode	
lldp tooManyNeighbors {discard delete}	Configure the type of operation when the Remote Table of the port is full.

12. Display and debug the relative information of LLDP

Command	Explanation
Admin, Global Mode	
show lldp	Display the current LLDP configuration information.
show lldp interface ethernet <IFNAME>	Display the LLDP configuration information of the current port.
show lldp traffic	Display the information of all kinds of counters.
show lldp neighbors interface ethernet < IFNAME >	Display the information of LLDP neighbors of the current port.
show debugging lldp	Display all ports with LLDP debug enabled.
Admin Mode	
debug lldp no debug lldp	Enable or disable the DEBUG switch.
debug lldp packets interface ethernet <IFNAME> no debug lldp packets interface ethernet <IFNAME>	Enable or disable the DEBUG packet-receiving and sending function in port or global mode.
Port configuration mode	
clear lldp remote-table	Clear Remote-table of the port.

11.3 LLDP Function Typical Example

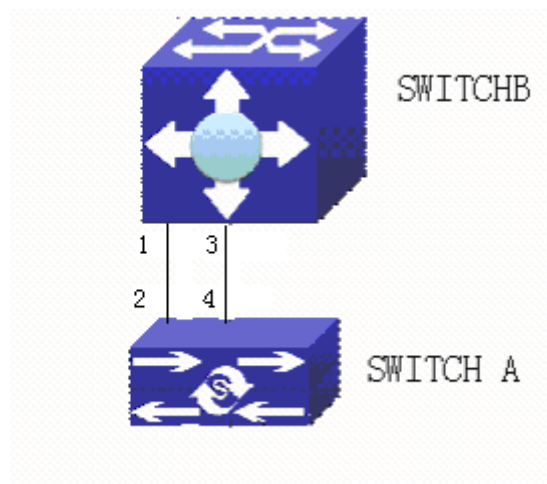

Figure 11-3-1 LLDP Function Typical Configuration Example

In the network topology graph above, the port 1,3 of SWITCH B are connected to port 2,4 of SWITCH A. Port 1 of SWITCH B is configured to message-receiving-only mode, Option TLV of port 4 of SWITCH A is configured as portDes and SysCap.

SWITCH A configuration task sequence:

```
Switch A(config)# lldp enable
Switch A(config)#interface ethernet 1/4
Switch A(Config-If-Ethernet1/4)# lldp transmit optional tlv portDesc sysCap
```



```
Switch A(Config-If-Ethernet1/4)exit
```

SWITCH B configuration task sequence:

```
Switch B(config)#lldp enable
Switch B(config)#interface ethernet1/1
Switch B(Config-If-Ethernet1/1)#lldp mode receive
Switch B(Config-If-Ethernet1/1)#exit
```

11.4 LLDP Function Troubleshooting

- LLDP function is disabled by default. After enabling the global switch of LLDP, users can enable the debug switch “**debug lldp**” simultaneously to check debug information.
- Using “show” function of LLDP function can display the configuration information in global or port configuration mode.

Chapter 12 Port Channel Configuration

12.1 Introduction to Port Channel

To understand Port Channel, Port Group should be introduced first. Port Group is a group of physical ports in the configuration level; only physical ports in the Port Group can take part in link aggregation and become a member port of a Port Channel. Logically, Port Group is not a port but a port sequence. Under certain conditions, physical ports in a Port Group perform port aggregation to form a Port Channel that has all the properties of a logical port, therefore it becomes an independent logical port. Port aggregation is a process of logical abstraction to abstract a set of ports (port sequence) with the same properties to a logical port. Port Channel is a collection of physical ports and used logically as one physical port. Port Channel can be used as a normal port by the user, and can not only add network's bandwidth, but also provide link backup. Port aggregation is usually used when the switch is connected to routers, PCs or other switches.

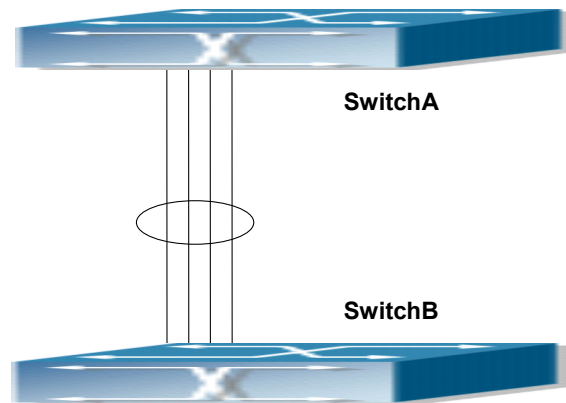

Figure 12-1-1 Port aggregation

As shown in the above, SwitchA is aggregated to a Port Channel, the bandwidth of this Port Channel is the total of all the four ports. If traffic from SwitchA needs to be transferred to SwitchB through the Port Channel, traffic allocation calculation will be performed based on the source MAC address and the lowest bit of target MAC address. The calculation result will decide which port to convey the traffic. If a port in Port Channel fails, the other ports will undertake traffic of that port through a traffic allocation algorithm. This algorithm is carried out by the hardware.

Chassis Switch offers two methods for configuring port aggregation: manual Port Channel creation and LACP (Link Aggregation Control Protocol) dynamic Port Channel creation. Port aggregation can only be performed on ports in full-duplex mode.

For Port Channel to work properly, member ports of the Port Channel must have the same properties as follows:

- All ports are in full-duplex mode.
- All Ports are of the same speed.
- All ports are Access ports and belong to the same VLAN or are all TRUNK ports, or are all Hybrid ports.
- If the ports are all TRUNK ports or Hybrid ports , then their "Allowed VLAN" and "Native VLAN" property should also be the same.

If Port Channel is configured manually or dynamically on switch, the system will automatically set the port with the smallest number to be Master Port of the Port Channel. If the spanning tree function is enabled in the Chassis Switch, the spanning tree protocol will regard Port Channel as a logical port and send BPDU frames via the master port.

Port aggregation is closely related with Chassis Switch hardware. Chassis Switch allow physical port aggregation of any two switches, maximum 128 port groups and 8 ports in each port group are supported.

Once ports are aggregated, they can be used as a normal port. Chassis Switch have a built-in aggregation interface configuration mode, the user can perform related configuration in this mode just like in the VLAN and physical port configuration mode.

12.2 Brief Introduction to LACP

LACP (Link Aggregation Control Protocol) is a kind of protocol based on IEEE802.3ad standard to implement the link dynamic aggregation. LACP protocol uses LACPDU (Link Aggregation Control Protocol Data Unit) to exchange the information with the other end.

After LACP protocol of the port is enabled, this port will send LACPDU to the other end to notify the system priority, the MAC address of the system, the priority of the port, the port ID and the operation Key. After the other end receives the information, the information is compared with the saving information of other ports to select the port which can be aggregated, accordingly, both sides can reach an agreement about the ports join or exit the dynamic aggregation group.

The operation Key is created by LACP protocol according to the combination of configuration (speed, duplex, basic configuration, management Key) of the ports to be aggregated.

After the dynamic aggregation port enables LACP protocol, the management Key is 0 by default. After the static aggregation port enables LACP, the management Key of the port is the same with the ID of the aggregation group.

For the dynamic aggregation group, the members of the same group have the same operation Key, for the static aggregation group, the ports of Active have the same operation Key.

The port aggregation is that multi-ports are aggregated to form an aggregation group, so as to implement the out/in load balance in each member port of the aggregation group and provides the better reliability.

12.2.1 Static LACP Aggregation

Static LACP aggregation is enforced by users configuration, and do not enable LACP protocol. When configuring static LACP aggregation, use “on” mode to force the port to enter the aggregation group.

12.2.2 Dynamic LACP Aggregation

1. The summary of the dynamic LACP aggregation

Dynamic LACP aggregation is an aggregation created/deleted by the system automatically, it does not allow the user to add or delete the member ports of the dynamic LACP aggregation. The ports which have the same attribute of speed and duplex, are connected to the same device, have the same basic configuration, can be dynamically aggregated together. Even if only one port can create the dynamic aggregation, that is the single port aggregation. In the dynamic aggregation, LACP protocol of the port is at the enable state.

2. The port state of the dynamic aggregation group

In dynamic aggregation group, the ports have two states: selected or standby. Both selected ports and standby ports can receive and send LACP protocol, but standby ports can not forward the data packets.

Because the limitation of the max port number in the aggregation group, if the current number of the member ports exceeds the limitation of the max port number, then the system of this end will negotiate with the other end to decide the port state according to the port ID. The negotiation steps are as follows:

Compare ID of the devices (the priority of the system + the MAC address of the system). First, compare the priority of the systems, if they are same, then compare the MAC address of the systems. The end with a small device ID has the high priority.

Compare the ID of the ports (the priority of the port + the ID of the port). For each port in the side of the device which has the high device priority, first, compare the priority of the ports, if the priorities are same, then compare the ID of the ports. The port with a small port ID is selected, and the others become the standby ports.

In an aggregation group, the port which has the smallest port ID and is at the selected state will be the master port, the other ports at the selected state will be the member port.

12.3 Port Channel Configuration Task List

1. Create a port group in Global Mode.
2. Add ports to the specified group from the Port Mode of respective ports.
3. Enter port-channel configuration mode.
4. Set load-balance method for Port-group
5. Set the system priority of LACP protocol
6. Set the port priority of the current port in LACP protocol

1. Creating a port group

Command	Explanation
Global Mode	
port-group <port-group-number> no port-group <port-group-number>	Creates or deletes a port group.

2. Add physical ports to the port group

Command	Explanation
Port Mode	
port-group <port-group-number> mode {active passive on} no port-group	Adds ports to the port group and sets their mode.

3. Enter port-channel configuration mode.

Command	Explanation
Global Mode	
interface port-channel <port-channel-number>	Enters port-channel configuration mode.

4. Set load-balance method for Port-group

Command	Explanation
Aggregation port configuration mode	
load-balance {src-mac dst-mac dst-src-mac src-ip dst-ip dst-src-ip}	Set load-balance for port-group.

5. Set the system priority of LACP protocol

Command	Explanation
Global mode	
lacp system-priority <system-priority> no lacp system-priority	Set the system priority of LACP protocol, the no command restores the default value.

6. Set the port priority of the current port in LACP protocol

Command	Explanation
Port mode	
lacp port-priority <port-priority> no lacp port-priority	Set the port priority in LACP protocol. The no command restores the default value.

12.4 Port Channel Examples

Scenario 1: Configuring Port Channel in LACP.

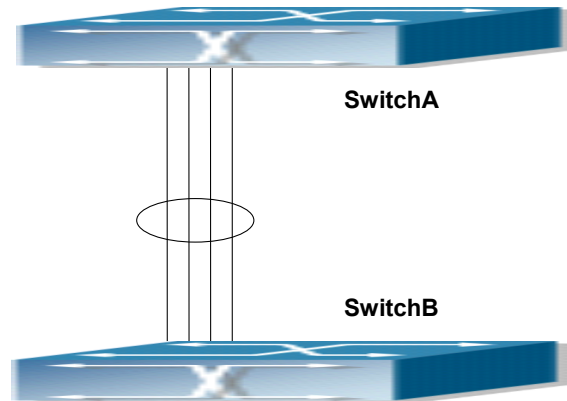

Figure 12-4-1 Configuring Port Channel in LACP

The switches in the description below are all switch and as shown in the figure, ports 1, 2, 3, 4 of SwitchA are access ports that belong to VLAN1. Add those four ports to group1 in active mode. Ports 6, 8, 9, 10 of SwitchB are access ports that also belong to VLAN1. Add these four ports to group2 in passive mode. All the ports should be connected with cables.

The configuration steps are listed below:

```
SwitchA#config
SwitchA (config)#interface ethernet 1/1-4
SwitchA (Config-If-Port-Range)#port-group 1 mode active
SwitchA (Config-If-Port-Range)#exit
SwitchA (config)#interface port-channel 1
SwitchA (Config-If-Port-Channel1)#

SwitchB#config
SwitchB (config)#port-group 2
SwitchB (config)#interface ethernet 1/6
SwitchB (Config-If-Ethernet1/6)#port-group 2 mode passive
SwitchB (Config-If-Ethernet1/6)#exit
SwitchB (config)#interface ethernet 1/8-10
SwitchB (Config-If-Port-Range)#port-group 2 mode passive
SwitchB (Config-If-Port-Range)#exit
SwitchB (config)#interface port-channel 2
SwitchB (Config-If-Port-Channel2)#
```

Configuration result:

Shell prompts ports aggregated successfully after a while, now ports 1, 2, 3, 4 of Switch A form an aggregated port named "Port-Channel1", ports 6, 8, 9, 10 of Switch B forms an aggregated port named "Port-Channel2"; configurations can be made in their respective aggregated port configuration mode.

Scenario 2: Configuring Port Channel in ON mode.

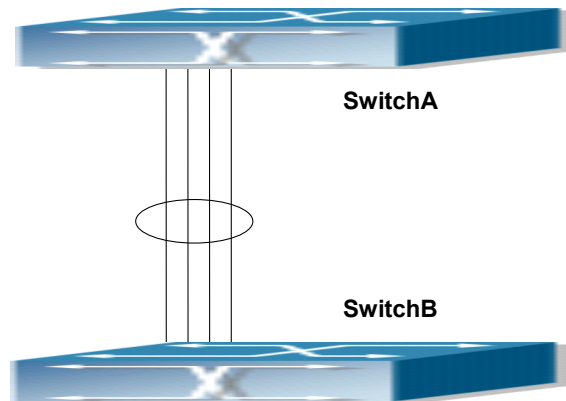

Figure 12-4-2 Configuring Port Channel in ON mode

Example: As shown in the figure, ports 1, 2, 3, 4 of SwitchA are access ports that belong to VLAN1. Add those four ports to group1 in “on” mode. Ports 6, 8, 9, 10 of SwitchB are access ports that also belong to VLAN1, add these four ports to group2 in “on” mode.

The configuration steps are listed below:

```
SwitchA#config
SwitchA (config)#interface ethernet 1/1
SwitchA (Config-If-Ethernet1/1)#port-group 1 mode on
SwitchA (Config-If-Ethernet1/1)#exit
SwitchA (config)#interface ethernet 1/2
SwitchA (Config-If-Ethernet1/2)#port-group 1 mode on
SwitchA (Config-If-Ethernet1/2)#exit
SwitchA (config)#interface ethernet 1/3
SwitchA (Config-If-Ethernet1/3)#port-group 1 mode on
SwitchA (Config-If-Ethernet1/3)#exit
SwitchA (config)#interface ethernet 1/4
SwitchA (Config-If-Ethernet1/4)#port-group 1 mode on
SwitchA (Config-If-Ethernet1/4)#exit

SwitchB#config
SwitchB (config)#port-group 2
SwitchB (config)#interface ethernet 1/6
SwitchB (Config-If-Ethernet1/6)#port-group 2 mode on
SwitchB (Config-If-Ethernet1/6)#exit
SwitchB (config)#interface ethernet 1/8-10
SwitchB (Config-If-Port-Range)#port-group 2 mode on
SwitchB (Config-If-Port-Range)#exit
```

Configuration result:

Add ports 1, 2, 3, 4 of Switch 1 to port-group 1 in order, and we can see a group in “on” mode is completely joined forcedly, Chassis Switch in other ends won’t exchange LACP BPDU to complete aggregation. Aggregation finishes immediately when the command to add port 2 to port-group 1 is entered, port 1 and port 2 aggregate to be port-channel 1, when port 3 joins port-group 1, port-channel 1 of port 1 and 2 are ungrouped and re-aggregate with port 3 to form port-channel 1, when port 4 joins port-group 1, port-channel 1 of port 1, 2 and 3 are ungrouped and re-aggregate with port 4 to form port-channel 1. (It should be noted that whenever a new port joins in an aggregated port group, the group will be ungrouped first and re-aggregated to form a new group.) Now all four ports in both SwitchA and SwitchB are aggregated in “on” mode and become an aggregated port respectively.

12.5 Port Channel Troubleshooting

If problems occur when configuring port aggregation, please first check the following for causes.

- Ensure all ports in a port group have the same properties, i.e., whether they are in full-duplex mode, forced to the same speed, and have the same VLAN properties, etc. If inconsistency occurs, make corrections.
- Some commands cannot be used on a port in port-channel, such as arp, bandwidth, ip, ip-forward, etc.

Chapter 13 Jumbo Configuration

13.1 Introduction to Jumbo

So far the Jumbo (Jumbo Frame) has not reach a determined standard in the industry (including the format and length of the frame). Normally frames sized within 1519-9000 should be considered jumbo frame. Networks with jumbo frames will increase the speed of the whole network by 2% to 5%. Technically the Jumbo is just a lengthened frame sent and received by the switch. However considering the length of Jumbo frames, they will not be sent to CPU. We discarded the Jumbo frames sent to CPU in the packet receiving process.

13.2 Jumbo Configuration Task Sequence

1. Configure enable Jumbo function

Command	Explanation
Global Mode	
jumbo enable [<mtu-value>] no jumbo enable	Enable sending/receiving function of the Jumbo frames. The no command disables sending and receiving function of the Jumbo frames.

Chapter 14 VLAN Configuration

14.1 VLAN Configuration

14.1.1 Introduction to VLAN

VLAN (Virtual Local Area Network) is a technology that divides the logical addresses of devices within the network to separate network segments basing on functions, applications or management requirements. By this way, virtual workgroups can be formed regardless of the physical location of the devices. IEEE announced IEEE 802.1Q protocol to direct the standardized VLAN implementation, and the VLAN function of Chassis Switch is implemented following IEEE 802.1Q.

The key idea of VLAN technology is that a large LAN can be partitioned into many separate broadcast domains dynamically to meet the demands.

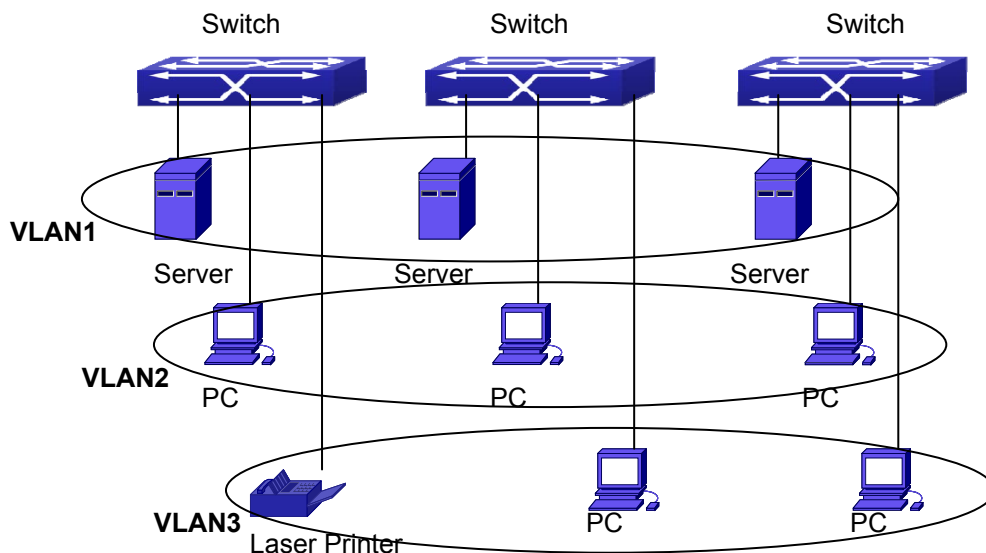

Figure 14-1-1 A VLAN network defined logically

Each broadcast domain is a VLAN. VLANs have the same properties as the physical LANs, except VLAN is a logical partition rather than physical one. Therefore, the partition of VLANs can be performed regardless of physical locations, and the broadcast, multicast and unicast traffic within a VLAN is separated from the other VLANs.

With the aforementioned features, VLAN technology provides us with the following convenience:

- Improving network performance
- Saving network resources
- Simplifying network management
- Lowering network cost
- Enhancing network security

XGS3 Chassis Switch Ethernet Ports can work in three kinds of modes: Access, Hybrid and Trunk, each mode has a different processing method in forwarding the packets with tagged or untagged.

The ports of Access type only belong to one VLAN, usually they are used to connect the ports of the computer.

The ports of Trunk type allow multi-VLANs to pass, can receive and send the packets of multi-VLANs. Usually they are used to connect between the switches.

The ports of Hybrid type allow multi-VLANs to pass, can receive and send the packets of multi-VLANs. They can be used to connect between the switches, or to a computer of the user.

Hybrid ports and Trunk ports receive the data with the same process method, but send the data with different method: Hybrid ports can send the packets of multi-VLANs without the VLAN tag, while Trunk ports send the packets of multi-VLANs with the VLAN tag except the port native VLAN.

The Chassis Switch implements VLAN and GVRP (GARP VLAN Registration Protocol) which are defined by 802.1Q. The chapter will explain the use and the configuration of VLAN and GVRP in detail.

14.1.2 VLAN Configuration Task List

1. Create or delete VLAN
2. Set or delete VLAN name
3. Assign Switch ports for VLAN
4. Set the switch port type
5. Set Trunk port
6. Set Access port
7. Set Hybrid port
8. Enable/Disable VLAN ingress rules on ports
9. Configure Private VLAN
10. Set Private VLAN association

1. Create or delete VLAN

Command	Explanation
Global Mode	
vlan WORD no vlan WORD	Create/delete VLAN or enter VLAN Mode

2. Set or delete VLAN name

Command	Explanation
Global Mode	
name <vlan-name> no name	Set or delete VLAN name.

3. Assigning Switch ports for VLAN

Command	Explanation
VLAN Mode	

switchport interface <interface-list> no switchport interface <interface-list>	Assign Chassis Switch ports to VLAN.
---	--------------------------------------

4. Set the Switch Port Type

Command	Explanation
Port Mode	
switchport mode {trunk access hybrid}	Set the current port as Trunk, Access Hybrid port.

5. Set Trunk port

Command	Explanation
Port Mode	
switchport trunk allowed vlan {WORD all add WORD except WORD remove WORD} no switchport trunk allowed vlan	Set/delete VLAN allowed to be crossed by Trunk. The “no” command restores the default setting.
switchport trunk native vlan <vlan-id> no switchport trunk native vlan	Set/delete PVID for Trunk port.

6. Set Access port

Command	Explanation
Port Mode	
switchport access vlan <vlan-id> no switchport access vlan	Add the current port to the specified VLAN. The “no” command restores the default setting.

7. Set Hybrid port

Command	Explanation
Port Mode	
switchport hybrid allowed vlan {WORD all add WORD except WORD remove WORD} {tag untag} no switchport hybrid allowed vlan	Set/delete the VLAN which is allowed by Hybrid port with tag or untag mode.
switchport hybrid native vlan <vlan-id> no switchport hybrid native vlan	Set/delete PVID of the port.

8. Disable/Enable VLAN Ingress Rules

Command	Explanation
Port Mode	
vlan ingress enable no vlan ingress enable	Enable/Disable VLAN ingress rules.

9. Configure Private VLAN

Command	Explanation
VLAN mode	

private-vlan {primary isolated community} no private-vlan	Configure current VLAN to Private VLAN. The no command deletes private VLAN.
--	---

10. Set Private VLAN association

Command	Explanation
VLAN mode	
private-vlan association <secondary-vlan-list> no private-vlan association	Set/delete Private VLAN association.

14.1.3 Typical VLAN Application

Scenario:

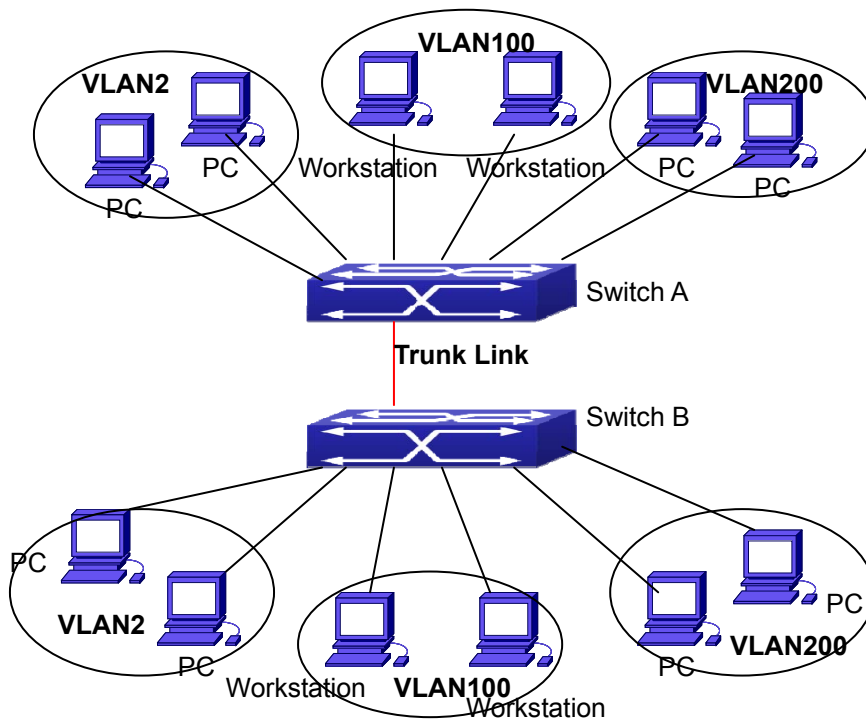

Figure 14-1-2 Typical VLAN Application Topology

The existing LAN is required to be partitioned to 3 VLANs due to security and application requirements. The three VLANs are VLAN2, VLAN100 and VLAN200. Those three VLANs are cross two different location A and B. One switch is placed in each site, and cross-location requirement can be met if VLAN traffic can be transferred between the two switches.

Configuration Item	Configuration description
VLAN2	Site A and site B switch port 2 -4.
VLAN100	Site A and site B switch port 5 -7.
VLAN200	Site A and site B switch port 8 -10.
Trunk port	Site A and site B switch port 11.

Connect the Trunk ports of both switches for a Trunk link to convey the cross-switch VLAN traffic; connect all network devices to the other ports of corresponding VLANs.

In this example, port 1 and port 12 is spared and can be used for management port or for other purposes.

The configuration steps are listed below:

Switch A:

```
XGS3-42000R(config)#vlan 2
XGS3-42000R(config-Vlan2)#switchport interface ethernet 1/2-4
XGS3-42000R(config-Vlan2)#exit
XGS3-42000R(config)#vlan 100
XGS3-42000R(config-Vlan100)#switchport interface ethernet 1/5-7
XGS3-42000R(config-Vlan100)#exit
XGS3-42000R(config)#vlan 200
XGS3-42000R(config-Vlan200)#switchport interface ethernet 1/8-10
XGS3-42000R(config-Vlan200)#exit
XGS3-42000R(config)#interface ethernet 1/11
XGS3-42000R(config-If-Ethernet1/11)#switchport mode trunk
XGS3-42000R(config-If-Ethernet1/11)#exit
XGS3-42000R(config)#
```

Switch B:

```
XGS3-42000R(config)#vlan 2
XGS3-42000R(config-Vlan2)#switchport interface ethernet 1/2-4
XGS3-42000R(config-Vlan2)#exit
XGS3-42000R(config)#vlan 100
XGS3-42000R(config-Vlan100)#switchport interface ethernet 1/5-7
XGS3-42000R(config-Vlan100)#exit
XGS3-42000R(config)#vlan 200
XGS3-42000R(config-Vlan200)#switchport interface ethernet 1/8-10
XGS3-42000R(config-Vlan200)#exit
XGS3-42000R(config)#interface ethernet 1/11
XGS3-42000R(config-If-Ethernet1/11)#switchport mode trunk
XGS3-42000R(config-If-Ethernet1/11)#exit
```

14.1.4 Typical Application of Hybrid Port

Scenario:

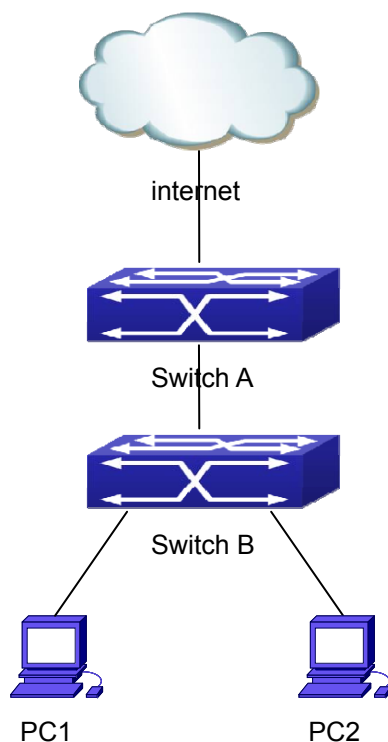

Figure 14-1-3 Typical Application of Hybrid Port

PC1 connects to the interface Ethernet 1/7 of SwitchB, PC2 connects to the interface Ethernet 1/9 of SwitchB, Ethernet 1/10 of SwitchA connect to Ethernet 1/10 of SwitchB.

It is required that PC1 and PC2 can not mutually access due to reason of the security, but PC1 and PC2 can access other network resources through the gateway SwitchA. We can implement this status through Hybrid port.

Configuration items are as follows:

Port	Type	PVID	the VLANs are allowed to pass
Port 1/10 of Switch A	Access	10	Allow the packets of VLAN 10 to pass with untag method.
Port 1/10 of Switch B	Hybrid	10	Allow the packets of VLAN 7, 9, 10 to pass with untag method.
Port 1/7 of Switch B	Hybrid	7	Allow the packets of VLAN 7, 10 to pass with untag method.
Port 1/9 of Switch B	Hybrid	9	Allow the packets of VLAN 9, 10 to pass with untag method.

The configuration steps are listed below:

Switch A:

```
XGS3-42000R(config)#vlan 10
XGS3-42000R(Config-Vlan10)#switchport interface ethernet 1/10
```

Switch B:

```
XGS3-42000R(config)#vlan 7;9;10
XGS3-42000R(config)#interface ethernet 1/7
XGS3-42000R(Config-If-Ethernet1/7)#switchport mode hybrid
XGS3-42000R(Config-If-Ethernet1/7)#switchport hybrid native vlan 7
XGS3-42000R(Config-If-Ethernet1/7)#switchport hybrid allowed vlan 7;10 untag
XGS3-42000R(Config-If-Ethernet1/7)#exit
XGS3-42000R(Config)#interface Ethernet 1/9
XGS3-42000R(Config-If-Ethernet1/9)#switchport mode hybrid
XGS3-42000R(Config-If-Ethernet1/9)#switchport hybrid native vlan 9
XGS3-42000R(Config-If-Ethernet1/9)#switchport hybrid allowed vlan 9;10 untag
XGS3-42000R(Config-If-Ethernet1/9)#exit
XGS3-42000R(Config)#interface Ethernet 1/10
XGS3-42000R(Config-If-Ethernet1/10)#switchport mode hybrid
XGS3-42000R(Config-If-Ethernet1/10)#switchport hybrid native vlan 10
XGS3-42000R(Config-If-Ethernet1/10)#switchport hybrid allowed vlan 7;9;10 untag
XGS3-42000R(Config-If-Ethernet1/10)#exit
```

14.2 GVRP Configuration

14.2.1 Introduction to GVRP

GARP (Generic Attribute Registration Protocol) can be used to dynamically distribute, populate and register property information between switch members within a Chassis Switch network, the property can be VLAN information, Multicast MAC address of the other information. As a matter of fact, GARP protocol can convey multiple property features the Chassis Switch need to populate. Various GARP applications are defined on the basis of GARP, which are called GARP application entities, and GVRP is one of them.

GVRP (GARP VLAN Registration Protocol) is an application based on GARP working mechanism. It is responsible for the maintenance of dynamic VLAN register information and population of such register information to the other switches. Switches support GVRP can receive VLAN dynamic register information from the other switches, and update local VLAN register information according the information received. The switch enabled GVRP can also populate their own VLAN register information to the other switches. The populated VLAN register information includes local static information manually configured and dynamic information learnt from the other switches. Therefore, by populating the VLAN register information, VLAN information consistency can be achieved among all GVRP enabled switches.

14.2.2 GVRP Configuration Task List

1. Configuring GARP Timer parameters

Command	Explanation
Port Mode	
garp timer join <timer-value> no garp timer join garp timer leave <timer-value> no garp timer leave garp timer hold <timer-value> no garp timer hold	Configure the hold, join and leave timers for GARP.
Global Mode	
garp timer leaveall <timer-value> no garp timer leaveall	Configure the leave all timer for GARP.

2. Enable GVRP function

Command	Explanation
Port Mode	
gvrp no gvrp	Enable/disable the GVRP function on current port.
Global Mode	
gvrp no gvrp	Enable/disable the GVRP function for the switch.

14.2.3 Typical GVRP Application

Scenario:

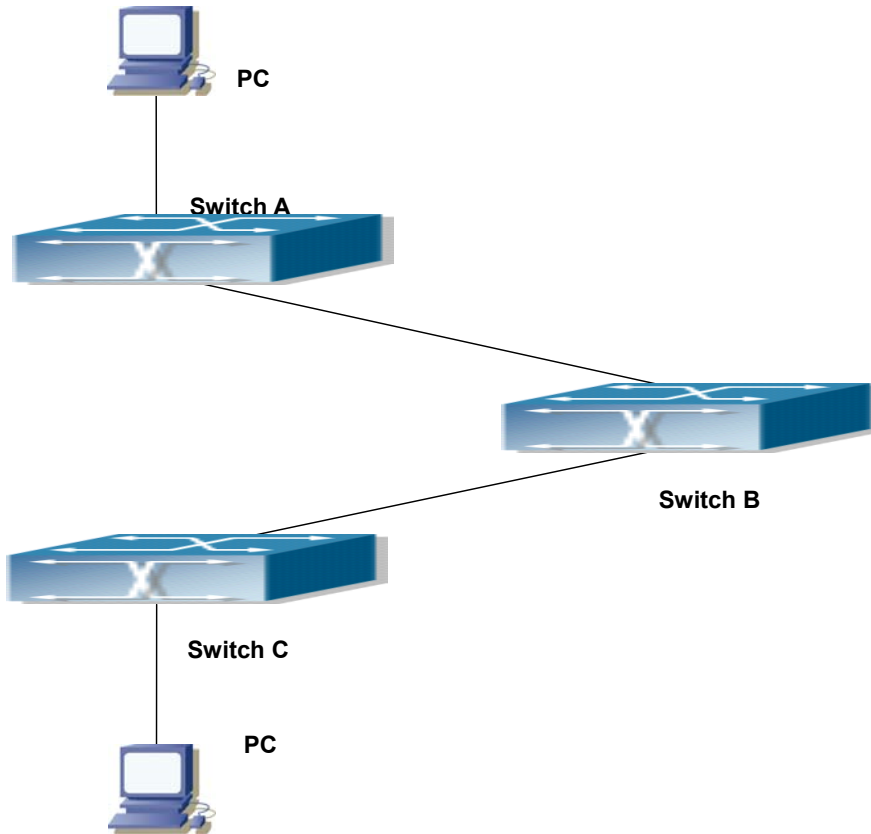

Figure 14-2-1 Typical GVRP Application Topology

To enable dynamic VLAN information register and update among switches, GVRP protocol is to be configured in the Chassis Switch. Configure GVRP in Switch A, B and C, enable Switch B to learn VLAN100 dynamically so that the two workstation connected to VLAN100 in Switch A and C can communicate with each other through Switch B without static VLAN100 entries.

Configuration Item	Configuration description
VLAN100	Port 2 -6 of Switch A and C.
Trunk port	Port 11 of Switch A and C, Port 10, 11 of Switch B.
Global GVRP	Switch A, B, C.
Port GVRP	Port 11 of Switch A and C, Port 10, 11 of Switch B.

Connect the two workstation to the VLAN100 ports in switch A and B, connect port 11 of Switch A to port 10 of Switch B, and port 11 of Switch B to port 11 of Switch C.

The configuration steps are listed below:

Switch A:

```
XGS3-42000R(config)# gvrp
XGS3-42000R(config)#vlan 100
XGS3-42000R(config-Vlan100)#switchport interface ethernet 1/2-6
XGS3-42000R(config-Vlan100)#exit
XGS3-42000R(config)#interface Ethernet 1/11
```

```
XGS3-42000R(config-If-Ethernet1/11)#switchport mode trunk
XGS3-42000R(config-If-Ethernet1/11)# gvrp
XGS3-42000R(config-If-Ethernet1/11)#exit
```

Switch B:

```
XGS3-42000R(config)# bridge-ext gvrp
XGS3-42000R(config)#interface ethernet 1/10
XGS3-42000R(config-If-Ethernet1/10)#switchport mode trunk
XGS3-42000R(config-If-Ethernet1/10)# gvrp
XGS3-42000R(config-If-Ethernet1/10)#exit
XGS3-42000R(config)#interface ethernet 1/11
XGS3-42000R(config-If-Ethernet1/11)#switchport mode trunk
XGS3-42000R(config-If-Ethernet1/11)# gvrp
XGS3-42000R(config-If-Ethernet1/11)#exit
```

Switch C:

```
XGS3-42000R(config)# gvrp
XGS3-42000R(config)#vlan 100
XGS3-42000R(config-Vlan100)#switchport interface ethernet 1/2-6
XGS3-42000R(config-Vlan100)#exit
XGS3-42000R(config)#interface ethernet 1/11
XGS3-42000R(config-If-Ethernet1/11)#switchport mode trunk
XGS3-42000R(config-If-Ethernet1/11)# gvrp
XGS3-42000R(config-If-Ethernet1/11)#exit
```

14.2.4 GVRP Troubleshooting

The GARP counter setting in for Trunk ports in both ends of Trunk link must be the same, otherwise GVRP will not work properly. It is recommended to avoid enabling GVRP and RSTP at the same time in Chassis Switch. If GVRP is to be enabled, RSTP function for the ports must be disabled first.

14.3 Dot1q-tunnel Configuration

14.3.1 Introduction to Dot1q-tunnel

Dot1q-tunnel is also called QinQ (802.1Q-in-802.1Q), which is an expansion of 802.1Q. Its dominating idea is encapsulating the customer VLAN tag (CVLAN tag) to the service provider VLAN tag (SPVLAN tag). Carrying the two VLAN tags the packet is transmitted through the backbone network of the ISP internet, so to provide a simple layer-2 tunnel for the users. It is simple and easy to manage, applicable only by static configuration, and especially adaptive to small office network or small scale metropolitan area network using layer-3 switch as backbone equipment.

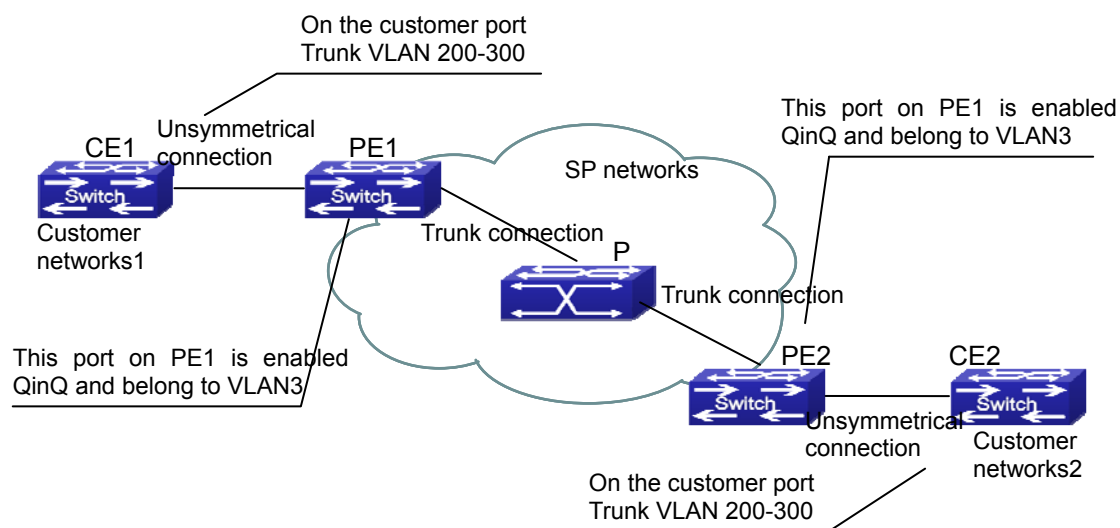

Figure 14-3-1 Dot1q-tunnel based Internetworking mode

As shown in above, after being enabled on the user port, dot1q-tunnel assigns each user an SPVLAN identification (SPVID). Here the identification of user is 3. Same SPVID should be assigned for the same network user on different PEs. When packet reaches PE1 from CE1, it carries the VLAN tag 200-300 of the user internal network. Since the dot1q-tunnel function is enabled, the user port on PE1 will add on the packet another VLAN tag, of which the ID is the SPVID assigned to the user. Afterwards, the packet will only be transmitted in VLAN3 when traveling in the ISP internet network while carrying two VLAN tags (the inner tag is added when entering PE1, and the outer is SPVID), whereas the VLAN information of the user network is open to the provider network. When the packet reaches PE2 and before being forwarded to CE2 from the client port on PE2, the outer VLAN tag is removed, then the packet CE2 receives is absolutely identical to the one sent by CE1. For the user, the role the operator network plays between PE1 and PE2, is to provide a reliable layer-2 link.

The technology of Dot1q-tunnel provides the ISP internet the ability of supporting many client VLANs by only one VLAN of their selves. Both the ISP internet and the clients can configure their own VLAN independently. It is obvious that, the dot1q-tunnel function has got following characteristics:

- Applicable through simple static configuration, no complex configuration or maintenance to be needed.
- Operators will only have to assign one SPVID for each user, which increases the number of concurrent supportable users; while the users has got the ultimate freedom in selecting and managing the VLAN IDs (select within 1~4094 at users' will).
- The user network is considerably independent. When the ISP internet is upgrading their network, the user networks do not have to change their original configuration.

Detailed description on the application and configuration of dot1q-tunnel will be provided in this section.

14.3.2 Dot1q-tunnel Configuration

Configuration Task Sequence of Dot1q-Tunnel:

1. Configure the dot1q-tunnel function on the ports

Command	Explanation
Port mode	
dot1q-tunnel enable no dot1q-tunnel enable	Enter/exit the dot1q-tunnel mode on the ports.

2. Configure the type of protocol (TPID) on the ports

Command	Explanation
Port mode	
dot1q-tunnel tpid {0x8100 0x9100 0x9200 <1-65535>}	Configure the type of protocol on TRUNK port.

14.3.3 Typical Applications of the Dot1q-tunnel

Scenario:

Edge switch PE1 and PE2 of the ISP internet forward the VLAN200~300 data between CE1 and CE2 of the client network with VLAN3. The port1 of PE1 is connected to CE1, port10 is connected to public network, the TPID of the connected equipment is 9100; port1 of PE2 is connected to CE2, port10 is connected to public network.

Configuration Item	Configuration Explanation
VLAN3	Port1 of PE1 and PE2.
dot1q-tunnel	Port1 of PE1 and PE2.
tpid	9100

Configuration procedure is as follows:

PE1:

```
XGS3-42000R(config)#vlan 3
XGS3-42000R(config-Vlan3)#switchport interface ethernet 1/1
XGS3-42000R(config-Vlan3)#exit
XGS3-42000R(config)#interface ethernet 1/1
XGS3-42000R(config-Ethernet1/1)# dot1q-tunnel enable
XGS3-42000R(config-Ethernet1/1)# exit
XGS3-42000R(config)#interface ethernet 1/10
XGS3-42000R(config-Ethernet1/10)#switchport mode trunk
XGS3-42000R(config-Ethernet1/10)#dot1q-tunnel tpid 0x9100
XGS3-42000R(config-Ethernet1/10)#exit
XGS3-42000R(config)#
```

PE2:

```
XGS3-42000R(config)#vlan 3
XGS3-42000R(config-Vlan3)#switchport interface ethernet 1/1
XGS3-42000R(config-Vlan3)#exit
XGS3-42000R(config)#interface ethernet 1/1
XGS3-42000R(config-Ethernet1/1)# dot1q-tunnel enable
```

```

XGS3-42000R(config-Ethernet1/1)# exit
XGS3-42000R(config)#interface ethernet 1/10
XGS3-42000R(config-Ethernet1/10)#switchport mode trunk
XGS3-42000R(config-Ethernet1/10)#dot1q-tunnel tpid 0x9100
XGS3-42000R(config-Ethernet1/10)#exit
XGS3-42000R(config)#

```

14.4 VLAN-translation Configuration

14.4.1 Introduction to VLAN-translation

VLAN translation, as one can tell from the name, which translates the original VLAN ID to new VLAN ID according to the user requirements so to exchange data across different VLANs. The VLAN translation is classified to ingress translation and egress translation, respectively translation the VLAN ID at the entrance or exit.

Application and configuration of VLAN translation will be explained in detail in this section.

14.4.2 VLAN-translation Configuration

Configuration task sequence of VLAN-translation:

1. Configure the VLAN-translation function on the port
2. Configure the VLAN-translation relations on the port
3. Configure the VLAN-translation packet dropped on port if there is any failure

1. Configure the VLAN-translation of the port

Command	Explanation
Port mode	
vlan-translation enable no vlan-translation enable	Enter/exit the port VLAN-translation mode.

2. Configure the VLAN-translation relation of the port

Command	Explanation
Port mode	
vlan-translation <old-vlan-id> to <new-vlan-id> {in out} no vlan-translation old-vlan-id {in out}	Add/delete a VLAN-translation relation.

3. Configure the VLAN-translation relation, check if there is any failure or packet dropped

Command	Explanation
Port mode	
vlan-translation miss drop {in out both} no vlan-translation miss drop {in out both}	Configure the VLAN-translation packet dropped on port if there is any failure.

14.4.3 Typical application of VLAN-translation

Scenario:

Edge switch PE1 and PE2 of the ISP internet support the VLAN20 data task between CE1 and CE2 of the client network with VLAN3. The port1 of PE1 is connected to CE1, port10 is connected to public network; port1 of PE2 is connected to CE2, port10 is connected to public network.

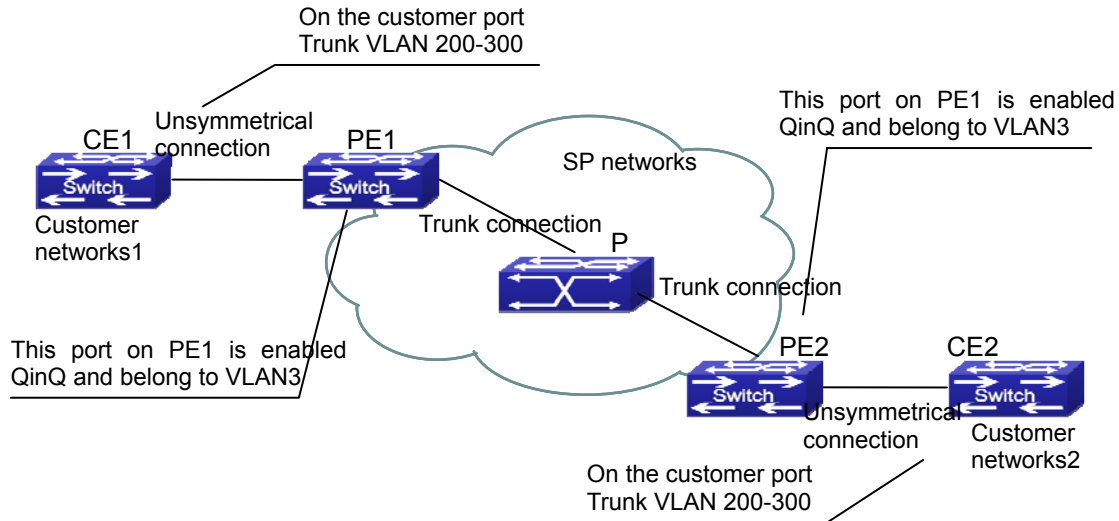

Figure 14-4-1 Vlan translation topology mode

Configuration Item	Configuration Explanation
VLAN-translation	Port1 of PE1 and PE2.
Trunk port	Port1 and Port10 of PE1 and PE2.

Configuration procedure is as follows:

PE1、PE2:

```
XGS3-42000R(config)#interface ethernet 1/1
XGS3-42000R(config-Ethernet1/1)#switchport mode trunk
XGS3-42000R(config-Ethernet1/1)# dot1q-tunnel enable
XGS3-42000R(config-Ethernet1/1)# vlan-translation enable
XGS3-42000R(config-Ethernet1/1)# vlan-translation 20 to 3 in
XGS3-42000R(config-Ethernet1/1)# vlan-translation 3 to 20 out
XGS3-42000R(config-Ethernet1/1)# exit
XGS3-42000R(config)#interface ethernet 1/10
XGS3-42000R(config-Ethernet1/10)#switchport mode trunk
XGS3-42000R(config-Ethernet1/10)#exit
XGS3-42000R(config)#
```

14.4.4 VLAN-translation Troubleshooting

- Normally the VLAN-translation is applied on trunk ports. Normally before using the VLAN-translation, the dot1q-tunnel function needs to be enabled, becoming adaptable to double tag data packet and translating the VLAN normally.

14.5 Dynamic VLAN Configuration

14.5.1 Introduction to Dynamic VLAN

The dynamic VLAN is named corresponding to the static VLAN (namely the port based VLAN). Dynamic VLAN supported by the Chassis Switch includes MAC-based VLAN, IP-subnet-based VLAN and Protocol-based VLAN. Detailed description is as follows:

The MAC-based VLAN division is based on the MAC address of each host, namely every host with a MAC address will be assigned to certain VLAN. By the means, the network user will maintain his membership in his belonging VLAN when moves from a physical location to another. As we can see the greatest advantage of this VLAN division is that the VLAN does not have to be re-configured when the user physic location change, namely shift from one switch to another, which is because it is user based, not switch port based.

The IP subnet based VLAN is divided according to the source IP address and its subnet mask of every host. It assigns corresponding VLAN ID to the data packet according to the subnet segment, leading the data packet to specified VLAN. Its advantage is the same as that of the MAC-based VLAN: the user does not have to change configuration when relocated.

The VLAN is divided by the network layer protocol, assigning different protocol to different VLANs. This is very attractive to the network administrators who wish to organize the user by applications and services. Moreover the user can move freely within the network while maintaining his membership. Advantage of this method enables user to change physical position without changing their VLAN residing configuration, while the VLAN can be divided by types of protocols which is important to the network administrators. Further, this method has no need of added frame label to identify the VLAN which reduce the network traffic.

Notice: Dynamic VLAN needs to associate with Hybrid attribute of the ports to work, so the ports that may be added to a dynamic VLAN must be configured as Hybrid port.

14.5.2 Dynamic VLAN Configuration

Dynamic VLAN Configuration Task Sequence:

1. Configure the MAC-based VLAN function on the port
2. Set the VLAN to MAC VLAN
3. Configure the correspondence between the MAC address and the VLAN
4. Configure the IP-subnet-based VLAN function on the port
5. Configure the correspondence between the IP subnet and the VLAN
6. Configure the correspondence between the Protocols and the VLAN
7. Adjust the priority of the dynamic VLAN

1. Configure the MAC-based VLAN function on the port

Command	Explanation
Port Mode	
switchport mac-vlan enable no switchport mac-vlan enable	Enable/disable the MAC-based VLAN function on the port.

2. Set the VLAN to MAC VLAN

Command	Explanation
Global Mode	
mac-vlan vlan <vlan-id> no mac-vlan	Configure the specified VLAN to MAC VLAN; the “no mac-vlan” command cancels the MAC VLAN configuration of this VLAN.

3. Configure the correspondence between the MAC address and the VLAN

Command	Explanation
Global Mode	
mac-vlan mac <mac-addrss> vlan <vlan-id> priority <priority-id> no mac-vlan {mac <mac-addrss> all}	Add/delete the correspondence between the MAC address and the VLAN, namely specified MAC address join/leave specified VLAN.

4. Configure the IP-subnet-based VLAN function on the port

Command	Explanation
Port Mode	
switchport subnet-vlan enable no switchport subnet-vlan enable	Enable/disable the port IP-subnet-base VLAN function on the port.

5. Configure the correspondence between the IP subnet and the VLAN

Command	Explanation
Global Mode	
subnet-vlan ip-address <ipv4-addrss> mask <subnet-mask> vlan <vlan-id> priority <priority-id> no subnet-vlan {ip-address <ipv4-addrss> mask <subnet-mask> all}	Add/delete the correspondence between the IP subnet and the VLAN, namely specified IP subnet joins/leaves specified VLAN.

6. Configure the correspondence between the Protocols and the VLAN

Command	Explanation
Global Mode	
protocol-vlan mode {ethernetii etype <etype-id> llc {dsap <dsap-id> ssap <ssap-id>} snap etype <etype-id>} vlan <vlan-id> priority <priority-id> no protocol-vlan {mode {ethernetii etype <etype-id> llc {dsap <dsap-id> ssap <ssap-id>} snap etype <etype-id>} all}	Add/delete the correspondence between the Protocols and the VLAN, namely specified protocol joins/leaves specified VLAN.

7. Adjust the priority of the dynamic VLAN

Command	Explanation
Global Mode	
dynamic-vlan mac-vlan prefer dynamic-vlan subnet-vlan prefer	Configure the priority of the dynamic VLAN.

14.5.3 Typical Application of the Dynamic VLAN

Scenario:

In the office network Department A belongs to VLAN100. Several members of this department often have the need to move within the whole office network. It is also required to ensure the resource for other members of the department to access VLAN 100. Assume one of the members is M, the MAC address of his PC is 00-30-4f-11-22-33, when M moves to VLAN200 or VLAN300, the port connecting M is configured as Hybrid mode and belongs to VLAN100 with untag mode. In this way, the data of VLAN100 will be forwarded to the port connecting M, and implement the communication requirement in VLAN100.

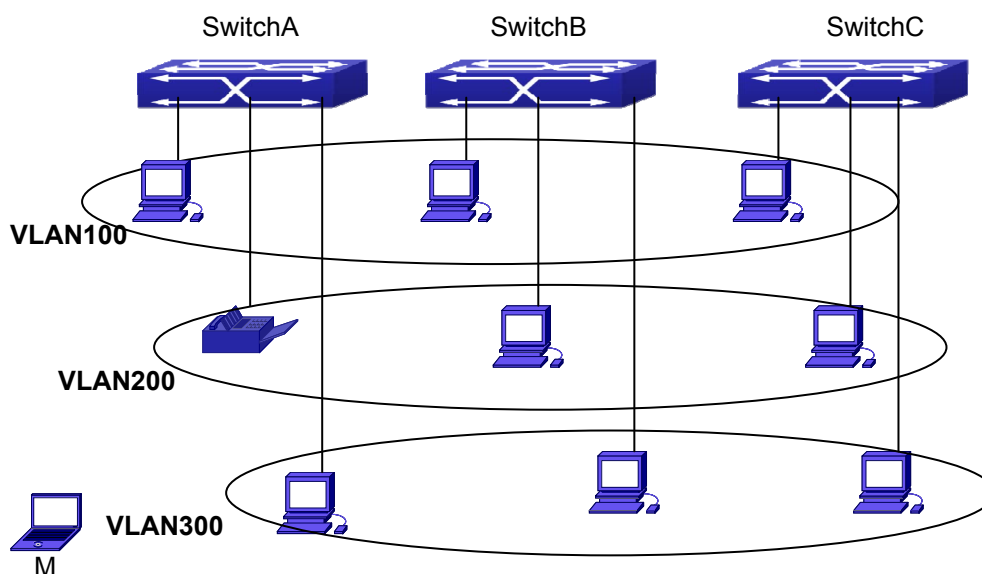

Figure 14-5-1 Typical topology application of dynamic VLAN

Configuration Items	Configuration Explanation
MAC-based VLAN	Global configuration on Switch A, Switch B, Switch C.

For example, M at E1/1 of SwitchA, then the configuration procedures are as follows:

Switch A, Switch B, Switch C:

```
SwitchA (Config)#mac-vlan mac 00-30-4f-11-22-33 vlan 100 priority 0
SwitchA (Config)#interface ethernet 1/1
SwitchA (Config-Ethernet1/1)# swportport mode hybrid
SwitchA (Config-Ethernet1/1)# swportport hybrid allowed vlan 100 untagged

SwitchB (Config)#mac-vlan mac 00-30-4f-11-22-33 vlan 100 priority 0
SwitchB (Config)#exit
```

```
SwitchB#
```

```
SwitchC (Config)#mac-vlan mac 00-30-4f-11-22-33 vlan 100 priority 0
```

```
SwitchC (Config)#exit
```

```
SwitchC#
```

14.5.4 Dynamic VLAN Troubleshooting

- On the switch configured with dynamic VLAN, if the two connected equipment (e.g. PC) are both belongs to the same dynamic VLAN, first communication between the two equipment may not go through. The solution will be letting the two equipment positively send data packet to the XGS3-42000R(such as ping), to let the switch learn their source MAC, then the two equipment will be able to communicate freely within the dynamic VLAN.

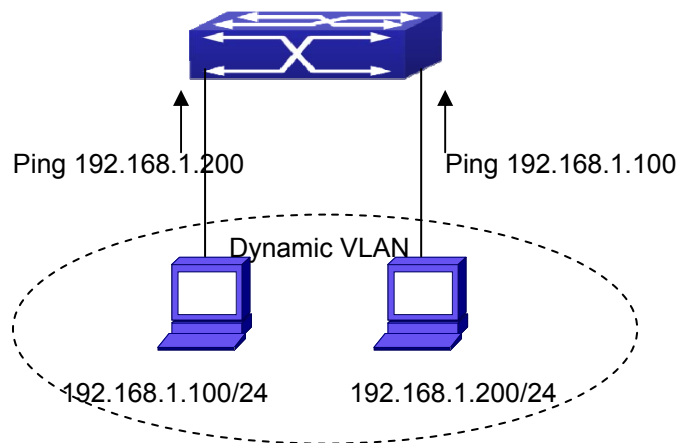

Figure 14-5-2 Dynamic VLAN Troubleshooting

14.6 Voice VLAN Configuration

14.6.1 Introduction to Voice VLAN

Voice VLAN is specially configured for the user voice data traffic. By setting a Voice VLAN and adding the ports of the connected voice equipments to Voice VLAN, the user will be able to configure QoS (Quality of service) service for voice data, and improve voice data traffic transmission priority to ensure the calling quality.

The Chassis Switch can judge if the data traffic is the voice data traffic from specified equipment according to the source MAC address field of the data packet entering the port. The packet with the source MAC address complying with the system defined voice equipment **OUI (Organizational Unique Identifier)** will be considered the voice data traffic and transmitted to the Voice VLAN.

The configuration is based on MAC address, acquiring a mechanism in which every voice equipment transmitting information through the network has got its unique MAC address. VLAN will trace the address belongs to specified MAC. By this means, VLAN allows the voice equipment always belong to Voice VLAN when relocated physically. The greatest advantage of the VLAN is the equipment can be automatically placed into Voice VLAN according to its voice traffic which will be transmitted at specified priority. Meanwhile, when

voice equipment is physically relocated, it still belongs to the Voice VLAN without any further configuration modification, which is because it is based on voice equipment other than switch port.

Notice: Voice VLAN needs to associate with Hybrid attribute of the ports to work, so the ports that may be added to Voice VLAN must be configured as Hybrid port.

14.6.2 Voice VLAN Configuration

Voice VLAN Configuration Task Sequence:

1. Set the VLAN to Voice VLAN
2. Add a voice equipment to Voice VLAN
3. Enable the Voice VLAN on the port

1. Configure the VLAN to Voice VLAN

Command	Explanation
Global Mode	
voice-vlan vlan <vlan-id> no voice-vlan	Set/cancel the VLAN as a Voice VLAN

2. Add a Voice equipment to a Voice VLAN

Command	Explanation
Global Mode	
voice-vlan mac <mac-address> mask <mac-mask> priority <priority-id> [name <voice-name>] no voice-vlan {mac <mac-address> mask <mac-mask> name <voice-name> all}	Specify certain voice equipment join/leave the Voice VLAN

3. Enable the Voice VLAN of the port

Command	Explanation
Port Mode	
switchport voice-vlan enable no switchport voice-vlan enable	Enable/disable the Voice VLAN function on the port

14.6.3 Typical Applications of the Voice VLAN

Scenario:

A company realizes voice communication through configuring Voice VLAN. IP-phone1 and IP-phone2 can be connected to any port of the switch, namely normal communication and interconnected with other switches through the uplink port. IP-phone1 MAC address is 00-30-4f-11-22-33, connect port 1/1 of the switch, IP-phone2 MAC address is 00-30-4f-11-22-55, connect port 1/2 of the switch,.

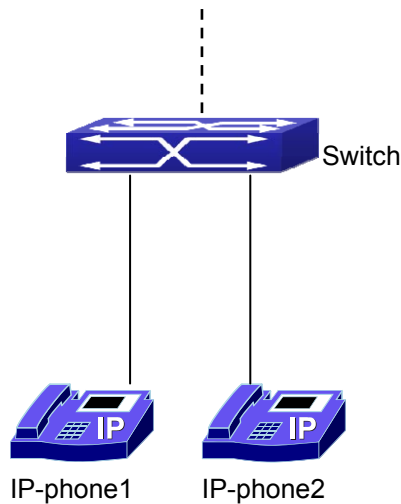

Figure 14-6-1 VLAN typical apply topology

Configuration items	Configuration Explanation
Voice VLAN	Global configuration on the Chassis Switch.

Configuration procedure:

Switch 1:

```
XGS3-42000R(config)#vlan 100
XGS3-42000R(config-Vlan100)#exit
XGS3-42000R(config)#voice-vlan vlan 100
XGS3-42000R(config)#voice-vlan mac 00-30-4f-11-22-33 mask 255 priority 5 name company
XGS3-42000R(config)#voice-vlan mac 00-30-4f-11-22-55 mask 255 priority 5 name company
XGS3-42000R(config)#interface ethernet 1/10
XGS3-42000R(config-If-Ethernet1/10)#switchport mode trunk
XGS3-42000R(config-If-Ethernet1/10)#exit
XGS3-42000R(config)#interface ethernet 1/1
XGS3-42000R(config-If-Ethernet1/1)#switchport mode hybrid
XGS3-42000R(config-If-Ethernet1/1)#switchport hybrid allowed vlan 100 untag
XGS3-42000R(config-If-Ethernet1/1)#exit
XGS3-42000R(config)#interface ethernet 1/2
XGS3-42000R(config-If-Ethernet1/2)#switchport mode hybrid
XGS3-42000R(config-If-Ethernet1/2)#switchport hybrid allowed vlan 100 untag
XGS3-42000R(config-If-Ethernet1/2)#exit
```

14.6.4 Voice VLAN Troubleshooting

- Voice VLAN can not be applied concurrently with MAC-base VLAN
- The Voice VLAN support maximum 1024 sets of voice equipments, the exceeded number of equipments will not be supported
- The Voice VLAN on the port is enabled by default. If the configured data can no longer enter the Voice VLAN during operation, please check if the Voice VLAN function has been disabled on the port.

Chapter 15 MAC Table Configuration

15.1 Introduction to MAC Table

MAC table is a table identifies the mapping relationship between destination MAC addresses and Chassis Switch ports. MAC addresses can be categorized as static MAC addresses and dynamic MAC addresses. Static MAC addresses are manually configured by the user, have the highest priority and are permanently effective (will not be overwritten by dynamic MAC addresses); dynamic MAC addresses are entries learnt by the Chassis Switch in data frame forwarding, and is effective for a limited period. When the switch receives a data frame to be forwarded, it stores the source MAC address of the data frame and creates a mapping to the destination port. Then the MAC table is queried for the destination MAC address, if hit, the data frame is forwarded in the associated port, otherwise, the Chassis Switch forwards the data frame to its broadcast domain. If a dynamic MAC address is not learnt from the data frames to be forwarded for a long time, the entry will be deleted from the switch MAC table.

There are two MAC table operations:

1. Obtain a MAC address.
2. Forward or filter data frame according to the MAC table.

15.1.1 Obtaining MAC Table

The MAC table can be built up statically and dynamically. Static configuration is to set up a mapping between the MAC addresses and the ports; dynamic learning is the process in which the Chassis Switch learns the mapping between MAC addresses and ports, and updates the MAC table regularly. In this section, we will focus on the dynamic learning process of MAC table.

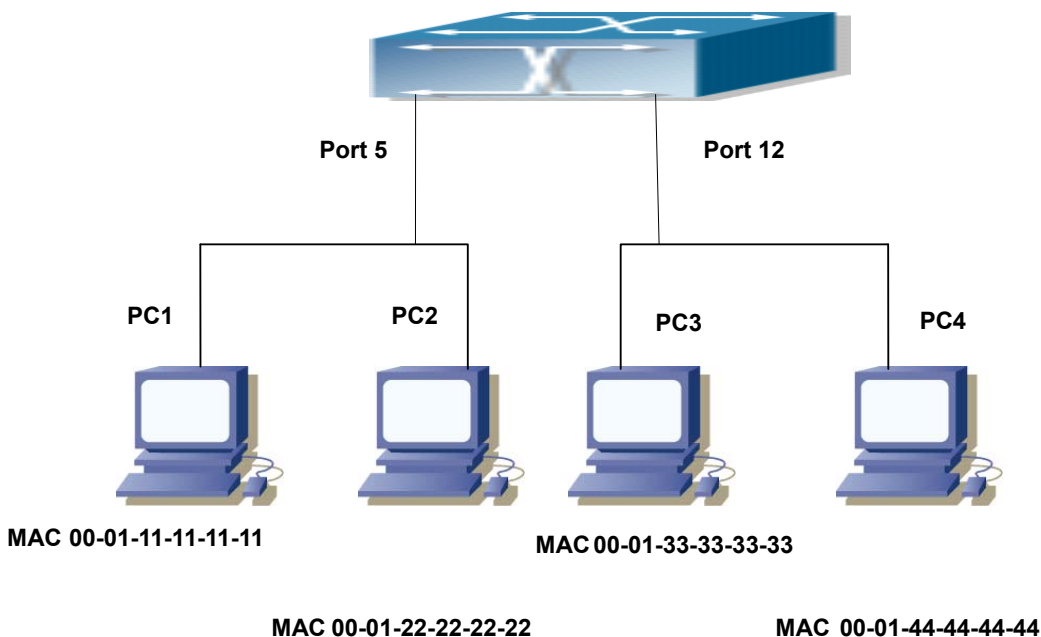

Figure 15-1-1 MAC Table dynamic learning

The topology of the figure above: 4 PCs connected to switch, where PC1 and PC2 belongs to a same physical segment (same collision domain), the physical segment connects to port 1/5 of switch; PC3 and PC4 belongs to the same physical segment that connects to port 1/12 of switch.

The initial MAC table contains no address mapping entries. Take the communication of PC1 and PC3 as an example, the MAC address learning process is as follow:

1. When PC1 sends message to PC3, the switch receives the source MAC address 00-01-11-11-11-11 from this message, the mapping entry of 00-01-11-11-11-11 and port 1/5 is added to the switch MAC table.
2. At the same time, the switch learns the message is destined to 00-01-33-33-33-33, as the MAC table contains only a mapping entry of MAC address 00-01-11-11-11-11 and port1/5, and no port mapping for 00-01-33-33-33-33 present, the switch broadcast this message to all the ports in the XGS3-42000R(assuming all ports belong to the default VLAN1).
3. PC3 and PC4 on port 1/12 receive the message sent by PC1, but PC4 will not reply, as the destination MAC address is 00-01-33-33-33-33, only PC3 will reply to PC1. When port 1/12 receives the message sent by PC3, a mapping entry for MAC address 00-01-33-33-33-33 and port 1/12 is added to the MAC table.
4. Now the MAC table has two dynamic entries, MAC address 00-01-11-11-11-11 - port 1/5 and 00-01-33-33-33-33 -port1/12.
5. After the communication between PC1 and PC3, the switch does not receive any message sent from PC1 and PC3. And the MAC address mapping entries in the MAC table are deleted after 300 seconds. The 300 seconds here is the default aging time for MAC address entry in switch. Aging time can be modified in switch.

15.1.2 Forward or Filter

The Chassis Switch will forward or filter received data frames according to the MAC table. Take the above figure as an example, assuming Chassis Switch have learnt the MAC address of PC1 and PC3, and the user manually configured the mapping relationship for PC2 and PC4 to ports. The MAC table of Chassis Switch will be:

MAC Address	Port number	Entry added by
00-01-11-11-11-11	1/5	Dynamic learning
00-01-22-22-22-22	1/5	Static configuration
00-01-33-33-33-33	1/12	Dynamic learning
00-01-44-44-44-44	1/12	Static configuration

1. Forward data according to the MAC table
If PC1 sends a message to PC3, the Chassis Switch will forward the data received on port 1/5 from port1/12.
2. Filter data according to the MAC table
If PC1 sends a message to PC2, the Chassis Switch, on checking the MAC table, will find PC2 and PC1 are in the same physical segment and filter the message (i.e. drop this message).

Three types of frames can be forwarded by the Chassis Switch:

- Broadcast frame
- Multicast frame
- Unicast frame

The following describes how the Chassis Switch deals with all the three types of frames:

- Broadcast frame: The switch can segregate collision domains but not broadcast domains. If no VLAN is set, all devices connected to the Chassis Switch are in the same broadcast domain. When the Chassis Switch receives a broadcast frame, it forwards the frame in all ports. When VLANs are configured in the Chassis Switch, the MAC table will be adapted accordingly to add VLAN information. In this case, the Chassis Switch will not forward the received broadcast frames in all ports, but forward the frames in all ports in the same VLAN.
- Multicast frame: When IGMP Snooping function is not enabled, multicast frames are processed in the same way as broadcast frames; when IGMP Snooping is enabled, the Chassis Switch will only forward the multicast frames to the ports belonging to the very multicast group.
- Unicast frame: When no VLAN is configured, if the destination MAC addresses are in the Chassis Switch MAC table, the Chassis Switch will directly forward the frames to the associated ports; when the destination MAC address in a unicast frame is not found in the MAC table, the Chassis Switch will broadcast the unicast frame. When VLANs are configured, the switch will forward unicast frame within the same VLAN. If the destination MAC address is found in the MAC table but belonging to different VLANs, the Chassis Switch can only broadcast the unicast frame in the VLAN it belongs to.

15.2 Mac Address Table Configuration Task List

1. Configure the MAC address aging-time
2. Configure static MAC forwarding or filter entry

1. Configure the MAC aging-time

Command	Explanation
Global Mode	
mac-address-table aging-time <0/aging-time> no mac-address-table aging-time	Configure the MAC address aging-time.

2. Configure static MAC forwarding or filter entry

Command	Explanation
Global Mode	
mac-address-table {static blackhole} address <mac-addr> vlan <vlan-id > [interface [ethernet portchannel] <interface-name>] [source destination both] no mac-address-table {static blackhole dynamic} [address <mac-addr>] [vlan	Configure static MAC forwarding or filter entry.

```
<vlan-id> [interface [ethernet |  
portchannel] <interface-name>]
```

15.3 Typical Configuration Examples

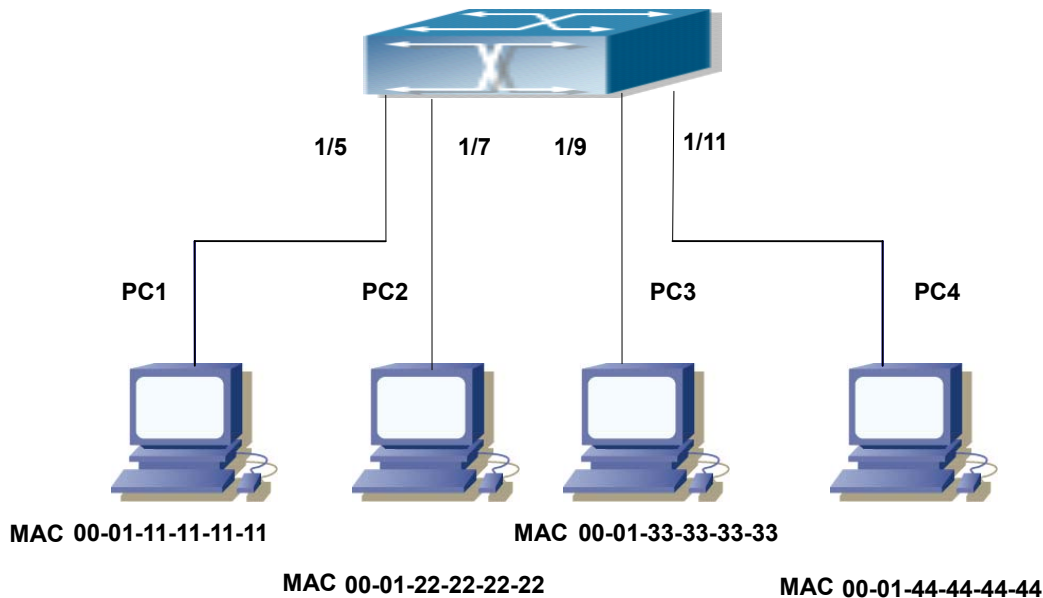

Figure 15-3-1 MAC Table typical configuration example

Scenario:

Four PCs as shown in the above figure connect to port 1/5、1/7、1/9、1/11 of Chassis Switch, all the four PCs belong to the default VLAN1. As required by the network environment, dynamic learning is enabled. PC1 holds sensitive data and can not be accessed by any other PC that is in another physical segment; PC2 and PC3 have static mapping set to port 7 and port 9, respectively.

The configuration steps are listed below:

1. Set the MAC address 00-01-11-11-11-11 of PC1 as a filter address.

```
XGS3-42000R(config)#mac-address-table static 00-01-11-11-11-11 discard vlan 1.
```

2. Set the static mapping relationship for PC2 and PC3 to port 7 and port 9, respectively.

```
XGS3-42000R(config)#mac-address-table static 00-01-22-22-22-22 interface ethernet 1/7 vlan 1  
XGS3-42000R(config)#mac-address-table static 00-01-33-33-33-33 interface ethernet 1/9 vlan 1
```

15.4 MAC Table Troubleshooting

Using the show mac-address-table command, a port is found to be failed to learn the MAC of a device connected to it. Possible reasons:

- The connected cable is broken.

- Spanning Tree is enabled and the port is in “discarding” status; or the device is just connected to the port and Spanning Tree is still under calculation, wait until the Spanning Tree calculation finishes, and the port will learn the MAC address.
- If not the problems mentioned above , please check for the Chassis Switch port and contact technical support for solution.

15.5 MAC Address Function Extension

15.5.1 MAC Address Binding

15.5.1.1 Introduction to MAC Address Binding

Most switches support MAC address learning, each port can dynamically learn several MAC addresses, so that forwarding data streams between known MAC addresses within the ports can be achieved. If a MAC address is aged, the packet destined for that entry will be broadcasted. In other words, a MAC address learned in a port will be used for forwarding in that port, if the connection is changed to another port, the switch will learn the MAC address again to forward data in the new port.

However, in some cases, security or management policy may require MAC addresses to be bound with the ports, only data stream from the binding MAC are allowed to be forwarded in the ports. That is to say, after a MAC address is bound to a port, only the data stream destined for that MAC address can flow in from the binding port, data stream destined for the other MAC addresses that not bound to the port will not be allowed to pass through the port.

15.5.1.2 MAC Address Binding Configuration Task List

1. Enable MAC address binding function for the ports
2. Lock the MAC addresses for a port
3. MAC address binding property configuration

1. Enable MAC address binding function for the ports

Command	Explanation
Port Mode	
switchport port-security no switchport port-security	Enable MAC address binding function for the port and lock the port. When a port is locked, the MAC address learning function for the port will be disabled: the “ no switchport port-security ” command disables the MAC address binding function for the port, and restores the MAC address learning function for the port.

2. Lock the MAC addresses for a port

Command	Explanation
Port Mode	
switchport port-security lock no switchport port-security lock	Lock the port, then MAC addresses learned will be disabled. The “ no switchport port-security lock ” command restores the function.
switchport port-security convert	Convert dynamic secure MAC addresses learned by the port to static secure MAC addresses.
switchport port-security timeout <value> no switchport port-security timeout	Enable port locking timer function; the “ no switchport port-security timeout ” restores the default setting.
switchport port-security mac-address <mac-address> no switchport port-security mac-address <mac-address>	Add static secure MAC address; the “ no switchport port-security mac-address ” command deletes static secure MAC address.
Admin Mode	
clear port-security dynamic [address <mac-addr> interface <interface-id>]	Clear dynamic MAC addresses learned by the specified port.

3. MAC address binding property configuration

Command	Explanation
Port Mode	
switchport port-security maximum <value> no switchport port-security maximum <value>	Set the maximum number of secure MAC addresses for a port; the “ no switchport port-security maximum ” command restores the default value.
switchport port-security violation {protect shutdown} no switchport port-security violation	Set the violation mode for the port; the “ no switchport port-security violation ” command restores the default setting.

15.5.1.3 Binding MAC Address Binding Troubleshooting

Enabling MAC address binding for ports may fail in some occasions. Here are some possible causes and solutions:

Chapter 16 MSTP Configuration

16.1 Introduction to MSTP

The MSTP (Multiple STP) is a new spanning-tree protocol which is based on the STP and the RSTP. It runs on all the bridges of a bridged-LAN. It calculates a common and internal spanning tree (CIST) for the bridge-LAN which consists of the bridges running the MSTP, the RSTP and the STP. It also calculates the independent multiple spanning-tree instances (MSTI) for each MST domain (MSTP domain). The MSTP, which adopts the RSTP for its rapid convergence of the spanning tree, enables multiple VLANs to be mapped to the same spanning-tree instance which is independent to other spanning-tree instances. The MSTP provides multiple forwarding paths for data traffic and enables load balancing. Moreover, because multiple VLANs share a same MSTI, the MSTP can reduce the number of spanning-tree instances, which consumes less CPU resources and reduces the bandwidth consumption.

16.1.1 MSTP Region

Because multiple VLANs can be mapped to a single spanning tree instance, IEEE 802.1s committee raises the MST concept. The MST is used to make the association of a certain VLAN to a certain spanning tree instance.

A MSTP region is composed of one or multiple bridges with the same MCID (MST Configuration Identification) and the bridged-LAN (a certain bridge in the MSTP region is the designated bridge of the LAN, and the bridges attaching to the LAN are not running STP). All the bridges in the same MSTP region have the same MSID.

MSID consists of 3 attributes:

- Configuration Name: Composed by digits and letters
- Revision Level
- Configuration Digest: VLANs mapping to spanning tree instances

The bridges with the same 3 above attributes are considered as in the same MST region.

When the MSTP calculates CIST in a bridged-LAN, a MSTP region is considered as a bridge. See the figure below:

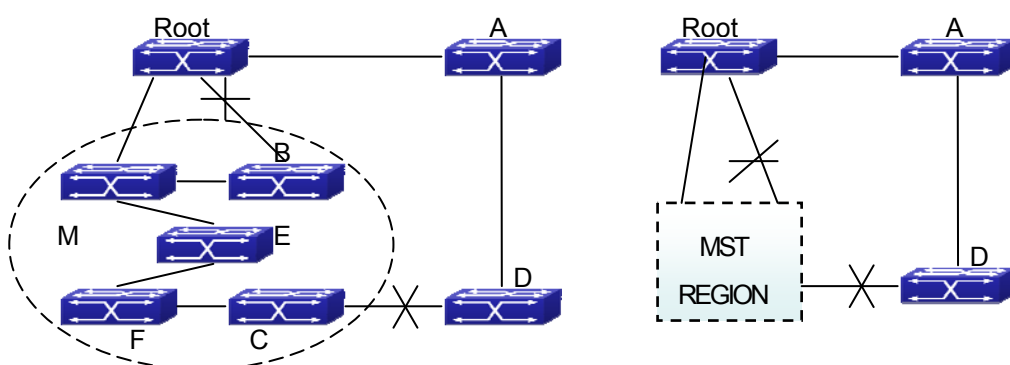

Figure 16-1-1 Example of CIST and MST Region

In the above network, if the bridges are running the STP or the RSTP, one port between Bridge M and Bridge B should be blocked. But if the bridges in the yellow range run the MSTP and are configured in the same MST region, MSTP will treat this region as a bridge. Therefore, one port between Bridge B and Root is blocked and one port on Bridge D is blocked.

16.1.1.1 Operations within an MSTP Region

The IST connects all the MSTP bridges in a region. When the IST converges, the root of the IST becomes the IST master, which is the switch within the region with the lowest bridge ID and path cost to the CST root. The IST master is also the CST root if there is only one region within the network. If the CST root is outside the region, one of the MSTP bridges at the boundary of the region is selected as the IST master.

When an MSTP bridge initializes, it sends BPDUs claiming itself as the root of the CST and the IST master, with both of the path costs to the CST root and to the IST master set to zero. The bridge also initializes all of its MST instances and claims to be the root for all of them. If the bridge receives superior MST root information (lower bridge ID, lower path cost, and so forth) than currently stored for the port, it relinquishes its claim as the IST master. Within a MST region, the IST is the only spanning-tree instance that sends and receives BPDUs. Because the MST BPDU carries information for all instances, the number of BPDUs that need to be processed by a switch to support multiple spanning-tree instances is significantly reduced.

All MST instances within the same region share the same protocol timers, but each MST instance has its own topology parameters, such as root switch ID, root path cost, and so forth.

16.1.1.2 Operations between MST Regions

If there are multiple regions or legacy 802.1D bridges within the network, MSTP establishes and maintains the CST, which includes all MST regions and all legacy STP bridges in the network. The MST instances combine with the IST at the boundary of the region to become the CST.

The MSTI is only valid within its MST region. An MSTI has nothing to do with MSTIs in other MST regions. The bridges in an MST region receive the MST BPDU of other regions through Boundary Ports. They only process CIST-related information and abandon MSTI information.

16.1.2 Port Roles

The MSTP bridge assigns a port role to each port which runs MSTP.

- CIST port roles: Root Port, Designated Port, Alternate Port and Backup Port
- On top of those roles, each MSTI port has one new role: Master Port.

The port roles in the CIST (Root Port, Designated Port, Alternate Port and Backup Port) are defined in the same way as those in the RSTP.

16.1.3 MSTP Load Balance

In a MSTP region, VLANs can be mapped to various instances. That can form various topologies. Each instance is independent from the others and each instance can have its own attributes such as bridge priority and port cost etc. Consequently, the VLANs in different instances have their own paths. The traffic of the VLANs are load-balanced.

16.2 MSTP Configuration Task List

MSTP configuration task list:

1. Enable the MSTP and set the running mode
2. Configure instance parameters
3. Configure MSTP region parameters
4. Configure MSTP time parameters
5. Configure the fast migrate feature for MSTP
6. Configure the format of port packet
7. Configure the snooping attribute of authentication key
8. Configure the FLUSH mode once topology changes

1. Enable MSTP and set the running mode

Command	Explanation
Global Mode and Port Mode	
spanning-tree no spanning-tree	Enable/Disable MSTP.
Global Mode	
spanning-tree mode {mstp stp rstp} no spanning-tree mode	Set MSTP running mode.
Port Mode	
spanning-tree mcheck	Force port migrate to run under MSTP.

2. Configure instance parameters

Command	Explanation
Global Mode	
spanning-tree mst <instance-id> priority <bridge-priority> no spanning-tree mst <instance-id> priority	Set bridge priority for specified instance.
spanning-tree priority <bridge-priority> no spanning-tree priority	Configure the spanning-tree priority of the switch.
Port Mode	
spanning-tree mst <instance-id> cost <cost> no spanning-tree mst <instance-id> cost	Set port path cost for specified instance.
spanning-tree mst <instance-id> port-priority <port-priority> no spanning-tree mst <instance-id> port-priority	Set port priority for specified instance.
spanning-tree mst <instance-id> rootguard no spanning-tree mst <instance-id> rootguard	Configure currently port whether running rootguard in specified instance, configure the rootguard port can't turn to root port.
spanning-tree rootguard no spanning-tree rootguard	Configure currently port whether running rootguard in instance 0, configure the rootguard port can't turn to root port.

3. Configure MSTP region parameters

Command	Explanation
Global Mode	
spanning-tree mst configuration no spanning-tree mst configuration	Enter MSTP region mode. The no command restores the default setting.
MSTP region mode	
instance <instance-id> vlan <vlan-list> no instance <instance-id> [vlan <vlan-list>]	Create Instance and set mapping between VLAN and Instance.
name <name> no name	Set MSTP region name.
revision-level <level> no revision-level	Set MSTP region revision level.
abort	Quit MSTP region mode and return to Global mode without saving MSTP region configuration.
exit	Quit MSTP region mode and return to Global mode with saving MSTP region configuration.

4. Configure MSTP time parameters

Command	Explanation
Global Mode	
spanning-tree forward-time <time> no spanning-tree forward-time	Set the value for switch forward delay time.
spanning-tree hello-time <time> no spanning-tree hello-time	Set the Hello time for sending BPDU messages.
spanning-tree maxage <time> no spanning-tree maxage	Set Aging time for BPDU messages.
spanning-tree max-hop <hop-count> no spanning-tree max-hop	Set Maximum number of hops of BPDU messages in the MSTP region.

5. Configure the fast migrate feature for MSTP

Command	Explanation
Port Mode	
spanning-tree link-type p2p {auto force-true force-false} no spanning-tree link-type	Set the port link type.
spanning-tree portfast [bpdufilter] bpduguard] no spanning-tree portfast	Set and cancel the port to be an boundary port. bpdufilter receives the BPDU discarding; bpduguard receives the BPDU will disable port; no parameter receives the BPDU, the port becomes a non-boundary port.

6. Configure the format of MSTP

Command	Explanation
Port Mode	
spanning-tree format standard spanning-tree format privacy spanning-tree format auto no spanning-tree format	Configure the format of port spanning-tree packet, standard format is provided by IEEE, privacy is compatible with CISCO and auto means the format is determined by checking the received packet.

7. Configure the snooping attribute of authentication key

Command	Explanation
Port Mode	
spanning-tree digest-snooping no spanning-tree digest-snooping	Set the port to use the authentication string of partner port. The no restores to use the generated string.

8. Configure the FLUSH mode once topology changes

Command	Explanation
Global Mode	
spanning-tree tflush {enable disable protect} no spanning-tree tflush	Enable: the spanning-tree flush once the topology changes. Disable: the spanning tree don't flush when the topology changes. Protect: the spanning-tree flush not more than one time every ten seconds. The no command restores to default setting, enable flush once the topology changes.
Port Mode	
spanning-tree tflush {enable disable protect} no spanning-tree tflush	Configure the port flush mode. The no command restores to use the global configured flush mode.

16.3 MSTP Example

The following is a typical MSTP application example:

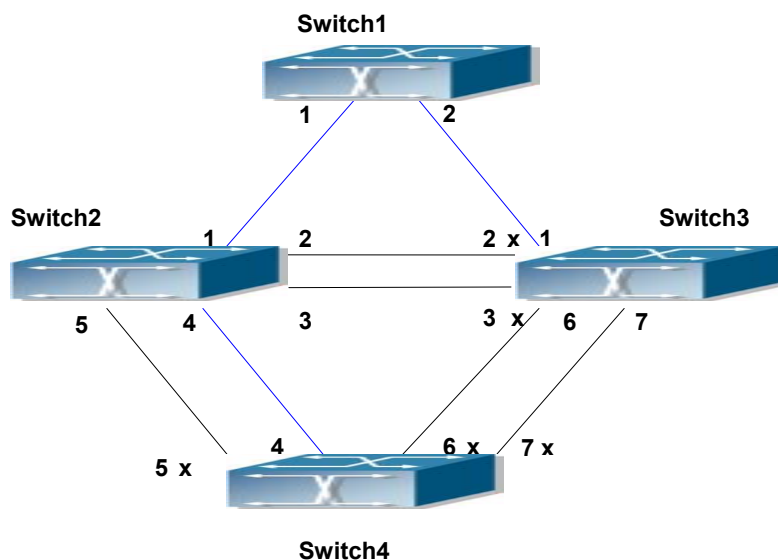

Figure 16-3-1 Typical MSTP Application Scenario

The connections among the switches are shown in the above figure. All the switches run in the MSTP mode by default, their bridge priority, port priority and port route cost are all in the default values (equal). The default configuration for switches is listed below:

Bridge Name		Switch1	Switch2	Switch3	Switch4
Bridge MAC Address		...00-00-01	...00-00-02	...00-00-03	...00-00-04
Bridge Priority		32768	32768	32768	32768
Port Priority	Port 1	128	128	128	
	Port 2	128	128	128	
	Port 3		128	128	
	Port 4		128		128
	Port 5		128		128
	Port 6			128	128
	Port 7			128	128
Route Cost	Port 1	200000	200000	200000	
	Port 2	200000	200000	200000	
	Port 3		200000	200000	
	Port 4		200000		200000
	Port 5		200000		200000
	Port 6			200000	200000
	Port 7			200000	200000

By default, the MSTP establishes a tree topology (in blue lines) rooted with SwitchA. The ports marked with “x” are in the discarding status, and the other ports are in the forwarding status.

Configurations Steps:

Step 1: Configure port to VLAN mapping:

- Create VLAN 20, 30, 40, 50 in Switch2, Switch3 and Switch4.
- Set ports 1-7 as trunk ports in Switch2 Switch3 and Switch4.

Step 2: Set Switch2, Switch3 and Switch4 in the same MSTP:

- Set Switch2, Switch3 and Switch4 to have the same region name as mstp.
- Map VLAN 20 and VLAN 30 in Switch2, Switch3 and Switch4 to Instance 3; Map VLAN 40 and VLAN 50 in Switch2, Switch3 and Switch4 to Instance 4.

Step 3: Set Switch3 as the root bridge of Instance 3; Set Switch4 as the root bridge of Instance 4

- Set the bridge priority of Instance 3 in Switch3 as 0.
- Set the bridge priority of Instance 4 in Switch4 as 0.

The detailed configuration is listed below:

Switch2:

```
Switch2(config)#vlan 20
Switch2(Config-Vlan20)#exit
Switch2(config)#vlan 30
Switch2(Config-Vlan30)#exit
Switch2(config)#vlan 40
Switch2(Config-Vlan40)#exit
Switch2(config)#vlan 50
Switch2(Config-Vlan50)#exit
```

```
Switch2(config)#spanning-tree mst configuration
Switch2(Config-Mstp-Region)#name mstp
Switch2(Config-Mstp-Region)#instance 3 vlan 20;30
Switch2(Config-Mstp-Region)#instance 4 vlan 40;50
Switch2(Config-Mstp-Region)#exit
Switch2(config)#interface e1/1-7
Switch2(Config-Port-Range)#switchport mode trunk
Switch2(Config-Port-Range)#exit
Switch2(config)#spanning-tree
```

Switch3:

```
Switch3(config)#vlan 20
Switch3(Config-Vlan20)#exit
Switch3(config)#vlan 30
Switch3(Config-Vlan30)#exit
Switch3(config)#vlan 40
Switch3(Config-Vlan40)#exit
Switch3(config)#vlan 50
Switch3(Config-Vlan50)#exit
Switch3(config)#spanning-tree mst configuration
Switch3(Config-Mstp-Region)#name mstp
Switch3(Config-Mstp-Region)#instance 3 vlan 20;30
Switch3(Config-Mstp-Region)#instance 4 vlan 40;50
Switch3(Config-Mstp-Region)#exit
Switch3(config)#interface e1/1-7
Switch3(Config-Port-Range)#switchport mode trunk
Switch3(Config-Port-Range)#exit
Switch3(config)#spanning-tree
Switch3(config)#spanning-tree mst 3 priority 0
```

Switch4:

```
Switch4(config)#vlan 20
Switch4(Config-Vlan20)#exit
Switch4(config)#vlan 30
Switch4(Config-Vlan30)#exit
Switch4(config)#vlan 40
Switch4(Config-Vlan40)#exit
Switch4(config)#vlan 50
Switch4(Config-Vlan50)#exit
Switch4(config)#spanning-tree mst configuration
Switch4(Config-Mstp-Region)#name mstp
Switch4(Config-Mstp-Region)#instance 3 vlan 20;30
Switch4(Config-Mstp-Region)#instance 4 vlan 40;50
Switch4(Config-Mstp-Region)#exit
Switch4(config)#interface e1/1-7
```

```

Switch4(Config-Port-Range)#switchport mode trunk
Switch4(Config-Port-Range)#exit
Switch4(config)#spanning-tree
Switch4(config)#spanning-tree mst 4 priority 0

```

After the above configuration, Switch1 is the root bridge of the instance 0 of the entire network. In the MSTP region which Switch2, Switch3 and Switch4 belong to, Switch2 is the region root of the instance 0, Switch3 is the region root of the instance 3 and Switch4 is the region root of the instance 4. The traffic of VLAN 20 and VLAN 30 is sent through the topology of the instance 3. The traffic of VLAN 40 and VLAN 50 is sent through the topology of the instance 4. And the traffic of other VLANs is sent through the topology of the instance 0. The port 1 in Switch2 is the master port of the instance 3 and the instance 4.

The MSTP calculation generates 3 topologies: the instance 0, the instance 3 and the instance 4 (marked with blue lines). The ports with the mark "x" are in the status of discarding. The other ports are the status of forwarding. Because the instance 3 and the instance 4 are only valid in the MSTP region, the following figure only shows the topology of the MSTP region.

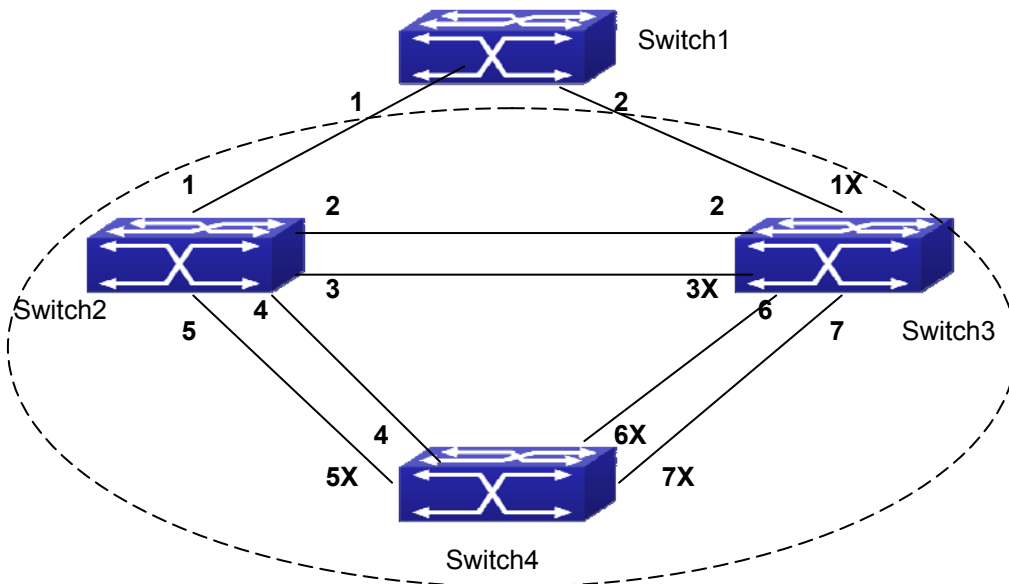

Figure 16-3-2 The Topology Of the Instance 0 after the MSTP Calculation

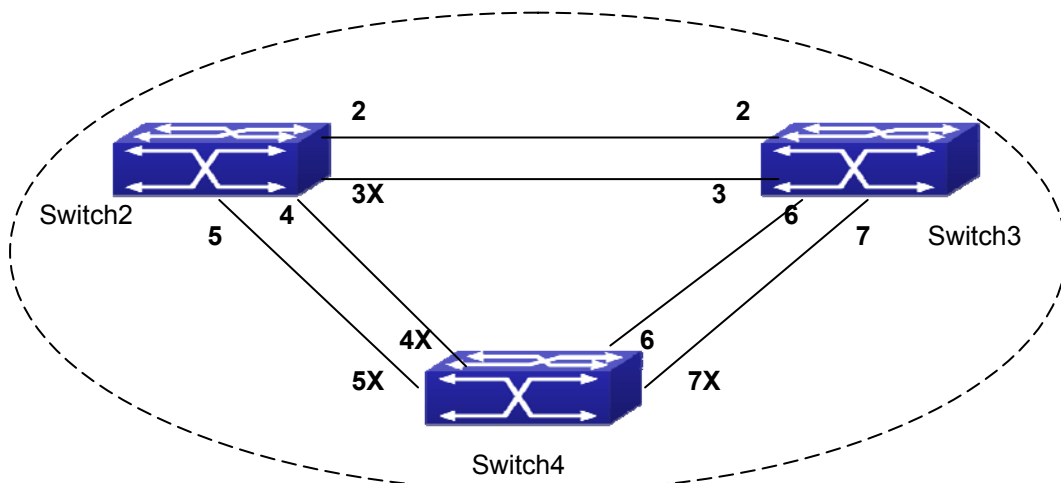

Figure 16-3-3 The Topology Of the Instance 3 after the MSTP Calculation

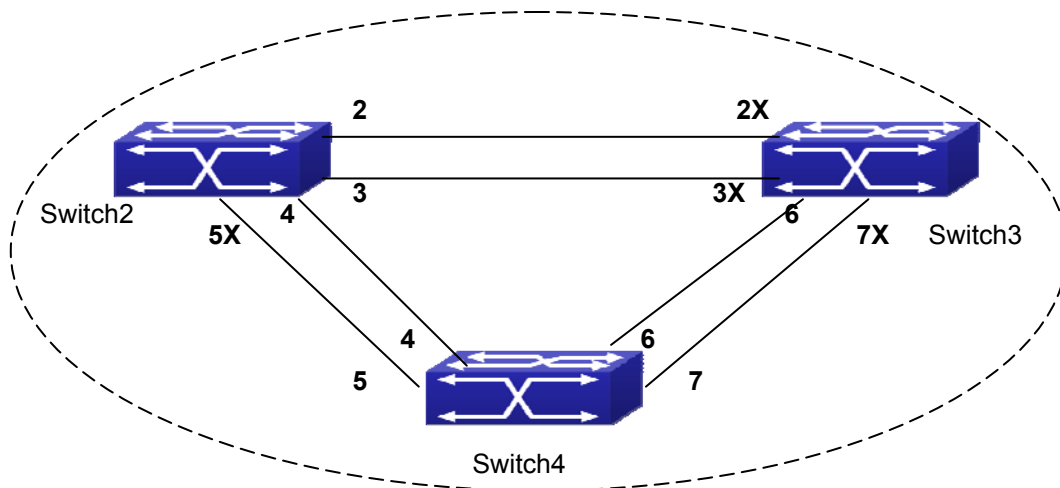

Figure 16-3-4 The Topology Of the Instance 4 after the MSTP Calculation

16.4 MSTP Troubleshooting

- In order to run the MSTP on the switch port, the MSTP has to be enabled globally. If the MSTP is not enabled globally, it can't be enabled on the port.
- The MSTP parameters co-work with each other, so the parameters should meet the following conditions. Otherwise, the MSTP may work incorrectly.
 - $2 \times (\text{Bridge_Forward_Delay} - 1.0 \text{ seconds}) \geq \text{Bridge_Max_Age}$
 - $\text{Bridge_Max_Age} \geq 2 \times (\text{Bridge_Hello_Time} + 1.0 \text{ seconds})$
- When users modify the MSTP parameters, they have to be sure about the changes of the topologies. The global configuration is based on the bridge. Other configurations are based on the individual instances.

Chapter 17 QoS Configuration

17.1 Introduction to QoS

QoS (Quality of Service) is a set of capabilities that allow you to create differentiated services for network traffic, thereby providing better service for selected network traffic. QoS is a guarantee for service quality of consistent and predictable data transfer service to fulfill program requirements. QoS cannot generate extra bandwidth but provides more effective bandwidth management according to the application requirement and network management policy.

17.1.1 QoS Terms

CoS: Class of Service, the classification information carried by Layer 2 802.1Q frames, taking 3 bits of the Tag field in frame header, is called user priority level in the range of 0 to 7.

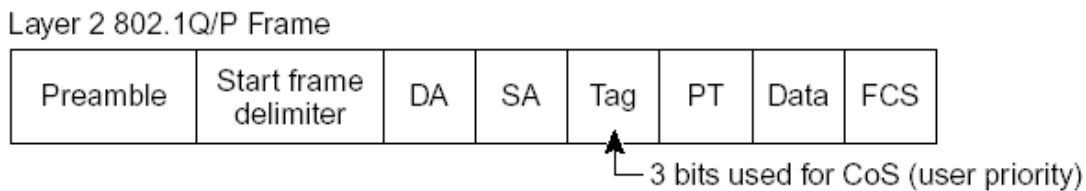

Figure 17-1-1 CoS priority

ToS: Type of Service, a one-byte field carried in Layer 3 IPv4 packet header to symbolize the service type of IP packets. Among them, ToS field can be IP Precedence value or DSCP value.

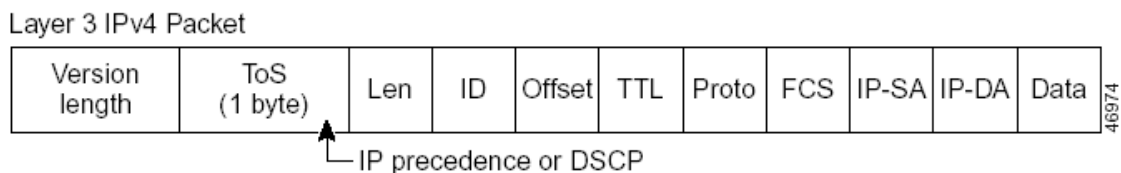

Figure 17-1-2 ToS priority

IP Precedence: IP priority. Classification information carried in Layer 3 IP packet header, occupying 3 bits, in the range of 0 to 7.

DSCP: Differentiated Services Code Point, classification information carried in Layer 3 IP packet header, occupying 6 bits, in the range of 0 to 63, and is downward compatible with IP Precedence.

DSCP-inside: The switch-inside priority configuration, be used to partition priority for the switch-inside data, range from 0 to 63.

Classification: The entry action of QoS, classifying packet traffic according to the classification information carried in the packet and ACLs.

Policing: Ingress action of QoS that lays down the policing policy and manages the classified packets.

Remark: Ingress action of QoS, perform allowing, degrading or discarding operations to packets according to the policing policies.

Queuing: Egress QoS action. Put the packets to appropriate egress queues according to the packet CoS value.

Scheduling: QoS egress action. Configure the weight for eight egress queues WRR (Weighted Round Robin).

In-Profile: Traffic within the QoS policing policy range (bandwidth or burst value) is called "In-Profile".

Out-of-Profile: Traffic out the QoS policing policy range (bandwidth or burst value) is called "Out-of-Profile".

17.1.2 QoS Implementation

To implement the Chassis Switch software QoS, a general, mature reference model should be given. QoS can not create new bandwidth, but can maximize the adjustment and configuration for the current bandwidth resource. Fully implemented QoS can achieve complete management over the network traffic. The following is as accurate as possible a description of QoS.

The data transfer specifications of IP cover only addresses and services of source and destination, and ensure correct packet transmission using OSI layer 4 or above protocols such as TCP. However, rather than provide a mechanism for providing and protecting packet transmission bandwidth, IP provide bandwidth service by the best effort. This is acceptable for services like Mail and FTP, but for increasing multimedia business data and e-business data transmission, this best effort method cannot satisfy the bandwidth and low-lag requirement.

Based on differentiated service, QoS specifies a priority for each packet at the ingress. The classification information is carried in Layer 3 IP packet header or Layer 2 802.1Q frame header. QoS provides same service to packets of the same priority, while offers different operations for packets of different priority. QoS-enabled switch or router can provide different bandwidth according to the packet classification information, and can remark on the classification information according to the policing policies configured, and may discard some low priority packets in case of bandwidth shortage.

If devices of each hop in a network support differentiated service, an end-to-end QoS solution can be created. QoS configuration is flexible, the complexity or simplicity depends on the network topology and devices and analysis to incoming/outgoing traffic.

17.1.3 Basic QoS Model

The basic QoS consists of five parts: Classification, Policing, Remarks, Queuing and Scheduling, where classification, policing and remark are sequential ingress actions, and Queuing and Scheduling are QoS egress actions.

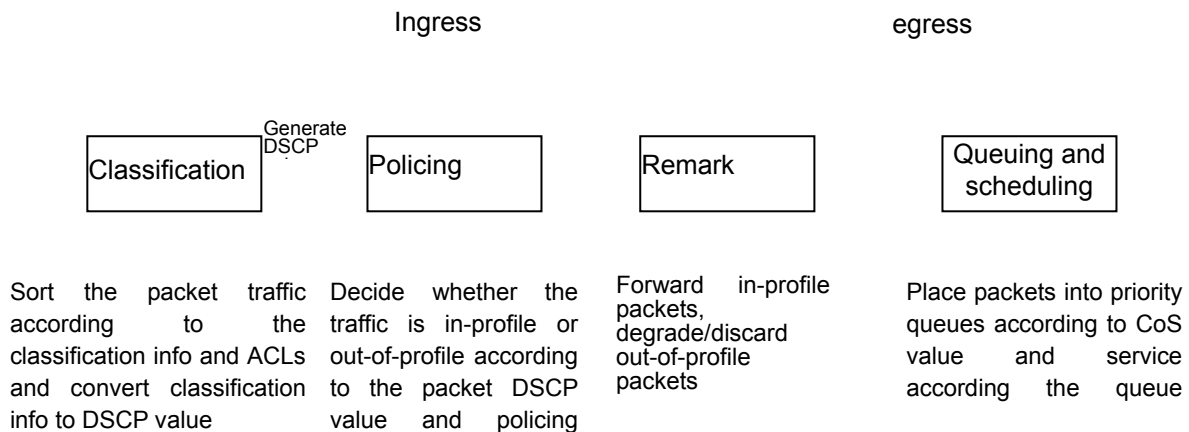

Figure 17-1-3 Basic QoS Model

Classification: Classify traffic according to packet classification information and generate internal DSCP value based on the classification information. For different packet types and switch configurations, classification is performed differently; the flowchart below explains this in details.

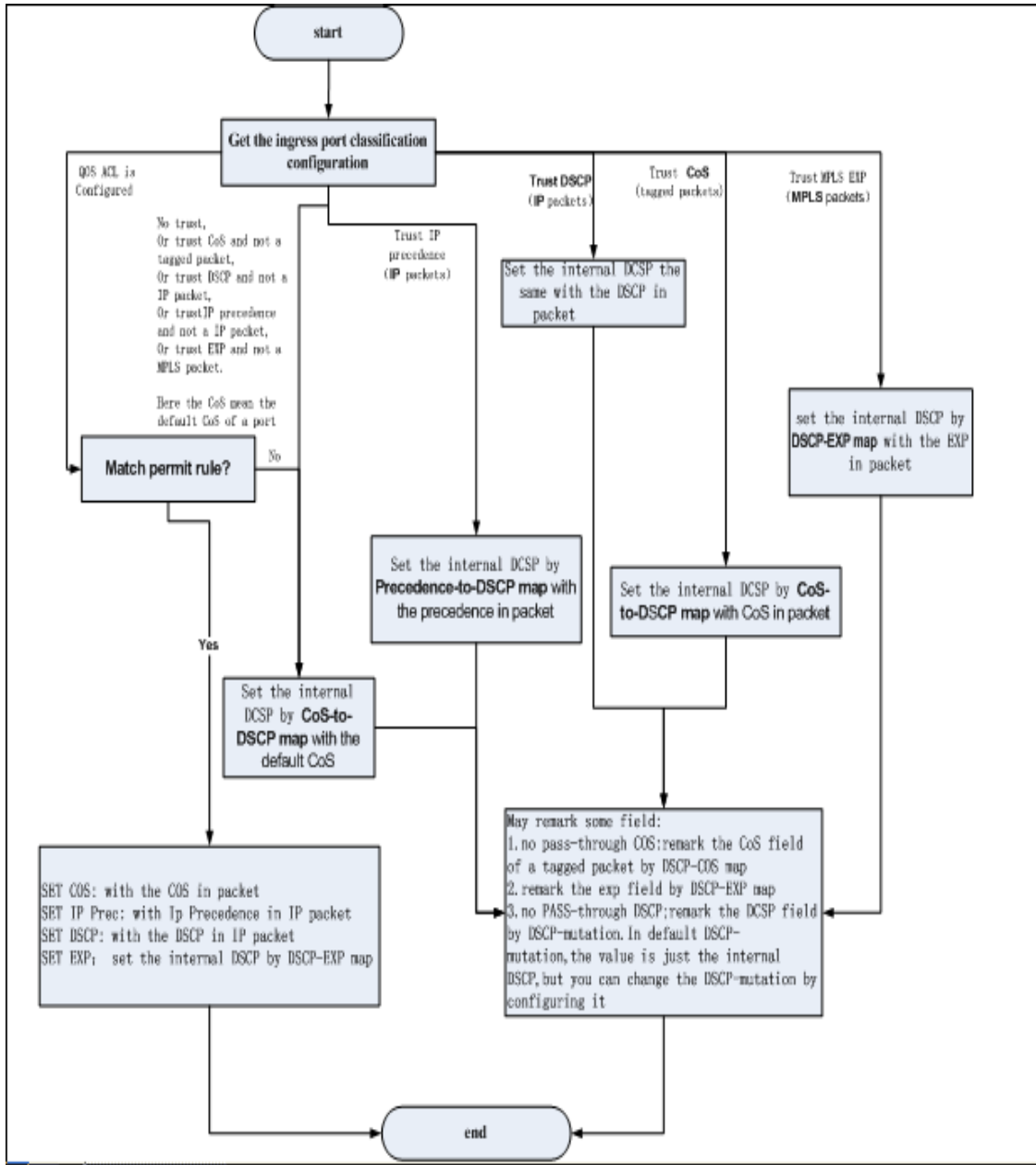

Figure 17-1-4 Classification process

Policing and remark: Each packet in classified ingress traffic is assigned an internal DSCP value and can be policed and remarked. Policing can be performed based on DSCP value to configure different policies that allocate bandwidth to classified traffic. If the traffic exceeds the bandwidth set in the policy (out-of-profile), the out of profile traffic can be allowed, discarded or remarked. Remarking uses a new DSCP value of lower priority to replace the original higher level DSCP value in the packet; this is also called Marking Down. The following flowchart describes the operations during policing and remarking.

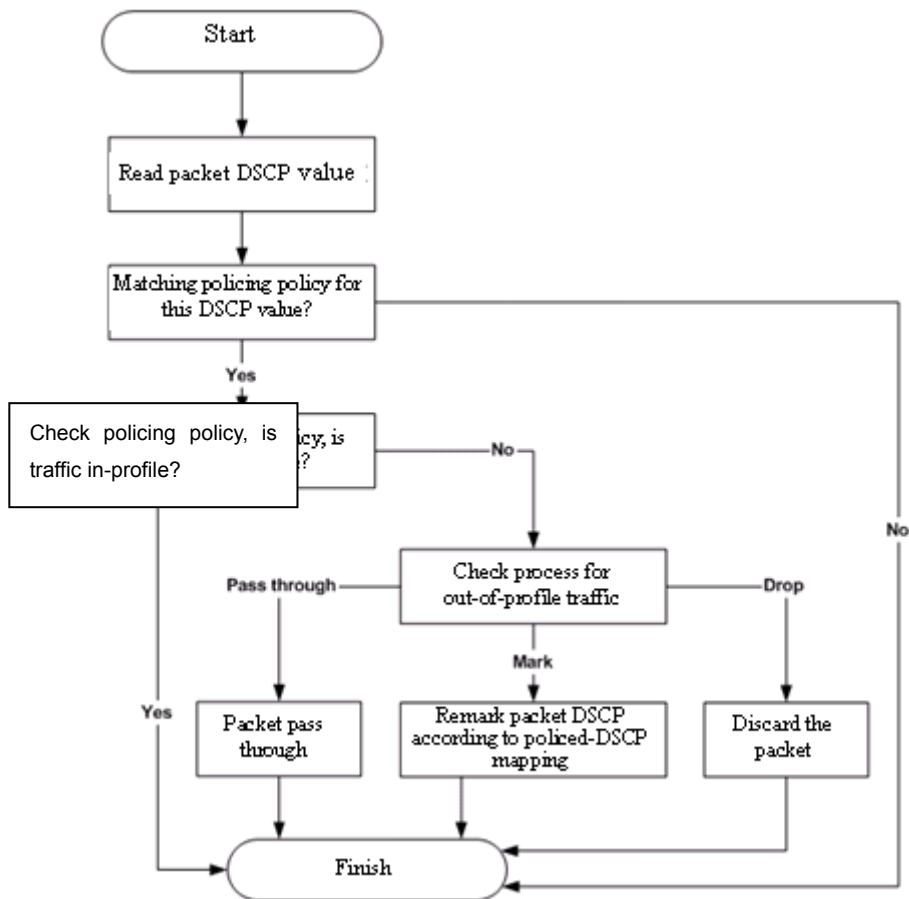

Figure 17-1-5 Policing and Remarking process

Queuing and scheduling: Packets at the egress will re-map the internal DSCP value to CoS value, the queuing operation assigns packets to appropriate queues of priority according to the CoS value; while the scheduling operation performs packet forwarding according to the prioritized queue weight. The following flowchart describes the operations during queuing and scheduling.

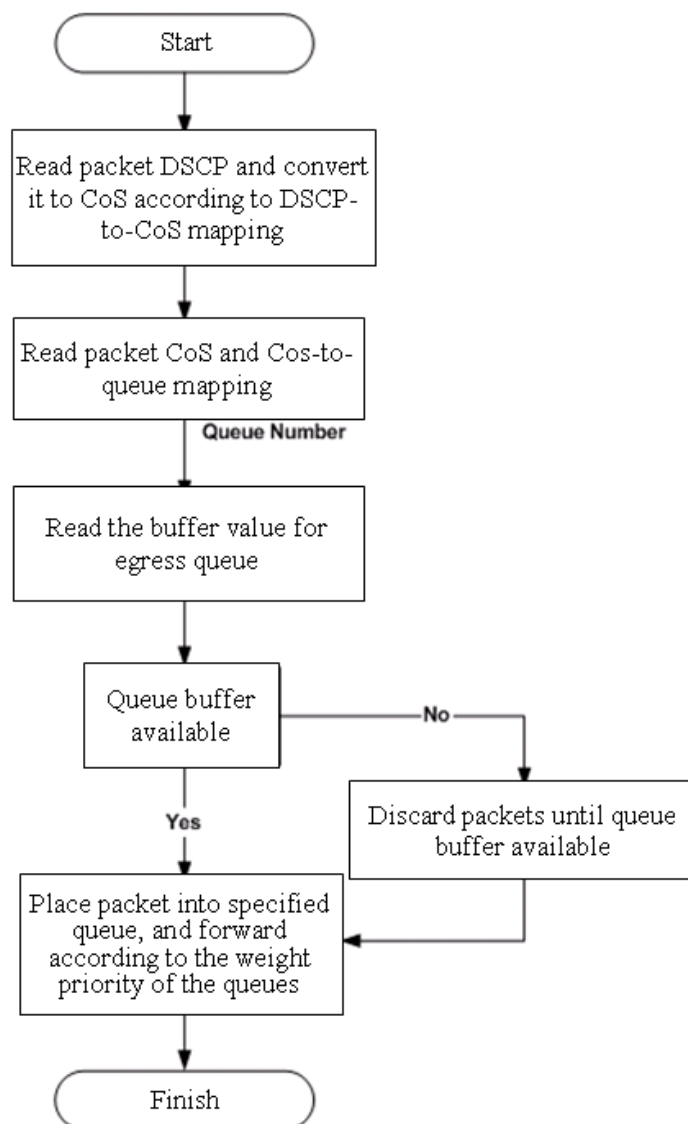

Figure 17-1-6 Queuing and Scheduling process

17.2 QoS Configuration Task List

1 · Enable QoS

QoS can be enabled or disabled in Global Mode. QoS must be enabled first in Global Mode to configure the other QoS commands.

2 · Configure class map.

Set up a classification rule according to ACL, CoS, VLAN ID, IPv4 Precedent, DSCP, IPV6 FL to classify the data stream. Different classes of data streams will be processed with different policies.

3 · Configure a policy map.

After data stream classification, a policy map can be created to associate with the class map created earlier and enter class mode. Then different policies (such as bandwidth limit, priority degrading assigning new DSCP value) can be applied to different data streams. You can also define a policy set that can be use in a policy map by several classes.

4 · Apply QoS to the ports

Configure the trust mode for ports or bind policies to ports. A policy will only take effect on a port when it is bound to that port.

5 · Configure queue out method and weight

Configure queue out to PQ or WRR, set the proportion of the 8 egress queues bandwidth and mapping from internal priority to egress queue.

6 · Configure QoS mapping

Configure the mapping from CoS to DSCP, DSCP to CoS, DSCP to DSCP mutation, IP precedence to DSCP, and policed DSCP.

1. Enable QoS

Command	Explanation
Global Mode	
mls qos no mls qos	Enable/disable QoS function.

2. Configure class map.

Command	Explanation
Global Mode	
class-map <class-map-name> no class-map <class-map-name>	Create a class map and enter class map mode; the “ no class-map <class-map-name> ” command deletes the specified class map.
match {access-group <acl-index-or-name> ip dscp <dscp-list> ip precedence <ip-precedence-list> ipv6 access-group <acl-index-or-name> ipv6 dscp <dscp-list> ipv6 flowlabel <flowlabel-list> vlan <vlan-list> / cos <cos-list>} no match {access-group ip dscp ip precedence / ipv6 access-group ipv6 dscp ipv6 flowlabel vlan cos }	Set matching criterion (classify data stream by ACL, CoS, VLAN ID, IPv4 Precedence, IPv6 FL or DSCP, etc) for the class map; the no command deletes specified matching criterion.

3. Configure a policy map

Command	Explanation
Global Mode	
policy-map <policy-map-name> no policy-map <policy-map-name>	Create a policy map and enter policy map mode; the “ no policy-map <policy-map-name> ” command deletes the specified policy map.
class <class-map-name> no class <class-map-name>	After a policy map is created, it can be associated to a class. Different policy or new DSCP value can be applied to different data streams in class mode; the “ no class <class-map-name> ” command deletes the specified class.
set {ip dscp <new-dscp> / ip precedence <new-precedence> ipv6 dscp <new-dscp> ipv6 flowlabel <new-flowlabel> ip nexthop	Assign a new DSCP, CoS, IP Precedence value for the classified traffic; the no command cancels the

<pre><ip-address> /cos <new-cos> } no set {ip dscp <new-dscp> ip precedence <new-precedence> ipv6 dscp <new-dscp> ipv6 flowlabel <new-flowlabel> ip nexthop <ip-address> cos }</pre>	<p>newly assigned value.</p>
<pre>policy <bits_per_second> <normal_burst_bytes> ({conform-action (drop set-dscp-transmit <dscp_value> set-prec-transmit <ip_precedence_value> transmit) exceed-action (drop policed-dscp-transmit transmit) }) no policy <bits_per_second> <normal_burst_bytes> ({conform-action (drop set-dscp-transmit <dscp_value> set-prec-transmit <ip_precedence_value> transmit) exceed-action (drop policed-dscp-transmit transmit)}) policy <bits_per_second> <normal_burst_bytes> (pir <peak_rate_bps>) <maximum_burst_bytes> ({conform-action (drop set-dscp-transmit <dscp_value> set-prec-transmit <ip_precedence_value> transmit) exceed-action (drop policed-dscp-transmit transmit) violate-action (drop policed-dscp-transmit transmit)}) no policy <bits_per_second> <normal_burst_bytes> (pir <peak_rate_bps>) <maximum_burst_bytes> ({conform-action (drop set-dscp-transmit <dscp_value> set-prec-transmit <ip_precedence_value> transmit) exceed-action (drop policed-dscp-transmit transmit) violate-action (drop policed-dscp-transmit transmit)})</pre>	<p>The non-aggregation policer command supporting three colors. Determine whether the working mode of token bucket is single rate single bucket, single rate single bucket, single rate dual bucket or dual rate dual bucket, by analyzing the parameters. The no command will delete the mode configuration.</p>
<pre>mls qos aggregate-policy <policer_name> <bits_per_second> <normal_burst_bytes> ({conform-action (drop set-dscp-transmit <dscp_value> set-prec-transmit <ip_precedence_value> transmit) exceed-action (drop policed-dscp-transmit transmit) }) mls qos aggregate-policy <policer_name> <bits_per_second><normal_burst_bytes>(pi r <peak_rate_bps>) <maximum_burst_bytes> ({conform-action</pre>	<p>Analyze the working mode of the token bucket, whether it is single rate single bucket, single rate dual bucket or dual rate dual bucket. This policy can be used by more than one policy class in one policy map. The no operation will delete the mode configuration.</p>

<pre>(drop set-dscp-transmit <dscp_value> set-prec-transmit <ip_precedence_value> transmit) exceed-action (drop policed-dscp-transmit transmit) violate-action (dro policed-dscp-transmit transmit)}) no mls qos aggregate-policy</pre>	
<pre>policy aggregate <aggregate-policy-name> no policy aggregate <aggregate-policy-name></pre>	Apply a policy set to classified traffic; the “no policy aggregate <aggregate-policy-name>” command deletes the specified policy set.

4. Apply QoS to port or VLAN interface

Command	Explanation
Interface Configuration Mode	
<pre>mls qos trust [cos [pass-through-dscp] [pass-through-cos] dscp [pass-through-cos] [pass-through-dscp] ip-precedence [pass-through-cos] [pass-through-dscp] port priority <cos> [pass-through-cos] [pass-through-dscp]] no mls qos trust</pre>	Configure port trust; the “no mls qos trust” command disables the current trust status of the port.
<pre>mls qos cos {<default-cos>} no mls qos cos</pre>	Configure the default CoS value of the port; the “no mls qos cos” command restores the default setting.
<pre>mls qos dscp-mutation <dscp-mutation-name> no mls qos dscp-mutation <dscp-mutation-name></pre>	Apply a DSCP transform mapping to the specified port; the no command is the default value of resume DSCP transform mapping.
<pre>service-policy input <policy-map-name> no service-policy input <policy-map-name></pre>	Apply a policy map to the specified port or VLAN interface; the no command deletes the specified policy map applied to the port or VLAN interface. Egress policy map is not supported yet.

5. Configure queue out method and weight

Command	Explanation
Interface Configuration Mode	
<pre>wrr-queue bandwidth <weight1 weight2 weight3 weight4 weight5 weight6 weight7 weight8> no wr-queue bandwidth</pre>	Sets the WRR weight for specified egress queue; the no command restores the default setting.
<pre>priority-queue out no priority-queue out</pre>	Configure queue out method to pq method; the no command restores the default WRR queue out method.

Global Mode	
wrr-queue cos-map <queue-id> <cos1 ... cos8> no wrr-queue cos-map	Set CoS value mapping to specified egress queue; the no command restores the default setting.

6. Configure QoS mapping

Command	Explanation
Global Mode	
mls qos map (cos-dscp <dscp1...dscp8> / dscp-cos <dscp-list> to <cos> / dscp-mutation <dscp-mutation-name> <in-dscp> to <out-dscp> ip-prec-dscp <dscp1...dscp8> / policed-dscp (normal-burst max-burst) <dscp-list> to <mark-down-dscp>) no mls qos map (cos-dscp dscp-cos dscp-mutation <dscp-mutation-name> ip-prec-dscp policed-dscp (normal-burst max-burst))	Support the configuration of all actions in dual rate dual bucket mode. Sets class of service (CoS)-to-Differentiated Services Code Point (DSCP) mapping, DSCP to CoS mapping, DSCP to DSCP mutation mapping, IP precedence to DSCP and policed DSCP mapping; the exceed-action and violate-action use different policed-dscp map tables. The no command restores the default mapping.

7. Apply QoS to queue of egress port

Command	Explanation
Interface Mode	
queue-bandwidth <queue-id> <min_kbits_per_second> <max_kbits_per_second> no queue-bandwidth <queue-id>	Configure the bandwidth pledge function of egress queue; the no command deletes the bandwidth configuration of queue.

17.3 QoS Example

Example 1:

Enable QoS function, change the queue out weight of port ethernet 1/1 to 1:1:2:2:4:4:8:8, and set the port in trust QoS mode without changing DSCP value, and set the default QoS value of the port to 5.

The configuration steps are listed below:

```
XGS3-42000R#config
XGS3-42000R(config)#mls qos
XGS3-42000R(config)#interface ethernet 1/1
XGS3-42000R(config-if-Ethernet1/1)#wrr-queue bandwidth 1:1:2:2:4:4:8:8
XGS3-42000R(config-if-Ethernet1/1)#mls qos trust cos pass-through-dscp
XGS3-42000R(config-if-Ethernet1/1)#mls qos cos 5
```

Configuration result:

When QoS enabled in Global Mode, the egress queue bandwidth proportion of port ethernet1/1 is 1:1:2:2:4:4:8:8. When packets have CoS value coming in through port ethernet1/1, it will be map to the queue out according to the CoS value, CoS value 0 to 7 correspond to queue out 1, 2, 3, 4, 5, 6, 7, 8, respectively. If the incoming packet has no CoS value, it is default to 5 and will be put in queue6. All passing packets would not have their DSCP values changed.

Example 2:

In port ethernet1/2, set the bandwidth for packets from segment 192.168.1.0 to 10 Mb/s, with a burst value of 4 MB, all packets exceed this bandwidth setting will be dropped.

The configuration steps are listed below:

```
XGS3-42000R#config
XGS3-42000R(config)#access-list 1 permit 192.168.1.0 0.0.0.255
XGS3-42000R(config)#mls qos
XGS3-42000R(config)#class-map c1
XGS3-42000R(config-ClassMap-c1)#match access-group 1
XGS3-42000R(config-ClassMap-c1)#exit
XGS3-42000R(config)#policy-map p1
XGS3-42000R(config-PolicyMap-p1)#class c1
XGS3-42000R(config-PolicyMap-p1-Class-c1)#policy 10000 4000 exceed-action drop
XGS3-42000R(config-PolicyMap-p1-Class-c1)#exit
XGS3-42000R(config-PolicyMap-p1)#exit
XGS3-42000R(config)#interface ethernet 1/2
XGS3-42000R(config-If-Ethernet1/2)#service-policy input p1
```

Configuration result:

An ACL name 1 is set to matching segment 192.168.1.0. Enable QoS globally, create a class map named c1, matching ACL1 in class map; create another policy map named p1 and refer to c1 in p1, set appropriate policies to limit bandwidth and burst value. Apply this policy map on port ethernet1/2. After the above settings done, bandwidth for packets from segment 192.168.1.0 through port ethernet 1/2 is set to 10 Mb/s, with a burst value of 4 MB, all packets exceed this bandwidth setting in that segment will be dropped.

Example 3:

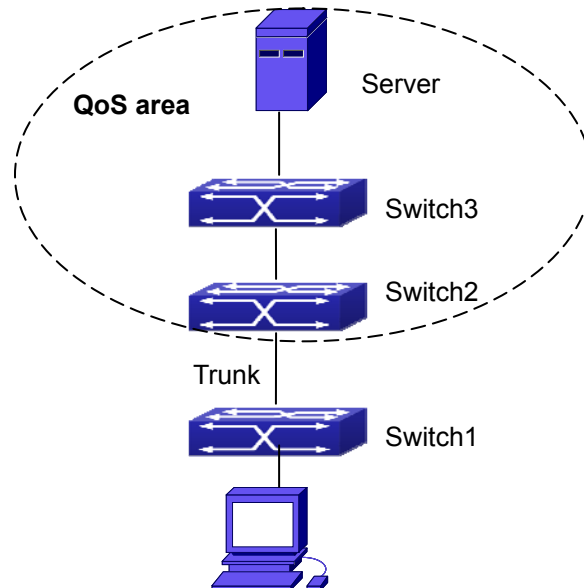

Figure 17-3-1 Typical QoS topology

As shown in the figure, inside the block is a QoS domain, Switch1 classifies different traffics and assigns different IP precedences. For example, set CoS precedence for packets from segment 192.168.1.0 to 5 on port ethernet1/1. The port connecting to switch2 is a trunk port. In Switch2, set port ethernet 1/1 that connecting to switch1 to trust CoS precedence. Thus inside the QoS domain, packets of different priorities will go to different queues and get different bandwidth.

The configuration steps are listed below:

QoS configuration in SwitchA:

```
XGS3-42000R#config
XGS3-42000R(config)#access-list 1 permit 192.168.1.0 0.0.0.255
XGS3-42000R(config)#mls qos
XGS3-42000R(config)#class-map c1
XGS3-42000R(config-ClassMap-c1)#match access-group 1
XGS3-42000R(config-ClassMap-c1)#exit
XGS3-42000R(config)#policy-map p1
XGS3-42000R(config-PolicyMap-p1)#class c1
XGS3-42000R(config-PolicyMap-p1-Class-c1)# set ip precedence 5
XGS3-42000R(config-PolicyMap-p1-Class-c1)#exit
XGS3-42000R(config-PolicyMap-p1)#exit
XGS3-42000R(config)#interface ethernet 1/1
XGS3-42000R(config-If-Ethernet1/1)#service-policy input p1
```

QoS configuration in Switch2:

```
XGS3-42000R#config
XGS3-42000R(config)#mls qos
XGS3-42000R(config)#interface ethernet 1/1
XGS3-42000R(config-if-Ethernet1/1)#mls qos trust ip-precedence pass-through-qos
```

17.4 QoS Troubleshooting

- QoS is disabled on Chassis Switch ports by default, 8 sending queues are set by default, queue1 forwards normal packets, other queues are used for some important control packets (such as BPDU).
- When QoS is enabled in Global Mode, QoS is enabled on all ports with 8 traffic queues. The default CoS value of the port is 0; the port is in not Trusted state by default; the default queue weight values are 1, 2, 3, 4, 5, 6, 7, 8. in order, all QoS Map is using the default value.
- CoS value 7 maps to queue 8 that has the highest priority and usually reserved for certain protocol packets. It is not recommended for the user to change the mapping between CoS 7 to Queue 8, or set the default port CoS value to 7.
- Policy map can only be bound to ingress direction, egress is not supported yet.

Chapter 18 PBR Configuration

18.1 Introduction to PBR

PBR (Policy-based Routing) is a method which determines the next hop of the data packets by policy messages such as source address, destination address, IP priority, TOS value, IP protocol, source port no., destination port no., etc.

18.2 PBR Configuration

The PBR configuration task list is as follows:

Initiate PBR function

Enable or disable PBR function automatically when turn on or turn off the QoS function at global mode.

Configuration classmap

Establish a class rule and apply different policies on different kinds of data streams thereafter.

Configuration policymap

A policymap can be established after the data streams are classified. Assign each stream to previously created class-map and then enter the policy class-map mode. In this way different data streams can now be assigned to different next-hop IP address and apply the policy to the port.

A policy will not be valid until it is bonded to a specified port.

18.3 PBR Examples

Example1 :

On port ethernet1/1, apply policy-based routing on packages from 192.168.1.0/24 segment, and set the next-hop as 218.31.1.119, meanwhile the local network IP of this network ranges within 192.168.0.0/16. To assure normal communication in local network, messages from 192.168.1.0/24 to local IP 192.168.0.0/16 are not applied with policy routing.

Configuration procedure is as follows:

```
XGS3-42000R#config
XGS3-42000R(config)#access-list ip extended a1
XGS3-42000R(config-IP-Ext-Nacl-a1)#permit ip 192.168.1.0 0.0.0.255 any-destination
XGS3-42000R(config-IP-Ext-Nacl-a1)#deny ip 192.168.1.0 0.0.0.255 192.168.0.0 0.0.255.255
XGS3-42000R(config-IP-Ext-Nacl-a1)#exit
XGS3-42000R(config)#mls qos
XGS3-42000R(config)#class-map c1
```

```
XGS3-42000R(config-ClassMap-c1)#match access-group a1
XGS3-42000R(config-ClassMap-c1)# exit
XGS3-42000R(config)#policy-map p1
XGS3-42000R(config-PolicyMap-p1)#class c1
XGS3-42000R(config-PolicyMap-p1-Class-c1)#set ip nexthop 218.31.1.119
XGS3-42000R(config-PolicyMap-p1-Class-c1)#exit
XGS3-42000R(config-PolicyMap-p1)#exit
XGS3-42000R(config)#interface ethernet 1/1
XGS3-42000R(config-If-Ethernet1/1)#service-policy input p1
```

Configuration results:

First set an ACL a1 with two items. The first item matches source IP segments 192.168.1.0/24 (allowed) . The second item matches source IP segments 192.168.1.0/24 and destination IP segments 192.168.0.0/16 (rejected) . Turn on QoS function in global mode and create a class-map: c1 in which matches ACL a1, and create a policy-map in which quote c1. Set the next-hop IP as 218.31.1.119 and apply the policy-map at port ethernet1/1. After that, all messages on port ethernet 1/1 from segment 192.168.1.0/24 will be transmitted through 218.31.1.119 except those from 192.168.0.0/16 segment which are still be transmitted through normal L3 routing.

Chapter 19 IPv6 PBR Configuration

19.1 Introduction to PBR (Policy-based Router)

Policy-based routing provides a more powerful control over the forwarding and store of messages than traditional routing protocol to network managers. Traditionally, routers use the routing table derived from router protocol, and forward according to destination addresses. The policy-based router is more powerful and more flexible than the traditional one, because it enables network managers to choose the forwarding route not only according to destination addresses but also the size of messages, or source IP addresses. Policy can be defined as according to the balance of load in multiple routers or according to the quality of service (QOS) of the total flow forwarded in each line.

PBR (Policy-based Routing) is a method which politically specifies the next hop when forwarding a data packet according to the source address, destination address, IP priority, TOS value, IP protocol, source port, destination port and other information of an IP packet.

19.2 PBR Configuration Task Sequence

1. Enable PBR function
2. Configure a class-map
3. Set the match standard in the class-map
4. Configure a policy-map
5. Configure to correlate a policy and a class-map
6. Configure the next hop IPv6 address
7. Configure the port binding policy map

1. Enable PBR function

Command	Explanation
Global Configuration Mode	
mls qos no mls qos	Globally enable or disable PBR function.

2. Configure a class-map

Command	Explanation
Global Configuration Mode	
class-map <class-map-name> no class-map <class-map-name>	Create or delete a class-map.

3. Set the match standard in the class-map

Command	Explanation
Class-map Mode	
match ipv6 {access-group <acl-index-or-name> no match ipv6 {access-group }	Set the match standard in the class-map.

4. Configure a policy-map

Command	Explanation
Global Configuration Mode	
policy-map <policy-map-name> no policy-map <policy-map-name>	Create or delete a policy-map.

5. Configure to correlate a policy and a class-map

Command	Explanation
Policy-map Mode	
class <class-map-name> no class <class-map-name>	Correlate with a class, and enter the policy-map mode.

6. Configure the next hop IPv6 address

Command	Explanation
Policy-class-map Mode	
set {ipv6 nexthop <nexthop-ip> no set {ipv6 nexthop}	Set the next hop IPv6 address of the classed flow.

7. Configure the port binding policy-map

Command	Explanation
Port Configuration Mode	
service-policy {input <policy-map-name> output <policy-map-name> no service-policy {input <policy-map-name> output <policy-map-name>	Configure the trust state of a port is mutually exclusive to applying policy-map on a port. After configure the trust state of a port or applying policy-map, if this port needs to configure new trust state or applying policy-map, then deleting the old configuration at first; there can be only one policy-map on each direction of a port. The output policy-map is not supported at present.

19.3 PBR Examples

Example 1:

On port ethernet 1/1, set the messages whose source IP is within the segment 2000:: /64 to do policy routing, the next hop is 3100::2.

The following is the configuration steps:

```
XGS3-42000R#config
XGS3-42000R(config)#interface vlan 1
XGS3-42000R(config-if-Vlan1)#ipv6 address 2000::1/64
XGS3-42000R(config-if-Vlan1)#ipv6 neighbor 2000::2 00-00-00-00-00-01 interface Ethernet 1/1
XGS3-42000R(config)#interface vlan 2
XGS3-42000R(config-if-Vlan2)#ipv6 address 3000::1/64
XGS3-42000R(config-if-Vlan2)#ipv6 neighbor 3000::2 00-00-00-00-00-02 interface Ethernet 1/2
XGS3-42000R(config)#interface vlan 3
XGS3-42000R(config-if-Vlan3)#ipv6 address 3100::1/64
XGS3-42000R(config-if-Vlan3)#ipv6 neighbor 3100::2 00-00-00-00-00-03 interface Ethernet 1/5
XGS3-42000R(config)# ipv6 access-list extended b1
XGS3-42000R(config-IPv6-Ext-Nacl-b1)# permit tcp 2000:: /64 any-destination
XGS3-42000R(config-IPv6-Ext-Nacl-b1)#exit
XGS3-42000R(config)#mls qos
XGS3-42000R(config)#class-map c1
XGS3-42000R(config-ClassMap)#match ipv6 access-group b1
XGS3-42000R(config-ClassMap)# exit
XGS3-42000R(config)#policy-map p1
XGS3-42000R(config-PolicyMap)#class c1
XGS3-42000R(config-Policy-Class)# set ipv6 nexthop 3100::2
XGS3-42000R(config--Policy-Class)#exit
XGS3-42000R(config-PolicyMap)#exit
XGS3-42000R(config)#interface ethernet 1/1
XGS3-42000R(config-Ethernet1/1)#service-policy input p1
```

Configuration result:

First, set an ACL containing one entry, names it as b1, matching source IP segment 2000::/64(permit). Globally enable QoS function, create a class-map:c1, and match ACL b1 in the class-map. Create a policy-map:p1, quoting c1 in p1, and set the next hop as 3100::2. Apply this policy-map on port ethernet 1/1. After that, the messages whose source IP are within the segment 2000::/64 received on port ethernet 1/1 will be forwarded through 3100::2.

19.4 PBR Troubleshooting Help

- At present, policy-map can only be bound to input port but not output port.
- Since hardware resources are limited, if the policy is too complicated to configure, relative information will be noticed to users.

Chapter 20 Flow-based Redirection

20.1 Introduction to Flow-based Redirection

Flow-based redirection function enables the Chassis Switch to transmit the data frames meeting some special condition (specified by ACL) to another specified port. The frames meeting a same special condition are called a class of flow, the ingress port of the data frame is called the source port of redirection, and the specified egress port is called the destination port of redirection. Usually there are two kinds of application of flow-based redirection: 1. connecting a protocol analyzer (for example, Sniffer) or a RMON monitor to the destination port of redirection, to monitor and manage the network, and diagnose the problems in the network; 2. Special transmission policy for a special type of data frames.

The Chassis Switch can only designate a single destination port of redirection for a same class of flow within a source port of redirection, while it can designate different destination ports of redirection for different classes of flows within a source port of redirection. The same class of flow can be applied to different source ports.

20.2 Flow-based Redirection Configuration Task Sequence

- 1 · Flow-based redirection configuration
- 2 · Check the current flow-based redirection configuration

1. Flow-based redirection configuration

Command	Explanation
Physical Interface Configuration Mode	
access-group <aclname> redirect to interface [ethernet <IFNAME> <IFNAME>] no access-group <aclname> redirect	Specify flow-based redirection for the port; the “no access-group <aclname> redirect” command is used to delete flow-based redirection.

2. Check the current flow-based redirection configuration

Command	Explanation
Global Mode/Admin Mode	
show flow-based-redirect {interface [ethernet <IFNAME> <IFNAME>]}	Display the information of current flow-based redirection in the system/port.

20.3 Flow-based Redirection Examples

Example:

User's request of configuration is listed as follows: redirecting the frames whose source IP is 192.168.1.111 received from port 1 to port 6, that is sending the frames whose source IP is 192.168.1.111 received from port 1 through port 6.

Modification of configuration:

- 1: Set an ACL, the condition to be matched is: source IP is 192.168.1.111;
- 2: Apply the redirection based on this flow to port 1.

The following is the configuration procedure:

```
XGS3-42000R(config)#access-list 1 permit host 192.168.1.111
XGS3-42000R(config)#interface ethernet 1/1
XGS3-42000R(config-If-Ethernet1/1)# access-group 1 redirect to interface ethernet 1/6
```

20.4 Flow-based Redirection Troubleshooting Help

When the configuration of flow-based redirection fails, please check whether the following reasons are causing the problem:

- The type of flow (ACL) can only be digital standard IP ACL, digital extensive IP ACL, nomenclature standard IP ACL, nomenclature extensive IP ACL, digital standard IPv6 ACL, and nomenclature standard IPv6 ACL;
- Parameters of **Timerange** and **Portrange** cannot be set in ACL, the type of ACL should be Permit.
- The redirection port must be 1000Mb port in the flow-based redirection function.

Chapter 21 Layer 3 Forward Configuration

Chassis Switch supports Layer 3 forwarding which forwards Layer 3 protocol packets (IP packets) across VLANs. Such forwarding uses IP addresses when an interface receives an IP packet. It will perform a lookup in its own routing table and decide the operation according to the lookup result. If the IP packet is destined to another subnet reachable from this Chassis Switch, then the packet will be forwarded to the appropriate interface. Chassis Switch can forward IP packets by hardware, The forwarding chip of Chassis Switch has a host route table and default route table. Host route table stores host routes to connect to the Chassis Switch directly; default route table stores network routes (after aggregation algorithm process).

If the route (either host route or network route) for forwarding unicast traffic exists in the forwarding chip, the forwarding of traffic will be completely handled by hardware. As a result, forwarding efficiency can be greatly improved, even to wire speed.

21.1 Layer 3 Interface

21.1.1 Introduction to Layer 3 Interface

Layer 3 interface can be created on Chassis Switch. The Layer 3 interface is not a physical interface but a virtual interface. Layer 3 interface is built on VLANs. The Layer 3 interface can contain one or more layer 2 ports which belong to the same VLAN, or contain no layer 2 ports. At least one of the Layer 2 ports contained in Layer 3 interface should be in UP state for Layer 3 interface in UP state, otherwise, Layer 3 interface will be in DOWN state. All layer 3 interfaces in the Chassis Switch use the same MAC address by default, this address is selected from the reserved MAC address while creating Layer 3 interface. The Layer 3 interface is the base for layer 3 protocols. The Chassis Switch can use the IP addresses set in the layer 3 interfaces to communicate with the other devices via IP. The Chassis Switch can forward IP packets between different Layer 3 interfaces. Loopback interface belongs to Layer 3 interface.

21.1.2 Layer 3 Interface Configuration Task List

Layer 3 Interface Configuration Task List:

1. Create Layer 3 interface
2. Bandwidth for Layer 3 Interface configuration
3. Open or close the VLAN interface

1. Create Layer 3 Interface

Command	Explanation
Global Mode	

interface vlan <vlan-id> no interface vlan <vlan-id>	Creates a VLAN interface (VLAN interface is a Layer 3 interface); the no command deletes the VLAN interface (Layer 3 interface) created in the Chassis Switch.
interface loopback <loopback-id> no interface loopback <loopback-id>	Creates a Loopback interface then enter the loopback Port Mode; the no command deletes the Loopback interface created in the Chassis Switch.

2. Bandwidth for Layer 3 Interface configuration

Command	Explanation
VLAN Interface Mode	
bandwidth <bandwidth> no bandwidth	Configure the bandwidth for Layer 3 Interface. The no command recovery the default value.

3. Open or close the VLAN interface

Command	Explanation
VLAN Interface Mode	
shutdown no shutdown	Open or close the VLAN interface.

21.2 IP Configuration

21.2.1 Introduction to IPv4, IPv6

IPv4 is the current version of global universal Internet protocol. The practice has proved that IPv4 is simple, flexible, open, stable, strong and easy to implement while collaborating well with various protocols of upper and lower layers. Although IPv4 almost has not been changed since it was established in 1980's, it has kept growing to the current global scale with the promotion of Internet. However, as Internet infrastructure and Internet application services continue boosting, IPv4 has shown its deficiency when facing the present scale and complexity of Internet.

IPv6 refers to the sixth version of Internet protocol which is the next generation Internet protocol designed by IETF to replace the current **Internet protocol version 4 (IPv4)**. IPv6 was specially developed to make up the shortages of IPv4 addresses so that Internet can develop further.

The most important problem IPv6 has solved is to add the amount of IP addresses. IPv4 addresses have nearly run out, whereas the amount of Internet users has been increasing in geometric series. With the greatly and continuously boosting of Internet services and application devices (Home and Small Office Network, IP phone and Wireless Service Information Terminal which make use of Internet,) which require IP addresses, the supply of IP addresses turns out to be more and more tense. People have been working on the problem of shortage of IPv4 addresses for a long time by introducing various technologies to prolong the lifespan of existing IPv4 infrastructure, including **Network Address Translation(NAT for short)**, and **Classless Inter-Domain Routing(CIDR for short)**, etc.

Although the combination of CIDR, NAT and private addressing has temporarily mitigated the problem of IPv4 address space shortage, NAT technology has disrupted the end-to-end model which is the original intention of IP design by making it necessary for router devices that serve as network intermediate nodes to maintain every connection status which increases network delay greatly and decreases network performance. Moreover, the translation of network data packet addresses baffles the end-to-end network security check, IPSec authentication header is such an example.

Therefore, in order to solve all kinds of problems existing in IPv4 comprehensively, the next generation Internet Protocol IPv6 designed by IETF has become the only feasible solution at present.

First of all, the 128 bits addressing scheme of IPv6 Protocol can guarantee to provide enough globally unique IP addresses for global IP network nodes in the range of time and space. Moreover, besides increasing address space, IPv6 also enhanced many other essential designs of IPv4.

Hierarchical addressing scheme facilitates Route Aggregation, effectively reduces route table entries and enhances the efficiency and expansibility of routing and data packet processing.

The header design of IPv6 is more efficient compared with IPv4. It has less data fields and takes out header checksum, thus expedites the processing speed of basic IPv6 header. In IPv6 header, fragment field can be shown as an optional extended field, so that data packets fragmentation process won't be done in router forwarding process, and Path MTU Discovery Mechanism collaborates with data packet source which enhances the processing efficiency of router.

Address automatic configuration and plug-and-play is supported. Large amounts of hosts can find network routers easily by address automatic configuration function of IPv6 while obtaining a globally unique IPv6 address automatically as well which makes the devices using IPv6 Internet plug-and-play. Automatic address configuration function also makes the readdressing of existing network easier and more convenient, and it is more convenient for network operators to manage the transformation from one provider to another.

Support IPSec. IPSec is optional in IPv4, but required in IPv6 Protocol. IPv6 provides security extended header, which provides end-to-end security services such as access control, confidentiality and data integrity, consequently making the implement of encryption, validation and Virtual Private Network easier.

Enhance the support for Mobile IP and mobile calculating devices. The Mobile IP Protocol defined in IETF standard makes mobile devices movable without cutting the existing connection, which is a network function getting more and more important. Unlike IPv4, the mobility of IPv6 is from embedded automatic configuration to get transmission address (Care-Of-Address); therefore it doesn't need Foreign Agent. Furthermore, this kind of binding process enables Correspondent Node communicate with Mobile Node directly, thereby avoids the extra system cost caused by triangle routing choice required in IPv4.

Avoid the use of Network Address Translation. The purpose of the introduction of NAT mechanism is to share and reuse same address space among different network segments. This mechanism mitigates the problem of the shortage of IPv4 address temporally; meanwhile it adds the burden of address translation process for network device and application. Since the address space of IPv6 has increased greatly, address translation becomes unnecessary, thus the problems and system cost caused by NAT deployment are solved naturally.

Support extensively deployed Routing Protocol. IPv6 has kept and extended the supports for existing **Internal Gateway Protocols (IGP for short)**, and **Exterior Gateway Protocols (EGP for short)**. For example, IPv6 Routing Protocol such as RIPng, OSPFv3, IS-ISv6 and MBGP4+, etc.

Multicast addresses increased and the support for multicast has enhanced. By dealing with IPv4 broadcast functions such as Router Discovery and Router Query, IPv6 multicast has completely replaced IPv4

broadcast in the sense of function. Multicast not only saves network bandwidth, but enhances network efficiency as well.

21.2.2 IP Configuration

Layer 3 interface can be configured as IPv4 interface or IPv6 interface.

21.2.2.1 IPv4 Address Configuration

IPv4 address configuration task list:

- 1 · Configure the IPv4 address of three-layer interface

1 · Configure the IPv4 address of three-layer interface

Command	Explanation
VLAN Interface Configuration Mode	
ip address <ip-address> <mask> [secondary] no ip address [<ip-address> <mask>]	Configure IP address of VLAN interface; the no ip address [<ip-address> <mask>] command cancels IP address of VLAN interface.

21.2.2.2 IPv6 Address Configuration

The configuration Task List of IPv6 is as follows:

1. IPv6 basic configuration
 - (1) Globally enable IPv6
 - (2) Configure interface IPv6 address
 - (3) Configure IPv6 static routing
2. IPv6 Neighbor Discovery Configuration
 - (1) Configure DAD neighbor solicitation message number
 - (2) Configure send neighbor solicitation message interval
 - (3) Enable and disable router advertisement
 - (4) Configure router lifespan
 - (5) Configure router advertisement minimum interval
 - (6) Configure router advertisement maximum interval
 - (7) Configure prefix advertisement parameters
 - (8) Configure static IPv6 neighbor entries
 - (9) Delete all entries in IPv6 neighbor table
 - (10) Set the hoplimit of sending router advertisement
 - (11) Set the mtu of sending router advertisement
 - (12) Set the reachable-time of sending router advertisement
 - (13) Set the retrans-timer of sending router advertisement

(14) Set the flag representing whether information other than the address information will be obtained via DHCPv6

(15) Set the flag representing whether the address information will be obtained via DHCPv6

3. IPv6 Tunnel configuration

- (1) Create/Delete Tunnel
- (2) Configure tunnel description
- (3) Configure Tunnel Source
- (4) Configure Tunnel Destination
- (5) Configure Tunnel Next-Hop
- (6) Configure Tunnel Mode
- (7) Configure Tunnel Routing

1. IPv6 Basic Configuration

(1) Globally enable IPv6

Command	Explanation
Global mode	
ipv6 enable no ipv6 enable	Enable functions such as IPv6 data packet transmission, neighbor discovery, router advertisement, routing protocol, etc. The NO command disables IPv6 function.

(2) Configure interface IPv6 address

Command	Explanation
Interface Configuration Mode	
ipv6 address <ipv6-address/prefix-length> [eui-64] no ipv6 address <ipv6-address/prefix-length>	Configure IPv6 address, including aggregatable global unicast addresses, site-local addresses and link-local addresses. The no ipv6 address <ipv6-address/prefix-length> command cancels IPv6 address.

(3) Set IPv6 Static Routing

Command	Explanation
Global mode	
ipv6 route <ipv6-prefix/prefix-length> {<nexthop-ipv6-address> <interface-type interface-number> {<nexthop-ipv6-address> <interface-type interface-number>}} [distance] no ipv6 route <ipv6-prefix/prefix-length> {<nexthop-ipv6-address> <interface-type interface-number> {<nexthop-ipv6-address> <interface-type interface-number>}} [distance]	Configure IPv6 static routing. The no command cancels IPv6 static routing.

2. IPv6 Neighbor Discovery Configuration

(1) Configure DAD Neighbor solicitation Message number

Command	Explanation
Interface Configuration Mode	
ipv6 nd dad attempts <value> no ipv6 nd dad attempts <value>	Set the neighbor query message number sent in sequence when the interface makes duplicate address detection. The no command resumes default value (1).

(2) Configure Send Neighbor solicitation Message Interval

Command	Explanation
Interface Configuration Mode	
ipv6 nd ns-interval <seconds> no ipv6 nd ns-interval <seconds>	Set the interval of the interface to send neighbor query message. The NO command resumes default value (1 second).

(3) Enable and disable router advertisement

Command	Explanation
Interface Configuration Mode	
ipv6 nd suppress-ra no ipv6 nd suppress-ra	Forbid IPv6 Router Advertisement. The NO command enables IPv6 router advertisement.

(4) Configure Router Lifespan

Command	Explanation
Interface Configuration Mode	
ipv6 nd ra-lifetime <seconds> no ipv6 nd ra-lifetime <seconds>	Configure Router advertisement Lifespan. The NO command resumes default value (1800 seconds).

(5) Configure router advertisement Minimum Interval

Command	Description
Interface Configuration Mode	
ipv6 nd min-ra-interval <seconds> no ipv6 nd min-ra-interval <seconds>	Configure the minimum interval for router advertisement. The NO command resumes default value (200 seconds).

(6) Configure router advertisement Maximum Interval

Command	Explanation
Interface Configuration Mode	
ipv6 nd max-ra-interval <seconds> no ipv6 nd max-ra-interval <seconds>	Configure the maximum interval for router advertisement. The NO command resumes default value (600 seconds).

(7) Configure prefix advertisement parameters

Command	Explanation
Interface Configuration Mode	
ipv6 nd prefix <ipv6-address/prefix-length> <valid-lifetime> <preferred-lifetime> [off-link] [no-autoconfig] no ipv6 nd prefix <ipv6-address/prefix-length> <valid-lifetime> <preferred-lifetime> [off-link] [no-autoconfig]	Configure the address prefix and advertisement parameters of router. The NO command cancels the address prefix of routing advertisement.

(8) Configure static IPv6 neighbor Entries

Command	Explanation
Interface Configuration Mode	
ipv6 neighbor <ipv6-address> <hardware-address> interface <interface-type interface-number>	Set static neighbor table entries, including neighbor IPv6 address, MAC address and two-layer port.
no ipv6 neighbor <ipv6-address>	Delete neighbor table entries.

(9) Delete all entries in IPv6 neighbor table

Command	Explanation
Admin Mode	
clear ipv6 neighbors	Clear all static neighbor table entries.

(10) Set the hoplimit of sending router advertisement

Command	Explanation
Interface Configuration Mode	
ipv6 nd ra-hoplimit <value>	Set the hoplimit of sending router advertisement.

(11) Set the mtu of sending router advertisement

Command	Explanation
Interface Configuration Mode	
ipv6 nd ra-mtu <value>	Set the mtu of sending router advertisement.

(12) Set the reachable-time of sending router advertisement

Command	Explanation
Interface Configuration Mode	
ipv6 nd reachable-time <seconds>	Set the reachable-time of sending router advertisement.

(13) Set the retrans-timer of sending router advertisement

Command	Explanation
Interface Configuration Mode	
ipv6 nd retrans-timer <seconds>	Set the retrans-timer of sending router advertisement.

(14) Set the flag representing whether information other than the address information will be obtained via DHCPv6.

Command	Explanation
Interface Configuration Mode	
ipv6 nd other-config-flag	Set the flag representing whether information other than the address information will be obtained via DHCPv6.

(15) Set the flag representing whether the address information will be obtained via DHCPv6

Command	Explanation
Interface Configuration Mode	
ipv6 nd managed-config-flag	Set the flag representing whether the address information will be obtained via DHCPv6.

3. IPv6 Tunnel Configuration

(1) Add/Delete tunnel

Command	Explanation
Global mode	
interface tunnel <tnl-id> no interface tunnel <tnl-id>	Create a tunnel. The NO command deletes a tunnel.

(2) Configure tunnel description

Command	Explanation
Tunnel Configuration Mode	
description <desc> no description <desc>	Configure tunnel description. The NO command deletes the tunnel description.

(3) Configure tunnel source

Command	Explanation
Tunnel Configuration Mode	
[tunnel source { <ipv4-address> / <interface-name> } no tunnel source { <ipv4-address> / <interface-name> }]	Configure tunnel source end IPv4 address. The NO command deletes the IPv4 address of tunnel source end.

(4) Configure Tunnel Destination

Command	Explanation
Tunnel Configuration Mode	
tunnel destination <ipv4-address> no tunnel destination <ipv4-address>	Configure tunnel destination end IPv4 address. The NO command deletes the IPv4 address of tunnel destination end.

(5) Configure Tunnel Next-Hop

Command	Explanation
Tunnel Configuration Mode	
tunnel nexthop <ipv4-address> no tunnel nexthop <ipv4-address>	Configure tunnel next-hop IPv4 address. The NO command deletes the IPv4 address of tunnel next-hop end.

(6) Configure Tunnel Mode

Command	Explanation
Tunnel Configuration Mode	
tunnel mode ipv6ip [6to4 isatap] no tunnel mode ipv6ip [6to4 isatap]	Configure tunnel mode. The NO command clears tunnel mode.

(7) Configure Tunnel Routing

Command	Explanation
Global mode	
ipv6 route <ipv6-address/prefix-length> {<interface-type interface-number> tunnel <tnl-id>} no ipv6 route <ipv6-address/prefix-length> {<interface-type interface-number> tunnel <tnl-id>}	Configure tunnel routing. The NO command clears tunnel routing.

21.2.3 IP Configuration Examples

21.2.3.1 Configuration Examples of IPv4

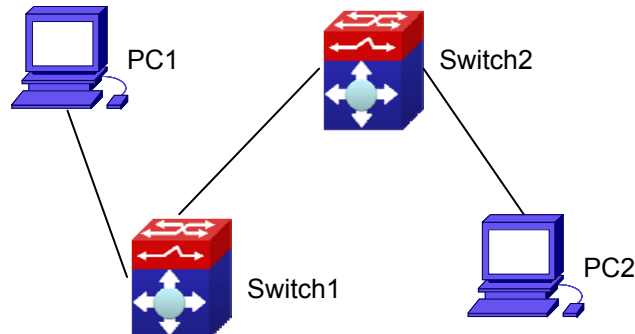

Figure 21-2-1 IPv4 configuration example

The user's configuration requirements are: Configure IP address of different network segments on Switch1 and Switch2, and configure static routing and validate accessibility using ping function.

Configuration Description:

- 1 · Configure two VLANs on Switch1, namely, VLAN1 and VLAN2.
- 2 · Configure IPv4 address 192.168.1.1 255.255.255.0 in VLAN1 of Switch1, and configure IPv4 address 192.168.2.1 255.255.255.0 in VLAN2.
- 3 · Configure two VLANs on Switch2, respectively VLAN2 and VLAN3.
- 4 · Configure IPv4 address 192.168.2.2 255.255.255.0 in VLAN2 of Switch2, and configure IPv4 address 192.168.3.1 255.255.255.0 in VLAN3.
- 5 · The IPv4 address of PC1 is 192.168.1.100 255.255.255.0, and the IPv4 address of PC2 is 192.168.3.100 255.255.255.0.
- 6 · Configure static routing 192.168.3.0/24 on Switch1, and configure static routing 192.168.1.0/24 on Switch2.
- 7 · Ping each other among PCs.



First make sure PC1 and Switch can access each other by ping, and PC2 and Switch2 can access each other by ping.

The configuration procedure is as follows:

```
Switch1(config)#interface vlan 1
Switch1(Config-if-Vlan1)#ip address 192.168.1.1 255.255.255.0
Switch1(config)#interface vlan 2
Switch1(Config-if-Vlan2)#ip address 192.168.2.1 255.255.255.0
Switch1(Config-if-Vlan2)#exit
```

```
Switch1(config)#ip route 192.168.3.0 255.255.255.0 192.168.2.2
```

```
Switch2(config)#interface vlan 2
```

```
Switch2(Config-if-Vlan2)#ip address 192.168.2.2 255.255.255.0
```

```
Switch2(config)#interface vlan 3
```

```
Switch2(Config-if-Vlan3)#ip address 192.168.3.1 255.255.255.0
```

```
Switch2(Config-if-Vlan3)#exit
```

```
Switch2(config)#ip route 192.168.1.0 255.255.255.0 192.168.2.1
```

21.2.3.2 Configuration Examples of IPv6

Example 1:

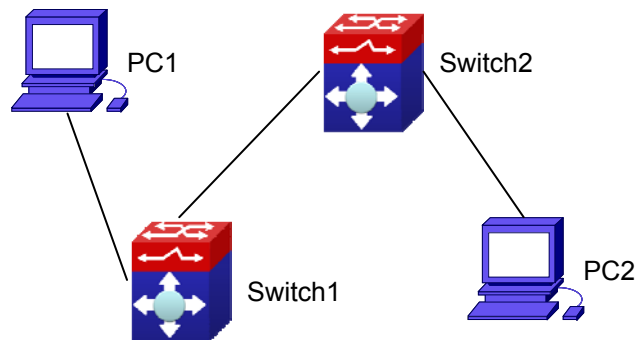
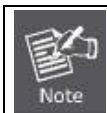

Figure 21-2-2 IPv6 configuration example

The user's configuration requirements are: Configure IPv6 address of different network segments on Switch1 and Switch2, and configure static routing and validate reachability using ping6 function.

Configuration Description:

- 1 · Configure two VLANs on Switch1, namely, VLAN1 and VLAN2.
- 2 · Configure IPv6 address 2001::1/64 in VLAN1 of Switch1, and configure IPv6 address 2002::1/64 in VLAN2.
- 3 · Configure 2 VLANs on Switch2, namely, VLAN2 and VLAN3.
- 4 · Configure IPv6 address 2002::2/64 in VLAN2 of Switch2, and configure IPv6 address 2003::1/64 in VLAN3.
- 5 · The IPv6 address of PC1 is 2001::11/64, and the IPv6 address of PC2 is 2003::33/64.
- 6 · Configure static routing 2003::33/64 on Switch1, and configure static routing 2001::11/64 on Switch2.
- 7 · ping6 each other among PCs.



First make sure PC1 and Switch1 can access each other by ping, and PC2 and Switch2 can access each other by ping.

The configuration procedure is as follows:

```
Switch1(Config)#ipv6 enable
Switch1(Config)#interface vlan 1
Switch1(Config-if-Vlan1)#ipv6 address 2001::1/64
Switch1(Config)#interface vlan 2
Switch1(Config-if-Vlan2)#ipv6 address 2002::1/64
Switch1(Config-if-Vlan2)#exit
Switch1(Config)#ipv6 route 2003::33/64 2002::2
Switch2(Config)#ipv6 enable
Switch2(Config)#interface vlan 2
```

```
Switch2(Config-if-Vlan2)#ipv6 address 2002::2/64
Switch2(Config)#interface vlan 3
Switch2(Config-if-Vlan3)#ipv6 address 2003::1/64
Switch2(Config-if-Vlan3)#exit
Switch2(Config)#ipv6 route 2001::33/64 2002::1
Switch1#ping6 2003::33
```

Configuration result:

```
Switch1#show run
interface Vlan1
  ipv6 address 2001::1/64
!
interface Vlan2
  ipv6 address 2002::2/64
!
interface Loopback
  mtu 3924
!
ipv6 route 2003::/64 2002::2
!
no login
!
end

Switch2#show run
interface Vlan2
  ipv6 address 2002::2/64
!
interface Vlan3
  ipv6 address 2003::1/64
!
interface Loopback
  mtu 3924
!
ipv6 route 2001::/64 2002::1
!
no login
!
End
```

Example 2:

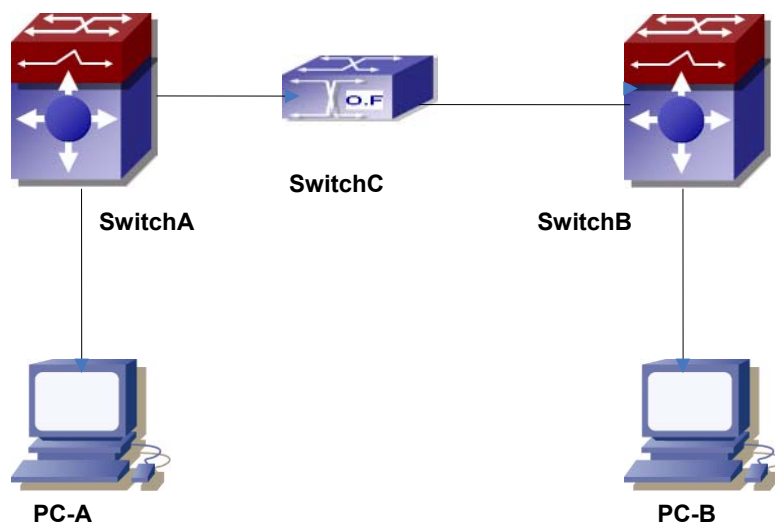

Figure 21-2-3 IPv6 tunnel

This case is IPv6 tunnel with the following user configuration requirements: SwitchA and SwitchB are tunnel nodes, and dual-stack is supported. SwitchC only runs IPv4, PC-A and PC-B communicate.

Configuration Description:

1. Configure two VLANs on SwitchA, namely, VLAN1 and VLAN2. VLAN1 is IPv6 domain, VLAN2 connects to IPv4 domain.
2. Configure IPv6 address 2002:caca:ca01:2::1/64 in VLAN1 of SwitchA and turn on RA function, configure IPv4 address 202.202.202.1 in VLAN2.
3. Configure two VLANs on SwitchB, namely, VLAN3 and VLAN4, VLAN4 is IPv6 domain, and VLAN3 connects to IPv4 domain.
4. Configure IPv6 address 2002:cacb:cb01:2::1/64 in VLAN4 of SwitchB and turn on RA function, configure IPv4 address 203.203.203.1 on VLAN3.
5. Configure tunnel on SwitchA, the source IPv4 address of the tunnel is 202.202.202.1, the tunnel routing is ::/0
6. Configure tunnel on SwitchB, the source IPv4 address of the tunnel is 202.202.202.2, and the tunnel routing is ::/0
7. Configure two VLANs on SwitchC, namely, VLAN2 and VLAN3. Configure IPv4 address 202.202.202.202 on VLAN2 and configure IPv4 address 203.203.203.203 on VLAN3.
8. PC-A and PC-B get the prefix of 2002 via SwitchA and SwitchB to configure IPv6 address automatically.
9. On PC-A, ping IPv6 address of PC-B

The configuration procedure is as follows:

```
SwitchA(config)#ipv6 enable
SwitchA(Config-if-Vlan1)#ipv6 address 2002:caca:ca01:2::1/64
SwitchA(Config-if-Vlan1)#no ipv6 nd suppress-ra
SwitchA(Config-if-Vlan1)#interface vlan 2
SwitchA(Config-if-Vlan2)#ipv4 address 202.202.202.1 255.255.255.0
SwitchA(Config-if-Vlan1)#exit
SwitchA(config)# interface tunnel 1
SwitchA(Config-if-Tunnel1)#tunnel source 202.202.202.1
SwitchA(Config-if-Tunnel1)#tunnel destination 203.203.203.1
SwitchA(Config-if-Tunnel1)#tunnel mode ipv6ip
SwitchA(config)#ipv6 route ::/0 tunnel1

SwitchB(config)#ipv6 enable
SwitchB(Config-if-Vlan4)#ipv6 address 2002:cacb:cb01::2/64
SwitchB(Config-if-Vlan4)#no ipv6 nd suppress-ra
SwitchB (Config-if-Vlan3)#interface vlan 3
SwitchB (Config-if-Vlan2)#ipv4 address 203.203.203.1 255.255.255.0
SwitchB (Config-if-Vlan1)#exit
SwitchB(config)#interface tunnel 1
SwitchB(Config-if-Tunnel1)#tunnel source 203.203.203.1
SwitchB(Config-if-Tunnel1)#tunnel destination 202.202.202.1
SwitchB(Config-if-Tunnel1)#tunnel mode ipv6ip
SwitchB(config)#ipv6 route ::/0 tunnel1
```

21.2.4 IPv6 Troubleshooting

- IPv6 on-off must be turned on when configuring IPv6 commands, otherwise the configuration is invalid.
- The router lifespan configured should not be smaller than the Send Router advertisement Interval. If the connected PC has not obtained IPv6 address, you should check the RA announcement Chassis XGS3-42000R (the default is turned off)

21.3 IP Forwarding

21.3.1 Introduction to IP Forwarding

Gateway devices can forward IP packets from one subnet to another; such forwarding uses routes to find a path. IP forwarding of switch is done with the participation of hardware, and can achieve wire speed forwarding. In addition, flexible management is provided to adjust and monitor forwarding. Chassis Switch supports aggregation algorithm enabling/disabling optimization to adjust generation of network route entry in the switch chip and view statistics for IP forwarding and hardware forwarding chip status.

21.3.2 IP Route Aggregation Configuration Task

IP route aggregation configuration task:

1. Set whether IP route aggregation algorithm with/without optimization should be used

1. Set whether IP route aggregation algorithm with/without optimization should be used

Command	Explanation
Global Mode	
ip fib optimize no ip fib optimize	Enables the switch to use optimized IP route aggregation algorithm; the “ no ip fib optimize ” disables the optimized IP route aggregation algorithm.

21.4 URPF

21.4.1 Introduction to URPF

URPF (Unicast Reverse Path Forwarding) introduces the RPF technology applied in multicast to unicast, so to protect the network from the attacks which is based on source address cheat.

When Chassis Switch receives the packet, it will search the route in the route table using the source address as the destination address which is acquired from the packet. If the found router exit interface does not match the entrance interface acquired from this packet, the switch will consider this packet a fake packet and discard it.

In Source Address Spoofing attacks, attackers will construct a series of messages with fake source addresses. For applications based on IP address verification, such attacks may allow unauthorized users to access the system as some authorized ones, or even the administrator. Even if the response messages can't reach the attackers, they will also damage the targets.

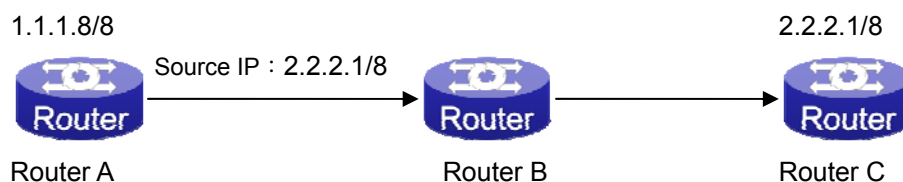

Figure 21-4-1 URPF application situation

In the above figure, Router A sends requests to the server Router B by faking messages whose source address are 2.2.2.1/8 .In response, Router B will send the messages to the real "2.2.2.1/8". Such illegal messages attack both Router B and Router C. The application of URPF technology in the situation described above can avoid the attacks based on the Source Address Spoofing.

21.4.1.1 IP URPF Operating Mechanism

At present the URPF relies on the ACL function provided by the Chassis Switch chips.

Firstly, globally enable the URPF function to monitor the changes in the router table: create a corresponding URPF permit ACL rule for each router in the router table FIB. In URPF strict mode, the format of ACL rules is: the source address segments of inbound packets + the ingress interface VID of inbound packets. The source address segments of inbound packets are in correspondence with the destination address segments in the FIB router table entries, while the ingress interface VID of inbound packets with the egress interface VID in the FIB router table entries. In URPF loose mode, the format of ACL rules is the source address segments of inbound packets, which are in correspondence with destination address segments in the FIB router table entries.

After enabling URPF on the port: bind the port to RUPF rules, and create the default hardware for DENY ALL rule distribution.

The above operations will guarantee that, when data reach the port, only those match the rules can pass through it with all others dumped.

The present corresponding ACL rule privilege is low, not blocking all kinds of protocol packets; hence, enabling this function will not affect the normal operation of routing protocols of the switch.

21.4.2 URPF Configuration Task Sequence

1. Enable URPF
2. Enable URPF on port
3. Display and debug URPF relevant information

1. Globally enable URPF

Command	Explanation
Global mode	
urpf enable no urpf enable	Globally enable and disable URPF.

2. Enable URPF on port

Command	Explanation
Port mode	
ip urpf enable {loose strict} {allow-default-route } no ip urpf enable	Enable and disable URPF on port.

3. Display and debug URPF relevant information

Command	Explanation
Admin mode	

debug l4driver urpf {notice warning error } no debug l4driver urpf {notice warning error }	Enable the URPF debug function to display error information if failures occur during the installation of URPF rules.
Admin and Config Mode	
show urpf	Display which interfaces have been enabled with URPF function.
show urpf rule ipv4 num interface ethernet IFNAME	Display the number of IPv4 rules bonded to the port.
show urpf rule ipv6 num interface ethernet IFNAME	Display the number of IPv6 rules bonded to the port.
show urpf rule ipv4 interface ethernet IFNAME	Display the details of IPv4 rules bonded to the port.
show urpf rule ipv6 interface ethernet IFNAME	Display the details of IPv6 rules bonded to the port.

21.4.3 URPF Typical Example

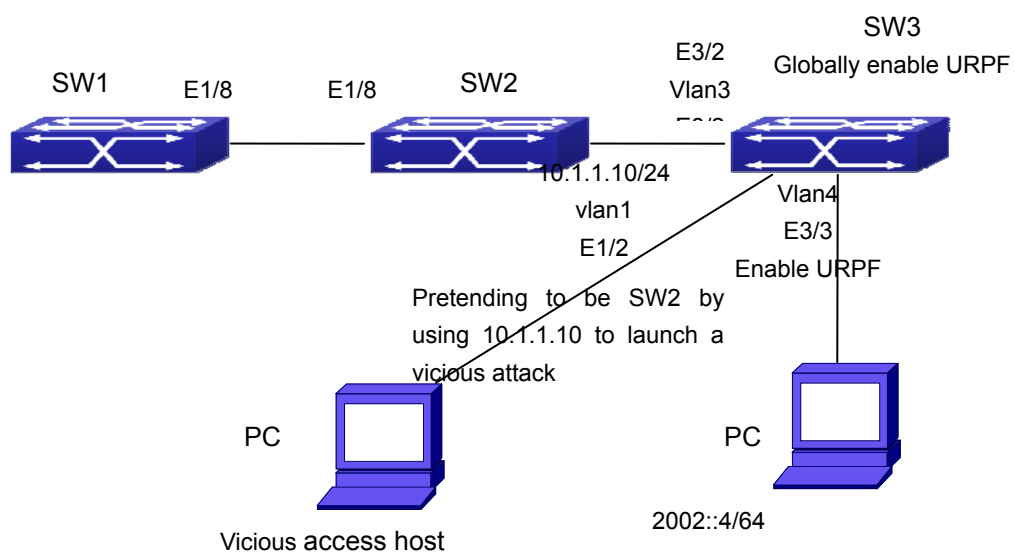

In the network, topology shown in the graph above, IP URPF function is enabled on SW3. When there is someone in the network pretending to be someone else by using his IP address to launch a vicious attack, the switch will drop all the attacking messages directly through the hardware FFP function.

Enable the URPF function in SW3 Ethernet3/3.

SW3 configuration task sequence:

```
Switch3#config
Switch3(config)#urpf enable
Switch3(config)#interface ethernet 3/3
Switch3(Config-If-Ethernet3/3)#ip urpf enable strict
```

21.4.4 URPF Troubleshooting

Proper operation of the URPF protocol depends greatly on whether the corresponding URPF rules can be applied correctly. If after the URPF configuration is done and the function does not meet the expectation:

- Check if the Chassis Switch has been configured with the rules conflicting with URPF (URPF priority is lower than ACL), the ACL rules will validate if confliction exists.
- Check whether there is a relative route in the FIB table. Only when one is found, can the ACL rules be distributed to the port.
- Check if the hardware ACL performance is full which lead to the newly generated route can not be applied with ACL rules.
- If all configurations are normal but URPF still can't operate as expected, please enable the URPF debug function and use the "show urpf" command and other commands which display the rule number and details to observe whether the created URPF rules are correct, and send the result to the technology service center.

21.5 ARP

21.5.1 Introduction to ARP

ARP (Address Resolution Protocol) is mainly used to resolve IP address to Ethernet MAC address. Chassis Switch supports both dynamic ARP and static ARP configuration. Furthermore, chassis switch supports the configuration of proxy ARP for some applications. For instance, when an ARP request is received on the port, requesting an IP address in the same IP segment of the port but not the same physical network, if the port has enabled proxy ARP, the port would reply to the ARP with its own MAC address and forward the actual packets received. Enabling proxy ARP allows machines physically separated but of the same IP segment ignores the physical separation and communicate via proxy ARP interface as if in the same physical network.

21.5.2 ARP Configuration Task List

ARP Configuration Task List:

1. Configure static ARP
2. Configure proxy ARP
3. Clear dynamic ARP
4. Select hash arithmetic
5. Clear the statistic information of ARP messages

1. Configure static ARP

Command	Explanation
VLAN Port Mode	
<code>arp <ip_address> <mac_address></code> <code>{interface [ethernet] <portName>}</code> <code>no arp <ip_address></code>	Configures a static ARP entry; the no command deletes a ARP entry of the specified IP address.

2. Configure proxy ARP

Command	Explanation
VLAN Port Mode	
ip proxy-arp no ip proxy-arp	Enables the proxy ARP function for Ethernet ports: the no command disables the proxy ARP.

3. Clear dynamic ARP

Command	Explanation
Admin mode	
clear arp-cache	The command clear arp-cache clears the content of current ARP table, but it does not clear the current static ARP table.

4. Select hash arithmetic

Command	Explanation
Global mode	
I3 hashselect [<crc16 crc16u crc32 crc32u lsb>]	Set the hash arithmetic of the layer 3 table. This command refers to ARP table list storage in the hardware, the implement need to guide by the technique specialist. The detail information please refer to the interrelated Command Guide.

5. Clear the statistic information of ARP message

Command	Explanation
Admin mode	
clear arp traffic	Clear the statistic information of ARP messages of the switch.

21.5.3 ARP Troubleshooting

If ping from the switch to directly connected network devices fails, the following can be used to check the possible cause and create a solution.

- Check whether the corresponding ARP has been learned by the Chassis Switch.
- If ARP has not been learned, then enabled ARP debugging information and view the sending/receiving condition of ARP packets.
- Defective cable is a common cause of ARP problems and may disable ARP learning.

Chapter 22 ARP Scanning Prevention Function Configuration

22.1 Introduction to ARP Scanning Prevention Function

ARP scanning is a common method of network attack. In order to detect all the active hosts in a network segment, the attack source will broadcast lots of ARP messages in the segment, which will take up a large part of the bandwidth of the network. It might even do large-traffic-attack in the network via fake ARP messages to collapse of the network by exhausting the bandwidth. Usually ARP scanning is just a preface of other more dangerous attack methods, such as automatic virus infection or the ensuing port scanning, vulnerability scanning aiming at stealing information, distorted message attack, and DOS attack, etc.

Since ARP scanning threatens the security and stability of the network with great danger, so it is very significant to prevent it. XGS3 series switch provides a complete resolution to prevent ARP scanning: if there is any host or port with ARP scanning features is found in the segment, the switch will cut off the attack source to ensure the security of the network.

There are two methods to prevent ARP scanning: port-based and IP-based. The port-based ARP scanning will count the number to ARP messages received from a port in a certain time range, if the number is larger than a preset threshold, this port will be “down”. The IP-based ARP scanning will count the number to ARP messages received from an IP in the segment in a certain time range, if the number is larger than a preset threshold, any traffic from this IP will be blocked, while the port related with this IP will not be “down”. These two methods can be enabled simultaneously. After a port or an IP is disabled, users can recover its state via automatic recovery function.

To improve the effect of the Chassis Switch, users can configure trusted ports and IP, the ARP messages from which will not be checked by the Chassis Switch. Thus the load of the switch can be effectively decreased.

22.2 ARP Scanning Prevention Configuration Task Sequence

- 1 · Enable the ARP Scanning Prevention function.
- 2 · Configure the threshold of the port-based and IP-based ARP Scanning Prevention
- 3 · Configure trusted ports
- 4 · Configure trusted IP
- 5 · Configure automatic recovery time
- 6 · Display relative information of debug information and ARP scanning

1. Enable the ARP Scanning Prevention function.

Command	Explanation
Global configuration mode	
anti-arpscan enable no anti-arpscan enable	Enable or disable the ARP Scanning Prevention function globally.

2. Configure the threshold of the port-based and IP-based ARP Scanning Prevention

Command	Explanation
Global configuration mode	
anti-arpscan port-based threshold <threshold-value> no anti-arpscan port-based threshold	Set the threshold of the port-based ARP Scanning Prevention.
anti-arpscan ip-based threshold <threshold-value> no anti-arpscan ip-based threshold	Set the threshold of the IP-based ARP Scanning Prevention.

3. Configure trusted ports

Command	Explanation
Port configuration mode	
anti-arpscan trust <port / supertrust-port> no anti-arpscan trust <port / supertrust-port>	Set the trust attributes of the ports.

4. Configure trusted IP

Command	Explanation
Global configuration mode	
anti-arpscan trust ip <ip-address> [<netmask>] no anti-arpscan trust ip <ip-address> [<netmask>]	Set the trust attributes of IP.

5. Configure automatic recovery time

Command	Explanation
Global configuration mode	
anti-arpscan recovery enable no anti-arpscan recovery enable	Enable or disable the automatic recovery function.
anti-arpscan recovery time <seconds> no anti-arpscan recovery time	Set automatic recovery time.

6. Display relative information of debug information and ARP scanning

Command	Explanation
Global configuration mode	
anti-arpscan log enable no anti-arpscan log enable	Enable or disable the log function of ARP scanning prevention.
anti-arpscan trap enable no anti-arpscan trap enable	Enable or disable the SNMP Trap function of ARP scanning prevention.
show anti-arpscan [trust <ip / port / supertrust-port> prohibited <ip / port>]	Display the state of operation and configuration of ARP scanning prevention.
Admin Mode	

```
debug anti-arpscan <port / ip>  
no debug anti-arpscan <port / ip>
```

Enable or disable the debug switch of ARP scanning prevention.

22.3 ARP Scanning Prevention Typical Examples

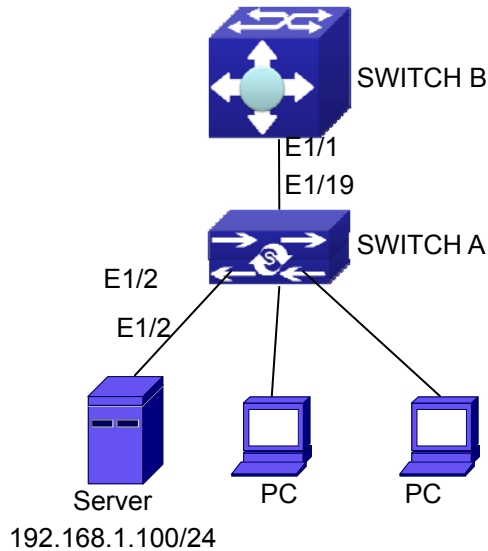

Figure 22-3-1 ARP scanning prevention typical configuration example

In the network topology above, port E1/1 of SWITCH B is connected to port E1/19 of SWITCH A, the port E1/2 of SWITCH A is connected to file server (IP address is 192.168.1.100), and all the other ports of SWITCH A are connected to common PC. The following configuration can prevent ARP scanning effectively without affecting the normal operation of the system.

SWITCH A configuration task sequence:

```
SwitchA(config)#anti-arpscan enable  
SwitchA(config)#anti-arpscan recovery time 3600  
SwitchA(config)#anti-arpscan trust ip 192.168.1.0 255.255.255.0  
SwitchA(config)#interface ethernet1/2  
SwitchA (Config-If-Ethernet1/2)#anti-arpscan trust port  
SwitchA (Config-If-Ethernet1/2)#exit  
SwitchA(config)#interface ethernet1/19  
SwitchA (Config-If-Ethernet1/19)#anti-arpscan trust supertrust-port  
Switch A(Config-If-Ethernet1/19)#exit
```

SWITCHB configuration task sequence:

```
Switch B(config)# anti-arpscan enable
SwitchB(config)#interface ethernet1/1
SwitchB (Config-If-Ethernet 1/1)#anti-arpscan trust port
SwitchB (Config-If-Ethernet 1/1)exit
```

22.4 ARP Scanning Prevention Troubleshooting Help

- ARP scanning prevention is disabled by default. After enabling ARP scanning prevention, users can enable the debug switch, “**debug anti-arpscan**”, to view debug information.

Chapter 23 Preventing ARP, ND Spoofing Configuration

23.1 Overview

23.1.1 ARP (Address Resolution Protocol)

Generally speaking, ARP (RFC-826) protocol is mainly responsible of mapping IP address to relevant 48-bit physical address, that is MAC address, for instance, IP address is 192.168.0.1, network card Mac address is 00-30-4f-FD-1D-2B. What the whole mapping process is that a host computer send broadcast data packet involving IP address information of destination host computer, ARP request, and then the destination host computer send a data packet involving its IP address and Mac address to the host, so two host computers can exchange data by MAC address.

23.1.2 ARP Spoofing

In terms of ARP Protocol design, to reduce redundant ARP data communication on networks, even though a host computer receives an ARP reply which is not requested by itself, it will also insert an entry to its ARP cache table, so it creates a possibility of “ARP spoofing”. If the hacker wants to snoop the communication between two host computers in the same network (even if are connected by the switches), it sends an ARP reply packet to two hosts separately, and make them misunderstand MAC address of the other side as the hacker host MAC address. In this way, the direct communication is actually communicated indirectly among the hacker host computer. The hackers not only obtain communication information they need, but also only need to modify some information in data packet and forward successfully. In this sniff way, the hacker host computer doesn't need to configure intermix mode of network card, that is because the data packet between two communication sides are sent to hacker host computer on physical layer, which works as a relay.

23.1.3 How to prevent ARP/ND Spoofing

There are many sniff, monitor and attack behaviors based on ARP protocol in networks, and most of attack behaviors are based on ARP spoofing, so it is very important to prevent ARP spoofing. ARP spoofing accesses normal network environment by counterfeiting legal IP address firstly, and sends a great deal of counterfeited ARP application packets to switches, after switches learn these packets, they will cover previously corrected IP, mapping of MAC address, and then some corrected IP, MAC address mapping are modified to correspondence relationship configured by attack packets so that the switch makes mistake on transfer packets, and takes an effect on the whole network. Or the switches are made used of by vicious attackers, and they intercept and capture packets transferred by switches or attack other switches, host computers or network equipment.

What the essential method on preventing attack and spoofing switches based on ARP in networks is to disable switch automatic update function; the cheater can't modify corrected MAC address in order to avoid wrong packets transfer and can't obtain other information. At one time, it doesn't interrupt the automatic

learning function of ARP. Thus it prevents ARP spoofing and attack to a great extent.

ND is neighbor discovering protocol in IPv6 protocol, and it's similar to ARP on operation principle, therefore we do in the same way as preventing ARP spoofing to prevent ND spoofing and attack.

23.2 Preventing ARP, ND Spoofing configuration

The steps of preventing ARP, ND spoofing configuration as below:

1. Disable ARP, ND automatic update function
2. Disable ARP, ND automatic learning function
3. Changing dynamic ARP, ND to static ARP, ND

1. Disable ARP, ND automatic update function

Command	Explanation
Global Mode and Port Mode	
ip arp-security updateprotect no ip arp-security updateprotect ipv6 nd-security updateprotect no ipv6 nd-security updateprotect	Disable and enable ARP, ND automatic update function.

2. Disable ARP, ND automatic learning function

Command	Explanation
Global mode and Interface Mode	
ip arp-security learnprotect no ip arp-security learnprotect ipv6 nd-security learnprotect no ipv6 nd-security learnprotect	Disable and enable ARP, ND automatic learning function.

3. Function on changing dynamic ARP, ND to static ARP, ND

Command	Explanation
Global Mode and Port Mode	
ip arp-security convert ipv6 nd-security convert	Change dynamic ARP, ND to static ARP, ND.

23.3 Preventing ARP, ND Spoofing Example

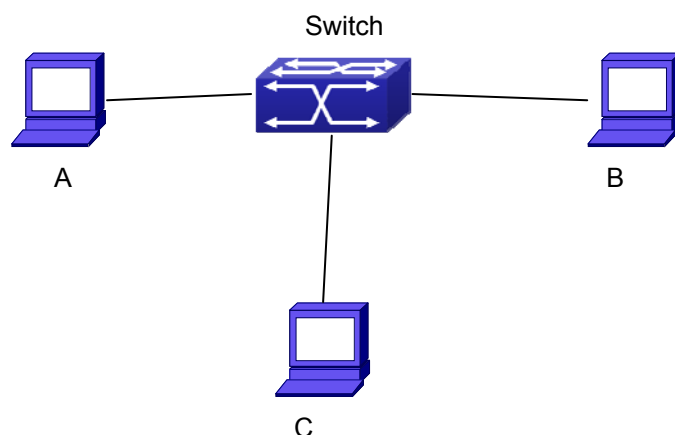

Equipment Explanation

Equipment	Configuration	Quality
switch	IP:192.168.2.4; IP:192.168.1.4; mac: 04-04-04-04-04-04	1
A	IP:192.168.2.1; mac: 01-01-01-01-01-01	1
B	IP:192.168.1.2; mac: 02-02-02-02-02-02	1
C	IP:192.168.2.3; mac: 03-03-03-03-03-03	some

There is a normal communication between B and C on above diagram. A wants switch to forward packets sent by B to itself, so need switch sends the packets transfer from B to A. firstly A sends ARP reply packet to switch, format is: 192.168.2.3, 01-01-01-01-01-01, mapping its MAC address to C's IP, so the switch changes IP address when it updates ARP list., then data packet of 192.168.2.3 is transferred to 01-01-01-01-01-01 address (A MAC address).

In further, a transfers its received packets to C by modifying source address and destination address, the mutual communicated data between B and C are received by A unconsciously. Because the ARP list is update timely, another task for A is to continuously send ARP reply packet, and refreshes switch ARP list.

So it is very important to protect ARP list, configure to forbid ARP learning command in stable environment, and then change all dynamic ARP to static ARP, the learned ARP will not be refreshed, and protect for users.

```
XGS3-42000R#config
XGS3-42000R(config)#interface vlan 1
XGS3-42000R(config-If-Vlan1)#arp 192.168.2.1 01-01-01-01-01-01 interface eth 1/2
XGS3-42000R(config-If-Vlan1)#interface vlan 2
XGS3-42000R(config-If-Vlan2)#arp 192.168.1.2 02-02-02-02-02-02 interface eth 1/2
XGS3-42000R(config-If-Vlan2)#interface vlan 3
XGS3-42000R(config-If-Vlan3)#arp 192.168.2.3 03-03-03-03-03-03 interface eth 1/2
XGS3-42000R(config-If-Vlan3)#exit
XGS3-42000R(config)#ip arp-security learnprotect
XGS3-42000R(config)#
XGS3-42000R(config)#ip arp-security convert
```

If the environment changing, it enable to forbid ARP refresh, once it learns ARP property, it wont be refreshed by new ARP reply packet, and protect use data from sniffing.

```
XGS3-42000R#config  
XGS3-42000R(config)#ip arp-security updateprotect
```

Chapter 24 ARP GUARD Configuration

24.1 Introduction to ARP GUARD

There is serious security vulnerability in the design of ARP protocol, which is any network device, can send ARP messages to advertise the mapping relationship between IP address and MAC address. This provides a chance for ARP cheating. Attackers can send ARP REQUEST messages or ARP REPLY messages to advertise a wrong mapping relationship between IP address and MAC address, causing problems in network communication. The danger of ARP cheating has two forms: 1. PC4 sends an ARP message to advertise that the IP address of PC2 is mapped to the MAC address of PC4, which will cause all the IP messages to PC2 will be sent to PC4, thus PC4 will be able to monitor and capture the messages to PC2; 2. PC4 sends ARP messages to advertise that the IP address of PC2 is mapped to an illegal MAC address, which will prevent PC2 from receiving the messages to it. Particularly, if the attacker pretends to be the gateway and do ARP cheating, the whole network will be collapsed.

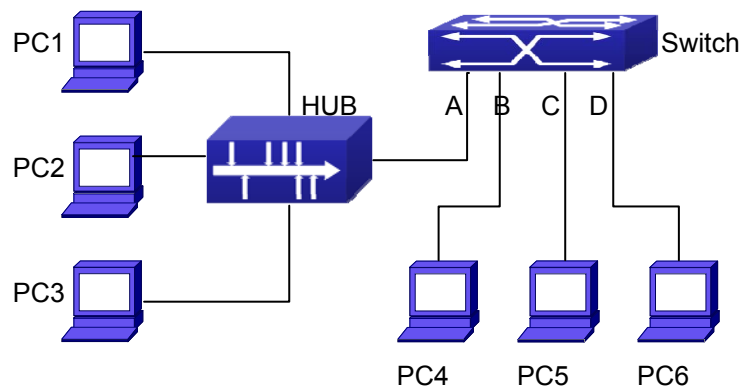

Figure 24-1-1 ARP GUARD schematic diagram

We utilize the filtering entries of the switch to protect the ARP entries of important network devices from being imitated by other devices. The basic theory of doing this is that utilizing the filtering entries of the switch to check all the ARP messages entering through the port, if the source address of the ARP message is protected, the messages will be directly dropped and will not be forwarded.

ARP GUARD function is usually used to protect the gateway from being attacked. If all the accessed PCs in the network should be protected from ARP cheating, then a large number of ARP GUARD address should be configured on the port, which will take up a big part of FFP entries in the chip, and as a result, might affect other applications. So this will be improper. It is recommended that adopting FREE RESOURCE related accessing scheme. Please refer to relative documents for details.

24.2 ARP GUARD Configuration Task List

1. Configure the protected IP address

Command	Explanation
Port configuration mode	
arp-guard ip <addr> no arp-guard ip <addr>	Configure/delete ARP GUARD address

Chapter 25 ARP Local Proxy Configuration

25.1 Introduction to ARP Local Proxy function

In a real application environment, the switches in the aggregation layer are required to implement local ARP proxy function to avoid ARP cheating. This function will restrict the forwarding of ARP messages in the same vlan and thus direct the L3 forwarding of the data flow through the switch.

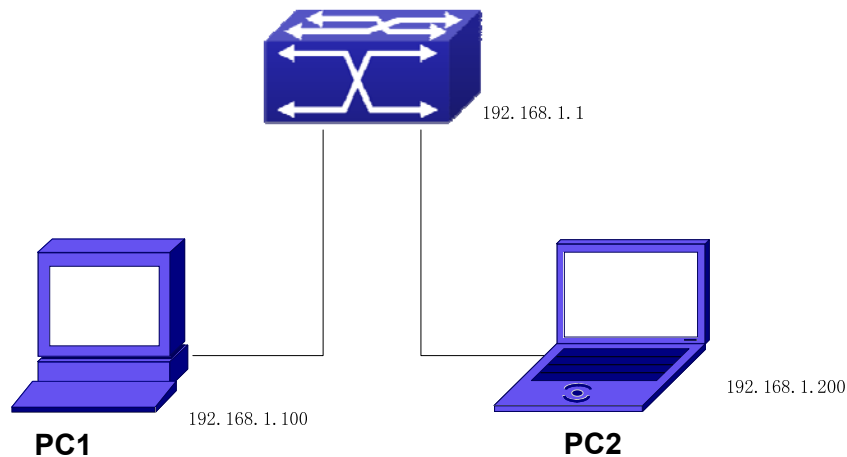

As shown in the figure above, PC1 wants to send an IP message to PC2, the overall procedure goes as follows (some non-arp details are ignored)

1. Since PC1 does not have the ARP of PC2, it sends and broadcasts ARP request.
2. Receiving the ARP message, the switch hardware will send the ARP request to CPU instead of forwarding this message via hardware, according to new ARP handling rules.
3. With local ARP proxy enabled, the switch will send ARP reply message to PC1 (to fill up its mac address)
4. After receiving the ARP reply, PC1 will create ARP, send an IP message, and set the destination MAC of the Ethernet head as the MAC of the switch.
5. After receiving the ip message, the switch will search the router table (to create router cache) and distribute hardware entries.
6. If the switch has the ARP of PC2, it will directly encapsulate the Ethernet head and send the message (the destination MAC is that of PC2)
7. If the switch does not have the ARP of PC2, it will request it and then send the ip message.

This function should cooperate with other security functions. When users configure local ARP proxy on an aggregation switch while configuring interface isolation function on the layer-2 switch connected to it, all ip flow will be forwarded on layer 3 via the aggregation switch. And due to the interface isolation, ARP messages will not be forwarded within the vlan, which means other PCs will not receive it.

25.2 ARP Local Proxy Function Configuration Task List

1 · Enable/disable ARP local proxy function

Command	Explanation
Interface VLAN mode	
ip local proxy-arp no ip local proxy-arp	Enable or disable ARP local proxy function.

25.3 Typical Examples of ARP Local Proxy Function

As shown in the following figure, S1 is a medium/high-level layer-3 switch supporting ARP local proxy, S2 is layer-2 access switches supporting interface isolation.

Considering security, interface isolation function is enabled on S2. Thus all downlink ports of S2 is isolated from each other, making all ARP messages able to be forwarded through S1. if ARP local proxy is enabled on S1, then all interfaces on S1 isolate ARP while S1 serves as an ARP proxy. As a result, IP flow will be forwarded at layer 3 through S1 instead of S2.

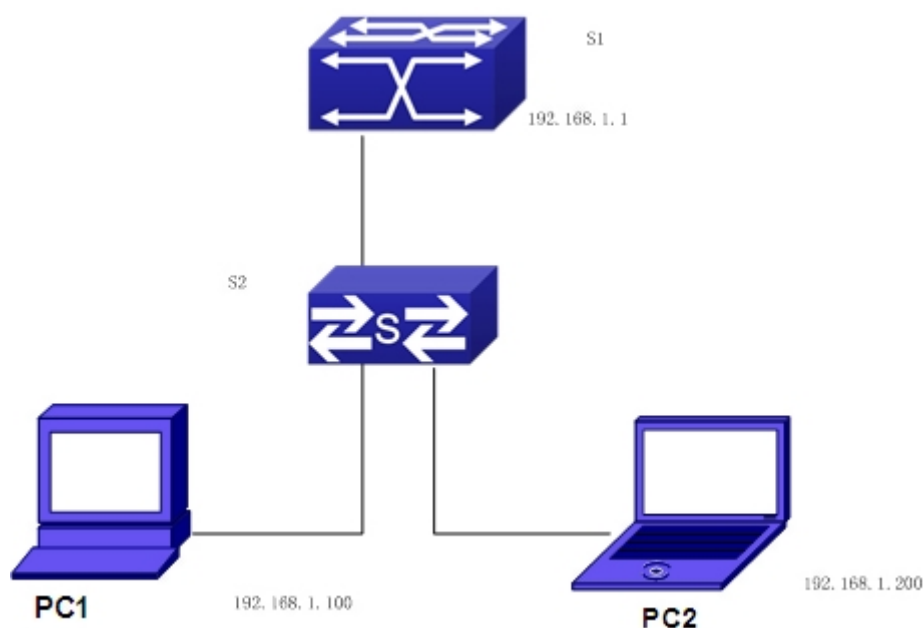

We can configure as follows:

```
XGS3-42000R(config)#interface vlan 1
XGS3-42000R(config-if-Vlan1)#ip address 192.168.1.1 255.255.255.0
XGS3-42000R(config-if-Vlan1)#ip local proxy-arp
XGS3-42000R(config-if-Vlan1)#exit
```

25.4 ARP Local Proxy Function Troubleshooting

ARP local proxy function is disabled by default. Users can view the current configuration with display command. With correct configuration, by enabling debug of ARP, users can check whether the ARP proxy is normal and send proxy ARP messages.

In the process of operation, the system will show corresponding prompts if any operational error occurs.

Chapter 26 Gratuitous ARP Configuration

26.1 Introduction to Gratuitous ARP

Gratuitous ARP is a kind of ARP request that is sent by the host with its IP address as the destination of the ARP request.

The basic working mode for XGS3 Chassis Switches is as below: The Layer 3 interfaces of the Chassis Switch can be configured to advertise gratuitous ARP packets period or the Chassis Switch can be configured to enable to send gratuitous ARP packets in all the interfaces globally.

The purpose of gratuitous ARP is as below:

1. To reduce the frequency that the host sends ARP request to the switch. The hosts in the network will periodically send ARP requests to the gateway to update the MAC address of the gateway. If the switch advertises gratuitous ARP requests, the host will not have to send these requests. This will reduce the frequency the hosts' sending ARP requests for the gateway's MAC address.
2. Gratuitous ARP is a method to prevent ARP cheating. The switch's advertising gratuitous ARP request will force the hosts to update its ARP table cache. Thus, forged ARP of gateway cannot function.

26.2 Gratuitous ARP Configuration Task List

- 1 · Enable gratuitous ARP and configure the interval to send gratuitous ARP request
- 2 · Display configurations about gratuitous ARP

1. Enable gratuitous ARP and configure the interval to send gratuitous ARP request.

Command	Explanation
Global Configuration Mode and Interface Configuration Mode.	
ip gratuitous-arp <5-1200> no ip gratuitous-arp	To enable gratuitous ARP and configure the interval to send gratuitous ARP request. The no command cancels the gratuitous ARP.

2. Display configurations about gratuitous ARP

Command	Explanation
Admin Mode and Configuration Mode	
show ip gratuitous-arp [interface vlan <1-4094>]	To display configurations about gratuitous ARP.

26.3 Gratuitous ARP Configuration Example

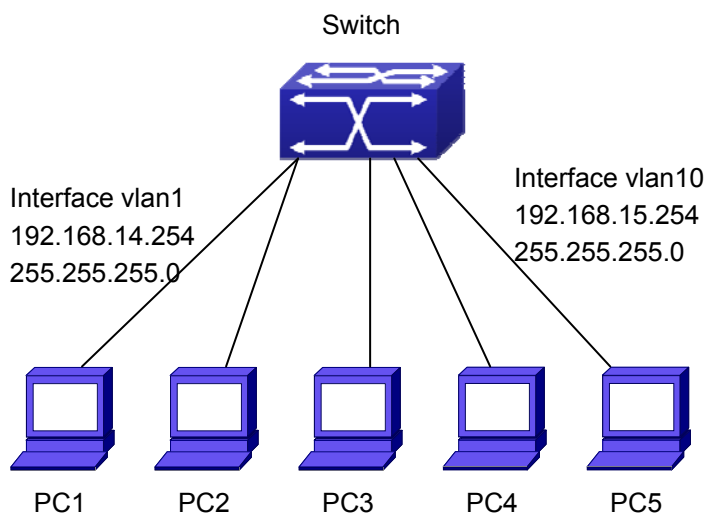

Figure 26-3-1 Gratuitous ARP Configuration Example

For the network topology shown in the figure above, interface VLAN10 whose IP address is 192.168.15.254 and network address mask is 255.255.255.0 in the switch system. Three PCs – PC3, PC4, PC5 are connected to the interface. The IP address of interface VLAN 1 is 192.168.14.254, its network address mask is 255.255.255.0. Two PCs – PC1 and PC2 are connected to this interface. Gratuitous ARP can be enabled through the following configuration:

1. Configure two interfaces to use gratuitous ARP at one time.

```
XGS3-42000R(config)#ip gratuitous-arp 300
XGS3-42000R(config)#exit
```

2. Configure gratuitous ARP specifically for only one interface at one time.

```
XGS3-42000R(config)#interface vlan 10
XGS3-42000R(conFIG-if-VLAN10)#ip gratuitous-arp 300
XGS3-42000R(conFIG-if-VLAN10)#exit
XGS3-42000R(config) #exit
```

26.4 Gratuitous ARP Troubleshooting

Gratuitous ARP is disabled by default. And when gratuitous ARP is enabled, the debugging information about ARP packets can be retrieved through the command `debug arp send`.

If gratuitous ARP is enabled in global configuration mode, it can be disabled only in global configuration mode. If gratuitous ARP is configured in interface configuration mode, the configuration can only be disabled in interface configuration mode.

Chapter 27 ND Snooping Configuration

27.1 Introduction to ND Snooping

The purpose of developing ND snooping module: using Control Packet Snooping (CPS) mechanism, that means to detect the validity of access packets through the method which bind the source IPv6 address and the anchor information, so as to permit the matched packets and drop the unmatched packets that will control access of the direct connected IPv6 nodes. The development of this module requirement refers to IPv6 NDP and 《Control Packet Snooping Based Binding draft-bi-savi-cps-00》 draft. ND snooping adopts the “first-come first-serve” of the 《First-Come First-Serve Source-Address Validation Implementation draft-ietf-savi-fcfs-01》 draft that means to set up the first bound nodes as the legality nodes, and it is a principle to check the validity of the nodes.

ND snooping is mostly applied to the access device (such as layer 2 switch, wireless access node). The access device creates the binding information table of link-local nodes (the binding refers to the IPv6 address and the port ID and the MAC address of the nodes) according to the NDP packets received from these ports, then creates the rules of FFP (Fast Filter Processor) hardware drive according to the binding information table, and implements the access control of the link-local nodes.

27.2 ND Snooping Basic Configuration

ND Snooping Configuration Task List:

1. Enable or disable the monitor function of ND Snooping
2. Configure the lifetime of ND Snooping
 - 1) Set the binding lifetime of SAC_BOUND state
 - 2) Set the binding lifetime of SAC_START state
 - 3) Set the binding lifetime of SAC-QUERY state
3. The binding function of ND Snooping
 - 1) Configure the dynamic binding policy of ND Snooping address
 - 2) Add a static binding
 - 3) Configure the max number of IPv6 addresses that can be bound to the same MAC address
 - 4) Set the max binding number for the ports
 - 5) Clear all dynamic bindings of ND Snooping
4. Set the trust port of the switch

1. Enable or disable the monitor function of ND Snooping

Command	Expalnation
Global mode	
ipv6 nd snooping enable no ipv6 nd snooping enable	Enable or disable ND Snooping globally.
Port mode	

ipv6 nd snooping user-control no ipv6 nd snooping user-control	Enable or disable ND Snooping in a port.
---	--

2. Configure the lifetime of ND Snooping Command	Explanation
Global mode	
[no] ipv6 nd snooping max-sac-lifetime <max-sac-lifetime>	Reset the binding lifetime as <max-sac-lifetime> or 2 hours for SAC_BOUND.
[no] ipv6 nd snooping max-dad-delay <max-dad-delay>	Reset the binding lifetime as <max-dad-delay> or 1 second for SAC_START.
[no] ipv6 nd snooping max-dad-prepare-delay <max-dad-prepare-delay>	Reset the binding lifetime as <max-dad-prepare-delay> half a second for SAC_QUERY.

3. The binding function of ND Snooping

Command	Explanation
Global mode	
[no] ipv6 nd snooping policy {bind-eui64-address bind-non-eui64-address}	Configure the dynamic binding policy of ND Snooping address.
ipv6 nd snooping static-binding <ipv6-address> hardware-address <hardware-address> interface <interface-name> no ipv6 nd snooping static-binding <ipv6-address>	Add a static binding.
ipv6 nd snooping mac-binding-limit <number> no ipv6 nd snooping mac-binding-limit	Configure the max number of IPv6 addresses that can be bound to the same MAC address.
Port mode	
ipv6 nd snooping port-binding-limit <binding-number> no ipv6 nd snooping port-binding-limit	Set the binding number for the ports. The binding number only limits the dynamic binding number of the ports, do not limit the static binding number of the ports.
Admin mode	
clear ipv6 nd snooping binding [<interface-name>]	Clear all static binding of ND Snooping.

4. Set the trust port of the switch

Command	Explanation
Global mode	
ipv6 nd snooping trust no ipv6 nd snooping trust	Set the trust port of the switch.

27.3 ND Snooping Example

Typical example:

The application environment of ND Snooping, the figure is as follows:

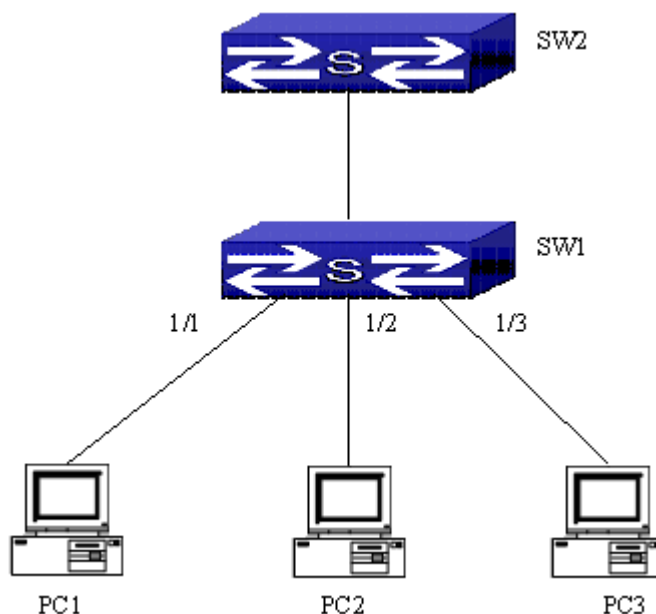

Figure 27-3-1 ND Snooping typical configuration

The configuration explanation:

SW2 is layer 3 switch, it connect to the layer 2 switch SW1, and enable IPv6 function and RA function;

SW1 is layer 2 switch, it enables IPv6 function and ND Snooping, and enable the control function of ND snooping on the ports which connect three PC nodes.

PC1, PC2, PC3 are three PCs, each PC installed IPv6 protocol and directly connect SW1, the direct ports are 1/1, 1/2, 1/3. Layer 2 switch SW1 enabled ND Snooping. PC1, PC2 and PC3 correctly receive RA router advertisement packets from SW2. According to the link prefix 2001::/64 of RA packets, three PCs create IPv6 addresses automatically, they are:

PC1: FE80::2AA:FF:FE9A:4CA2, 2001::2AA:FF:FE9A:4CA2, 2001::23:4A:1122:C411;

PC2: FE80::2BB:FF:FE9A:4CA2, 2001::2BB:FF:FE9A:4CA2, 2001::32:4B:2211:11C4;

PC3: FE80::2CC:FF:FE9A:4CA2, 2001::2CC:FF:FE9A:4CA2, 2001::22:4A:1133:C422;

At the same time, three PCs send the DAD (duplicate address detect) NS packets to the link-local, ND Snooping module receives DAD NS packets and set up the corresponding dynamic binding table according to these packets , the table is as follows:

IPv6 address	MAC address	Port ID
FE80::2AA:FF:FE9A:4CA2	02-AA-00-9A-4C-A2	1/1
2001::2AA:FF:FE9A:4CA2	02-AA-00-9A-4C-A2	1/1
2001::23:4A:1122:C411	02-AA-00-9A-4C-A2	1/1
FE80:: BB:FF:FE9A:4CA2	02-BB-00-9A-4C-A2	1/2
2001::2BB:FF:FE9A:4CA2	02-BB-00-9A-4C-A2	1/2
2001::32:4B:2211:11C4	02-BB-00-9A-4C-A2	1/2
FE80:: CC:FF:FE9A:4CA2	02-CC-00-9A-4C-A2	1/3
2001::2CC:FF:FE9A:4CA2	02-CC-00-9A-4C-A2	1/3
2001::22:4A:1133:C422	02-CC-00-9A-4C-A2	1/3

If three PCs do not receive the responding DAD NA packets in the set time, then port 1/1, port 1/2, port 1/3 send to the FFP hardware drive binding entries according to the dynamic binding table. After that, these port will detect the source addresses of the received data packet, if it match the binding entries, then the IPv6 packet are allowed to pass, otherwise, the IPv6 packet are denied.

Configuration steps:

SW1:

```
SW1(config)# ipv6 enable
SW1(config)# ipv6 nd snooping enable
SW1(config)# interface vlan 1
SW1(config-if-vlan1)# ipv6 address 2001::1/64
SW1(config)# interface ethernet 1/1; 1/2; 1/3
SW1(config-if-port-range)# ipv6 nd snooping user-control
```

SW2:

```
SW2(config)# ipv6 enable
SW2(config)# interface vlan 1
SW2(config-if-vlan1)# ipv6 address 2001::2/64
SW2(config-if-vlan1)# no ipv6 nd suppress-ra
```

27.4 ND Snooping Troubleshooting

If there is any problem happening when using ND Snooping, please check whether the problem is caused by the following reasons:

- Whether ipv6 nd snooping enable is enabled globally and ipv6 nd snooping user-control is configured in the port.
- Use debug ipv6 nd snooping to check whether the switch can correctly receive and process the relative packets.

Chapter 28 DHCP Configuration

28.1 Introduction to DHCP

DHCP [RFC2131] is the acronym for Dynamic Host Configuration Protocol. It is a protocol that assigns IP address dynamically from the address pool as well as other network configuration parameters such as default gateway, DNS server, and default route and host image file position within the network. DHCP is the enhanced version of BOOTP. It is a mainstream technology that can not only provide boot information for diskless workstations, but can also release the administrators from manual recording of IP allocation and reduce user effort and cost on configuration. Another benefit of DHCP is it can partially ease the pressure on IP demands, when the user of an IP leaves the network that IP can be assigned to another user.

DHCP is a client-server protocol, the DHCP client requests the network address and configuration parameters from the DHCP server; the server provides the network address and configuration parameters for the clients; if DHCP server and clients are located in different subnets, DHCP relay is required for DHCP packets to be transferred between the DHCP client and DHCP server. The implementation of DHCP is shown below:

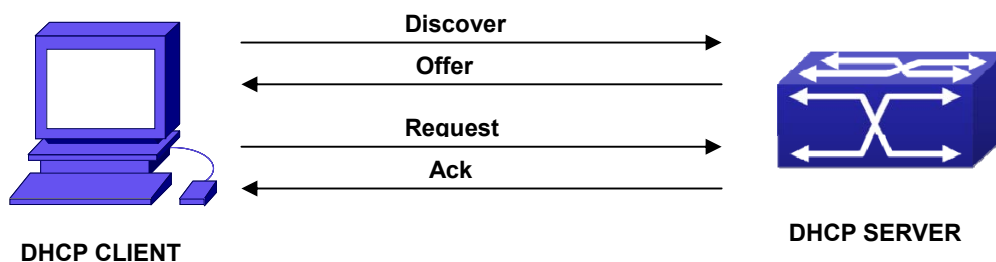

Figure 28-1-1 DHCP protocol interaction

Explanation:

- 1 · DHCP client broadcasts DHCPDISCOVER packets in the local subnet.
- 2 · On receiving the DHCPDISCOVER packet, DHCP server sends a DHCPOFFER packet along with IP address and other network parameters to the DHCP client.
- 3 · DHCP client broadcast DHCPREQUEST packet with the information for the DHCP server it selected after selecting from the DHCPOFFER packets.
- 4 · The DHCP server selected by the client sends a DHCPACK packet and the client gets an IP address and other network configuration parameters.

The above four steps finish a Dynamic host configuration assignment process. However, if the DHCP server and the DHCP client are not in the same network, the server will not receive the DHCP broadcast packets sent by the client, therefore no DHCP packets will be sent to the client by the server. In this case, a DHCP relay is required to forward such DHCP packets so that the DHCP packets exchange can be completed between the DHCP client and server.

Switch can act as both a DHCP server and a DHCP relay. DHCP server supports not only dynamic IP address assignment, but also manual IP address binding (i.e. specify a specific IP address to a specified MAC address or specified device ID over a long period. The differences and relations between dynamic IP address allocation and manual IP address binding are: 1) IP address obtained dynamically can be different every time;

manually bound IP address will be the same all the time. 2) The lease period of IP address obtained dynamically is the same as the lease period of the address pool, and is limited; the lease of manually bound IP address is theoretically endless. 3) Dynamically allocated address cannot be bound manually. 4) Dynamic DHCP address pool can inherit the network configuration parameters of the dynamic DHCP address pool of the related segment.

28.2 DHCP Server Configuration

DHCP Server Configuration Task List:

1. Enable/Disable DHCP server
2. Configure DHCP Address pool
 - (1) Create/Delete DHCP Address pool
 - (2) Configure DHCP address pool parameters
 - (3) Configure manual DHCP address pool parameters
3. Enable logging for address conflicts

1. Enable/Disable DHCP server

Command	Explanation
Global Mode	
service dhcp no service dhcp	Enable DHCP server. The no command disables DHCP server.

2. Configure DHCP Address pool

(1) Create/Delete DHCP Address pool

Command	Explanation
Global Mode	
ip dhcp pool <name> no ip dhcp pool <name>	Configure DHCP Address pool. The no operation cancels the DHCP Address pool.

(2) Configure DHCP address pool parameters

Command	Explanation
DHCP Address Pool Mode	
network-address <network-number> [mask prefix-length] no network-address	Configure the address scope that can be allocated to the address pool. The no operation of this command cancels the allocation address pool.
default-router [<address1>[<address2>[...<address8>]]] no default-router	Configure default gateway for DHCP clients. The no operation cancels the default gateway.
dns-server [<address1>[<address2>[...<address8>]]] no dns-server	Configure DNS server for DHCP clients. The no command deletes DNS server configuration.

domain-name <domain> no domain-name	Configure Domain name for DHCP clients; the “ no domain-name ” command deletes the domain name.
netbios-name-server [<address1>[<address2>[...<address8>]]] no netbios-name-server	Configure the address for WINS server. The no operation cancels the address for server.
netbios-node-type {b-node h-node m-node p-node <type-number>} no netbios-node-type	Configure node type for DHCP clients. The no operation cancels the node type for DHCP clients.
bootfile <filename> no bootfile	Configure the file to be imported for DHCP clients on boot up. The no command cancels this operation.
next-server [<address1>[<address2>[...<address8>]]] no next-server [<address1>[<address2>[...<address8>]]]	Configure the address of the server hosting file for importing. The no command deletes the address of the server hosting file for importing.
option <code> {ascii <string> hex <hex> ipaddress <ipaddress>} no option <code>	Configure the network parameter specified by the option code. The no command deletes the network parameter specified by the option code.
lease { days [hours][minutes] infinite } no lease	Configure the lease period allocated to addresses in the address pool. The no command deletes the lease period allocated to addresses in the address pool.
Global Mode	
ip dhcp excluded-address <low-address> [<high-address>] no ip dhcp excluded-address <low-address> [<high-address>]	Exclude the addresses in the address pool that are not for dynamic allocation.

(3) Configure manual DHCP address pool parameters

Command	Explanation
DHCP Address Pool Mode	
hardware-address <hardware-address> [{Ethernet IEEE802 <type-number>}] no hardware-address	Specify/delete the hardware address when assigning address manually.
host <address> [<mask> / <prefix-length>] no host	Specify/delete the IP address to be assigned to the specified client when binding address manually.
client-identifier <unique-identifier> no client-identifier	Specify/delete the unique ID of the user when binding address manually.

client-name <name>	Configure/delete a client name when
no client-name	binding address manually.

3. Enable logging for address conflicts

Command	Explanation
Global Mode	
ip dhcp conflict logging	Enable/disable logging for DHCP address to detect address conflicts.
no ip dhcp conflict logging	
Admin Mode	
clear ip dhcp conflict <address / all >	Delete a single address conflict record or all conflict records.

28.3 DHCP Relay Configuration

When the DHCP client and server are in different segments, DHCP relay is required to transfer DHCP packets. Adding a DHCP relay makes it unnecessary to configure a DHCP server for each segment, one DHCP server can provide the network configuration parameter for clients from multiple segments, which is not only cost-effective but also management-effective.

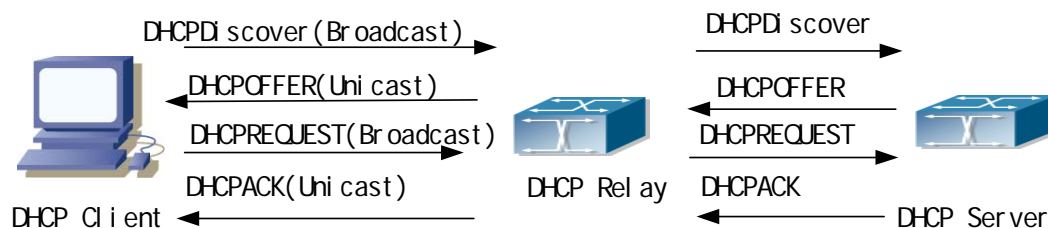

Figure 28-3-1 DHCP relay

As shown in the above figure, the DHCP client and the DHCP server are in different networks, the DHCP client performs the four DHCP steps as usual yet DHCP relay is added to the process.

1. The client broadcasts a DHCPDISCOVER packet, and DHCP relay inserts its own IP address to the relay agent field in the DHCPDISCOVER packet on receiving the packet, and forwards the packet to the specified DHCP server (for DHCP frame format, please refer to RFC2131).
2. On the receiving the DHCPDISCOVER packets forwarded by DHCP relay, the DHCP server sends the DHCPOFFER packet via DHCP relay to the DHCP client.
3. DHCP client chooses a DHCP server and broadcasts a DHCPREQUEST packet, DHCP relay forwards the packet to the DHCP server after processing.
4. On receiving DHCPREQUEST, the DHCP server responds with a DHCPACK packet via DHCP relay to the DHCP client.

DHCP Relay Configuration Task List:

1. Enable DHCP relay.
2. Configure DHCP relay to forward DHCP broadcast packet.

1. Enable DHCP relay.

Command	Explanation
Global Mode	
service dhcp no service dhcp	DHCP server and DHCP relay is enabled as the DHCP service is enabled.

2. Configure DHCP relay to forward DHCP broadcast packet.

Command	Explanation
Global Mode	
ip forward-protocol udp bootps no ip forward-protocol udp bootps	The UDP port 67 is used for DHCP broadcast packet forwarding.
Interface Configuration Mode	
ip helper-address <ipaddress> no ip helper-address <ipaddress>	Set the destination IP address for DHCP relay forwarding; the “ no ip helper-address <ipaddress> ” command cancels the setting.

28.4 DHCP Configuration Examples

Scenario 1:

To save configuration efforts of network administrators and users, a company is using switch as a DHCP server. The Admin VLAN IP address is 10.16.1.2/16. The local area network for the company is divided into network A and B according to the office locations. The network configurations for location A and B are shown below.

PoolA(network 10.16.1.0)		PoolB(network 10.16.2.0)	
Device	IP address	Device	IP address
Default gateway	10.16.1.200 10.16.1.201	Default gateway	10.16.1.200 10.16.1.201
DNS server	10.16.1.202	DNS server	10.16.1.202
WINS server	10.16.1.209	WWW server	10.16.1.209
WINS node type	H-node		
Lease	3 days	Lease	1day

In location A, a machine with MAC address 00-03-22-23-dc-ab is assigned with a fixed IP address of 10.16.1.210 and named as “management”.

```
XGS3-42000R(config)#interface vlan 1
XGS3-42000R(config-Vlan-1)#ip address 10.16.1.2 255.255.0.0
XGS3-42000R(config-Vlan-1)#exit
XGS3-42000R(config)#ip dhcp pool A
XGS3-42000R (dhcp-A-config)#network 10.16.1.0 24
XGS3-42000R (dhcp-A-config)#lease 3
XGS3-42000R (dhcp-A-config)#default-route 10.16.1.200 10.16.1.201
XGS3-42000R (dhcp-A-config)#dns-server 10.16.1.202
XGS3-42000R (dhcp-A-config)#netbios-name-server 10.16.1.209
```

```

XGS3-42000R (dhcp-A-config)#netbios-node-type H-node
XGS3-42000R (dhcp-A-config)#exit
XGS3-42000R(config)#ip dhcp excluded-address 10.16.1.200 10.16.1.201
XGS3-42000R(config)#ip dhcp pool B
XGS3-42000R (dhcp-B-config)#network 10.16.2.0 24
XGS3-42000R (dhcp-B-config)#lease 1
XGS3-42000R (dhcp-B-config)#default-route 10.16.2.200 10.16.2.201
XGS3-42000R (dhcp-B-config)#dns-server 10.16.2.202
XGS3-42000R (dhcp-B-config)#option 72 ip 10.16.2.209
XGS3-42000R (dhcp-config)#exit
XGS3-42000R(config)#ip dhcp excluded-address 10.16.2.200 10.16.2.201
XGS3-42000R(config)#ip dhcp pool A1
XGS3-42000R (dhcp-A1-config)#host 10.16.1.210
XGS3-42000R (dhcp-A1-config)#hardware-address 00-03-22-23-dc-ab
XGS3-42000R (dhcp-A1-config)#client-name management
XGS3-42000R (dhcp-A1-config)#exit

```

Usage Guide: When a DHCP/BOOTP client is connected to a VLAN1 port of the switch, the client can only get its address from 10.16.1.0/24 instead of 10.16.2.0/24. This is because the broadcast packet from the client will be requesting the IP address in the same segment of the VLAN interface after VLAN interface forwarding, and the VLAN interface IP address is 10.16.1.2/24, therefore the IP address assigned to the client will belong to 10.16.1.0/24.

If the DHCP/BOOTP client wants to have an address in 10.16.2.0/24, the gateway forwarding broadcast packets of the client must belong to 10.16.2.0/24. The connectivity between the client gateway and the switch must be ensured for the client to get an IP address from the 10.16.2.0/24 address pool.

Scenario 2:

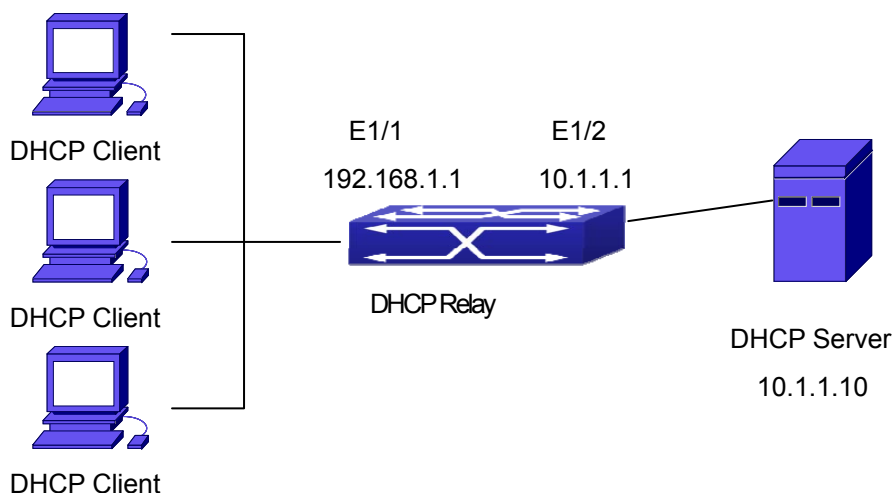

Figure 28-4-1 DHCP Relay Configuration

As shown in the above figure, route switch is configured as a DHCP relay. The DHCP server address is 10.1.1.10, TFTP server address is 10.1.1.20, the configuration steps is as follows:

```
XGS3-42000R(config)#interface vlan 1
XGS3-42000R(config-if-Vlan1)#ip address 192.168.1.1 255.255.255.0
XGS3-42000R(config-if-Vlan1)#exit
XGS3-42000R(config)#vlan 2
XGS3-42000R(config-Vlan-2)#exit
XGS3-42000R(config)#interface Ethernet 1/2
XGS3-42000R(config-Ethernet1/2)#switchport access vlan 2
XGS3-42000R(config-Ethernet1/2)#exit
XGS3-42000R(config)#interface vlan 2
XGS3-42000R(config-if-Vlan2)#ip address 10.1.1.1 255.255.255.0
XGS3-42000R(config-if-Vlan2)#exit
XGS3-42000R(config)#ip forward-protocol udp bootps
XGS3-42000R(config)#interface vlan 1
XGS3-42000R(config-if-Vlan1)#ip help-address 10.1.1.10
XGS3-42000R(config-if-Vlan1)#exit
```



It is recommended to use the combination of command **ip forward-protocol udp <port>** and **ip helper-address <ipaddress>**. **ip help-address** can only be configured for ports on layer 3 and cannot be configured on layer 2 ports directly.

28.5 DHCP Troubleshooting

If the DHCP clients cannot obtain IP addresses and other network parameters, the following procedures can be followed when DHCP client hardware and cables have been verified ok.

- Verify the DHCP server is running, start the related DHCP server if not running. If the DHCP clients and servers are not in the same physical network, verify the router responsible for DHCP packet forwarding has DHCP relay function. If DHCP relay is not available for the intermediate router, it is recommended to replace the router or upgrade its software to one that has a DHCP relay function.
- In such case, DHCP server should be examined for an address pool that is in the same segment of the switch VLAN, such a pool should be added if not present, and (This does not indicate switch cannot assign IP address for different segments, see solution 2 for details.)
- In DHCP service, pools for dynamic IP allocation and manual binding are conflicting, i.e., if command “**network-address**” and “**host**” are run for a pool, only one of them will take effect; furthermore, in manual binding, only one IP-MAC binding can be configured in one pool. If multiple bindings are required, multiple manual pools can be created and IP-MAC bindings set for each pool. New configuration in the same pool overwrites the previous configuration.

Chapter 29 DHCPv6 Configuration

29.1 Introduction to DHCPv6

DHCPv6 [RFC3315] is the IPv6 version for **Dynamic Host Configuration Protocol (DHCP)**. It is a protocol that assigns IPv6 address as well as other network configuration parameters such as DNS address, and domain name to DHCPv6 client, DHCPv6 is a conditional auto address configuration protocol relative to IPv6. In the conditional address configuration process, DHCPv6 server assigns a complete IPv6 address to client, and provides DNS address, domain name and other configuration information, maybe the DHCPv6 packet can transmit through relay delegation, at last the binding of IPv6 address and client can be recorded by DHCPv6 server, all that can enhance the management of network; DHCPv6 server can also provide non state DHCPv6 service, that is only assigns DNS address and domain name and other configuration information but not assigns IPv6 address, it can solve the bug of IPv6 auto address configuration in non state; DHCPv6 can provide extend function of DHCPv6 prefix delegation, upstream route can assign address prefix to downstream route automatically, that achieve the IPv6 address auto assignment in levels of network environment, and resolved the problem of ISP and IPv6 network dispose.

There are three entities in the DHCPv6 protocol – the client, the relay and the server. The DHCPv6 protocol is based on the UDP protocol. The DHCPv6 client sends request messages to the DHCP server or DHCP relay with the destination port as 547, and the DHCPv6 server and relay send replying messages with the destination port as 546. The DHCPv6 client sends solicit or request messages with the multicast address – ff02::1:2 for DHCP relay and server.

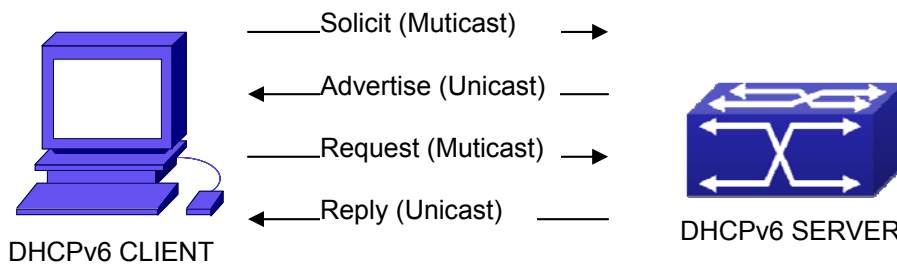

Figure 29-1-1 DHCPv6 negotiation

When a DHCPv6 client tries to request an IPv6 address and other configurations from the DHCPv6 server, the client has to find the location of the DHCP server, and then request configurations from the DHCP server.

1. In the time of located server, the DHCP client tries to find a DHCPv6 server by broadcasting a SOLICIT packet to all the DHCP relay delegation and server with broadcast address as FF02::1:2.
2. Any DHCP server which receives the request, will reply the client with an ADVERTISE message, which includes the identity of the server –DUID, and its priority.
3. It is possible that the client receives multiple ADVERTISE messages. The client should select one and reply it with a REQUEST message to request the address which is advertised in the ADVERTISE message.
4. The selected DHCPv6 server then confirms the client about the IPv6 address and any other configuration with the REPLY message.

The above four steps finish a Dynamic host configuration assignment process. However, if the DHCPv6 server and the DHCPv6 client are not in the same network, the server will not receive the DHCPv6 broadcast packets sent by the client, therefore no DHCPv6 packets will be sent to the client by the server. In this case, a DHCPv6 relay is required to forward such DHCPv6 packets so that the DHCPv6 packets exchange can be completed between the DHCPv6 client and server.

At the time this manual is written, DHCPv6 server, relay and prefix delegation client have been implemented on the switch. When the DHCPv6 relay receives any messages from the DHCPv6 client, it will encapsulate the request in a Relay-forward packet and deliver it to the next DHCPv6 relay or the DHCPv6 server. The DHCPv6 messages coming from the server will be encapsulated as relay reply packets to the DHCPv6 relay. The relay then removes the encapsulation and delivers it the DHCPv6 client or the next DHCPv6 relay in the network.

For DHCPv6 prefix delegation where DHCPv6 server is configured on the PE router and DHCPv6 client it configured on the CPE router, the CPE router is able to send address prefix allocation request to the PE router and get a pre-configured address prefix, but not set the address prefix manually. The protocol negotiation between the client and the prefix delegation client is quite similar to that when getting a DHCPv6 address. Then the CPE router divides the allocated prefix – whose length should be less than 64 characters, into 64 subnets. The divided address prefix will be advertised through routing advertisement messages (RA) to the host directly connected to the client.

29.2 DHCPv6 Server Configuration

DHCPv6 server configuration task list as below:

1. To enable/disable DHCPv6 service
2. To configure DHCPv6 address pool
 - (1) To achieve/delete DHCPv6 address pool
 - (2) To configure parameter of DHCPv6 address pool
3. To enable DHCPv6 server function on port

1. To enable/disable DHCPv6 service

Command	Explanation
Global Mode	
service dhcpv6 no service dhcpv6	To enable DHCPv6 service.

2. To configure DHCPv6 address pool

- (1) To achieve/delete DHCPv6 address pool

Command	Explanation
Global Mode	
ipv6 dhcp pool <poolname> no ipv6 dhcp pool <poolname>	To configure DHCPv6 address pool.

(2) To configure parameter of DHCPv6 address pool

Command	Explanation
DHCPv6 address pool Configuration Mode	
network-address <i><ipv6-pool-start-address></i> { <i><ipv6-pool-end-address></i> <i><prefix-length></i> } [eui-64] no network-address	To configure the range of IPv6 address assignable of address pool.
dns-server <i><ipv6-address></i> no dns-server <i><ipv6-address></i>	To configure DNS server address for DHCPv6 client.
domain-name <i><domain-name></i> no domain-name <i><domain-name></i>	To configure DHCPv6 client domain name.
excluded-address <i><ipv6-address></i> no excluded-address <i><ipv6-address></i>	To exclude IPv6 address which isn't used for dynamic assignment in address pool.
lifetime { <i><valid-time></i> infinity} { <i><preferred-time></i> infinity} no lifetime	To configure valid time or preferred time of DHCPv6 address pool.

3. To enable DHCPv6 server function on port.

Command	Explanation
Interface Configuration Mode	
ipv6 dhcp server <i><poolname></i> [preference <i><value></i>] [rapid-commit] [allow-hint] no ipv6 dhcp server	To enable DHCPv6 server function on specified port, and binding the used DHCPv6 address pool.

29.3 DHCPv6 Relay Delegation Configuration

DHCPv6 relay delegation configuration task list as below:

- 1 · To enable/disable DHCPv6 service
- 2 · To configure DHCPv6 relay delegation on port

1. To enable DHCPv6 service

Command	Explanation
Global Mode	
service dhcpv6 no service dhcpv6	To enable DHCPv6 service.

2. To configure DHCPv6 relay delegation on port

Command	Explanation
Interface Configuration Mode	

ipv6 dhcp relay destination { [<ipv6-address>] [interface { <interface-name> vlan <1-4096> }] } no ipv6 dhcp relay destination { [<ipv6-address>] [interface { <interface-name> vlan <1-4096> }] }	To specify the destination address of DHCPv6 relay transmit; The no form of this command delete the configuration.
---	--

29.4 DHCPv6 Prefix Delegation Server Configuration

DHCPv6 prefix delegation server configuration task list as below:

1. To enable/delete DHCPv6 service
2. To configure prefix delegation pool
3. To configure DHCPv6 address pool
 - (1) To achieve/delete DHCPv6 address pool
 - (2) To configure prefix delegation pool used by DHCPv6 address pool
 - (3) To configure static prefix delegation binding
 - (4) To configure other parameters of DHCPv6 address pool
4. To enable DHCPv6 prefix delegation server function on port

1. To enable/delete DHCPv6 service

Command	Explanation
Global Mode	
service dhcpv6 no service dhcpv6	To enable DHCPv6 service.

2. To configure prefix delegation pool

Command	Explanation
Global Mode	
ipv6 local pool <poolname> <prefix prefix-length> <assigned-length> no ipv6 local pool <poolname>	To configure prefix delegation pool.

3. To configure DHCPv6 address pool

- (1) To achieve/delete DHCPv6 address pool

Command	Explanation
Global Mode	
ipv6 dhcp pool <poolname> no ipv6 dhcp pool <poolname>	To configure DHCPv6 address pool.

- (2) To configure prefix delegation pool used by DHCPv6 address pool

Command	Explanation
DHCPv6 address pool Configuration Mode	

prefix-delegation pool <poolname> [lifetime { <valid-time> infinity} { <preferred-time> infinity}] no prefix-delegation pool <poolname>	To specify prefix delegation pool used by DHCPv6 address pool, and assign usable prefix to client.
--	--

(3) To configure static prefix delegation binding

Command	Explanation
DHCPv6 address pool Configuration Mode	
prefix-delegation <ipv6-prefix/prefix-length> <client-DUID> [iaid <iaid>] [lifetime { <valid-time> infinity} { <preferred-time> infinity}] no prefix-delegation <ipv6-prefix/prefix-length> <client-DUID> [iaid <iaid>]	To specify IPv6 prefix and any prefix required static binding by client.

(5) To configure other parameter of DHCPv6 address pool

Command	Explanation
DHCPv6 address pool Configuration Mode	
dns-server <ipv6-address> no dns-server <ipv6-address>	To configure DNS server address for DHCPv6 client.
domain-name <domain-name> no domain-name <domain-name>	To configure domain name for DHCPv6 client.

4. To enable DHCPv6 prefix delegation server function on port

Command	Explanation
Interface Configuration Mode	
ipv6 dhcp server <poolname> [preference <value>] [rapid-commit] [allow-hint] no ipv6 dhcp server	To enable DHCPv6 server function on specified port, and binding used DHCPv6 address pool.

29.5 DHCPv6 Prefix Delegation Client Configuration

DHCPv6 prefix delegation client configuration task list as below:

1. To enable/disable DHCPv6 service
2. To enable DHCPv6 prefix delegation client function on port

1. To enable/disable DHCPv6 service

Command	Explanation
Global Mode	
service dhcpv6 no service dhcpv6	To enable DHCPv6 service.

2. To enable DHCPv6 prefix delegation client function on port

Command	Explanation
Interface Configuration Mode	
ipv6 dhcp client pd <prefix-name> [rapid-commit] no ipv6 dhcp client pd	To enable client prefix delegation request function on specified port, and the prefix obtained associate with universal prefix configured.

29.6 DHCPv6 Configuration Examples

Example1:

When deploying IPv6 networking, XGS3 series switches can be configured as DHCPv6 server in order to manage the allocation of IPv6 addresses. Both the state and the stateless DHCPv6 are supported.

Topology:

The access layer use Switch1 switch to connect users of dormitory buildings; Switch2 is configured as DHCPv6 relay delegation in primary aggregation layer; Switch3 is configured as DHCPv6 server in secondary aggregation layer, and connected with backbone network or higher aggregation layers; The Windows Vista which be provided with DHCPv6 client must load on PC.

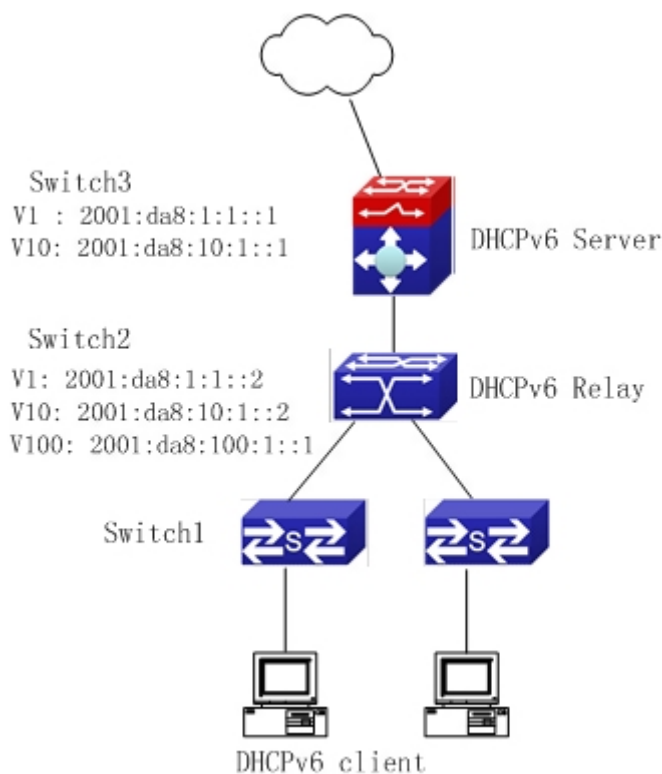

Usage guide:

Switch3 configuration :

```
Switch3>enable
Switch3#config
Switch3(config)#ipv6 enable
Switch3(config)#service dhcpv6
Switch3(config)#ipv6 dhcp pool EastDormPool
Switch3(dhcpv6-EastDormPool-config)#network-address 2001:da8:100:1::1 2001:da8:100:1::100
Switch3(dhcpv6-EastDormPool-config)#excluded-address 2001:da8:100:1::1
Switch3(dhcpv6-EastDormPool-config)#dns-server 2001:da8::20
Switch3(dhcpv6-EastDormPool-config)#dns-server 2001:da8::21
Switch3(dhcpv6-EastDormPool-config)#domain-name dhcpv6.com
Switch3(dhcpv6-EastDormPool-config)#lifetime 1000 600
Switch3(dhcpv6-EastDormPool-config)#exit
Switch3(config)#interface vlan 1
Switch3(Config-if-Vlan1)#ipv6 address 2001:da8:1:1::1/64
Switch3(Config-if-Vlan1)#exit
Switch3(config)#interface vlan 10
Switch3(Config-if-Vlan10)#ipv6 address 2001:da8:10:1::1/64
Switch3(Config-if-Vlan10)#ipv6 dhcp server EastDormPool preference 80
Switch3(Config-if-Vlan10)#exit
Switch3(config)#
```

Switch2 configuration :

```
Switch2>enable
Switch2#config
Switch2(config)#ipv6 enable
Switch2(config)#service dhcpv6
Switch2(config)#interface vlan 1
Switch2(Config-if-Vlan1)#ipv6 address 2001:da8:1:1::2/64
Switch2(Config-if-Vlan1)#exit
Switch2(config)#interface vlan 10
Switch2(Config-if-Vlan10)#ipv6 address 2001:da8:10:1::2/64
Switch2(Config-if-Vlan10)#exit
Switch2(config)#interface vlan 100
Switch2(Config-if-Vlan100)#ipv6 address 2001:da8:100:1::1/64
Switch2(Config-if-Vlan100)#no ipv6 nd suppress-ra
Switch2(Config-if-Vlan100)#ipv6 nd managed-config-flag
Switch2(Config-if-Vlan100)#ipv6 nd other-config-flag
Switch2(Config-if-Vlan100)#ipv6 dhcp relay destination 2001:da8:10:1::1
Switch2(Config-if-Vlan100)#exit
Switch2(config)#
```

Example2:

When the network operator is deploying IPv6 networks, network automatically configuration can be achieved through the prefix delegation allocation of IPv6 addresses, in stead of configuring manually for each switch:

1. To configure the switching or routing device which is connected to the client switch as DHCPv6 prefix delegation server, that is to setup a local database for the relationship between the allocated prefix and the DUID of the client switch.
2. To configure the switch as the prefix delegation client, and make the client switch to get IPv6 address prefix from the prefix delegation server, through a process which is much like the process of DHCPv6 address allocation.
3. The edge devices which receive the address prefix, send routing advertisement - RA messages, to the client hosts about the address prefix through the interface which is connected to the hosts, then the hosts get an valid IPv6 address through stateless auto configuration, while at the same time, the stateless DHCPv6 server will be configured for the interface, in order to provide the DHCPv6 client with information such as DNS, and domain name, etc.

Network Topology:

The edge switch is a Switch1 switch. The interface connected to the trunk switch which is Switch2, is configured as the prefix delegation client. The interfaces connected to hosts, are configured as stateless DHCPv6 servers to provide the hosts with stateless information such as DNS and domain names, also routing advertisement of stateless address allocation is enabled for the host interfaces; On Switch2, the prefix delegation server is configured, and routing advertisement of state address allocation is enabled; On the host side, DHCPv6 client capable operating system such Windows Vista should be installed.

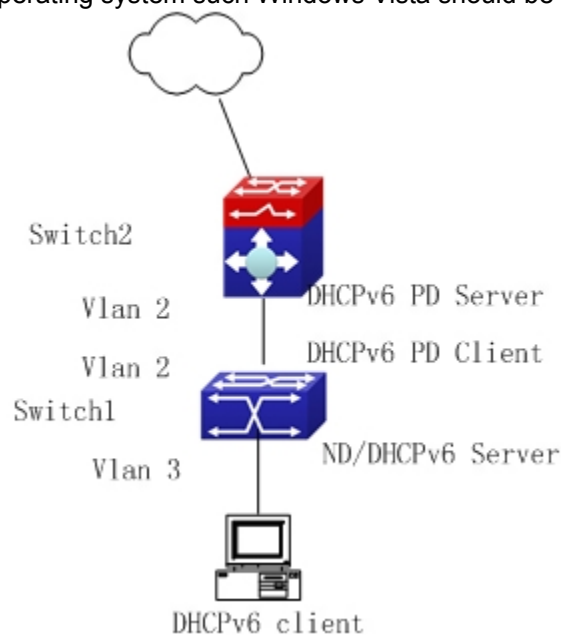

Usage guide:

Switch2 configuration

```
Switch2>enable
Switch2#config
Switch2(config)#ipv6 enable
Switch2(config)#interface vlan 2
Switch2(Config-if-Vlan2)#ipv6 address 2001:da8:1100::1/64
Switch2(Config-if-Vlan2)#exit
Switch2(config)#service dhcpv6
```

```
Switch2(config)#ipv6 local pool client-prefix-pool 2001:da8:1800::/40 48
Switch2(config)#ipv6 dhcp pool dhcp-pool
Switch2(dhcpv6-dhcp-pool-config)#prefix-delegation pool client-prefix-pool 1800 600
Switch2(dhcpv6-dhcp-pool-config)#exit
Switch2(config)#interface vlan 2
Switch2(Config-if-Vlan2)#ipv6 dhcp server dhcp-pool
Switch2(Config-if-Vlan2)#exit
```

Switch1 configuration

```
Switch1>enable
Switch1#config
Switch1(config)#ipv6 enable
Switch1(config)#service dhcpv6
Switch1(config)#interface vlan 2
Switch1(Config-if-Vlan2)#ipv6 dhcp client pd prefix-from-provider
Switch1(Config-if-Vlan2)#exit
Switch1(config)#interface vlan 3
Switch1(Config-if-Vlan3)#ipv6 address prefix-from-provider 0:0:0:1::1/64
Switch1(Config-if-Vlan3)#exit
Switch1(config)#ipv6 dhcp pool foo
Switch1(dhcpv6-foo-config)#dns-server 2001:4::1
Switch1(dhcpv6-foo-config)#domain-name www.ipv6.org
Switch1(dhcpv6-foo-config)#exit
Switch1(config)#interface vlan 3
Switch1(Config-if-Vlan3)#ipv6 dhcp server foo
Switch1(Config-if-Vlan3)#ipv6 nd other-config-flag
Switch1(Config-if-Vlan3)#no ipv6 nd suppress-ra
Switch1(Config-if-Vlan3)#exit
```

29.7 DHCPv6 Troubleshooting

If the DHCPv6 clients cannot obtain IPv6 addresses and other network parameters, the following procedures can be followed when DHCPv6 client hardware and cables have been verified ok:

- Verify the DHCPv6 server is running, start the related DHCP v6 server function if not running;
- If the DHCPv6 clients and servers are not in the same physical network, verify the router responsible for DHCPv6 packet forwarding has DHCPv6 relay function. If DHCPv6 relay is not available for the intermediate router, it is recommended to replace the router or upgrade its software to one that has a DHCPv6 relay function;
- Sometimes hosts are connected to the DHCPv6 enabled switches, but can not get IPv6 addresses. In this situation, it should be checked first whether the ports which the hosts are connected to, are connected with the port which the DHCPv6 server is connected to. If connected directly, it should be checked then whether the IPv6 address pool of the VLAN which the port belongs to, is in the same subnet with the address pool configure in the DHCPv6 server; If not connected directly, and any layer three DHCPv6 relay is configured between the hosts and the DHCPv6 server, it should be checked first

whether an valid IPv6 address has been configured for the switch interface which the hosts are connected to. If not configured, configure an valid IPv6 address. If configured, it should be checked whether the configured IPv6 address is in the same subnet with the DHCPv6 server. If not, please add it to the address pool.

Chapter 30 DHCP Option 82 Configuration

30.1 Introduction to DHCP Option 82

DHCP option 82 is the Relay Agent Information Option, its option code is 82. DHCP option 82 is aimed at strengthening the security of DHCP servers and improving the IP address configuration policy. The Relay Agent adds option 82 (including the client's physical access port, the access device ID and other information), to the DHCP request message from the client then forwards the message to DHCP server. When the DHCP server which supports the option 82 function receives the message, it will allocate an IP address and other configuration information for the client according to preconfigured policies and the option 82 information in the message. At the same time, DHCP server can identify all the possible DHCP attack messages according to the information in option 82 and defend against them. DHCP Relay Agent will peel the option 82 from the reply messages it receives, and forward the reply message to the specified port of the network access device, according to the physical port information in the option. The application of DHCP option 82 is transparent for the client.

30.1.1 DHCP Option 82 Message Structure

A DHCP message can have several option segments; option 82 is one of them. It has to be placed after other options but before option 255. The following is its format:

Code	Len	Agent Information Field					
82	N	i1	i2	i3	i4	...	iN

Code: represents the sequence number of the relay agent information option, the option 82 is called so because RFC3046 is defined as 82.

Len: the number of bytes in Agent Information Field, not including the two bytes in Code segment and Len segment.

Option 82 can have several sub-options, and need at least one sub-option. RFC3046 defines the following two sub-options, whose formats are showed as follows:

SubOpt	Len	Sub-option Value					
1	N	s1	s2	s3	s4	...	sN

SubOpt	Len	Sub-option Value					
2	N	i1	i2	i3	i4	...	iN

SubOpt: the sequence number of sub-option, the sequence number of Circuit ID sub-option is 1, the sequence number of Remote ID sub-option is 2.

Len: the number of bytes in Sub-option Value, not including the two bytes in SubOpt segment and Len segment.

30.1.2 Option 82 Working Mechanism

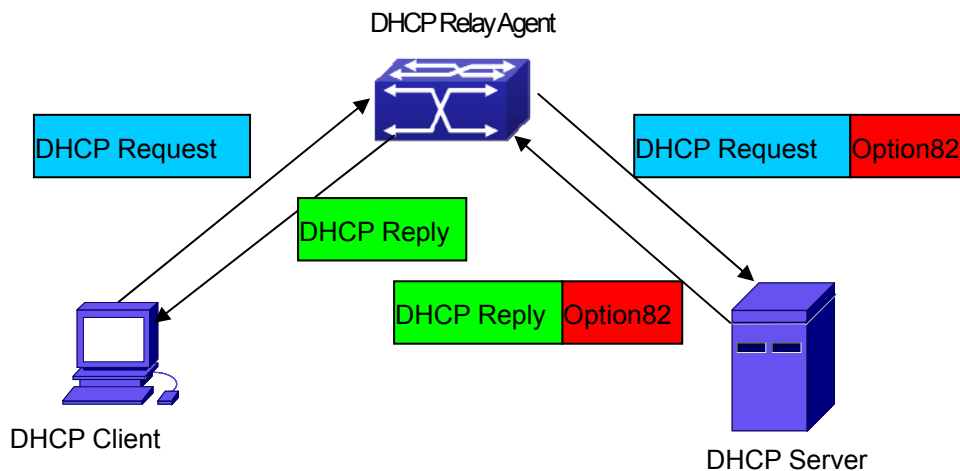

Figure 30-1-1 DHCP option 82 flow chart

If the DHCP Relay Agent supports option 82, the DHCP client should go through the following four steps to get its IP address from the DHCP server: discover, offer, select and acknowledge. The DHCP protocol follows the procedure below:

- 1) DHCP client sends a request broadcast message while initializing. This request message does not have option 82.
- 2) DHCP Relay Agent will add the option 82 to the end of the request message it receives, then relay and forward the message to the DHCP server. By default, the sub-option 1 of option 82 (Circuit ID) is the interface information of the switch connected to the DHCP client (VLAN name and physical port name), but the users can configure the Circuit ID as they wish. The sub-option 2 of option 82 (Remote ID) is the MAC address of the DHCP relay device.
- 3) After receiving the DHCP request message, the DHCP server will allocate IP address and other information for the client according to the information and preconfigured policy in the option segment of the message. Then it will forward the reply message with DHCP configuration information and option 82 information to DHCP Relay Agent.
- 4) DHCP Relay Agent will peel the option 82 information from the reply message sent by DHCP server, and then forward the message with DHCP configuration information to the DHCP client.

30.2 DHCP Option 82 Configuration Task List

- 1 · Enabling the DHCP option 82 of the Relay Agent.
- 2 · Configure the DHCP option 82 attributes of the interface.
- 3 · Enable the DHCP option 82 of server.
- 4 · Diagnose and maintain DHCP option 82.

1. Enabling the DHCP option 82 of the Relay Agent.

Command	Explanation
Global mode	
ip dhcp relay information option no ip dhcp relay information option	Set this command to enable the option 82 function of the switch Relay Agent. The “no ip dhcp relay information option” is used to disable the option 82 function of the switch Relay Agent.

2. Configure the DHCP option 82 attributes of the interface

Command	Explanation
Interface configuration mode	
ip dhcp relay information policy {drop keep replace} no ip dhcp relay information policy	This command is used to set the retransmitting policy of the system for the received DHCP request message which contains option 82. The drop mode means that if the message has option82, then the system will drop it without processing; keep mode means that the system will keep the original option 82 segment in the message, and forward it to the server to process; replace mode means that the system will replace the option 82 segment in the existing message with its own option 82, and forward the message to the server to process. The “no ip dhcp relay information policy” will set the retransmitting policy of the option 82 DHCP message as “replace”.
ip dhcp relay information option subscriber-id {standard <circuit-id>} no ip dhcp relay information option subscriber-id	This command is used to set the format of option 82 sub-option1(Circuit ID option) added to the DHCP request messages from interface, standard means the standard VLAN name and physical port name format, like“Vlan2+Ethernet1/12”,<circuit-id> is the circuit-id contents of option 82 specified by users, which is a string no longer than 64characters. The” no ip dhcp relay information option subscriber-id ” command will set the format of added option 82 sub-option1 (Circuit ID option) as standard format.

3. Enable the DHCP option 82 of server.

Command	Explanation
Global mode	
ip dhcp server relay information enable no ip dhcp server relay information enable	This command is used to enable the switch DHCP server to identify option82. The “ no ip dhcp server relay information enable ” command will make the server ignore the option 82.

4. Diagnose and maintain DHCP option 82

Command	Explanation
Admin mode	
show ip dhcp relay information option	This command will display the state information of the DHCP option 82 in the system, including option82 enabling switch, the interface retransmitting policy, the circuit ID mode and the DHCP server option82 enabling switch.
debug ip dhcp relay packet	This command is used to display the information of data packets processing in DHCP Relay Agent, including the “add” and “peel” action of option 82.

30.3 DHCP Option 82 Application Examples

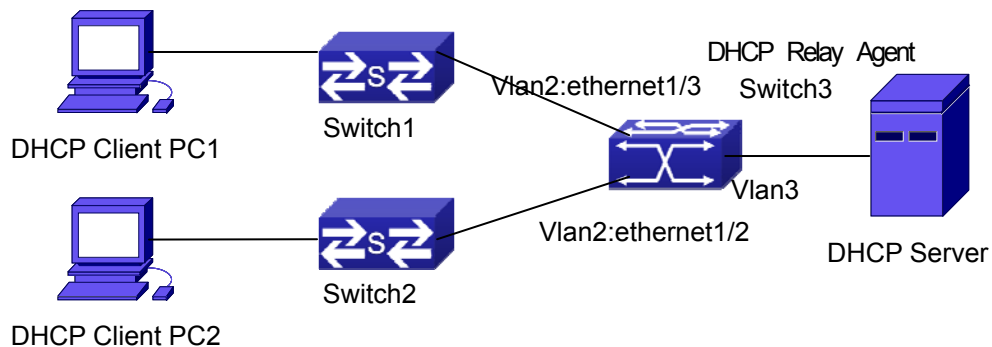

Figure 30-3-1 A DHCP option 82 typical application example

In the above example, layer 2 switches Switch1 and Switch2 are both connected to layer 3 switch Switch3, Switch 3 will transmit the request message from DHCP client to DHCP server as DHCP Relay Agent. It will also transmit the reply message from the server to DHCP client to finish the DHCP protocol procedure. If the DHCP option 82 is disabled, DHCP server cannot distinguish that whether the DHCP client is from the network connected to Switch1 or Switch2. So, all the PC terminals connected to Switch1 and Switch2 will get addresses from the public address pool of the DHCP server. After the DHCP option 82 function is enabled, since the Switch3 appends the port information of accessing Switch3 to the request message from the client, the server can tell that whether the client is from the network of Switch1 or Switch2, and thus can allocate separate address spaces for the two networks, to simplify the management of networks.

The following is the configuration of Switch3(MAC address is 00:03:0f:02:33:01):

```
Switch3(config)#service dhcp
Switch3(config)#ip dhcp relay information option
Switch3(config)#ip forward-protocol udp bootps
Switch3(Config-if-vlan3)#ip address 192.168.10.222 255.255.255.0
Switch3(Config-if-vlan2)#ip address 192.168.102.2 255.255.255.0
Switch3(Config-if-vlan2)#ip helper 192.168.10.88
```

Linux ISC DHCP Server supports option 82, its configuration file /etc/dhcpd.conf is ddns-update-style interim; ignore client-updates;

```
class "Switch3Vlan2Class1" {
match if option agent.circuit-id = "Vlan2+Ethernet1/2" and option agent.remote-id=00:03:0f:02:33:01;
}

class "Switch3Vlan2Class2" {
match if option agent.circuit-id = "Vlan2+Ethernet1/3" and option agent.remote-id=00:03:0f:02:33:01;
}

subnet 192.168.102.0 netmask 255.255.255.0 {
option routers 192.168.102.2;
option subnet-mask 255.255.255.0;
option domain-name "example.com.cn";
option domain-name-servers 192.168.10.3;
authoritative;

pool {
range 192.168.102.21 192.168.102.50;
default-lease-time 86400; #24 Hours
max-lease-time 172800; #48 Hours
allow members of "Switch3Vlan2Class1";
}

pool {
range 192.168.102.51 192.168.102.80;
default-lease-time 43200; #12 Hours
max-lease-time 86400; #24 Hours
allow members of "Switch3Vlan2Class2";
}
}
```

Now, the DHCP server will allocate addresses for the network nodes from Switch1 which are relayed by Switch3 within the range of 192.168.102.21 ~ 192.168.102.50, and allocate addresses for the network nodes from Switch1 within the range of 192.168.102.51 ~ 192.168.102.80.

Chapter 31 DHCP Snooping Configuration

31.1 Introduction to DHCP Snooping

DHCP Snooping means that the switch monitors the IP-getting process of DHCP CLIENT via DHCP protocol. It prevents DHCP attacks and illegal DHCP SERVER by setting trust ports and untrusted ports. And the DHCP messages from trust ports can be forwarded without being verified. In typical settings, trust ports are used to connect DHCP SERVER or DHCP RELAY Proxy, and untrusted ports are used to connect DHCP CLINET. The switch will forward the DHCP request messages from untrusted ports, but not DHCP reply ones. If any DHCP reply messages is received from a untrusted port, besides giving an alarm, the switch will also implement designated actions on the port according to settings, such as “shutdown”, or distributing a “blackhole”. If DHCP Snooping binding is enabled, the switch will save binding information (including its MAC address, IP address, IP lease, VLAN number and port number) of each DHCP CLINET on untrusted ports in DHCP snooping binding table. With such information, DHCP Snooping can combine modules like dot1x and ARP, or implement user-access-control independently.

Defense against Fake DHCP Server: once the switch intercepts the DHCP Server reply packets (including DHCP OFFER, DHCPACK, and DHCPNAK) , it will alarm and respond according to the situation (shutdown the port or send Black hole) .

Defense against DHCP over load attacks: To avoid too many DHCP messages attacking CPU, users should limit the DHCP speed of receiving packets on trusted and non-trusted ports.

Record the binding data of DHCP: DHCP SNOOPING will record the binding data allocated by DHCP SERVER while forwarding DHCP messages, it can also upload the binding data to the specified server to backup it. The binding data is mainly used to configure the dynamic users of dot1x user based ports. Please refer to the chapter called “dot1x configuration” to find more about the usage of dot1x use-based mode.

Add binding ARP: DHCP SNOOPING can add static binding ARP according to the binding data after capturing binding data, thus to avoid ARP cheating.

Add trusted users: DHCP SNOOPING can add trusted user list entries according to the parameters in binding data after capturing binding data; thus these users can access all resources without DOT1X authentication.

Automatic Recovery: A while after the switch shut down the port or send blockhole, it should automatically recover the communication of the port or source MAC and send information to Log Server via syslog.

LOG Function: When the switch discovers abnormal received packets or automatically recovers, it should send syslog information to Log Server.

The Encryption of Private Messages: The communication between the switch and the inner network security management system TrustView uses private messages. And the users can encrypt those messages of version 2.

Add option82 Function: It is used with dot1x dhchoption82 authentication mode. Different option 82 will be added in DHCP messages according to user’s authentication status.

31.2 DHCP Snooping Configuration Task Sequence

1. Enable DHCP Snooping
2. Enable DHCP Snooping binding function
3. Enable DHCP Snooping binding ARP function
4. Enable DHCP Snooping option82 function
5. Set the private packet version
6. Set DES encrypted key for private packets
7. Set helper server address
8. Set trusted ports
9. Enable DHCP Snooping binding DOT1X function
10. Enable DHCP Snooping binding USER function
11. Adding static list entries function
12. Set defense actions
13. Set rate limitation of DHCP messages
14. Enable the debug switch

1 · Enable DHCP Snooping

Command	Explanation
Globe mode	
ip dhcp snooping enable no ip dhcp snooping enable	Enable or disable the DHCP snooping function.

2 · Enable DHCP Snooping binding

Command	Explanation
Globe mode	
ip dhcp snooping binding enable no ip dhcp snooping binding enable	Enable or disable the DHCP snooping binding function.

3 · Enable DHCP Snooping binding ARP function

Command	Explanation
Globe mode	
ip dhcp snooping binding arp no ip dhcp snooping binding arp	Enable or disable the dhcp snooping binding ARP function.

4 · Enable DHCP Snooping option82 function

Command	Explanation
Globe mode	
ip dhcp snooping information enable no ip dhcp snooping information enable	Enable/disable DHCP Snooping option 82 function.
ip dhcp snooping option82 enable no ip dhcp snooping option82 enable	To enable/delete DHCP option82 of dot1x in access switch.

5 · Set the private packet version

Command	Explanation
Globe mode	
ip user private packet version two no ip user private packet version two	To configure/delete the private packet version.

6 · Set DES encrypted key for private packets

Command	Explanation
Globe mode	
enable trustview key 0/7 <password> no enable trustview key	To configure/delete DES encrypted key for private packets.

7 · Set helper server address

Command	Explanation
Globe mode	
ip user helper-address A.B.C.D [port <udpport>] source <ipAddr> (secondary) no ip user helper-address (secondary)	Set or delete helper server address.

8 · Set trusted ports

Command	Explanation
Port mode	
ip dhcp snooping trust no ip dhcp snooping trust	Set or delete the DHCP snooping trust attributes of ports.

9 · Enable DHCP SNOOPING binding DOT1X function

Command	Explanation
Port mode	
ip dhcp snooping binding dot1x no ip dhcp snooping binding dot1x	Enable or disable the DHCP snooping binding dot1x function.

10 · Enable or disable the DHCP SNOOPING binding USER function

Command	Explanation
Port mode	
ip dhcp snooping binding user-control no ip dhcp snooping binding user-control	Enable or disable the DHCP snooping binding user function.

11 · Add static binding information

Command	Explanation
Globe mode	

<pre>ip dhcp snooping binding user <mac> address <ipAddr> <mask> vlan <vid> interface (ethernet) <ifname> no ip dhcp snooping binding user <mac> interface (ethernet) <ifname></pre>	<p>Add/delete DHCP snooping static binding list entries.</p>
--	--

12 · Set defense actions

Command	Explanation
Port mode	
<pre>ip dhcp snooping action {shutdown blackhole} [recovery <second>] no ip dhcp snooping action</pre>	<p>Set or delete the DHCP snooping automatic defense actions of ports.</p>

13 · Set rate limitation of data transmission

Command	Explanation
Globe mode	
<pre>ip dhcp snooping limit-rate <pps> no ip dhcp snooping limit-rate</pre>	<p>Set rate limitation of the transmission of DHCP snooping messages.</p>

14 · Enable the debug switch

Command	Explanation
Admin mode	
<pre>debug ip dhcp snooping packet debug ip dhcp snooping event debug ip dhcp snooping update debug ip dhcp snooping binding</pre>	<p>Please refer to the chapter on system troubleshooting.</p>

31.3 DHCP Snooping Typical Application

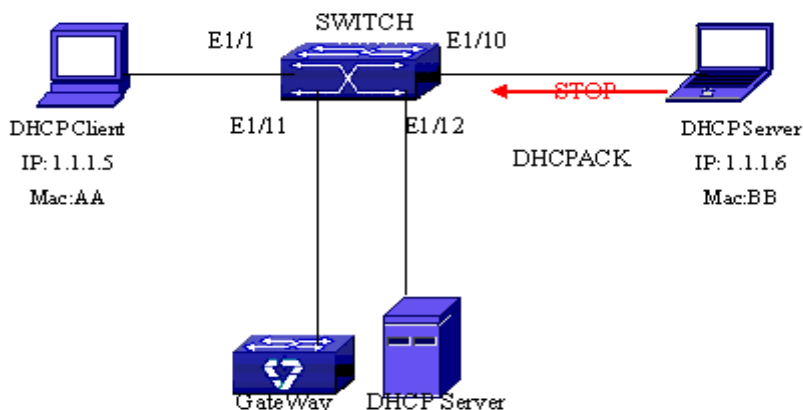

Figure 31-3-1 Sketch Map of TRUNK

As shown in the above chart, Mac-AA device is the normal user, connected to the non-trusted port 1/1 of the switch. It operates via DHCP Client, IP 1.1.1.5; DHCP Server and GateWay are connected to the trusted ports 1/11 and 1/12 of the switch; the malicious user Mac-BB is connected to the non-trusted port 1/10, trying to fake a DHCP Server (by sending DHCPACK. Setting DHCP Snooping on the switch will effectively detect and block this kind of network attack.

Configuration sequence is:

```
XGS3-42000R#
XGS3-42000R#config
XGS3-42000R(config)#ip dhcp snooping enable
XGS3-42000R(config)#interface ethernet 1/11
XGS3-42000R(config-If-Ethernet1/11)#ip dhcp snooping trust
XGS3-42000R(config-If-Ethernet1/11)#exit
XGS3-42000R(config)#interface ethernet 1/12
XGS3-42000R(config-If-Ethernet1/12)#ip dhcp snooping trust
XGS3-42000R(config-If-Ethernet1/12)#exit
XGS3-42000R(config)#interface ethernet 1/1-10
XGS3-42000R(config-Port-Range)#ip dhcp snooping action shutdown
XGS3-42000R(config-Port-Range)#
```

31.4 DHCP Snooping Troubleshooting Help

31.4.1 Monitor and Debug Information

The “debug ip dhcp snooping” command can be used to monitor the debug information.

31.4.2 DHCP Snooping Troubleshooting Help

If there is any problem happening when using DHCP Snooping function, please check if the problem is caused by the following reasons:

- Check whether the global DHCP Snooping is enabled;
- If the port does not react to invalid DHCP Server packets, please check whether the port is set as a non-trusted port of DHCP Snooping.

Chapter 32 DHCPv6 Snooping Configuration

32.1 Introduction to DHCPv6 Snooping

DHCPv6 Snooping monitors the interaction flow of the packets between DHCPv6 client and server, so as to create the binding table of the user, and implement all kinds of security policies based on the binding table. DHCPv6 Snooping has the following functions:

32.1.1 Defense against Fake DHCPv6 Server

DHCPv6 Snooping can set the port of connecting DHCPv6 server as the trusted port, other ports as the un-trusted ports by default, so as to avoid the user to configure DHCPv6 server privately in network. DHCPv6 Snooping does not forward DHCPv6 response packets which are received by the un-trusted ports, and according to the source MAC of the received DHCPv6 response packets to implement the security policy. For example, this MAC is set as a blackhole MAC within a period, or this port is directly shut down within a period.

32.1.2 Defense against Fake IPv6 Address

DHCPv6 Snooping function can send the control list entries based on the binding on the port. The port denies all IPv6 traffic by default. It only allows to forward IPv6 packets of which the IPv6 addresses and the MAC addresses are bound by this port as the source. In this way, it can effectively prevent the malicious user fake or privately set IPv6 address to access the network.

32.1.3 Defense against the Attack of DHCPv6 Addresses

Exhaustion

DHCPv6 Snooping can limit the binding number of the port. The port of which the binding number exceeds the threshold, does not forward and drop the after DHCPv6 application packets. In this way, it can effectively prevent the attack of DHCPv6 addresses exhaustion.

32.1.4 Defense against ND Cheat

The IPv6 address obtained by DHCPv6 protocol can be trustier in IPv6 network, so DHCPv6 Snooping can convert the binding list entries to static one, and effectively prevent the attack of ND cheat to a gateway device. The function of binding ND for DHCPv6 Snooping needs to be enabled on the device of layer 3 gateway.

32.1.5 Reply the Removal Requirement for Port

Through capturing the ports of DHCPv6 packets, DHCPv6 Snooping judges the port connected to the DHCPv6 user. After DHCPv6 Snooping binding is created, if DHCPv6 Snooping receives CONFIRM/REQUEST packets and response packets of DHCPv6 client from other ports, it needs to use DAD NS/NA to detect whether the binding of the original port is still usable. If it is still usable (that means to receive the response of DAD NA), then do not create new binding on new port, contrarily (that means the response of DAD NA is not received in set time), create the binding on new port and deletes the binding on the original port.

32.2 DHCPv6 Snooping Configuration Task Sequence

1. Enable DHCPv6 Snooping
2. Enable DHCPv6 Snooping binding function
3. Enable DHCPv6 Snooping binding ND function
4. Delete dynamic binding information for DHCPv6 Snooping
5. Set the binding limitation number for the ports
6. Configure static binding list entries
7. Set trusted ports
8. Set defense actions
9. Set the max. number for Blackhole MAC
10. Enable user access control function
11. Enable the debug
12. Show the configuration status

1. Enable DHCPv6 Snooping

Command	Explanation
Global mode	
ipv6 dhcp snooping enable no ipv6 dhcp snooping enable	Enable or disable DHCPv6 Snooping function.

2. Enable DHCPv6 Snooping binding function

Command	Explanation
Global mode	
ipv6 dhcp snooping binding enable no ipv6 dhcp snooping binding enable	Enable or disable DHCPv6 Snooping binding function.

3. Enable DHCPv6 Snooping binding ND function

Command	explanation
Global mode	
ipv6 dhcp snooping binding nd no ipv6 dhcp snooping binding nd	Enable or disable DHCPv6 Snooping binding ND function.

4. Delete dynamic binding information for DHCPv6 Snooping

Command	Explanation
Admin mode	
clear ipv6 dhcp snooping binding {<MAC> <ipv6address> interface {ethernet <IFNAME> <IFNAME>} all}	Delete the dynamic binding information for DHCPv6 Snooping.

5. Set the binding limitation number for the ports

Command	Explanation
Port mode	
ipv6 dhcp snooping binding-limit <max-num> no ipv6 dhcp snooping binding-limit	Set or delete the max number of DHCPv6 Snooping dynamic binding which is allowed to set up on the port.

6. Configure static binding list entries

Command	explanation
Global mode	
ipv6 dhcp snooping binding user mac <MAC-address> address <ipv6-address> vlan <vid> interface [ethernet port-channel] <ifname> no ipv6 dhcp snooping binding user mac <MAC-address>	Configure or delete the configured static binding list entries.

7. Set trusted ports

Command	Explanation
Port mode	
ipv6 dhcp snooping trust no ipv6 dhcp snooping trust	Set or delete DHCPv6 Snooping trust attribute for the ports.

8. Set defense actions

Command	Explanation
Port mode	
ipv6 dhcp snooping action {shutdown blackhole} [recovery <second>] no ipv6 dhcp snooping action	Set or delete the automatic defense actions of DHCPv6 Snooping for the ports.

9. Set the max number of Blackhole MAC

Command	Explanation
Global mode	
ipv6 dhcp snooping action {<max-num> default}	Set the max number of blackhole MAC which can be sent by each un-trusted port.

10. Enable user access control function

Command	Explanation
Port mode	
<pre> ipv6 dhcp snooping binding user-control no ipv6 dhcp snooping binding user-control </pre>	Enable or disable the user access control function is bound by DHCPv6 Snooping.

11. Enable the debug switch

Command	Explanation
Admin mode	
<pre> debug ipv6 dhcp snooping packet debug ipv6 dhcp snooping event debug ipv6 dhcp snooping binding </pre>	Enable the debug of DHCP Snooping.

12. Show the configuration status

Command	Explanation
Admin mode	
<pre> show ipv6 dhcp snooping show ipv6 dhcp snooping interface <szIfName> show ipv6 dhcp snooping binding {<MAC> <ipv6address> interface {ethernet <IFNAME> <IFNAME>} all} </pre>	Show DHCP Snooping and binding information.

32.3 DHCPv6 Snooping Typical Application

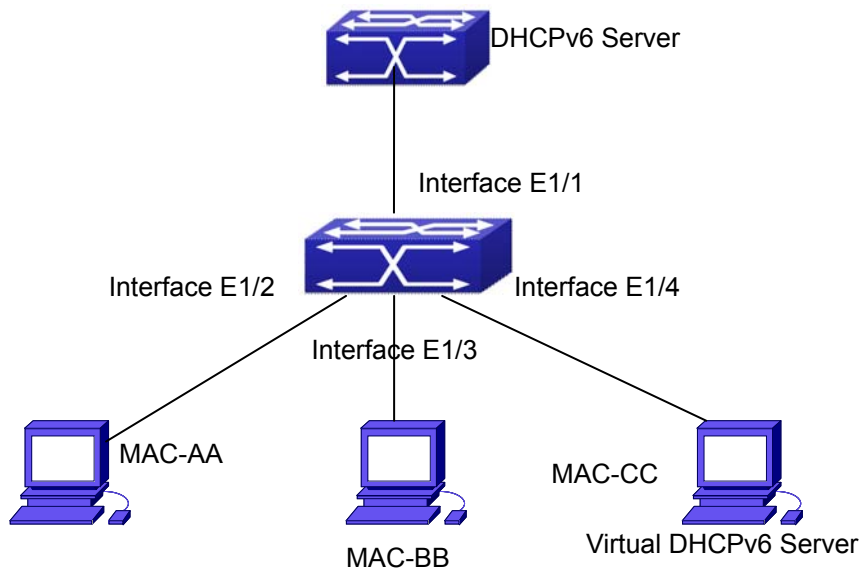

Figure 32-3-1 Sketch Map of preventing lawless DHCPv6 Server

As shown in the above chart, MAC-AA and MAC-BB devices are normal users. They are connected to the non-trusted ports 1/2 and 1/3 of the switch, and obtain IP 2010::3 and IP 2010::4 through DHCPv6 Client; DHCPv6 Server are connected to the trusted port 1/1 of the switch; the malicious user Mac-CC is connected to the non-trusted port1/4, it tries to fake DHCPv6 Server. Setting DHCPv6 Snooping on the switch will effectively detect and prevent this kind of network attack.

Configuration sequence is:

```
XGS3-42000R#
XGS3-42000R#config
XGS3-42000R(config)#ipv6 dhcp snooping enable
XGS3-42000R(config)#ipv6 dhcp snooping binding enable
XGS3-42000R(config)#interface ethernet 1/1
XGS3-42000R(config-Ethernet 1/1)#ipv6 dhcp snooping trust
XGS3-42000R(config-Ethernet1/1)#exit
XGS3-42000R(config)#interface ethernet 1/4-10
XGS3-42000R(config-Port-Range)#ipv6 dhcp snooping action shutdown
XGS3-42000R(config-Port-Range)#
```

32.4 DHCPv6 Snooping Troubleshooting

32.4.1 Monitor and Debug Information

The “debug ipv6 dhcp snooping” command can be used to monitor the debug information.

32.4.2 DHCPv6 Snooping Troubleshooting Help

If there is any problem happening when using DHCPv6 Snooping function, please check whether the problem is caused by the following reasons:

- Check whether the DHCPv6 Snooping is enabled globally;
- If DHCP client does not obtain IP when configuring DHCPv6 Snooping, please check whether the port connected by DHCPv6 server/relay is set as a trusted port.

Chapter 33 Routing Protocol Overview

To communicate with a remote host over the Internet, a host must choose a proper route via a set of routers or Layer3 switches. Both routers and Layer3 switches calculate the route using CPU, the difference is that Layer3 switch adds the calculated route to the switch chip and forward by the chip at wire speed, while the router always store the calculated route in the route table or route buffer, and data forwarding is performed by the CPU. For this reason, although both routers and switches can perform route selection, Layer3 switches have great advantage over routers in data forwarding. The following describes basic principle and methods used in Layer3 switch route selection.

In route selection, the responsibility of each Layer3 switch is to select a proper midway route according to the destination of the packet received; and send the packet to the next Layer3 switch until the last Layer3 switch in the route send the packet to the destination host. A route is the path selected by each Layer3 switch to pass the packet to the next Layer3 switch. Route can be grouped into direct route, static route and dynamic route.

Direct route refer to the path directly connects to the Layer3 switch, and can be obtained with no calculation.

Static route is the manually specified path to a network or a host; static route cannot be changed freely. The advantage of static route is simple and consistent, and it can limit illegal route modification, and is convenient for load balance and route backup. However, as this is set manually, it is not suitable for mid- or large-scale networks for the route in such conditions are too huge and complex.

Dynamic route is the path to a network or a host calculated by the Layer3 switch according to the routing protocols enabled. If the next hop Layer3 switch in the path is not reachable, Layer3 switch will automatically discard the path to that next hop Layer3 switch and choose the path through other Layer3 switches.

There are two dynamic routing protocols: Interior Gateway Protocol (IGP) and Exterior Gateway protocol (EGP). IGP is the protocol used to calculate the route to a destination inside an autonomous system. IGP supported by switch include RIP and OSPF, RIP and OSRF can be configured according to the requirement. Switch supports running several IGP dynamic routing protocols at the same time. Or, other dynamic routing protocols and static route can be introduced to a dynamic routing protocol, so that multiple routing protocols can be associated.

EGP is used to exchange routing information among different autonomous systems, such as BGP protocol. EGP supported by switch include BGP-4, BGP-4+.

33.1 Routing Table

As mentioned before, Layer3 switch is mainly used to establish the route from the current Layer3 switch to a network or a host, and to forward packets according to the route. Each Layer3 switch has its own route table containing all routes used by that switch. Each route entry in the route table specifies the physical port should be used for forwarding packet to reach a destination host or the next hop Layer3 switch to the host.

The route table mainly consists of the following:

- Destination address: used to identify the destination address or destination network of an IP

packet.

- Network mask: used together with destination address to identify the destination host or the network the Layer3 switch resides. Network mask consists of several consecutive binary 1's, and usually in the format of dotted decimal (an address consists of 1 to 4 255's.) When "AND" the destination address with network mask, we can get the network address for the destination host or the network the Layer3 switch resides. For example, the network address of a host or the segment the Layer3 switch resides with a destination address of 200.1.1.1 and mask 255.255.255.0 is 200.1.1.0.
- Output interface: specify the interface of Layer3 switch to forward IP packets.
- IP address of the next Layer3 XGS3-42000R(next hop): specify the next Layer3 switch the IP packet will pass.
- Route entry priority: There may be several different next hop routes leading to the same destination. Those routes may be discovered by different dynamic routing protocols or static routes manually configured. The entry with the highest priority (smallest value) becomes the current best route. The user can configure several routes of different priority to the same destination; Layer3 switch will choose one route for IP packet forwarding according to the priority order.

To prevent too large route table, a default route can be set. Once route table look up fails, the default route will be chosen for forwarding packets.

The table below describes the routing protocols supported by switch and the default route look up priority value.

Routing Protocols or route type	Default priority value
Direct route	0
OSPF	110
Static route	1
RIP	120
OSPF ASE	150
IBGP	200
EBGP	20
Unknown route	255

33.2 IP Routing Policy

33.2.1 Introduction to Routing Policy

Some policies have to be applied when the router publishing and receiving routing messages so to filter routing messages, such as only receiving or publishing routing messages meets the specified conditions. A routing protocol maybe need redistribute other routing messages found by other protocols such as OSPF so to increase its own routing knowledge; when the router redistributing routing messages from other routing protocols there may be only part of the qualified routing messages is needed, and some properties may have to be configured to suit this protocol.

To achieve routing policy, first we have to define the characteristics of the routing messages to be applied with routing policies, namely define a group matching rules. We can configure by different properties in the routing messages such as destination address, the router address publishing the routing messages. The matching rules can be previously configured to be applied in the routing publishing, receiving and distributing policies. Five filters are provided in switch: route-map, acl, as-path, community-list and ip-prefix for use. We will introduce each filter in following sections:

1. route-map

For matching certain properties of the specified routing information and setting some routing properties when the conditions are fulfilled. Route-map is for controlling and changing the routing messages while also controlling the redistribution among routes. A route-map consists of a series of match and set commands in which the match command specifies the conditions required matching, and the set command specifies the actions to be taken when matches. The route-map is also for controlling route publishing among different route process. It can also used on policy routing which select different routes for the messages other than the shortest route.

A group matches and set clauses make up a node. A route-map may consist of several nodes each of which is a unit for matching test. We match among nodes with by sequence-number. Match clauses define matching rules. The matching objects are some properties of routing messages. Different match clause in the same node is “and” relation logically, which means the matching test of a node, will not be passed until conditions in its entire match clause are matched. Set clause specifies actions, namely configure some properties of routing messages after the matching test is passed.

Different nodes in a route-map is an “or” relation logically. The system checks each node of the route-map in turn and once certain node test is passed the route-map test will be passed without taking the next node test.

2. access control list(acl)

ACL (Access Control Lists) is a data packet filter mechanism in the switch. The switch controls the network access and secure the network service by permitting or denying certain data packet transmitting out from or into the network. Users can establish a group of rules by certain messages in the packet, in which each rule to be applied on certain amount of matching messages: permit or deny. The users can apply these rules to the entrance or exit of specified switch, with which data stream in certain direction on certain port would have to follow the specified ACL rules in-and-out the switch. Please refer to chapter “ACL Configuration”.

3. Ip-prefix list

The ip-prefix list acts similarly to acl while more flexible and more understandable. The match object of ip-prefix is the destination address messages field of routing messages when applied in routing messages filtering.

An ip-prefix is identified by prefix list name. Each prefix list may contain multiple items, each of which specifies a matching range of a network prefix type and identifies with a sequence-number which specifies the matching check order of ip-prefix.

In the process of matching, the switch check each items identified by sequence-number in ascending order and the filter will be passed once certain items is matched(without checking rest items)

4. Autonomic system path information access-list as-path

The autonomic system path information access-list as-path is only used in BGP. In the BGP routing messages packet there is an autonomic system path field (in which autonomic system path the routing messages passes through is recorded). As-path is specially for specifying matching conditions for autonomic system path field.

As for relevant as-path configurations, please refer to the ip as-path command in BGP configuration.

5. community-list

Community-list is only for BGP. There is a community property field in the BGP routing messages packet for identifying a community. The community list is for specifying matching conditions for Community-list field.

As for relevant Community-list configuration, please refer to the ip as-path command in BGP configuration

33.2.2 IP Routing Policy Configuration Task List

- 1 · Define route-map
- 2 · Define the match clause in route-map
- 3 · Define the set clause in route-map
- 4 · Define address prefix list

1. Define route-map

Command	Explanation
Global mode	
route-map <map_name> {deny permit} <sequence_num> no route-map <map_name> [{deny permit} <sequence_num>]	Configure route-map; the no route-map <map_name> [{deny permit} <sequence_num>] command deletes the route-map.

2. Define the match clause in route-map

Command	Explanation
Route-map configuration mode	
match as-path <list-name> no match as-path [<list-name>]	Match the autonomous system as path access-list the BGP route passes through; the no match as-path [<list-name>] command deletes match condition.

<p>match community <community-list-name community-list-num > [exact-match] no match community [<community-list-name community-list-num > [exact-match]]</p>	<p>Match a community property access-list. The no match community [<community-list-name community-list-num > [exact-match]] command deletes match condition.</p>
<p>match interface <interface-name > no match interface [<interface-name >]</p>	<p>Match by ports; The no match interface [<interface-name >] command deletes match condition.</p>
<p>match ip <address next-hop> <ip-acl-name ip-acl-num prefix-list list-name> no match ip <address next-hop> [<ip-acl-name ip-acl-num prefix-list [list-name]>]</p>	<p>Match the address or next-hop; The no match ip <address next-hop> [<ip-acl-name ip-acl-num prefix-list [list-name]>] command deletes match condition.</p>
<p>match metric <metric-val > no match metric [<metric-val >]</p>	<p>Match the routing metric value; The no match metric [<metric-val >] command deletes match condition.</p>
<p>match origin <egp igp incomplete > no match origin [<egp igp incomplete >]</p>	<p>Match the route origin; The no match origin [<egp igp incomplete >] command deletes match condition.</p>
<p>match route-type external <type-1 type-2 > no match route-type external [<type-1 type-2 >]</p>	<p>Match the route type; The no match route-type external [<type-1 type-2 >] command deletes match condition.</p>
<p>match tag <tag-val > no match tag [<tag-val >]</p>	<p>Match the route tag; The no match tag [<tag-val >] command deletes match condition.</p>

3. Define the set clause in route-map

Command	Explanation
Route-map configuration mode	
set aggregator as <as-number> <ip_addr> no set aggregator as [<as-number> <ip_addr>]	Distribute an AS No. for BGP aggregator; The no command deletes the configuration
set as-path prepend <as-num> no set as-path prepend [<as-num>]	Add a specified AS No. before the BGP routing messages as-path series; The no command deletes the configuration
set atomic-aggregate no set atomic-aggregate	Configure the BGP atomic aggregate property; The no command deletes the configuration
set comm-list <community-list-name community-list-num > delete no set comm-list <community-list-name community-list-num > delete	Delete BGP community list value; The no command deletes the configuration
set community [AA:NN] [internet] [local-AS] [no-advertise] [no-export] [none] [additive] no set community [AA:NN] [internet] [local-AS] [no-advertise] [no-export] [none] [additive]	Configure BGP community list value; The no command deletes the configuration
set extcommunity <rt soo> <AA:NN> no set extcommunity <rt soo> [<AA:NN>]	Configure BGP extended community list property; The no command deletes the configuration
set ip next-hop <ip_addr> no set ip next-hop [<ip_addr>]	Set next-hop IP address; The no command deletes the configuration
set local-preference <pre_val> no set local-preference [<pre_val>]	Set local preference; The no command deletes the configuration
set metric < +/- metric_val metric_val> no set metric [+/- metric_val metric_val]	Set routing metric value; The no command deletes the configuration
set metric-type <type-1 type-2> no set metric-type [<type-1 type-2>]	Set OSPF metric type; The no command deletes the configuration
set origin <egp igp incomplete > no set origin [<egp igp incomplete >]	Set BGP routing origin; The no command deletes the configuration

set originator-id <ip_addr> no set originator-id [<ip_addr>]	Set routing originator ID; The no command deletes the configuration
set tag <tag_val> no set tag [<tag_val>]	Set OSPF routing tag value; The no command deletes the configuration
set vpnv4 next-hop <ip_addr> no set vpnv4 next-hop [<ip_addr>]	Set BGP VPNv4 next-hop address; the no command deletes the configuration
set weight <weight_val> no set weight [<weight_val>]	Set BGP routing weight; The no command deletes the configuration

4. Define address prefix list

Command	Explanation
Global mode	
ip prefix-list <list_name> description <description> no ip prefix-list <list_name> description	Describe the prefix list; The no ip prefix-list <list_name> description command deletes the configuration.
ip prefix-list <list_name> [seq <sequence_number>] <deny permit> < any ip_addr/mask_length [ge min_prefix_len] [le max_prefix_len]> no ip prefix-list <list_name> [seq <sequence_number>] <deny permit> < any ip_addr/mask_length [ge min_prefix_len] [le max_prefix_len]>	Set the prefix list; The no ip prefix-list <list_name> [seq <sequence_number>] [<deny permit> < any ip_addr/mask_length [ge min_prefix_len] [le max_prefix_len]> command deletes the configuration.

33.2.3 Configuration Examples

The figure below shows a network consisting of four Layer 3 switches. This example demonstrates how to set the BGP as-path properties through route-map. BGP protocol is applied among the Layer 3 switches. As for switchC, the network 192.68.11.0/24 can be reached through two paths in which one is AS-PATH 1 by IBGP (going through SwitchD), the other one is AS-PATH 2 by EBGP (going through SwitchB). BGP selects the shortest path, so AS-PATH 1 is the preferred path. If the path 2 is wished, which is through EBGP path, we can add two extra AS path numbers into the AS-PATH messages from SwitchA to SwitchD so as to change the determination SwitchC take to 192.68.11.0/24.

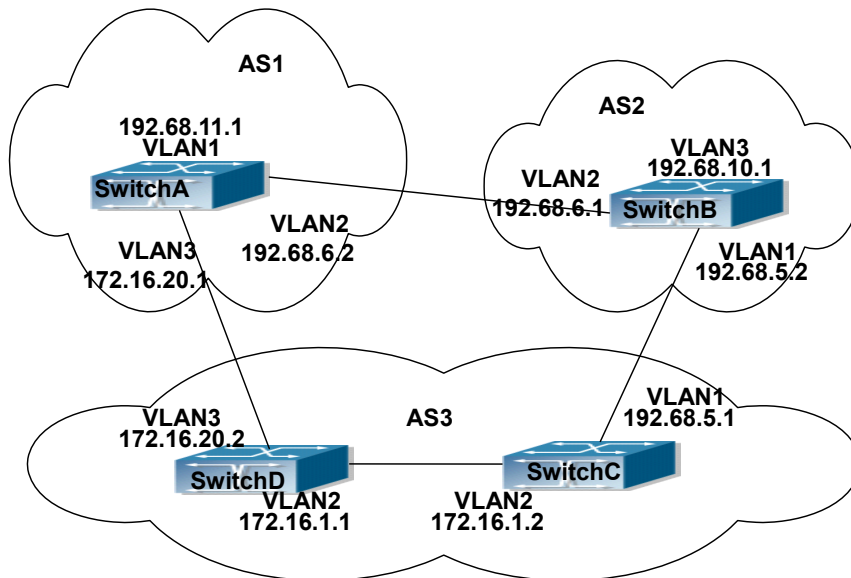

Figure 33-2-1 Policy routing Configuration

Configuration procedure: (only SwitchA is listed, configurations for other switches are omitted.)

The configuration of Layer 3 switchA:

```
SwitchA#config
SwitchA(config) #router bgp 1
SwitchA(config-router)#network 192.68.11.0 mask 255.255.255.0
SwitchA(config-router)#neighbor 172.16.20.2 remote-as 3
SwitchA(config-router)#neighbor 172.16.20.2 route-map AddAsNumbers out
SwitchA(config-router)#neighbor 192.68.6.1 remote-as 2
SwitchA(config-router)#exit
SwitchA(config)#route-map AddAsNumbers permit 10
SwitchA(config-route-map)#set as-path prepend 1 1
```

33.2.4 Troubleshooting

FAQ: The routing protocol could not achieve the routing messages study under normal protocol running state

Troubleshooting: check the following errors:

- Each node of route-map should at least has one node in permitted match mode. When the route map is used in routing messages filtering, the routing messages will be considered not passing the routing messages filtering if certain routing messages does not pass the filtering of any nodes. When all nodes are set to deny mode, all routing messages will not pass the filtering in this route-map.
- Items in address prefix list should at least have one item set in permit mode. The deny mode items can be defined first to fast remove the unmatched routing messages, however, if all the items are set to deny mode, any route will not be able to pass the filtering of this address prefix list. We can define a permit 0.0.0.0/0 le 32 item after several deny mode items are defined so to permit all other routing messages to pass through. Only default route will be matched in less-equal 32 not specified.

Chapter 34 Static Route

34.1 Introduction to Static Route

As mentioned earlier, the static route is the manually specified path to a network or a host. Static route is simple and consistent, and can prevent illegal route modification, and is convenient for load balance and route backup. However, it also has its own defects. Static route, as its name indicates, is static, it won't modify the route automatically on network failure, and manual configuration is required on such occasions, therefore it is not suitable for mid and large-scale networks.

Static route is mainly used in the following two conditions: 1) in stable networks to reduce load of route selection and routing data streams. For example, static route can be used in route to STUB network. 2) For route backup, configure static route in the backup line, with a lower priority than the main line.

Static route and dynamic route can coexist; Layer3 switch will choose the route with the highest priority according to the priority of routing protocols. At the same time, static route can be introduced (redistribute) in dynamic route, and change the priority of the static route introduced as required.

34.2 Introduction to Default Route

Default route is a kind of static route, which is used only when no matching route is found. In the route table, default route is indicated by a destination address of 0.0.0.0 and a network mask of 0.0.0.0, too. If the route table does not have the destination of a packet and has no default route configured, the packet will be discarded, and an ICMP packet will be sent to the source address indicate the destination address or network is unreachable.

34.3 Static Route Configuration Task List

1. Static route configuration

1. Static route configuration

Command	Explanation
Global mode	
<code>ip route {<ip-prefix> <mask> <ip-prefix>/<prefix-length>} {<gateway-address> <gateway-interface>} [<distance>]</code> <code>no ip route {<ip-prefix> <mask> <ip-prefix>/<prefix-length>} [<gateway-address> <gateway-interface>} [<distance>]</code>	Set static routing; the <code>no ip route {<ip-prefix> <mask> <ip-prefix>/<prefix-length>} [<gateway-address> <gateway-interface>} [<distance>]</code> command deletes a static route entry

34.4 Static Route Configuration Examples

The figure shown below is a simple network consisting of three Layer3 switches, the network mask for all switches and PC is 255.255.255.0. PC-A and PC-C are connected via the static route set in Switch and SwitchC; PC3 and PC-B are connected via the static route set in Switch to SwitchB; PC-B and PC-C is connected via the default route set in SwitchB.

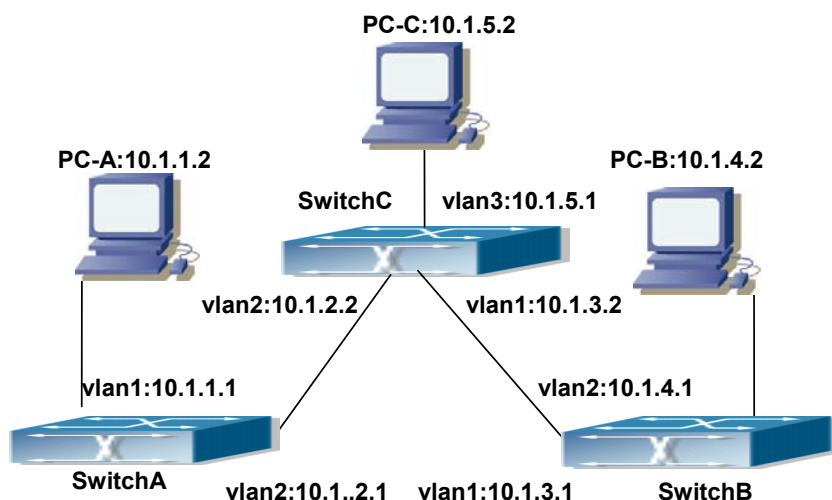

Figure 34-4-1 Static Route Configurations

Configuration steps:

Configuration of Layer3 SwitchA

```
XGS3-42000R#config
XGS3-42000R(config)#ip route 10.1.5.0 255.255.255.0 10.1.2.2
Configuration of Layer3 SwitchC
XGS3-42000R#config
Next hop use the partner IP address
XGS3-42000R(config)#ip route 10.1.1.0 255.255.255.0 10.1.2.1
Next hop use the partner IP address
XGS3-42000R(config)#ip route 10.1.4.0 255.255.255.0 10.1.3.1
Configuration of Layer3 SwitchB
XGS3-42000R#config
XGS3-42000R(config)#ip route 0.0.0.0 0.0.0.0 10.1.3.2
```

In this way, ping connectivity can be established between PC-A and PC-C, and PC-B and PC-C.

Chapter 35 RIP

35.1 Introduction to RIP

RIP is first introduced in ARPANET, this is a protocol dedicated to small, simple networks. RIP is a distance vector routing protocol based on the Bellman-Ford algorithm. Network devices running vector routing protocol send two kind of information to the neighboring devices regularly:

- Number of hops to reach the destination network, or metrics to use or number of networks to pass.
- What is the next hop, or the director (vector) to use to reach the destination network.

The distance vector Layer 3 switch send all their route selecting tables to the neighbor Layer3 switches at regular interval. A Layer3 switch will build their own route selecting information table based on the information received from the neighbor Layer3 switches. Then, it will send this information to its own neighbor Layer3 switches. As a result, the route selection table is built on second hand information, route beyond 15 hops will be deemed as unreachable.

RIP protocol is an optional routing protocol based on UDP. Hosts using RIP send and receive packets on UDP port 520. All Layer3 switches running RIP send their route table to all neighbor Layer3 switches every 30 seconds for update. If no information from the partner is received in 180 seconds, then the device is deemed to have failed and the network connected to that device is considered to be unreachable. However, the route of that Layer3 switch will be kept in the route table for another 120 seconds before deletion.

As Layer3 switches running RIP built route table with second hand information, infinite count may occur. For a network running RIP routing protocol, when an RIP route becomes unreachable, the neighboring RIP Layer3 switch will not send route update packets at once, instead, it waits until the update interval timeout (every 30 seconds) and sends the update packets containing that route. If before it receives the updated packet, its neighbors send packets containing the information about the failed neighbor, “infinite count” will be resulted. In other words, the route of unreachable Layer3 switch will be selected with the metrics increasing progressively. This greatly affects the route selection and route aggregation time.

To prevent “infinite count”, RIP provides mechanism such as “split horizon” and “triggered update” to solve route loop. “Split horizon” is done by avoiding sending to a gateway routes leaned from that gateway. There are two split horizon methods: “simple split horizon” and “poison reverse split horizon”. Simple split horizon deletes from the route to be sent to the neighbor gateways the routes learnt from the neighbor gateways; poison reverse split horizon not only deletes the abovementioned routes, but set the costs of those routes to infinite. “Triggering update” mechanism defines whenever route metric changed by the gateway, the gateway advertise the update packets immediately, regardless of the 30 second update timer status.

There two versions of RIP, version 1 and version 2. RFC1058 introduces RIP-I protocol, RFC2453 introduces RIP-II, which is compatible with RFC1723 and RFC1388. RIP-I updates packets by packets broadcast, subnet mask and authentication is not supported. Some fields in the RIP-I packets are not used and are required to be all 0's; for this reason, such all 0's fields should be checked when using RIP-I, the RIP-I packets should be discarded if such fields are non-zero. RIP-II is a more improved version than RIP-I. RIP-II sends route update

packets by multicast packets (multicast address is 224.0.0.9). Subnet mask field and RIP authentication field (simple plaintext password and MD5 password authentication are supported), and support variable length subnet mask. RIP-II used some of the zero field of RIP-I and require no zero field verification. switch send RIP-II packets in multicast by default, both RIP-I and RIP-II packets will be accepted.

Each Layer3 switch running RIP has a route database, which contains all route entries for reachable destination, and route table is built based on this database. When a RIP Layer3 switch sent route update packets to its neighbor devices, the complete route table is included in the packets. Therefore, in a large network, routing data to be transferred and processed for each Layer3 switch is quite large, causing degraded network performance.

Besides the above mentioned, RIP protocol allows route information discovered by the other routing protocols to be introduced to the route table.

The operation of RIP protocol is shown below:

- 1 · Enable RIP. The switch sends request packets to the neighbor Layer3 switches by broadcasting; on receiving the request, the neighbor devices reply with the packets containing their local routing information.
- 2 · The Layer3 switch modifies its local route table on receiving the reply packets and sends triggered update packets to the neighbor devices to advertise route update information. On receiving the triggered update packet, the neighbor Layer3 switches send triggered update packets to their neighbor Layer3 switches. After a sequence of triggered update packet broadcast, all Layer3 switches get and maintain the latest route information.

In addition, RIP Layer3 switches will advertise its local route table to their neighbor devices every 30 seconds. On receiving the packets, neighbor devices maintain their local route table, select the best route and advertise the updated information to their own neighbor devices, so that the updated routes are globally valid. Moreover, RIP uses a timeout mechanism for outdated route, that is, if a switch does not receive regular update packets from a neighbor within a certain interval (invalid timer interval), it considers the route from that neighbor invalid, after holding the route for a certain interval (hold-down timer interval), it will delete that route.

35.2 RIP Configuration Task List

1. Enable RIP (required)
 - (1) Enable/disable RIP module.
 - (2) Enable interface to send/receive RIP packets
2. Configure RIP protocol parameters (optional)
 - (1) Configure RIP sending mechanism
 - 1) Configure specified RIP packets transmission address
 - 2) Configure RIP interface broadcast
 - (2) Configure the RIP routing parameters
 - 1) Configure route introduction (default route metric, configure routes of the other protocols to be introduced in RIP)

- 2) Configure interface authentication mode and password
- 3) Configure the route deviation
- 4) Configure and apply route filter
- 5) Configure Split Horizon
- (3) Configure other RIP protocol parameters
 - 1) Configure the managing distance of RIP route
 - 2) Configure the RIP route capacity limit in route table
 - 3) Configure the RIP update, timeout, hold-down and other timer.
 - 4) Configure the receiving buffer size of RIP UDP
- 3. Configure RIP-I/RIP-II switch
 - (1) Configure the RIP version to be used in all interfaces
 - (2) Configure the RIP version to send/receive in all interfaces
 - (3) Configure whether to enable RIP packets sending/receiving for interfaces
- 4. Delete the specified route in RIP route table
- 5. Configure the RIP routing aggregation
 - (1) Configure aggregation route of IPv4 route mode
 - (2) Configure aggregation route of IPv4 interface configuration mode
 - (3) Display IPv4 aggregation route information
- 6. Configure redistribution of OSPF routing to RIP
 - (1) Enable Redistribution of OSPF routing to RIP
 - (2) Display and debug the information about configuration of redistribution of OSPF routing to RIP

1. Enable RIP protocol

Applying RIP route protocol with basic configuration in switch is simple. Normally you only have to open the RIP switch and configure the segments running RIP, namely send and receive the RIP data packet by default RIP configuration. The version of data packet sending and receiving is variable when needed, allow/deny sending, receiving RIP data packet. Refer to 3.

Command	Explanation
Global Mode	
router rip no router rip	Enables RIP; the “ no router rip ” command disables RIP.
Router and address family configuration mode	
network <A.B.C.D/M ifname/vlan> no network <A.B.C.D/M ifname/vlan>	Enables the segment running RIP protocol; the no network <A.B.C.D/M ifname/vlan> command deletes the segment.

2. Configure RIP protocol parameters

(1) Configure RIP packet transmitting mechanism

- 1) Configure the RIP data packet point-transmitting
- 2) Configure the Rip broadcast

Command	Explanation
Router Configuration Mode	

neighbor <A.B.C.D> no neighbor <A.B.C.D>	Specify the IP address of the neighbor router needs point-transmitting; the no neighbor <A.B.C.D> command cancels the appointed router.
passive-interface<ifname/vlan> no passive-interface<ifname/vlan >	Block the RIP broadcast on specified pot and the RIP data packet is only transmittable among Layer 3 switch configured with neighbor. The no passive-interface<ifname/vlan > command cancels the function.

(2) Configure RIP route parameters

1) Configure route introduction (default route metric, configure routes of the other protocols to be introduced in RIP)

Command	Explanation
Router Configuration Mode	
default-metric <value> no default-metric	Sets the default route metric for route to be introduced; the “ no default-metric ” command restores the default setting.
redistribute {kernel connected static ospf isis bgp} [metric<value>] [route-map<word>] no redistribute {kernel connected static ospf isis bgp} [metric<value>] [route-map<word>]	Redistribute the routes distributed in other routing protocols into the RIP data packet; the no redistribute {kernel connected static ospf isis bgp} [metric<value>] [route-map<word>] command cancels the distributed route of corresponding protocols.
default-information originate no default-information originate	Generate a default route to the RIP protocol; the no default-information originate command cancels the feature.

2) Configure interface authentication mode and password

Command	Explanation
Interface configuration mode	
ip rip authentication mode { text md5} no ip rip authentication mode [text md5]	Sets the authentication method; the no ip rip authentication mode [text md5] command cancels the authentication action.
ip rip authentication string <text> no ip rip authentication string	Sets the authentication key; the no ip rip authentication string command means no key is needed.
ip rip authentication key-chain <name-of-chain> no ip rip authentication key-chain [<name-of-chain>]	Sets the key chain used in authentication, the no ip rip authentication key-chain [<name-of-chain>] command means the key chain is not used.

ip rip authentication cisco-compatible no ip rip authentication cisco-compatible	After configure this command, configure MD5 authentication, then can receive RIP packet of cisco, the no command restores the default configuration.
Global mode	
key chain <name-of-chain> no key chain < name-of-chain >	Enter keychain mode, and configure a key chain, the no key chain < name-of-chain > command deletes the key chain.
Keychain mode	
key <keyid> no key <keyid>	Enter the keychain-key mode and configure a key of the keychain; the no key <keyid> command deletes one key.
Keychain-key mode	
key-string <text> no key-string <text>	Configure the password used by the key, the no key-string <text> command deletes the password.
accept-lifetime <start-time> {<end-time> duration<seconds> infinite} no accept-lifetime	Configure a key on the key chain and accept it as an authorized time; the no accept-lifetime command deletes it.
send-lifetime <start-time> {<end-time> duration<seconds> infinite} no send-lifetime	Configure the transmitting period of a key on the key chain; the no send-lifetime command deletes the send-lifetime.

3) Configure the route deviation

Command	Explanation
Router configuration mode	
offset-list <access-list-number access-list-name> {in out } <number> [<ifname>] no offset-list <access-list-number access-list-name> {in out }<number >[<ifname>]	Configure that provide a deviation value to the route metric value when the port sends or receives RIP data packet; the no offset-list <access-list-number access-list-name> {in out } <number >[<ifname>] command removes the deviation table.

4) Configure and apply the route filtering

Command	Explanation
Router configuration mode	
distribute-list {< access-list-number /access-list-name > prefix<prefix-list-name>}{in out} [<ifname>] no distribute-list {< access-list-number /access-list-name > prefix<prefix-list-name>}{in out} [<ifname>]	Configure and apply the access table and prefix table to filter the routes. The no distribute-list {< access-list-number /access-list-name> prefix<prefix-list-name>}{in out} [<ifname>] command means do not use the access table and prefix table.

5) Configure the split horizon

Command	Explanation
Interface configuration mode	
ip rip split-horizon [poisoned] no ip rip split-horizon	Configure that take the split horizon when the port sends data packets; poisoned for poison reverse the no ip rip split-horizon command cancels the split horizon.

(3) Configure other RIP protocol parameters

- 1) Configure RIP routing priority
- 2) Configure the RIP route capacity limit in route table
- 3) Configure timer for RIP update, timeout and hold-down
- 4) Configure RIP UDP receiving buffer size

Command	Explanation
Router configuration mode	
distance <number> [<A.B.C.D/M>] [<access-list-name/access-list-number >] no distance [<A.B.C.D/M>]	Specify the route administratively distance of RIP protocol; the no distance [<A.B.C.D/M>] command restore the default value 120.
maximum-prefix <maximum-prefix>[<threshold>] no maximum-prefix <maximum-prefix > no maximum-prefix	Configure the maximum of RIP route; the no maximum-prefix <maximum-prefix > no maximum-prefix command cancels the limit.
timers basic <update> <invalid> <garbage> no timers basic	Adjust the update, timeout and garbage collection time, the no timers basic command restores the default configuration.
recv-buffer-size <size> no recv-buffer-size	The command configures the UDP receiving buffer size of the RIP; the no recv-buffer-size command restores the system default values.

3. Configure RIP-I/RIP-II toggling

(1) Configure the RIP version to be used in all ports

Command	Explanation
RIP configuration mode	
version { 1 2 } no version	Configure the versions of all the RIP data packets transmitted/received by the Layer 3 switch port sending/receiving the no version command restores the default configuration, version 2.

(2) Configure the RIP version to send/receive in all ports.

(3) Configure whether to enable RIP packets sending/receiving for ports

Command	Explanation
Interface configuration mode	
ip rip send version { 1 1-compatible 2 } no ip rip send version	Sets the version of RIP packets to send on all ports; the no ip rip send version command set the version to the one configured by the version command.
ip rip receive version {1 2 } no ip rip receive version	Sets the version of RIP packets to receive on all ports; the no action of this command set the version to the one configured by the version command.
ip rip receive-packet no ip rip receive-packet	Enables receiving RIP packets on the interface; the no ip rip receive-packet command close data receiving on this port.
ip rip send-packet no ip rip send-packet	Enables sending RIP packets on the interface; the “ no ip rip send-packet ” command disables sending RIP packets on the interface.

4. Delete the specified route in RIP route table

Command	Explanation
Admin Mode	
clear ip rip route {<A.B.C.D/M> kernel static connected r ip ospf isis bgp all}	The command deletes a specified route from the RIP route table.

5. Configure the RIP routing aggregation

(1) Configure IPv4 aggregation route globally

Command	Explanation
Router Configuration Mode	
ip rip aggregate-address A.B.C.D/M no ip rip aggregate-address A.B.C.D/M	To configure or delete IPv4 aggregation route globally.

(2) Configure IPv4 aggregation route on interface

Command	Explanation
Interface Configuration Mode	
ip rip aggregate-address A.B.C.D/M no ip rip aggregate-address A.B.C.D/M	To configure or delete IPv4 aggregation route on interface.

(3) Display IPv4 aggregation route information

Command	Explanation
Admin Mode and Configuration Mode	
show ip rip aggregate	To display aggregation route information.

6. Configure redistribution of OSPF routing to RIP

(1) Enable Redistribution of OSPF routing to RIP

Command	Explanation
Router RIP Configuration Mode	
redistribute ospf [<process-id>] [metric <value>] [route-map <word>] no redistribute ospf [<process-id>]	To enable or disable the redistribution of OSPF routing to RIP.

(2) Display and debug the information about configuration of redistribution of OSPF routing to RIP

Command	Explanation
Admin Mode and Configuration Mode	
show ip rip redistribute	To display the information about configuration of redistribute from other routing.
Admin Mode	
debug rip redistribute message send no debug rip redistribute message send debug rip redistribute route receive no debug rip redistribute route receive	To enable or disable debugging messages sent by RIP for redistribution of OSPF routing. To enable or disable debugging messages received from NSM.

35.3 RIP Examples

35.3.1 Typical RIP Examples

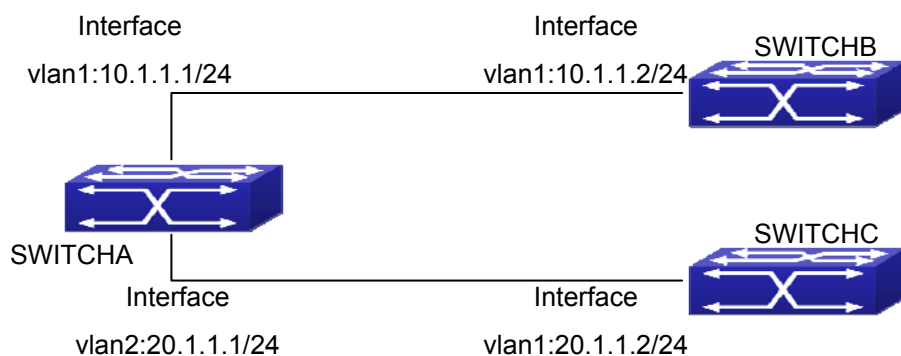

Figure 35-3-1 RIP example

In the figure shown above, a network consists of three Layer 3 switches, in which SwitchA connected with SwitchB and SwitchC, and RIP routing protocol is running in all of the three switches. SwitchA (interface vlan1 : 10.1.1.1,interface vlan2 : 20.1.1.1) exchanges Layer 3 switch update messages only with SwitchB (interface vlan1 : 10.1.1.2) , but not with SwitchC (interface vlan 2: 20.1.1.2) .

SwitchA, SwitchB, SwitchC configurations are as follows:

a) Layer 3 SwitchA :

Configure the IP address of interface vlan 1

```
SwitchA#config
SwitchA(config)# interface vlan 1
SwitchA(Config-if-Vlan1)# ip address 10.1.1.1 255.255.255.0
SwitchA(config-if-Vlan1)#
Configure the IP address of interface vlan 2
SwitchA(config)# vlan 2
SwitchA(Config-Vlan2)# switchport interface ethernet 1/2
Set the port Ethernet1/1 access vlan 2 successfully
SwitchA(Config-Vlan2)# exit
SwitchA(config)# interface vlan 2
SwitchA(Config-if-Vlan2)# ip address 20.1.1.1 255.255.255.0
Initiate RIP protocol and configure the RIP segments
SwitchA(config)#router rip
SwitchA(config-router)#network vlan 1
SwitchA(config-router)#network vlan 2
SwitchA(config-router)#exit
Configure that the interface vlan 2 do not transmit RIP messages to SwitchC
SwitchA(config)#router rip
SwitchA(config-router)#passive-interface vlan 2
SwitchA(config-router)#exit
SwitchA(config) #
```

b) Layer 3 SwitchB

Configure the IP address of interface vlan 1

```
SwitchB#config
SwitchB(config)# interface vlan 1
SwitchB(Config-if-Vlan1)# ip address 10.1.1.2 255.255.255.0
SwitchB(Config-if-Vlan1)exit
Initiate RIP protocol and configure the RIP segments
SwitchB(config)#router rip
SwitchB(config-router)#network vlan 1
SwitchB(config-router)#exit
```

c) Layer 3 SwitchC

Configure the IP address of interface vlan 1

```
SwitchC#config
SwitchC(config)# interface vlan 1
Configure the IP address of interface vlan 1
SwitchC(Config-if-Vlan1)# ip address 20.1.1.2 255.255.255.0
SwitchC(Config-if-Vlan1)#exit
Initiate RIP protocol and configure the RIP segments
SwitchC(config)#router rip
SwitchC(config-router)#network vlan 1
SwitchC(config-router)#exit
```

35.3.2 Typical Examples of RIP aggregation function

The application topology is as follows:

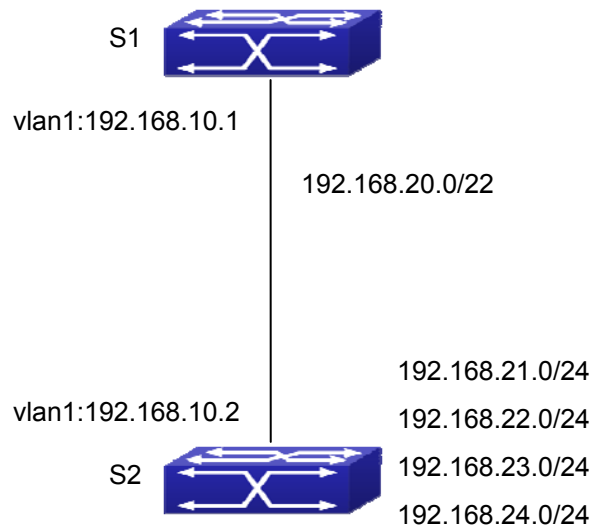

Figure 35-3-2 Typical application of RIP aggregation

As the above network topology, S2 is connected to S1 through interface vlan1, there are other 4 subnet routers of S2, which are 192.168.21.0/24, 192.168.22.0/24, 192.168.23.0/24, 192.168.24.0/24. S2 supports route aggregation, and to configure aggregation route 192.168.20.0/22 in interface vlan1 of S2, after that, sending router messages to S1 through vlan1, and put the four subnet routers aggregated to one router as 192.168.20.0/22, and send to S1, and not send subnet to neighbor. It can reduce the router table of S1, save the memory.

S1 configuration list:

```
S1(config)#router rip
S1(config-router) #network vlan 1
S2 configuration list:
S2(config)#router rip
```

```
S2(config-router) #network vlan 1
S2(config-router) #exit
S2(config)#in vlan 1
S2(Config-if-Vlan1)# ip rip agg 192.168.20.0/22
```

35.4 RIP Troubleshooting

The RIP protocol may not be working properly due to errors such as physical connection, configuration error when configuring and using the RIP protocol. So users should pay attention to following:

- Enabling dot1q-tunnel on Trunk port will make the tag of the data packet unpredictable which is not required in the application. So it is not recommended to enable dot1q-tunnel on Trunk port except the VLAN-translation is in operation .
- Configuring in port-channel is not supported.
- Enabled with STP/MSTP is not supported.
- Enabled with PVLAN is not supported.
- If MAC address binding cannot be enabled for a port, make sure the port is not enabling port aggregation and is not configured as a Trunk port. MAC address binding is exclusive to such configurations. If MAC address binding is to be enabled, the functions mentioned above must be disabled first.
- If a secure address is set as static address and deleted, that secure address will be unusable even though it exists. For this reason, it is recommended to avoid static address for ports enabling MAC address.
- DHCP option 82 is implemented as a sub-function module of DHCP Relay Agent. Before using it, users should make sure that the DHCP Relay Agent is configured correctly.
- DHCP option 82 needs the DHCP Relay Agent and the DHCP server cooperate to finish the task of allocating IP addresses. The DHCP server should set allocating policy correctly depending on the network topology of the DHCP Relay Agent, or, even the Relay Agent can operate normally, the allocation of addresses will fail. When there is more than one kind of Relay Agent, please pay attention to the retransmitting policy of the interface DHCP request messages.
- To implement the option 82 function of DHCP Relay Agent, the “debug dhcp relay packet” command can be used during the operating procedure, including adding the contents of option 82, the retransmitting policy adopted, the option 82 contents of the server peeled by the Relay Agent and etc., such information can help users to do troubleshooting.
- To implement the option 82 function of DHCP server, the “debug ip dhcp server packet” command can be used during the operating procedure to display the procedure of data packets processing of the server, including displaying the identified option 82 information of the request message and the option 82 information returned by the reply message.
- First ensure the physic connection is correct
- Second, ensure the interface and chain protocol are UP (use **show interface** command)
- Then initiate the RIP protocol (use **router rip** command) and configure the segment (use **network** command) and set RIP protocol parameter on corresponding interfaces, such as the option between RIP-I and RIP-II
- After that, one feature of RIP protocol should be noticed -- the Layer 3 switch running RIP protocol

sending route updating messages to all neighboring Layer 3 switches every 30 seconds. A Layer 3 switch is considered inaccessible if no route updating messages from the switch is received within 180 seconds, then the route to the switch will remain in the route table for 120 seconds before it is deleted. Therefore, if to delete a RIP route, this route item is assured to be deleted from route table after 300 seconds. When exchanging routing messages with CE using RIP protocol on the PE router, we should first create corresponding VPN routing/transmitting examples to associate with corresponding interfaces. Then enter the RIP address family mode configuring corresponding parameters. If the RIP routing problem remains unresolved, please use debug rip command to record the debug message in three minutes, and send them to our technical service center.

Chapter 36 RIPng

36.1 Introduction to RIPng

RIPng is first introduced in ARPANET, this is a protocol dedicated to small, simple networks. RIPng is a distance vector routing protocol based on the Bellman-Ford algorithm. Network devices running vector routing protocol send 2 kind of information to the neighboring devices regularly:

- Number of hops to reach the destination network, or metrics to use or number of networks to pass.
- What is the next hop, or the director (vector) to use to reach the destination network.

Distance vector Layer3 switches send all their route selecting tables to the neighbor Layer3 switches at regular interval. A layer3 switch will build their own route selecting information table based on the information received from the neighbor layer3 switches. Then, it will send this information to its own neighbor layer3 switches. As a result, the route selection table is built on second hand information, route beyond 15 hops will be deemed as unreachable.

RIPng is an optional routing protocol based on UDP. Hosts using RIPng send and receive packets on UDP port 521. All layer3 switches running RIP send their route table to all neighbor layer3 switches every 30 seconds for update. If no information from the partner is received in 180 seconds, then the device is deemed to have failed and the network connected to that device is considered to be unreachable. However, the route of that layer3 switch will be kept in the route table for another 120 seconds before deletion.

As Layer3 switches running RIPng build route table with second hand information, infinite count may occur. For a network running RIPng routing protocol, when a RIPng route becomes unreachable, the neighboring RIPng Layer3 switch will not send route update packets at once, instead, it waits until the update interval timeout (every 30 seconds) and sends the update packets containing that route. If before it receives the updated packet, its neighbors send packets containing the information about the failed neighbor, "infinite count" will be resulted. In other words, the route of unreachable Layer3 switch will be selected with the metrics increasing progressively. This greatly affects the route selection and route aggregation time.

To avoid "infinite count", RIPng provides mechanism such as "split horizon" and "triggered update" to solve route loop. "Split horizon" is done by avoiding sending to a gateway routes leaned from that gateway. There are two split horizon methods: "simple split horizon" and "poison reverse split horizon". Simple split horizon deletes from the route to be sent to the neighbor gateways the routes learnt from the neighbor gateways; poison reverse split horizon not only deletes the abovementioned routes, but set the costs of those routes to infinite. "Triggering update" mechanism defines whenever route metric changed by the gateway, the gateway advertise the update packets immediately other than wait for the 30 sec timer.

So far the RIPng protocol has got only one version---Version1: RIPng protocol is introduced in RFC 2080. RIPng transmits updating data packet by multicast data packet (multicast address FF02::9)
Each Layer3 switch running RIPng has a route database, which contains all route entries for reachable destination, and route table is built based on this database. When a RIPng Layer3 switch sent route update

packets to its neighbor devices, the complete route table is included in the packets. Therefore, in a large network, routing data to be transferred and processed for each Layer3 switch is quite large, causing degraded network performance.

Besides the above mentioned, RIPng protocol allows IPv6 route information discovered by the other routing protocols to be introduced to the route table.

The operation of RIPng protocol is shown below:

- 1 · Enable RIPng The switch sends request packets to the neighbor Layer3 switches by broadcasting; on receiving the request, the neighbor devices reply with the packets containing their local routing information.
- 2 · The Layer3 switch modifies its local route table on receiving the reply packets and sends triggered update packets to the neighbor devices to advertise route update information. On receiving the triggered update packet, the neighbor lay3 switches send triggered update packets to their neighbor lay3 switches. After a sequence of triggered update packet broadcast, all Layer3 switches get and maintain the latest route information.

In addition, RIPng Layer3 switches will advertise its local route table to their neighbor devices every 30 seconds. On receiving the packets, neighbor devices maintain their local route table, select the best route and advertise the updated information to their own neighbor devices, so that the updated routes are globally valid. Moreover, RIP uses a timeout mechanism for outdated route, that is, if a switch does not receive regular update packets from a neighbor within a certain interval (invalid timer interval), it considers the route from that neighbor invalid, after holding the route fro a certain interval (garbage collect timer interval), it will delete that route.

As a result of continuous development of IPv6 network, it has the network environment of nonsupport IPv6 sometimes, so it needs to do the IPv6 operation by tunnel. Therefore, our RIPng supports configuration on configure tunnel, and passes through nonsupport IPv6 network by unicast packet of IPv4 encapsulation.

36.2 RIPng Configuration Task List

RIPng Configuration Task List:

1. Enable RIPng protocol (required)
 - (1) Enable/disable RIPng protocol
 - (2) Configure the interfaces running RIPng protocol
2. Configure RIPng protocol parameters (optional)
 - (1) Configure RIPng sending mechanism
 - 1) Configure specified RIPng packets transmission address
 - (2) Configure RIP routing parameters
 - 1) Configure route introduction (default route metric, configure routes of the other protocols to be introduced in RIPng)
 - 2) Configure the route deviation
 - 3) Configure and apply route filter
 - 4) Configure split horizon
3. Configure other RIPng parameters
 - (1) Configure timer for RIPng update, timeout and hold-down
4. Delete the specified route in RIPng route table

5. Configure RIPng route aggregation
 - (1) Configure aggregation route of IPv6 route mode
 - (2) Configure aggregation route of IPv6 interface configuration mode
 - (3) Display IPv6 aggregation route information
6. Configure redistribution of OSPFv3 routing to RIPng
 - (1) Enable redistribution of OSPFv3 routing to RIPng
 - (2) Display and debug the information about configuration of redistribution of OSPFv3 routing to RIPng

1. Enable RIPng protocol

Applying RIPng route protocol with basic configuration in switch is simple. Normally you only have to open the RIPng switch and configure the segments running RIPng, namely send and receive the RIPng data packet by default RIPng configuration.

Command	Explanation
Global mode	
[no] router IPv6 rip	Enables the RIPng protocol; the [no] router IPv6 rip command shuts the RIPng protocol.
Interface configuration mode	
[no] IPv6 router rip	Configure the interface to run RIPng protocol; the [no] IPv6 router rip command set the interface not run RIPng protocol.

2. Configure RIPng protocol parameters

(1) Configure RIPng sending mechanism

- 1) Configure the RIPng data packets point-transmitting

Command	Explanation
Router configuration mode	
[no] neighbor <IPv6-address> <ifname>	Specify the IPv6 Link-local address and interface of the neighboring route needs point-transmitting; the [no] neighbor <IPv6-address> <ifname> command cancels the appointed router.
[no] passive-interface <ifname>	Block the RIPng multicast on specified port and the RIPng data packet is only transmittable among Layer 3 switch configured with neighbor. the [no] passive-interface <ifname> command cancels the function.

(2) Configure RIP routing parameters

- 1) Configure route introduction (default route metric, configure routes of the other protocols to be introduced in RIP)

Command	Explanation
Router configuration mode	

default-metric <value> no default-metric	Configure the default metric of distributed route; the no default-metric command restores the default configuration 1.
[no]redistribute {kernel connected static ospf isis bgp} [metric<value>] [route-map<word>]	Redistribute the routes distributed in other route protocols into the RIPng data packet; the [no]redistribute {kernel connected static ospf isis bgp} [metric<value>] [route-map<word>] command cancels the distributed route of corresponding protocols.
[no]default-information originate	Generate a default route to the RIPng protocol; the [no] default-information originate command cancels the feature.

2) Configure the route offset

Command	Explanation
Router configuration mode	
[no] offset-list <access-list-number access-list-name> {in out} <number > [<ifname>]	Configure that provide a deviation value to the route metric value when the port sends or receives RIPng data packet; the [no] offset-list <access-list-number access-list-name> {in out} <number > [<ifname>] command removes the deviation table.

3) Configure and apply route filter and route aggregation

Command	Explanation
Router configuration mode	
[no] distribute-list {<access-list-number access-list-name> prefix<prefix-list-name>} {in out} [<ifname>]	Set to filter the route when the interface sends and receives RIPng data packets. The [no] distribute-list {< access-list-number access-list-name > prefix<prefix-list-name>} {in out} [<ifname>] command means do not set the route filter.
[no]aggregate-address <IPv6-address>	Configure route aggregation, the [no] aggregate-address <IPv6-address> command cancels the route aggregation.

4) Configure split horizon

Command	Explanation
Interface configuration mode	
IPv6 rip split-horizon [poisoned]	Configure that take the split-horizon when the port sends data packets, poisoned means with poison reverse.
no IPv6 rip split-horizon	Cancel the split-horizon.

3. Configure other RIPng protocol parameters

(1) Configure timer for RIPng update, timeout and hold-down

Command	Explanation
Router configuration mode	
timers basic <update> <invalid> <garbage> no timers basic	Adjust the renew, timeout and garbage recycle RIPng timer, the no timers basic command restore the default configuration.

4. Delete the specified route in RIPng route table

Command	Explanation
Admin Mode	
clear IPv6 rip route {<IPv6-address> kernel static connected rip ospf isis bgp all}	the command deletes a specified route from the RIP route table.

5. Configure RIPng route aggregation

(1) Configure IPv6 aggregation route globally

Command	Explanation
Router Configuration Mode	
ipv6 rip aggregate-address X:X::X:X/M no ipv6 rip aggregate-address X:X::X:X/M	To configure or delete IPv6 aggregation route globally.

(2) Configure IPv6 aggregation route on interface

Command	Explanation
Interface Configuration Mode	
ipv6 rip aggregate-address X:X::X:X/M no ipv6 rip aggregate-address X:X::X:X/M	To configure or delete IPv6 aggregation route on interface.

(3) Display IPv6 aggregation route information

Command	Explanation
Admin Mode and Configuration Mode	
show ipv6 rip aggregate	To display IPv6 aggregation route information, such as aggregation interface, metric, numbers of aggregation route, times of aggregation.

6. Configure redistribution of OSPFv3 routing to RIPng

(1) Enable redistribution of OSPFv3 routing to RIPng

Command	Explanation
Router IPv6 RIP Configuration Mode	
redistribute ospf [<process-tag>] [metric<value>] [route-map<word>] no redistribute ospf [<process-tag>]	To enable or disable redistribution of OSPFv3 routing for RIPng.

(2) Display and debug the information about configuration of redistribution of OSPFv3 routing to RIPng

Command	Explanation
Admin Configuration Mode	
show ipv6 rip redistribute	To display RIPng routing which is redistributed from other routing protocols.
Admin Mode	
debug ipv6 rip redistribute message send no debug ipv6 rip redistribute message send debug ipv6 rip redistribute route receive no debug ipv6 rip redistribute route receive	To enable or disable debugging messages sent by RIPng for redistribution of OSPFv3 routing. To enable or disable debugging route messages received from NSM.

36.3 RIPng Configuration Examples

36.3.1 Typical RIPng Examples

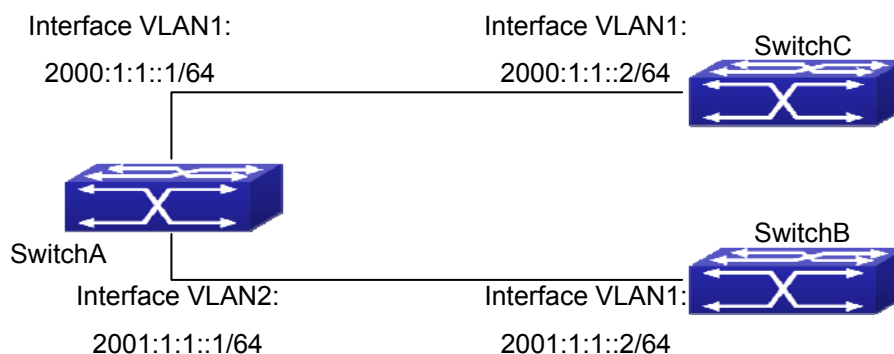

Figure 36-3-1 RIPng Example

As shown in the above figure, a network consists of three Layer 3 switches. SwitchA and SwitchB connect to

SwitchC through interface vlan1 and vlan2. All the three switches are running RIPng. Assume SwitchA (VLAN1 : 2001:1:1::1/64 and VLAN2 : 2001:1:1::1/64) exchange update information with SwitchB (VLAN1: 2001:1:1::2/64) only, update information is not exchanged between SwitchA and SwitchC (VLAN1: 2001:1:1::2/64) .

The configuration for SwitchA, SwitchB and SwitchC is shown below:

Layer 3 SwitchA

Enable RIPng protocol

```
SwitchA(config)#router IPv6 rip
SwitchA(config-router)#exit
Configure the IPv6 address in vlan1 and configure vlan1 to run RIPng
SwitchA#config
SwitchA(config)# interface Vlan1
SwitchA(config-if-Vlan1)# IPv6 address 2000:1:1::1/64
SwitchA(config-if-Vlan1)#IPv6 router rip
SwitchA(config-if-Vlan1)#exit
Configure the IPv6 address in vlan2 and configure vlan2 to run RIPng
SwitchA(config)# interface Vlan2
SwitchA(config-if-Vlan2)#IPv6 address 2001:1:1::1/64
SwitchA(config-if-Vlan2)#IPv6 router rip
SwitchA(config-if-Vlan2)#exit
```

Configure the interface vlan1 that does not send RIPng messages to SwitchC

```
SwitchA(config)#
SwitchA(config-router)#passive-interface Vlan1
SwitchA(config-router)#exit
Layer 3 SwitchB
Enable RIPng protocol
SwitchB (config)#router IPv6 rip
SwitchB (config-router-rip)#exit
```

Configure the IPv6 address and interfaces of Ethernet port vlan1 to run RIPng

```
SwitchB#config
SwitchB(config)# interface Vlan1
SwitchB(config-if)# IPv6 address 2001:1:1::2/64
SwitchB(config-if)#IPv6 router rip
SwitchB(config-if)#exit
```

Layer 3 SwitchC

Enable RIPng protocol

```
SwitchC(config)#router IPv6 rip
SwitchC(config-router-rip)#exit
```

```

Configure the IPv6 address and interfaces of Ethernet port vlan1 to run RIPng
SwitchC#config
SwitchC(config)# interface Vlan1
SwitchC(config-if)# IPv6 address 2000:1:1::2/64
SwitchC(config-if)#IPv6 router rip
SwitchC(config-if)#exit

```

36.3.2 RIPng Aggregation Route Function Typical Examples

The application topology is as follows:

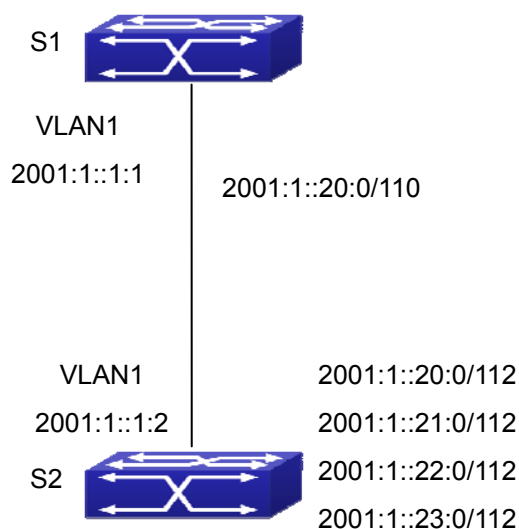

Figure 36-3-2 Typical application of RIPng aggregation

As the above network topology, S2 is connected to S1 through interface vlan1, there are other 4 subnet routers of S2, which are 2001:1::20:0/112, 2001:1::21:0/112, 2001:1::22:0/112, 2001:1::23:0/112. S2 supports route aggregation, and to configure aggregation route 2001:1::20:0/110 in interface vlan1 of S2, after that, sending router messages to S2 through vlan1, and put the four subnet routers aggregated to one router as 2001:1::20:0/110, and send to S1, and not send subnet to neighbor. It can reduce the router table of S1, save the memory.

S1 configuration list:

```

S1(config)#router ipv6 rip
S1(config-router) #network vlan 1
S2 configuration list:
S2(config)#router ipv6 rip
S2(config-router) #network vlan 1
S2(config-router) #exit
S2(config)#in vlan 1
S2(Config-if-Vlan1)# ipv6 rip agg 2001:1::20:0/110

```

36.4 RIPng Troubleshooting

The RIPng protocol may not be working properly due to errors such as physical connection, and configuration error when configuring and using the RIPng protocol. So users should pay attention to the following:

- First ensure the physical connection is correct and the IP Forwarding command is open
- Second, ensure the interface and link layer protocol are UP (use **show interface** command)
- Then initiate the RIPng protocol (use **router IPv6 rip** command) and configure the port (use **IPv6 router** command), and set RIPng protocol parameter on corresponding interfaces.
- After that, an RIPng protocol feature should be noticed -- the Layer 3 switch running RIPng transmits the route updating messages every 30 seconds. A Layer 3 switch is considered inaccessible if no route updating messages from the switch is received within 180 seconds, then the route to the switch will remain in the route table for 120 seconds before it is deleted. Therefore, if to delete an RIPng route, this route item is assured to be deleted from route table after 300 seconds.

Chapter 37 OSPF

37.1 Introduction to OSPF

OSPF is abbreviation for Open Shortest Path First. It is an interior dynamic routing protocol for autonomous system based on link-state. The protocol creates a link-state database by exchanging link-states among Layer3 switches, and then uses the Shortest Path First algorithm to generate a route table basing on that database.

Autonomous system (AS) is a self-managed interconnected network. In large networks, such as the Internet, a giant interconnected network is broken down to autonomous systems. Big enterprise networks connecting to the Internet are independent AS, since the other hosts on the Internet are not managed by those AS and they don't share interior routing information with the Layer3 switches on the Internet.

Each link-state Layer3 switch can provide information about the topology with its neighboring Layer3 switches.

- The network segment (link) connecting to the Layer3 switch
- State of the connecting link

Link-state information is flooded throughout the network so that all Layer3 switches can get firsthand information. Link-state Layer3 switches will not broadcast all information contained in their route tables; instead, they only send changed link-state information. Link-state Layer3 switches establish neighborhood by sending "HELLO" to their neighbors, then link-state advertisements (LSA) will be sent among neighboring Layer3 switches. Neighboring Layer3 switch copy the LSA to their routing table and transfer the information to the rest part of the network. This process is referred to as "flooding". In this way, firsthand information is sent throughout the network to provide accurate map for creating and updating routes in the network. Link-state routing protocols use cost instead of hops to decide the route. Cost is assigned automatically or manually. According to the algorithm in link-state protocol, cost can be used to calculate the hop number for packets to pass, link bandwidth, and current load of the link. The administrator can even add weight for better assessment of the link-state.

- 1) When a link-state Layer3 switch enters a link-state interconnected network, it sends a HELLO packet to get to know its neighbors and establish neighborhood.
- 2) The neighbors respond with information about the links they are connecting and the related costs.
- 3) The originate Layer3 switch uses this information to build its own routing table
- 4) Then, as part of the regular update, Layer3 switch send link-state advertisement (LSA) packets to its neighboring Layer3 switches. The LSA include links and related costs of that Layer3 switch.
- 5) Each neighboring Layer3 switch copies the LSA packet and passes it to the next neighbor (i.e. flooding).
- 6) Since routing database is not recalculated before Layer3 switch forwards LSA flooding, the converging time is greatly reduced.

One major advantage of link-state routing protocols is the fact that infinite counting is impossible. This is because the way link-state routing protocols builds up their routing table. The second advantage is that converging in a link-state interconnected network is very fast. Once the routing topology changes, updates will

be flooded throughout the network very soon. Those advantages release some Layer3 switch resources, as the process ability and bandwidth used by bad route information are minor.

The features of OSPF protocol include the following: OSPF supports networks of various scales, several hundreds of Layer3 switches can be supported in an OSPF network. Routing topology changes can be quickly found and updating LSAs can be sent immediately, so that routes converge quickly. Link-state information is used in shortest path algorithm for route calculation, eliminating loop route. OSPF divides the autonomous system into areas, reducing database size, bandwidth occupation and calculation load. (According to the position of Layer3 switches in the autonomous system, they can be grouped as internal area switches, area border switches, AS border switches and backbone switches). OSPF supports load balance and multiple routes to the same destination of equal costs. OSPF supports 4 level routing mechanisms (process routing according to the order of intra-area path, inter-area path, type 1 external path and type 2 external path). OSPF supports IP subnet and redistribution of routes from the other routing protocols, and interface-based packet verification. OSPF supports sending packets in multicast.

Each OSPF Layer3 switch maintains a database describing the topology of the whole autonomous system. Each Layer3 switch gathers the local status information, such as available interface, reachable neighbors, and sends link-state advertisement (sending out link-state information) to exchange link-state information with other OSPF Layer3 switches to form a link-state database describing the whole autonomous system. Each Layer3 switch builds a shortest path tree rooted by itself according to the link-state database, this tree provides the routes to all nodes in an autonomous system. If two or more Layer3 switches exist (i.e. multi-access network), "designated Layer3 switch" and "backup designated Layer3 switch" will be selected. Designated Layer3 switch is responsible for spreading link-state of the network. This concept helps reducing the traffic among the Layer3 switches in multi-access network.

OSPF protocol requires the autonomous system to be divided into areas. That is to divide the autonomous system into 0 area (backbone area) and non-0 areas. Routing information between areas are further abstracted and summarized to reduce the bandwidth required in the network. OSPF uses four different kinds of routes; they are intra-area route, inter-area route, type 1 external route and type 2 external route, in the order of highest priority to lowest. The route inside an area and between areas describes the internal network structure of an autonomous system, while external routes describe how to select the routing information to destination outside the autonomous system. The first type of exterior route corresponds to the information introduced by OSPF from the other interior routing protocols, the costs of those routes are comparable with the costs of OSPF routes; the second type of exterior route corresponds to the information introduced by OSPF from the other exterior routing protocols, but the costs of those routes are far greater than that of OSPF routes, so OSPF route cost is ignored when calculating route costs.

OSPF areas are centered with the Backbone area, identified as Area 0, all the other areas must be connected to Area 0 logically, and Area 0 must be continuous. For this reason, the concept of virtual link is introduced to the backbone area, so that physically separated areas still have logical connectivity to the backbone area. The configurations of all the Layer3 switches in the same area must be the same.

In conclusion, LSA can only be transferred between neighboring Layer3 switches, OSPF protocol includes 5 types of LSA: router LSA, network LSA, network summary LSA to the other areas, ASBR summary LSA and

AS external LSA. They can also be called type1 LSA, type2 LSA, type3 LSA, type4 LSA, and type5 LSA. Router LSA is generated by each Layer3 switch inside an OSPF area, and is sent to all the other neighboring Layer3 switches in the same area; network LSA is generated by the designated Layer3 switch in the OSPF area of multi-access network, and is sent to all other neighboring Layer3 switches in this area. (In order to reduce traffic on Layer3 switches in the multi-access network, “designated Layer3 switch” and “backup designated Layer3 switch” should be selected in the multi-access network, and the network link-state is broadcasted by the designated Layer3 switch); network summary LSA is generated by border switches in an OSPF area , and is transferred among area border Layer3 switches; AS external LSA is generated by Layer3 switches on external border of AS, and is transferred throughout the AS.

As to autonomous systems mainly advertises exterior link-state, OSPF allow some areas to be configured as STUB areas to reduce the size of the topology database. Type4 LSA (ASBR summary LSA) and type5 LSA (AS external LSA) are not allowed to flood into/through STUB areas. STUB areas must use the default routes, the Layer3 switches on STUB area edge advertise the default routes to STUB areas by type 3 summary LSA, those default routes only floods inside STUB area and will not get out of STUB area. Each STUB area has a corresponding default route, the route from a STUB area to AS exterior destination must rely on the default route of that area.

The following simply outlines the route calculation process of OSPF protocol:

- 1) Each OSPF-enabled Layer3 switch maintains a database (LS database) describing the link-state of the topology structure of the whole autonomous system. Each Layer3 switch generates a link-state advertisement according to its surrounding network topology structure (router LSA), and sends the LSA to other Layer3 switches through link-state update (LSU) packets. Thus each Layer3 switches receives LSAs from other Layer3 switches, and all LSAs are combined to the link-state database.
- 2) Since a LSA is the description of the network topology structure around a Layer3 switch, the LS database is the description of the network topology structure of the whole network. The Layer3 switches can easily create a weighted vector map according to the LS database. Obviously, all Layer3 switches in the same autonomous system will have the same network topology map.
- 3) Each Layer3 switch uses the shortest path first (SPF) algorithm to calculate a tree of shortest path rooted by itself. The tree provides the route to all the nodes in the autonomous system, leaf nodes consist of the exterior route information. The exterior route can be marked by the Layer3 switch broadcast it, so that additional information about the autonomous system can be recorded. As a result, the route table of each Layer3 switch is different.

OSPF protocol is developed by the IETF, the OSPF v2 widely used now is fulfilled according to the content described in RFC2328.

37.2 OSPF Configuration Task List

The OSPF configuration for XGS3 series switches may be different from the configuration procedure to switches of the other manufacturers. It is a two-step process:

- 1、 Enable OSPF in the Global Mode;
- 2、 Configure OSPF area for the interfaces. The configuration task list is as follows:

1. Enable OSPF protocol (required)
 - (1) Enable/disable OSPF protocol (required)
 - (2) Configure the ID number of the Layer3 switch running OSPF (optional)
 - (3) Configure the network scope for running OSPF (optional)
 - (4) Configure the area for the interface (required)
2. Configure OSPF protocol parameters (optional)
 - (1) Configure OSPF packet sending mechanism parameters
 - 1) Configure OSPF packet verification
 - 2) Set the OSPF interface to receive only
 - 3) Configure the cost for sending packets from the interface
 - 4) Configure OSPF packet sending timer parameter (timer of broadcast interface sending HELLO packet to poll, timer of neighboring Layer3 switch invalid timeout, timer of LSA transmission delay and timer of LSA retransmission.
 - (2) Configure OSPF route introduction parameters
 - 1) Configure default parameters (default type, default tag value, default cost)
 - 2) Configure the routes of the other protocols to introduce to OSPF.
 - (3) Configure OSPF importing the routes of other OSPF processes
 - 1) Enable the function of OSPF importing the routes of other OSPF processes
 - 2) Display relative information
 - 3) Debug
 - (4) Configure other OSPF protocol parameters
 - 1) Configure OSPF routing protocol priority
 - 2) Configure cost for OSPF STUB area and default route
 - 3) Configure OSPF virtual link
 - 4) Configure the priority of the interface when electing designated Layer3 switch (DR).
 - 5) Configure to keep a log for OSPF adjacency changes or not
3. Disable OSPF protocol

1. Enable OSPF protocol

Basic configuration of OSPF routing protocol on switch is quite simple, usually only enabling OSPF and configuration of the OSPF area for the interface are required. The OSPF protocol parameters can use the default settings. If OSPF protocol parameters need to be modified, please refer to “2. Configure OSPF protocol parameters”.

Command	Explanation
Global Mode	
[no] router ospf [process <id>]	Enables OSPF protocol; the “ no router ospf ” command disables OSPF protocol. (required)
OSPF Protocol Configuration Mode	

router-id <router_id> no router-id	Configures the ID number for the Layer3 switch running OSPF; the “no router id” command cancels the ID number. The IP address of an interface is selected to be the Layer3 switch ID. (optional)
[no] network {<network> <mask> / <network>/<prefix>} area <area_id>	Configure certain segment to certain area, the no [no] network {<network> <mask> / <network>/<prefix>} area <area_id> command cancels this configuration. (required)

2. Configure OSPF protocol parameters

(1) Configure OSPF packet sending mechanism parameters

- 1) Configure OSPF packet verification
- 2) Set the OSPF interface to receive only
- 3) Configure the cost for sending packets from the interface

Command	Explanation
Interface Configuration Mode	
ip ospf authentication { message-digest null} no ip ospf authentication	Configures the authentication method by the interface to accept OSPF packets; the no ip ospf authentication command restores the default settings.
ip ospf authentication-key LINE no ip ospf authentication-key	Configure the key of the authentication process of OSPF data packets receiving for the interfaces; the no action of this command restores the default settings.
[no] passive-interface {IFNAME ethernet IFNAME Vlan <ID>}	Sets an interface to receive only, the no passive-interface {IFNAME ethernet IFNAME Vlan <ID>} command cancels this configuration.
ip ospf cost <cost > no ip ospf cost	Sets the cost for running OSPF on the interface; the “no ip ospf cost” command restores the default setting.

- 4) Configure OSPF packet sending timer parameter (timer of broadcast interface sending HELLO packet to poll, timer of neighboring Layer3 switch invalid timeout, timer of LSA transmission delay and timer of LSA retransmission.

Command	Explanation
Interface Configuration Mode	
ip ospf hello-interval <time> no ip ospf hello-interval	Sets interval for sending HELLO packets; the “no ip ospf hello-interval” command restores the default setting.

ip ospf dead-interval <time > no ip ospf dead-interval	Sets the interval before regarding a neighbor Layer3 switch invalid; the “ no ip ospf dead-interval ” command restores the default setting.
ip ospf transit-delay <time> no ip ospf transit-delay	Sets the delay time before sending link-state broadcast; the “ no ip ospf transmit-delay ” command restores the default setting.
ip ospf retransmit <time> no ip ospf retransmit	Sets the interval for retransmission of link-state advertisement among neighbor Layer3 switches; the “ no ip ospf retransmit ” command restores the default setting.

(2) Configure OSPF route introduction parameters

Configure the routes of the other protocols to introduce to OSPF.

Command	Explanation
OSPF Protocol Configuration Mode	
redistribute { bgp connected static rip kernel} [metric-type { 1 2 }] [tag <tag>] [metric <cost_value>] [router-map <WORD>] no redistribute { bgp connected static rip kernel }	Distribute other protocols to find routing and static routings as external routing messages the no redistribute {bgp connected static rip kernel} command cancels the distributed external messages.

(3) Configure OSPF importing the routes of other OSPF processes

1) Enable the function of OSPF importing the routes of other OSPF processes

Command	Explanation
Router OSPF Mode	
redistribute ospf [<process-id>] [metric<value>] [metric-type {1 2}][route-map<word>] no redistribute ospf [<process-id>] [metric<value>] [metric-type {1 2}][route-map<word>]	Enable or disable the function of OSPF importing the routes of other OSPF processes.

2) Display related information

Command	Explanation
Admin Mode or Configure Mode	
show ip ospf [<process-id>] redistribute	Display the configuration information of the OSPF process importing other outside routes.

3) Debug

Command	Explanation
Admin Mode	

debug ospf redistribute message send no debug ospf redistribute message send debug ospf redistribute route receive no debug ospf redistribute route receive	Enable or disable debugging of sending command from OSPF process redistributed to other OSPF process routing. Enable or disable debugging of received routing message from NSM for OSPF process.
--	---

(4) Configure other OSPF protocol parameters

- 1) Configure how to calculate OSPF SPF algorithm time
- 2) Configure the LSA limit in the OSPF link state database
- 3) Configure various OSPF parameters

Command	Explanation
OSPF Protocol Configuration Mode	
timers spf <interval> no timers spf	Configure the SPF timer of OSPF; the no timers spf command restores the default settings.
overflow database {<max-LSA> [hard soft] external <max-LSA> <recover time>} no overflow database [external <max-LSA> <recover time>]	Configure the LSA limit in current OSPF process database; the no overflow database [external <max-LSA> <recover time>] command restores the default settings.
area <id> {authentication [message-digest] default-cost <cos> filter-list {access prefix} <WORD> {in out} nssa [default-information-originate no-redistribution no-summary translator-role] range <range> stub [no-summary] virtual-link <neighbor>} no area <id> {authentication default-cost filter-list {access prefix} <WORD> {in out} nssa [default-information-originate no-redistribution no-summary translator-role] range <range> stub [no-summary] virtual-link <neighbor>}	Configure the parameters in OSPF area (STUB area, NSSA area and virtual links); the no area <id> {authentication default-cost filter-list {access prefix} <WORD> {in out} nssa [default-information-originate no-redistribution no-summary translator-role] range <range> stub [no-summary] virtual-link <neighbor>} command restores the default settings.

- 4) Configure the priority of the interface when electing designated Layer3 XGS3-42000R(DR).

Command	Explanation
Interface Configuration Mode	
ip ospf priority <priority> no ip ospf priority	Sets the priority of the interface in “designated Layer3 switch” election; the no ip ospf priority command restores the default setting.

5) Configure to keep a log for OSPF adjacency changes or not

Command	Explanation
OSPF Protocol Configuration Mode	
log-adjacency-changes detail	Configure to keep a log for OSPF adjacency changes or not.
no log-adjacency-changes detail	

3. Disable OSPF protocol

Command	Explanation
Global Mode	
no router ospf [process <id>]	Disables OSPF routing protocol.

37.3 OSPF Examples

37.3.1 Configuration Example of OSPF

Scenario 1: OSPF autonomous system.

This scenario takes an OSPF autonomous system consisting of five switches for example.

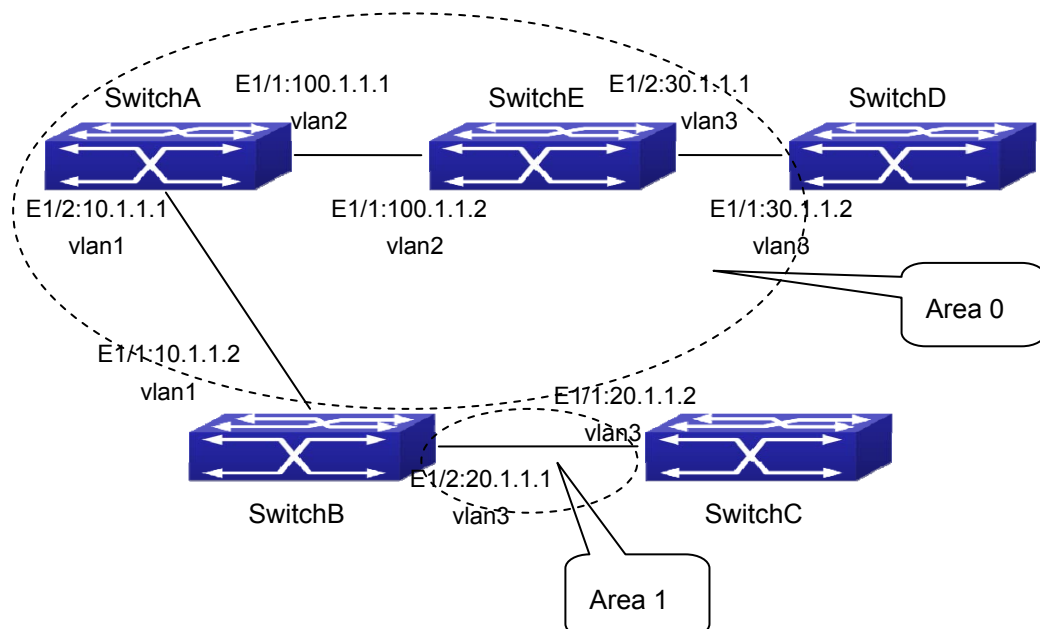

Figure 37-3-1 Network topology of OSPF autonomous system

The configuration for Layer3 Switch1 and Switch5 is shown below:

Layer 3 Switch1

Configuration of the IP address for interface vlan1

```
Switch1#config
Switch1(config)# interface vlan 1
Switch1(config-if-vlan1)# ip address 10.1.1.1 255.255.255.0
Switch1(config-if-vlan1)#exit
Configuration of the IP address for interface vlan2
Configure the IP address of interface vlan2
Switch1(config)# interface vlan 2
Switch1(config-if-vlan2)# ip address 100.1.1.1 255.255.255.0
Switch1 (config-if-vlan2)#exit
```

Enable OSPF protocol to configure the area number for interfaces vlan1 and vlan2.

```
Switch1(config)#router ospf
Switch1(config-router)#network 10.1.1.0/24 area 0
Switch1(config-router)#network 100.1.1.0/24 area 0
Switch1(config-router)#exit
Switch1(config)#exit
Switch1#
```

Layer 3 Switch2:

Configure the IP address for interfaces vlan1 and vlan2.

```
Switch2#config
Switch2(config)# interface vlan 1
Switch2(config-if-vlan1)# ip address 10.1.1.2 255.255.255.0
Switch2(config-if-vlan1)#no shutdown
Switch2(config-if-vlan1)#exit
Switch2(config)# interface vlan 3
Switch2(config-if-vlan3)# ip address 20.1.1.1 255.255.255.0
Switch2(config-if-vlan3)#no shutdown
Switch2(config-if-vlan3)#exit
```

Enable OSPF protocol to configure the OSPF area interfaces vlan1 and vlan3.

```
Switch2(config)#router ospf
Switch2(config-router)# network 10.1.1.0/24 area 0
Switch2(config-router)# network 20.1.1.0/24 area 1
Switch2(config-router)#exit
Switch2(config)#exit
Switch2#
```

Layer 3 Switch3:

Configuration of the IP address for interface vlan3.

```
Switch3#config
Switch3(config)# interface vlan 3
```

```
Switch3(config-if-vlan1)# ip address 20.1.1.2 255.255.255.0
Switch3(config-if-vlan3)#no shutdown
Switch3(config-if-vlan3)#exit
```

Initiate the OSPF protocol to configure the OSPF area to which interface vlan3 belongs

```
Switch3(config)#router ospf
Switch3(config-router)# network 20.1.1.0/24 area 1
Switch3(config-router)#exit
Switch3(config)#exit
Switch3#
```

Layer 3 Switch4:

Configuration of the IP address for interface vlan3

```
Switch4#config
Switch4(config)# interface vlan 3
Switch4(config-if-vlan3)# ip address 30.1.1.2 255.255.255.0
Switch4(config-if-vlan3)#no shutdown
Switch4(config-if-vlan3)#exit
```

Enable OSPF protocol to configure the OSPF area which interface vlan3 resides in. Switch4(config)#router ospf

```
Switch4(config-router)# network 30.1.1.0/24 area 0
Switch4(config-router)#exit
Switch4(config)#exit
Switch4#
```

Layer 3 Switch5:

Configuration of the IP address for interface vlan2

```
Switch5#config
Switch5(config)# interface vlan 2
Switch5(config-if-vlan2)# ip address 100.1.1.2 255.255.255.0
Switch5(config-if-vlan2)#no shutdown
Switch5(config-if-vlan2)#exit
```

Configuration of the IP address for interface vlan3

```
Switch5(config)# interface vlan 3
Switch5(config-if-vlan3)# ip address 30.1.1.1 255.255.255.0
Switch5(config-if-vlan3)#no shutdown
Switch5(config-if-vlan3)#exit
```

Enable OSPF protocol to configure the number of the area which interfaces vlan2 and vlan3 reside in.

```
Switch5(config)#router ospf
Switch5(config-router)# network 30.1.1.0/24 area 0
Switch5(config-router)# network 100.1.1.0/24 area 0
Switch5(config-router)#exit
Switch5(config)#exit
Switch5#
```

Scenario 2: Typical OSPF protocol complex topology.

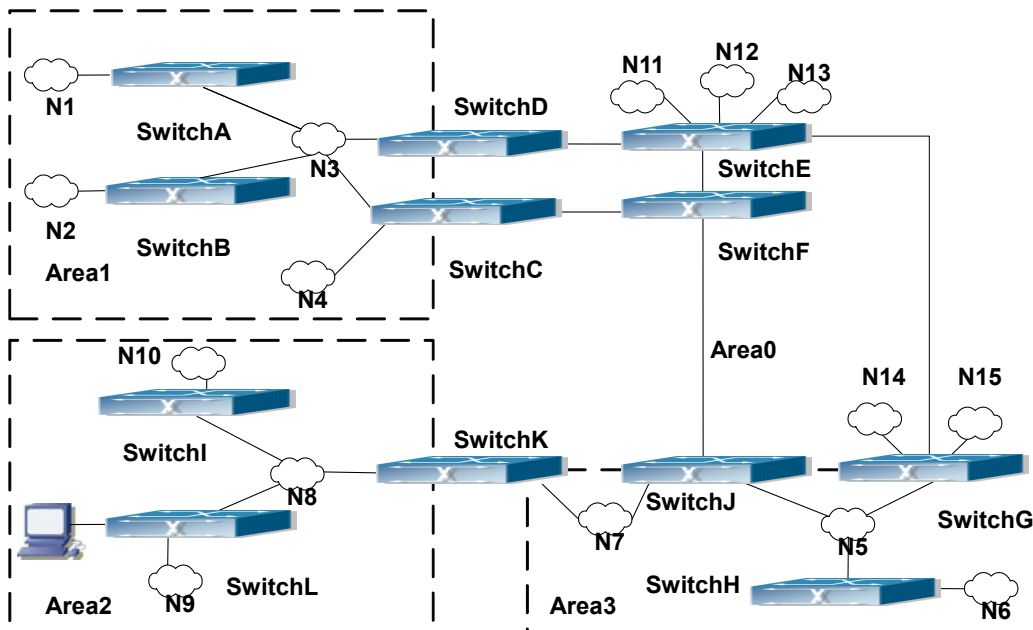

Figure 37-3-2 Typical complex OSPF autonomous system

This scenario is a typical complex OSPF autonomous system network topology. Area1 includes network N1-N4 and Layer3 SwitchA-SwitchD, area2 include network N8-N10, host H1 and Layer3 SwitchH, area3 include N5-N7 and Layer3 SwitchF, SwitchG SwitchA0 and Switch11, and network N8-N10 share a summary route with host H1(i.e. area3 is defined as a STUB area). Layer3 SwitchA, SwitchB, SwitchD, SwitchE, SwitchG, SwitchH, Switch12 are in-area Layer3 switches, SwitchC, SwitchD, SwitchF, Switch10 and Switch11 are edge Layer3 switches of the area, SwitchD and SwitchF are edge Layer3 switches of the autonomous system.

To area1, Layer3 switches SwitchA and SwitchB are both in-area switches, area edge switches SwitchC and SwitchD are responsible for reporting distance cost to all destination outside the area, while they are also responsible for reporting the position of the AS edge Layer3 switches SwitchD and SwitchF, AS exterior link-state advertisement from SwitchD and SwitchF are flooded throughout the whole autonomous system. When ASE LSA floods in area 1, those LSAs are included in the area 1 database to get the routes to network N11 and N15.

In addition, Layer3 SwitchC and SwitchD must summary the topology of area 1 to the backbone area (area 0, all non-0 areas must be connected via area 0, direct connections are not allowed), and advertise the networks in area 1 (N1-N4) and the costs from SwitchC and SwitchD to those networks. As the backbone area is required to keep connected, there must be a virtual link between backbone layer3 Switch10 and Switch11. The area edge layer3 switches exchange summary information via the backbone Layer3 switch, each area edge Layer3 switch listens to the summary information from the other edge Layer3 switches.

Virtual link can not only maintain the connectivity of the backbone area, but also strengthen the backbone area. For example, if the connection between backbone Layer3 SwitchG and Switch10 is cut down, the backbone area will become discontinuous. The backbone area can become more robust by establishing a virtual link between backbone Layer3 switches SwitchF and Switch10. In addition, the virtual link between SwitchF and Switch10 provide a short path from area 3 to Layer3 SwitchF.

Take area 1 as an example. Assume the IP address of Layer3 SwitchA is 10.1.1.1, IP address of Layer3 SwitchB interface VLAN2 is 10.1.1.2, IP address of Layer3 SwitchC interface VLAN2 is 10.1.1.3, IP address of Layer3 SwitchD interface VLAN2 is 10.1.1.4. SwitchA is connecting to network N1 through Ethernet interface VLAN1 (IP address 20.1.1.1); SwitchB is connecting to network N2 through Ethernet interface VLAN1 (IP address 20.1.2.1); SwitchC is connecting to network N4 through Ethernet interface VLAN3 (IP address 20.1.3.1). All the three addresses belong to area 1. SwitchC is connecting to Layer3 SwitchE through Ethernet interface VLAN1 (IP address 10.1.5.1); SwitchD is connecting to Layer3 SwitchD through Ethernet interface VLAN1 (IP address 10.1.6.1); both two addresses belong to area 1. Simple authentication is implemented among Layer3 switches in area1, edge Layer3 switches of area 1 authenticate with the area 0 backbone Layer3 switches by MD5 authentication.

The followings are just configurations for all Layer3 switches in area 1, configurations for Layer3 switches of the other areas are omitted. The following are the configurations of SwitchA, SwitchB, SwitchC and SwitchD:

1)SwitchA:

Configure IP address for interface vlan2

```
SwitchA#config
SwitchA(config)# interface vlan 2
SwitchA(config-if-Vlan2)# ip address 10.1.1.1 255.255.255.0
SwitchA(config-if-Vlan2)#exit
```

Enable OSPF protocol, configure the area number for interface vlan2.

```
SwitchA(config)#router ospf
SwitchA(config-router)#network 10.1.1.0/24 area 1
SwitchA(config-router)#exit
```

Configure simple key authentication.

```
SwitchA(config)#interface vlan 2
SwitchA(config-if-Vlan2)#ip ospf authentication
SwitchA(config-if-Vlan2)#ip ospf authentication-key DCS
```

```
SwitchA(config-lf-Vlan2)exit
```

Configure IP address and area number for interface vlan1.

```
SwitchA(config)# interface vlan 1
SwitchA(config-lf-Vlan1)#ip address 20.1.1.1 255.255.255.0
SwitchA(config-lf-Vlan1)#exit
SwitchA(config)#router ospf
SwitchA(config-router)#network 20.1.1.0/24 area 1
SwitchA(config-router)#exit
```

2)SwitchB:

Configure IP address for interface vlan2

```
SwitchB#config
SwitchB(config)# interface vlan 2
SwitchB(config-lf-Vlan2)# ip address 10.1.1.2 255.255.255.0
SwitchB(config-lf-Vlan2)#exit
```

Enable OSPF protocol, configure the area number for interface vlan2.

```
SwitchB(config)#router ospf
SwitchB(config-router)#network 10.1.1.0/24 area 1
SwitchB(config-router)#exit
SwitchB(config)#interface vlan 2
```

Configure simple key authentication.

```
SwitchB(config)#interface vlan 2
SwitchB(config-lf-Vlan2)#ip ospf authentication
SwitchB(config-lf-Vlan2)#ip ospf authentication-key DCS
SwitchB(config-lf-Vlan2)#exit
```

Configure IP address and area number for interface vlan1.

```
SwitchB(config)# interface vlan 1
SwitchB(config-lf-Vlan1)#ip address 20.1.2.1 255.255.255.0
SwitchB(config-lf-Vlan1)#exit
SwitchB(config)#router ospf
SwitchB(config-router)#network 20.1.2.0/24 area 1
SwitchB(config-router)#exit
SwitchB(config)#exit
```

3)SwitchC:

Configure IP address for interface vlan2

```
SwitchC#config
SwitchC(config)# interface vlan 2
SwitchC(config-If-Vlan2)# ip address 10.1.1.3 255.255.255.0
SwitchC(config-If-Vlan2)#exit
```

Enable OSPF protocol, configure the area number for interface vlan2

```
SwitchC(config)#router ospf
SwitchC(config-router)#network 10.1.1.0/24 area 1
SwitchC(config-router)#exit
```

Configure simple key authentication

```
SwitchC(config)#interface vlan 2
SwitchC(config-If-Vlan2)#ip ospf authentication
SwitchC(config-If-Vlan2)#ip ospf authentication-key DCS
SwitchC(config-If-Vlan2)#exit
```

Configure IP address and area number for interface vlan3

```
SwitchC(config)# interface vlan 3
SwitchC(config-If-Vlan3)#ip address 20.1.3.1 255.255.255.0
SwitchC(config-If-Vlan3)#exit
SwitchC(config)#router ospf
SwitchC(config-router)#network 20.1.3.0/24 area 1
SwitchC(config-router)#exit
```

Configure IP address and area number for interface vlan 1

```
SwitchC(config)# interface vlan 1
SwitchC(config-If-Vlan1)#ip address 10.1.5.1 255.255.255.0
SwitchC(config-If-Vlan1)#exit
SwitchC(config)#router ospf
SwitchC(config-router)#network 10.1.5.0/24 area 0
SwitchC(config-router)#exit
```

Configure MD5 key authentication.

```
SwitchC(config)#interface vlan 1
SwitchC (config-If-Vlan1)#ip ospf authentication message-digest
SwitchC (config-If-Vlan1)#ip ospf authentication-key DCS
SwitchC (config-If-Vlan1)#exit
SwitchC(config)#exit
SwitchC#
```

4)SwitchD:

Configure IP address for interface vlan2

```
SwitchD#config
SwitchD(config)# interface vlan 2
SwitchD(config-If-Vlan2)# ip address 10.1.1.4 255.255.255.0
SwitchD(config-If-Vlan2)#exit
```

Enable OSPF protocol, configure the area number for interface vlan2.

```
SwitchD(config)#router ospf
SwitchD(config-router)#network 10.1.1.0/24 area 1
SwitchD(config-router)#exit
```

Configure simple key authentication.

```
SwitchD(config)#interface vlan 2
SwitchD(config-If-Vlan2)#ip ospf authentication
SwitchD(config-If-Vlan2)#ip ospf authentication-key DCS
SwitchD(config-If-Vlan2)#exit
```

Configure the IP address and the area number for the interface vlan 1

```
SwitchD(config)# interface vlan 1
SwitchD(config-If-Vlan1)# ip address 10.1.6.1 255.255.255.0
SwitchD(config-If-Vlan1)#exit
SwitchD(config)#router ospf
SwitchD(config-router)#network 10.1.6.0/24 area 0
SwitchD(config-router)#exit
```

Configure MD5 key authentication

```
SwitchD(config)#interface vlan 1
SwitchD(config-If-Vlan1)#ip ospf authentication message-digest
SwitchD(config-If-Vlan1)#ip ospf authentication-key DCS
SwitchD(config-If-Vlan1)#exit
SwitchD(config)#exit
SwitchD#
```

Scenario 3: The function of OSPF importing the routers of other OSPF processes

As shown in the following graph, a switch running the OSPF routing protocol connects two networks: network A and network B. Because of some reason, it is required that network A should be able to learn the routers of network B, but network B should not be able to learn the routers of network A. According to that, two OSPF processes can be started respectively on interface vlan 1 and interface vlan 2. the OSPF process which interface vlan 1 belongs to is configured to import the routers of the OSPF process which interface vlan 2 belongs to, while the OSPF process which interface vlan 2 belongs to should not be configured to import the routers of the OSPF process which interface vlan 1 belongs to.

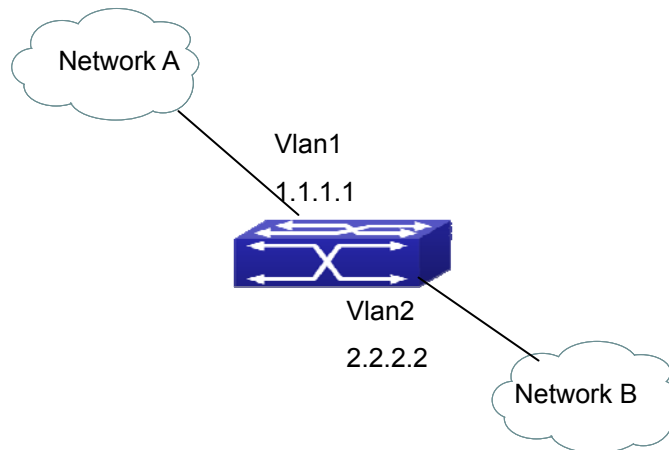

Figure 37-3-3 Function of OSPF importing the routers of other OSPF processes example

We can configure as follows:

```
XGS3-42000R(config)#interface vlan 1
XGS3-42000R(config-if-Vlan1)#ip address 1.1.1.1 255.255.255.0
XGS3-42000R(config-if-Vlan1)#exit
XGS3-42000R(config)#interface vlan 2
XGS3-42000R(config-if-Vlan2)#ip address 2.2.2.2 255.255.255.0
XGS3-42000R(config-if-Vlan2)#exit
XGS3-42000R(config)#router ospf 10
XGS3-42000R(config-router)#network 2.2.2.0/24 area 1
XGS3-42000R(config-router)#exit
XGS3-42000R(config)#router ospf 20
XGS3-42000R(config-router)#network 1.1.1.0/24 area 1
XGS3-42000R(config-router)#redistribute ospf 10
XGS3-42000R(config-router)#exit
```

37.3.2 Configuration Examples of OSPF VPN

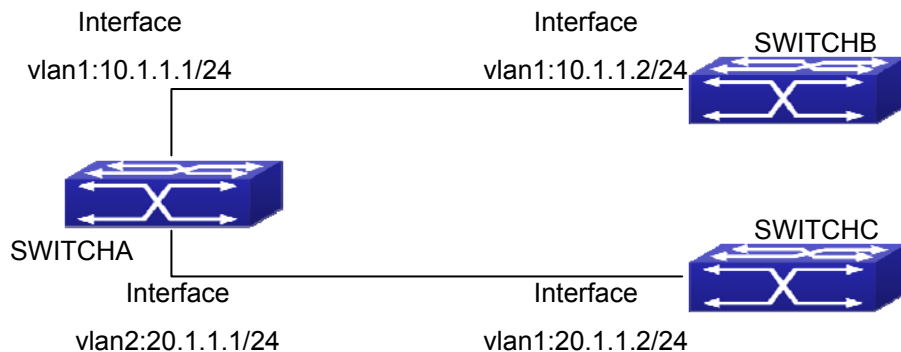

Figure 37-3-4 OSPF VPN Example

The above figure shows that a network consists of three Layer 3 switches in which the switchA as PE, SwitchB and SwitchC as CE1 and CE2. The PE is connected to CE1 and CE2 through vlan1 and vlan2. The routing messages are exchanged between PE and CE through OSPF protocol.

a) SwitchA, the Layer 3 switch as PE

Configure VPN route/transmitting examples vpnb and vpnc

```
SwitchA#config
SwitchA(config)#ip vrf vpnb
SwitchA(config-vrf)#
SwitchA(config-vrf)#exit
SwitchA#(config)
SwitchA(config)#ip vrf vpnc
SwitchA(config-vrf)#
SwitchA(config-vrf)#exit
```

Associate the vlan 1 and vlan 2 respectively with vpnb and vpnc while configuring IP address

```
SwitchA(config)#in vlan1
SwitchA(config-if-Vlan1)#ip vrf forwarding vpnb
SwitchA(config-if-Vlan1)#ip address 10.1.1.1 255.255.255.0
SwitchA(config-if-Vlan1)#exit
SwitchA(config)#in vlan2
SwitchA(config-if-Vlan2)#ip vrf forwarding vpnc
SwitchA(config-if-Vlan2)#ip address 20.1.1.1 255.255.255.0
SwitchA(config-if-Vlan2)#exit
```

Configure OSPF examples associated with vpnb and vpnc respectively

```
SwitchA(config)#
SwitchA(config)#router ospf 100 vpnb
SwitchA(config-router)#network 10.1.1.0/24 area 0
SwitchA(config-router)#redistribute bgp
SwitchA(config-router)#exit
SwitchA(config)#router ospf 200 vpnc
SwitchA(config-router)#network 20.1.1.0/24 area 0
SwitchA(config-router)#redistribute bgp
```

b) The Layer 3 SwitchB of CE1 :

Configure the IP address of Ethernet E 1/2

```
SwitchB#config
SwitchB(config)# interface Vlan1
SwitchB(config-if-vlan1)# ip address 10.1.1.2 255.255.255.0
SwitchB (config-if-vlan1)exit
```

Enable OSPF protocol and configuring OSPF segments

```
SwitchB(config)#router ospf
SwitchB(config-router-rip)#network 10.1.1.0/24 area 0
SwitchB(config-router-rip)#exit
```

c) The Layer 3 SwitchC of CE2

Configure the IP address of Ethernet E 1/2

```
SwitchC#config
SwitchC(config)# interface Vlan1
SwitchC(config-if-vlan1)# ip address 20.1.1.2 255.255.255.0
SwitchC(config-if-vlan1)#exit
```

Initiate OSPF protocol and configuring OSPF segments

```
SwitchC(config)#router ospf
SwitchC(config-router)#network 20.1.1.0/24 area 0
SwitchC(config-router)#exit
```

37.4 OSPF Troubleshooting

The OSPF protocol may not be working properly due to errors such as physic connection, configuration error when configuring and using the OSPF protocol. So users should pay attention to following:

- First ensure the physic connection is correct
- Second, ensure the interface and link protocol are UP (use **show interface** command)
- Configure different IP address from different segment on each interface
- Then initiate OSPF protocol (use **router-ospf** command) and configure the OSPF area on corresponding interface
- After that, a OSPF protocol feature should be checked---the OSPF backbone area should be continuous and apply virtual link to ensure it is continuous. if not; all non 0 areas should only be connected to other non 0 area through 0 area; a border Layer 3 switch means that one part of the interfaces of this switch belongs to 0 area, the other part belongs to non 0 area; Layer 3 switch DR should be specified for multi-access network such as broadcast network.

Chapter 38 OSPFv3

38.1 Introduction to OSPFv3

OSPFv3(Open Shortest Path First) is the third version for Open Shortest Path First, and it is the IPv6 version of OSPF Protocol. It is an interior dynamic routing protocol for autonomous system based on link-state. The protocol creates a link-state database by exchanging link-states among Layer3 switches, and then uses the Shortest Path First algorithm to generate a route table basing on that database.

Autonomous system (AS) is a self-managed interconnected network. In large networks, such as the Internet, a giant interconnected network is broken down to autonomous systems. Big enterprise networks connecting to the Internet are independent AS, since the other hosts on the Internet are not managed by those AS and they don't share interior routing information with the Layer3 switches on the Internet.

Each link-state Layer3 switch can provide information about the topology with its neighboring Layer3 switches.

- The network segment (link) connecting to the Layer3 switch
- State of the connecting link

Link-state information is flooded throughout the network so that all Layer3 switches can get first hand information. Link-state Layer3 switches will not broadcast all information contained in their route tables; instead, they only send changed link-state information. Link-state Layer3 switches establish neighborhood by sending "HELLO" to their neighbors, then link-state advertisements (LSA) will be sent among neighboring Layer3 switches. Neighboring Layer3 switch copy the LSA to their routing table and transfer the information to the rest part of the network. This process is referred to as "flooding". In this way, firsthand information is sent throughout the network to provide accurate map for creating and updating routes in the network. Link-state routing protocols use cost instead of hops to decide the route. Cost is assigned automatically or manually. According to the algorithm in link-state protocol, cost can be used to calculate the hop number for packets to pass, link bandwidth, and current load of the link, the administrator can even add weight for better assessment of the link-state.

- 1) When a link-state Layer3 switch enters a link-state interconnected network, it sends a HELLO packet to get to know its neighbors and establish neighborhood.
- 2) The neighbors respond with information about the links they are connecting and the related costs.
- 3) The originate Layer3 switch uses this information to build its own routing table.
- 4) Then, as part of the regular update, Layer3 switch send link-state advertisement (LSA) packets to its neighboring Layer3 switches. The LSA include links and related costs of that Layer3 switch.
- 5) Each neighboring Layer3 switch copies the LSA packet and passes it to the next neighbor (i.e. flooding).
- 6) Since routing database is not recalculated before Layer3 switch forwards LSA flooding, the converging time is greatly reduced.

One major advantage of link-state routing protocols is the fact that infinite counting is impossible, this is because of the way link-state routing protocols build up their routing table. The second advantage is that converging in a link-state interconnected network is very fast, once the routing topology changes, updates will be flooded throughout the network very soon. Those advantages release some Layer3 switch resources, as the process ability and bandwidth used by bad route information are minor.

The features of OSPFv3 protocol include the following: OSPFv3 supports networks of various scales, several hundreds of Layer3 switches can be supported in an OSPFv3 network. Routing topology changes can be quickly found and updating LSAs can be sent immediately, so that routes converge quickly. Link-state information is used in shortest path algorithm for route calculation, eliminating loop route. OSPFv3 divides the autonomous system into areas, reducing database size, bandwidth occupation and calculation load. (According to the position of Layer3 switches in the autonomous system, they can be grouped as internal area switches, area edge switches, AS edge switches and backbone switches). OSPFv3 supports load balance and multiple routes to the same destination of equal costs. OSPFv3 supports 4 level routing mechanisms (process routing according to the order of route inside an area, route between areas, type 1 external route and type 2 external route). OSPFv3 support IP subnet and redistribution of routes from the other routing protocols, and interface-based packet verification. OSPFv3 supports sending packets in multicast.

Each OSPFv3 Layer3 switch maintains a database describing the topology of the whole autonomous system. Each Layer3 switch gathers the local status information, such as available interface, reachable neighbors, and sends link-state advertisement (sending out link-state information) to exchange link-state information with other OSPFv3 Layer3 switches to form a link-state database describing the whole autonomous system. Each Layer3 switch builds a shortest path tree rooted by itself according to the link-state database, this tree provide the routes to all nodes in an autonomous system. If two or more Layer3 switches exist (i.e. multi-access network), "designated Layer3 switch" and "backup designated Layer3 switch" will be selected. Designated Layer3 switch is responsible for spreading link-state of the network. This concept helps reducing the traffic among the Layer3 switches in multi-access network.

OSPFv3 protocol requires the autonomous system to be divided into areas. That is to divide the autonomous system into 0 area (backbone area) and non-0 areas. Routing information between areas are further abstracted and summarized to reduce the bandwidth required in the network. OSPFv3 uses four different kinds of routes: they are the route inside the area, route between areas, type 1 external route and type 2 external route, in the order of highest priority to lowest. The route inside an area and between areas describe the internal network structure of an autonomous system, while external routes describe external routes describe how to select the routing information to destination outside the autonomous system. The first type of exterior route corresponds to the information introduced by OSPFv3 from the other interior routing protocols, the costs of those routes are comparable with the costs of OSPFv3 routes; the second type of exterior route corresponds to the information introduced by OSPFv3 from the other exterior routing protocols, but the costs of those routes are far greater than that of OSPFv3 routes, so OSPFv3 route cost is ignored when calculating route costs.

OSPFv3 areas are centered with the Backbone area, identified as the Area 0, all the other areas must be connected to Area 0 logically, and Area 0 must be continuous. For this reason, the concept of virtual link is introduced to the backbone area, so that physically separated areas still have logical connectivity to the backbone area. The configurations of all the Layer3 switches in the same area must be the same.

In one word, LSA can only be transferred between neighboring Layer3 switches, and OSPFv3 protocol includes seven kinds of LSA: link LSA, internal-area prefix LSA, router LSA, network LSA, inter-area prefix LSA, inter-area router LSA and autonomous system exterior LSA. Router LSA is generated by each Layer 3 switch in an OSPF area, and is sent to all other neighboring Layer 3 switch in this area; network LSA is generated by designated Layer 3 switch in the OSPF area of multi-access network and is sent to all other neighboring Layer3 switches in this area.(To reduce data traffic among each Layer 3 switches in the multi-access network, “designated Layer3 switch” and “backup designated layer3 switch” should be selected in the multi-access network, and the network link-state is broadcasted by designated Layer 3 switch); the inter-area prefix LSA and inter-area router LSA are generated by OSPF area border Layer 3 switches and transferred among those switches. The autonomous system exterior LSA is generated by autonomous system exterior border Layer 3 switches and transferred in the whole autonomous system. Link LSA is generated by Layer 3 switch on the link and sent to other Layer 3 switches on the link. Internal-area prefix LSA is generated by designated Layer3 switch of each link in this area, and flooded to the whole area.

For autonomous system focused on exterior link-state announcement, OSPFv3 allow some areas to be configured as STUB areas in order to reduce the size of topological database. Router LSA, network LSA, inter-area prefix LSA, link LSA, internal-area prefix LSA are permitted to advertise to STUB area. Default route must be used in STUB area, Layer 3 switches on the area border of STUB area announces to default routes of STUB area by inter-area prefix LSA; these default routes only flood in STUB area, not outside of STUB area. Each STUB area has a corresponding default route, the route from STUB area to AS exterior destination depends only on default route of this area.

The following simply outlines the route calculation process of OSPFv3 protocol:

1. Each OSPF-enabled Layer3 switch maintains a database (LS database) describing the link-state of the topology structure of the whole autonomous system. Each Layer3 switch generates a link-state advertisement according to its surrounding network topology structure (router LSA), and sends the LSA to other Layer3 switches through link-state update (LSU) packets. Thus, each layer3 switches receives LSAs from other layer3 switches, and all LSAs combined to the link-state database.
2. Since a LSA is the description of the network topology structure around a layer3 switch, the LS database is the description of the network topology structure of the whole network. The layer3 switches can easily create a weighted vector map according to the LS database. Obviously, all layer3 switches in the same autonomous system will have the same network topology map.
3. Each Layer3 switch uses the shortest path first (SPF) algorithm to calculate a tree of shortest path rooted by itself. The tree provides the route to all the nodes in the autonomous system, leaf nodes consist of the exterior route information. The exterior route can be marked by the Layer3 switch broadcast it, so that additional information about the autonomous system can be recorded. As a result, the route table of each Layer3 switch is different.

OSPFv3 protocol is developed by the IETF, the OSPF v3 used now is fulfilled according to the content described in RFC2328 and RFC2740.

As a result of continuous development of IPv6 network, it has the network environment of nonsupport IPv6 sometimes, so it needs to do the IPv6 operation by tunnel. Therefore, our OSPFv3 supports configuration on configure tunnel, and passes through nonsupport IPv6 network by unicast packet of IPv4 encapsulation.

38.2 OSPFv3 Configuration Task List

OSPFv3 Configuration Task List:

1. Enable OSPFv3 (required)
 - (1) Enable/disable OSPFv3(required)
 - (2) Configure the router-id number of the Layer3 switch running OSPFv3 (optional)
 - (3) Configure the network scope for running OSPFv3 (optional)
 - (4) Enable OSPFv3 on the interface (required)
2. Configure OSPFv3 auxiliary parameters (optional)
 - (1) Configure OSPFv3 packet sending mechanism parameters
 - 1) Set the OSPFv3 interface to receive only
 - 2) Configure the cost for sending packets from the interface
 - 3) Configure OSPFv3 packet sending timer parameter (timer of broadcast interface sending HELLO packet to poll, timer of neighboring Layer3 switch invalid timeout, timer of LSA transmission delay and timer of LSA retransmission.
 - (2) Configure OSPFv3 route introduction parameters
 - 1) Configure default parameters (default type, default tag value, default cost)
 - 2) Configure the routes of the other protocols to introduce to OSPFv3
 - (3) Configure OSPFv3 importing the routes of other OSPFv3 processes
 - 1) Enable the function of OSPFv3 importing the routes of other OSPFv3 processes
 - 2) Display relative information
 - 3) Debug
 - (4) Configure other OSPFv3 protocol parameters
 - 1) Configure OSPFv3 routing protocol priority
 - 2) Configure cost for OSPFv3 STUB area and default route
 - 3) Configure OSPFv3 virtual link
 - 4) Configure the priority of the interface when electing designated Layer3 switch
3. Close OSPFv3 Protocol

1. Enable OSPFv3 Protocol

It is very simple to run the basic configurations of OSPFv3 routing protocol on the Layer 3 switch of XGS3 series switch, normally only enabling OSPFv3, implement OSPFv3 interface, the default value is defined to OSPFv3 protocol parameters. Refer to 2. Configure OSPF auxiliary parameters, if the OSPFv3 protocol parameters need to be modified.

Commands	Explanation
Global Mode	
[no] router IPv6 ospf <tag>	The command initializes OSPFv3 routing process and enter OSPFv3 mode to configure OSPFv3 routing process. The [no] router IPv6 ospf <tag> command stops relative process. (required)
OSPFv3 Protocol Configure Mode	

router-id <router_id> no router-id	Configure router for OSPFv3 process. The no router-id command returns ID to 0.0.0.0 .(required)
[no] passive-interface<ifname>	Configure an interface receiving without sending. The [no] passive-interface<ifname> command cancels configuration.
Interface Configuration Mode	
[no] IPv6 router ospf {area <area-id> [instance-id <instance-id> tag <tag> [instance-id <instance-id>]] tag <tag> area <area-id> [instance-id <instance-id>]}	Implement OSPFv3 routing on the interface. The [no] IPv6 router ospf {area <area-id> [instance-id <instance-id> tag <tag> [instance-id <instance-id>]] tag <tag> area <area-id> [instance-id <instance-id>]} command cancels configuration.

2. Configure OSPFv3 parameters

(1) Configure OSPFv3 packet sending mechanism parameters

- 1) Set the OSPF interface to receive only
- 2) Configure the cost for sending packets from the interface

Commands	Explanation
Interface Configuration Mode	
IPv6 ospf cost <cost> [instance-id <id>] no IPv6 ospf cost [instance-id <id>]	Appoint interface to implement required cost of OSPFv3 protocol. The no IPv6 OSPF cost [instance-id <id>] restores the default setting.

- 3) Configure OSPFv3 packet sending timer parameter (timer of broadcast interface sending HELLO packet to poll, timer of neighboring Layer3 switch invalid timeout, timer of LSA transmission delay and timer of LSA retransmission.

Commands	Explanation
Interface Configuration Mode	
IPv6 ospf hello-interval <time> [instance-id <id>] no IPv6 ospf hello-interval [instance-id <id>]	Sets interval for sending HELLO packets; the “ no IPv6 ospf hello-interval [instance-id <id>] ” command restores the default setting.
IPv6 ospf dead-interval <time> [instance-id <id>] no IPv6 ospf dead-interval [instance-id <id>]	Sets the interval before regarding a neighbor Layer3 switch invalid; the “ no IPv6 ospf dead-interval [instance-id <id>] ” command restores the default setting.
IPv6 ospf transit-delay <time> [instance-id <id>] no IPv6 ospf transit-delay [instance-id <id>]	Sets the delay time before sending link-state broadcast; the “ no IPv6 ospf transit-delay [instance-id <id>] ” command restores the default setting.

IPv6 ospf retransmit <time> [instance-id <id>] no IPv6 ospf retransmit [instance-id <id>]	.Sets the interval for retransmission of link-state advertisement among neighbor Layer3 switches; the “no IPv6 ospf retransmit [instance-id <id>]” command restores the default setting.
---	--

(2) Configure OSPFv3 route introduction parameters

Configure OSPFv3 route introduction parameters

Commands	Explanation
OSPF Protocol Mode	
[no]redistribute {kernel connected static rip isis bgp} [metric<value>] [metric-type {1 2}][route-map<word>]	Introduces other protocol discovery routing and static routing regarded as external routing message. The [no] redistribute {kernel connected static rip isis bgp} [metric<value>] [metric-type {1 2}][route-map<word>] command cancels imported external routing message.

(3) Configure OSPFv3 importing the routes of other OSPFv3 processes

1) Enable the function of OSPFv3 importing the routes of other OSPFv3 processes

Command	Explanation
Router IPv6 OSPF Mode	
redistribute ospf [<process-id>] [metric<value>] [metric-type {1 2}][route-map<word>] no redistribute ospf [<process-id>] [metric<value>] [metric-type {1 2}][route-map<word>]	Enable or disable the function of OSPFv3 importing the routes of other OSPFv3 processes.

2) Display related information

Command	Explanation
Admin Mode or Configure Mode	
show ipv6 ospf [<process-id>] redistribute	Display the configuration information of the OSPFv3 process importing other outside routes.

3) Debug

Command	Explanation
Admin Mode	
debug ipv6 ospf redistribute message send no debug ipv6 ospf redistribute message send debug ipv6 ospf redistribute route receive no debug ipv6 ospf redistribute route receive	Enable or disable debugging of sending command from OSPFv3 process redistributed to other OSPFv3 process routing. Enable or disable debugging of received routing message from NSM for OSPFv3 process.

(4) Configure Other Parameters of OSPFv3 Protocol

- 1) Configure OSPFv3 STUB Area & Default Routing Cost
- 2) Configure OSPFv3 Virtual Link

Commands	Explanation
OSPFv3 Protocol Configuration Mode	
timers spf <spf-delay> <spf-holdtime> no timers spf	Configure OSPFv3 SPF timer. The no timers spf command recovers default value.
area <id> stub [no-summary] no area <id> stub [no-summary] area <id> default-cost <cost> no area <id> default-cost area <id> virtual-link A.B.C.D [instance-id <instance-id> INTERVAL] no area <id> virtual-link A.B.C.D [INTERVAL]	Configure parameters in OSPFv3 area (STUB area, Virtual link). The no command restores default value.

- 4) Configure the priority of the interface when electing designated Layer3 XGS3-42000R(DR).

Commands	Explanation
Interface Configuration Mode	
IPv6 ospf priority <priority> [instance-id <id>] no IPv6 ospf priority [instance-id <id>]	Sets the priority of the interface in “designated Layer3 switch” election; the “ no IPv6 ospf priority [instance-id <id>] ” command restores the default setting.

3. Disable OSPFv3 Protocol

Commands	Explanation
Global Mode	
no router IPv6 ospf ospf [<tag>]	Disable OSPFv3 Routing Protocol.

38.3 OSPFv3 Examples

Examples 1: OSPF autonomous system.

This scenario takes an OSPF autonomous system consisting of five switches for example, where Layer3 SwitchA and SwitchD make up OSPF area 0, Layer3 Switch2 and Switch3 form OSPF area 1 (assume vlan1 interface of Layer3 SwitchA belongs to area 0), Layer3 SwitchD forms OSPF area2 (assume vlan2 interface of Layer3 SwitchD belongs to area 0). Switch1 and SwitchD are backbone Layer3 switches, Switch2 and SwitchD are area edge Layer3 switches, and Switch3 is the in-area Layer3 switch.

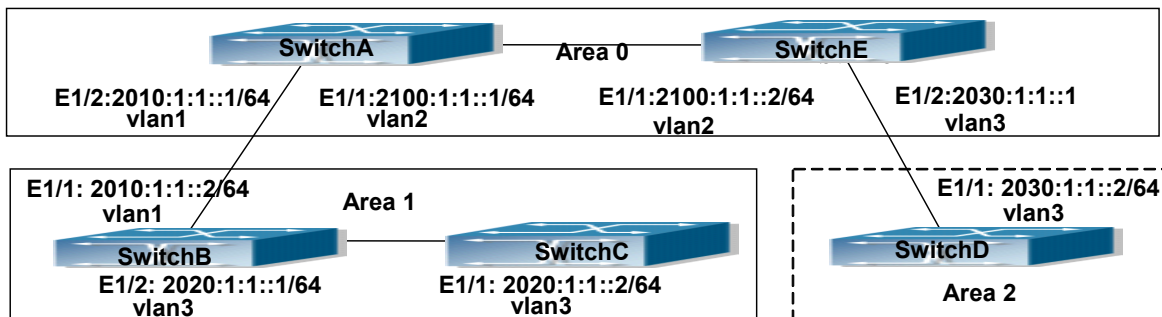

Figure 38-3-1 Network topology of OSPF autonomous system

The configuration for Layer3 SwitchA and SwitchE is shown below:

Layer3 SwitchA:

Enable OSPFv3 protocol to configure router ID

```
SwitchA(config)#router IPv6 ospf
SwitchA (config-router)#router-id 192.168.2.1
```

Configure interface vlan1 IPv6 address and affiliated OSPFv3 area

```
SwitchA#config
SwitchA(config)# interface vlan 1
SwitchA(config-if-vlan1)# IPv6 address 2010:1:1::1/64
SwitchA(config-if-vlan1)# IPv6 router ospf area 0
SwitchA(config-if-vlan1)#exit
```

Configure interface vlan2 IP address and affiliated OSPFv3 area

```
SwitchA(config)# interface vlan 2
SwitchA(config-if-vlan2)# IPv6 address 2100:1:1::1/64
SwitchA(config-if-vlan2)# IPv6 router ospf area 0
SwitchA (config-if-vlan2)#exit
SwitchA(config)#exit
SwitchA#
```

Layer 3 SwitchB:

Enable OSPFv3 protocol to configure router ID

```
SwitchB(config)#router IPv6 ospf
SwitchB (config-router)#router-id 192.168.2.2
```

Configure interface vlan1 address, VLAN2 IPv6 address and affiliated OSPFv3 area

```
SwitchB#config
SwitchB(config)# interface vlan 1
SwitchB(config-if-vlan1)# IPv6 address 2010:1:1::2/64
```

```
SwitchB(config-if-vlan1)# IPv6 router ospf area 0
SwitchB(config-if-vlan1)#exit
SwitchB(config)# interface vlan 3
SwitchB(config-if-vlan3)# IPv6 address 2020:1:1::1/64
SwitchB(config-if-vlan3)# IPv6 router ospf area 1
SwitchB(config-if-vlan3)#exit
SwitchB(config)#exit
SwitchB#
```

Layer 3 SwitchC:

Enable OSPFv3 protocol to configure router ID

```
SwitchC(config)#router IPv6 ospf
SwitchC(config-router)#router-id 192.168.2.3
```

Configure interface vlan3 IPv6 address and affiliated OSPFv3 area

```
SwitchC#config
SwitchC(config)# interface vlan 3
SwitchC(config-if-vlan3)# IPv6 address 2020:1:1::2/64
SwitchC(config-if-vlan3)# IPv6 router ospf area 1
SwitchC(config-if-vlan3)#exit
SwitchC(config)#exit
SwitchC#
```

Layer 3 SwitchD:

Enable OSPFv3 protocol to configure router ID

```
SwitchD(config)#router IPv6 ospf
SwitchD(config-router)#router-id 192.168.2.4
```

Configure interface vlan3 IPv6 address and affiliated OSPFv3 area

```
SwitchD#config
SwitchD(config)# interface vlan 3
SwitchD(config-if-vlan3)# IPv6 address 2030:1:1::2/64
SwitchD(config-if-vlan3)# IPv6 router ospf area 0
SwitchD(config-if-vlan3)#exit
SwitchD(config)#exit
SwitchD#
```

Layer 3 SwitchE:

Startup OSPFv3 protocol, configure router ID

```
SwitchE(config)#router IPv6 ospf
SwitchE(config-router)#router-id 192.168.2.5
```

Configure interface IPv6 address and affiliated OSPFv3 area

```
SwitchE#config
SwitchE(config)# interface vlan 2
SwitchE(config-if-vlan2)# IPv6 address 2100:1:1::2/64
SwitchE(config-if-vlan2)# IPv6 router ospf area 0
SwitchE(config-if-vlan2)#exit
```

Configure interface VLAN3 IPv6 address and affiliated area

```
SwitchE(config)# interface vlan 3
SwitchE(config-if-vlan3)# IPv6 address 2030:1:1::1/64
SwitchE(config-if-vlan3)# IPv6 router ospf area 0
SwitchE(config-if-vlan3)#exit
SwitchE(config)#exit
SwitchE#
```

38.4 OSPFv3 Troubleshooting

In the process of configuring and implementing OSPFv3, physical connection, configuration false probably leads to OSPFv3 protocol doesn't work. Therefore, the customers should give their attention to it:

- First of all, to ensure correct physical connection;
- Secondly, to ensure interface and link protocol are UP (execute **show interface** instruction);
- And configure IPv6 address of the different net segment on every interface.
- To startup OSPFv3 protocol (execute **router IPv6 OSPF** instruction), and configure affiliated OSPFv3 area on relative interface.
- And then, consider OSPFv3 protocol characteristic -- OSPFv3 backbone area (area 0) must be continuous. If it doesn't ensure that virtual link is implemented continuously, all of not area 0 only can be connected by area 0 and other not area 0, not directly connected by not area 0; The border Layer 3 switch is a part of this Layer 3 switch interface belongs to area 0, and another part of interface belongs to not area 0; for multi-access net etc like broadcast, Layer 3 switch DR needs vote and appoint; for each OSPFv3 process must not configure router ID of 0.0.0.0 address.

Chapter 39 BGP

39.1 Introduction to BGP

BGP stands for a Border Gateway Protocol. It's a dynamic routing protocol inter-autonomous system. Its basic function is automatically exchanging routing information without loops. By exchanging routing reachable information with autonomous number of AS sequence attributes, BGP could create autonomous topological map to eliminate routing loop and implement policies configured by users. Generally, the switches in an AS may use several IGPs (Interior Gateway Protocol) in order to exchange routing information in the AS, such as RIP and OSPF which are IGPs; and exchange information among ASes with EGP (Exterior Gateway Protocol). For example, BGP is one kind of EGP. The AS is usually established on a single administrative department. BGP is often used on the switches among ISPs or the departments of Multi-national Corporation. BGP has been used since 1989. Its earliest three versions are RFC1105 (BGP-1), RFC1163 (BGP-2) and RFC1267 (BGP-3). Currently, the most popular one is RFC1771 (BGP-4). The switch supports BGP-4.

1 · Characteristics of BGP-4

BGP-4 is suitable for the distributed structure and supports Classless InterDomain Routing (CIDR). BGP-4 is becoming the virtual exterior routing protocol standard used for the global Internet. The features of BGP-4 are as follows.

- BGP is an exterior routing protocol, unlike interior routing protocol, such as OSPF and RIP, BGP can't discovery and calculate routes, but it can control the transmission of routes and select the best route.
- By carrying AS routing information in the updating route, the problem of Routing Loops can be resolved
- BGP uses TCP on port 179 as its transport protocol, this could enhance the reliability of the protocol.
- BGP-4 supports CIDR (Classless InterDomain Routing), which is an important improvement to BGP-3. CIDR has a brand new way to look on IP address; it doesn't distinguish class A, Class B and class C network. For instance, an illegal class C address 192.213.0.0 255.255.0.0 can be represented as 192.213.0.0/16 by CIDR which is a legal super network. /16 represents that the network number is formed by 16 bits from the beginning left of the address. The introduction of CIDR abbreviates the route aggregation. The route aggregation is the process of combining several different routes. So notifying several routes can be changed to notify only one route which decreases the route table.
- When updating route, BGP send only incremental route. The bandwidth occupied by BGP transmission is reduced greatly and it is suitable for the mass routing information transmitted on the internet
- For political and economical reasons, each AS expects to filter and control the route, BGP-4 provides abundant route policies which make BGP-4 more extendable to encourage the internet development.

2 · The Overview of BGP-4 operation

Unlike RIP and OSPF protocols, BGP protocol is connection oriented. BGP switches must establish connection to exchange routing information. The operation of BGP protocol is driven by messages and the messages can be divided into four kinds:

Open message --It's the first message which is sent after a TCP connection is established. It is used to create BGP connecting relation among BGP peers. Some parameters in Open Message are used to negotiate if a connection could be established among BGP peers.

Keepalive Message -- It's the message to check connection availability. It's usually sent periodically to keep BGP connection. If this message or Update message is not received within holdtime time, BGP connection is closed.

Update Message -- It's the most important message in the BGP system. It's used to exchange routing information among peers. The switches exchange not only updated routing information, but also unavailable or canceled routing information. It consists of three parts: unreachable route, NLRI (Network Layer Reachability Information) and Path Attributes.

Notification Message -- It's the mistake notification message. When a BGP speaker receives this message, it shuts down the BGP connections with its neighbors.

BGP-4 is connection oriented. BGP acts as a higher protocol and runs on a particular equipment. When detecting a neighbor, a TCP session is established and maintained. Then the exchange and synchronization of the route table will be carried out. By sending the whole BGP route table the routing information is exchanged only when the system initiates. After that, the routing information is exchanged only when the updated routing information is available. Only incrementally updated message is exchanged. BGP-4 maintains links and sessions periodically through keep alive message. That is sending and receiving keep alive message periodically to check if the connections are normal.

The switches that participate the BGP session are called BGP speaker. It continuously receives or generates new routing information and advertises it to other BGP speakers. When a BGP speaker receives a new routing notification from other AS, if this route is better than the presently known route or there is no acceptable route, it sends this route to all the other BGP speakers of the AS. A BGP speaker calls other speakers that exchange route information with it as neighbors or peers. Several relevant neighbors can constitute a peer group. BGP operates on the switches in the following two manners:

- IBGP: Internal BGP
- EBGP: External BGP

When BGP runs in the same AS, it's called IBGP. When in the different AS, it's called EBGP. Generally, the outer neighbors are connected physically and the inner neighbors can be in any place of the AS. The difference is finally shown in the dealing manner of BGP to routing information. The equipment may check the AS numbers of the Open Message from neighbors to decide treating the neighbor switches as the exterior neighbor or as the interior neighbor.

IBGP are used in the AS. It sends message to all the BGP neighbors in the AS. IBGP exchanges AS routing information in a big organization. Attention, the switches in the AS needn't be connected physically. Only if the switches are in the same AS, they can be neighbors each other. Because BGP can't detect route, the route tables of other inner route protocols (such as static route, direct route, OSPF and RIP) need contain neighbor IP addresses and these routes are used to exchange information among BGPs. In order to avoid routing loops, when a BGP speaker receives a route notification from inner neighbor, it would not notify this route to other inner neighbors.

EBGP is used among the AS, and it transmits routing information to the BGP neighbors of outer ASes. EBGP need physical connection and share the same medium. Because EBGP need physical connection, the boundary equipments between two AS are usually running EBGP. When a BGP speaker receives routing information from outer neighbors, it notifies these routes to other inner neighbors.

3 · Route attribute

BGP-4 can share and query inner IP route table through relevant mechanisms, but it has its own route table. In the BGP route table, each route has a network number, AS listing information (also called AS path) that it passed and some routing attributes (such as origin). The routing attribute that BGP-4 used is very complex, this attribute can be used as metrics to select path.

4 · Route-selecting policy of BGP

When receiving BGP notification about a same route from several neighbors, selecting the best route need to be take into account after routing filtering. This process is called BGP route selecting process. BGP route selecting process will start only when the following conditions are fulfilled:

- The switch's route must be next hop reachable. That is in the route table there is the route that can reach the next hop.
- BGP must be synchronized with IGP (unless asynchronism is configured; only restricted to IBGP)

BGP route selecting process is based on the BGP attribute. When there are several routes that indicate the same destination, BGP need select the best route to the destination. The decision-making process is as follows:

1. Select the route with the most weight first;
2. If the weights are the same, select the route with the most local preference;
3. If the local preferences are the same, select the route generated by local switch.
4. If the local preferences are the same and there is no route generated by local switch, select the route with the shortest AS path;
5. If the AS paths are the same, select the route with the lowest "origin" type (IGP<EGP<INCOMPLETE);
6. If the "origin" types are the same, select the route with the lowest MED attribute. Unless activating command "bgp always-compare-med", this comparison is only available among the routes from the same neighbor AS.
7. If the MED attributes are the same, EBGP is preferable to outer confederation and outer confederation is preferable to IBGP.
8. If it's still the same by now, BGP router ID (router ID) is used to break the balance. The best route is the one from the least router ID.

9. If it's still the same by now, BGP router ID (router ID) is used to break the balance. The best route is the one from the least router ID.

39.2 BGP Configuration Task List

The BGP configuration tasks include basic and advanced tasks. Basic BGP configuration tasks include the following:

- 1 · Enable BGP Routing (required)
- 2 · Configure BGP Neighbors (required)
- 3 · Administrate the change of routing policy
- 4 · Configure BGP Weights
- 5 · Configure BGP Route Filtering policy basing on Neighbors
- 6 · Configure Next-Hop of BGP
- 7 · Configure Multi-Hop of EGBP
- 8 · Configure BGP Session Identifier
- 9 · Configure BGP Version

Advanced BGP configuration tasks include the following:

- 1 · Use Route Maps to Modify Route
- 2 · Configure Route Aggregation
- 3 · Configure BGP Community Filtering
- 4 · Configure BGP Confederation
- 5 · Configure a Route Reflector
- 6 · Configure Peer Groups
- 7 · Configure Neighbors and Peer Groups' Parameters
- 8 · Adjust BGP Timers
- 9 · Adjust BGP Announcement Interval
- 10 · Configure the default Local Priority
- 11 · Allow to Transfer Default Route
- 12 · Configure BGP's MED Value
- 13 · Configure BGP Routing Redistribution
- 14 · Configure BGP Route Dampening
- 15 · Configure BGP capability Negotiation
- 16 · Configure Routing Server
- 17 · Configure Path-Selected Rule
- 18 · Configure redistribution of OSPF routing to BGP
 - (1) Enable redistribution of OSPF routing to BGP
 - (2) Display and debug the information about configuration of redistribution of OSPF routing to BGP

I · Basic BGP configuration tasks

1. Enable BGP Routing

Command	Explanation
Global mode	
router bgp <as-id> no router bgp <as-id>	Enable BGP, the “no router bgp <as-id>”command disenable BGP process.
Router configuration mode	
network <ip-address/M> no network <ip-address/M>	Set the network that BGP will announce, the no network <ip-address/M> command cancels the network that will be announced.

2. Configure BGP Neighbors

Command	Explanation
Router configuration mode	
neighbor {<ip-address> <TAG>} remote-as <as-id> no neighbor {<ip-address> <TAG>} [remote-as <as-id>]	Specify a BGP neighbor, the no neighbor {<ip-address> <TAG> [remote-as <as-id>] command deletes the neighbor.

3. Administer the change of routing policy

(1) Configure hard reconfiguration.

Command	Explanation
Admin Mode	
clear ip bgp {<*> <as-id> external peer-group <NAME> <ip-address>}	Configure hard reconfiguration.

(2) Configure outbound soft reconfiguration.

Command	Explanation
Admin Mode	
clear ip bgp {<*> <as-id> external peer-group <NAME> <ip-address>} soft out	Configure outbound soft reconfiguration.

(3) Configure inbound soft reconfiguration.

Command	Explanation
BGP configuration mode	
neighbor { <ip-address> <TAG> } soft-reconfiguration inbound no neighbor { <ip-address> <TAG> } soft-reconfiguration inbound	This command can store routing information from neighbors and peers; the no neighbor { <ip-address> <TAG> } soft-reconfiguration inbound command cancels the storage of routing information.
Admin Mode	

clear ip bgp {<*>/<as-id> external peer-group <NAME> <ip-address>} soft in	Configure BGP inbound soft reconfiguration.
--	---

4. Configure BGP Weights

Command	Explanation
BGP configuration mode	
neighbor { <ip-address> <TAG> } weight <weight> no neighbor { <ip-address> <TAG> }	Configure BGP neighbor weights; the no neighbor { <ip-address> <TAG> } command recovers default weights.

5. Configure BGP Route Filtering policy based on neighbor

Command	Explanation
BGP configuration mode	
neighbor {<ip-address>/<TAG>} distribute-list {<1-199>/<1300-2699>/<WORD>} {in out} no neighbor {<ip-address>/<TAG>} distribute-list {<1-199>/<1300-2699>/<WORD>} {in out}	Filter neighbor routing updating information. The no neighbor {<ip-address> / <TAG>} distribute-list {<1-199>/<1300-2699>/ <WORD>} {in out} command cancels routing filter.

6. Configure Next-Hop

1) Set Next-Hop as the switch's address

Command	Explanation
BGP configuration mode	
neighbor { <ip-address> <TAG> } next-hop-self no neighbor { <ip-address> <TAG> } next-hop-self	While sending route Next-Hop set Next-Hop as the switch's address; the no neighbor { <ip-address> <TAG> } next-hop-self command cancels the setting.

2) Cancel default Next-Hop through route map

Command	Explanation
Route mapped configuration command	
set ip next-hop <ip-address> no set ip next-hop	Set the Next-Hop attribute of outbound route. The no set ip next-hop command cancels this setting.

7. Configure EGBP Multi-Hop

If the connections with outer neighbors are not direct, the following command can configure neighbor Multi-Hop.

Command	Explanation
BGP configuration mode	
neighbor {<ip-address>/<TAG>} ebgp-multihop	Configure the allowance of EGBP

[<1-255> no neighbor {<ip-address>/<TAG>} ebgp-multihop [<1-255>]	connection with other networks that are not connected directly; the no neighbor {<ip-address>/<TAG>} ebgp-multihop [<1-255>] command cancels the setting.
---	---

8. Configure BGP session identifier

Command	Explanation
BGP configuration mode	
bgp router-id <ip-address> no bgp router-id	Configure the router-id value; the no bgp router-id command recovers the default value.

9. Configure the BGP Version

Command	Explanation
BGP configuration mode	
neighbor {<ip-address> / <TAG>} version <value> no neighbor {<ip-address> / <TAG>} version	Set the version used by BGP neighbors; the no neighbor {<ip-address> / <TAG>} version command recovers default setting. Presently only supporting version 4 th .

II · Advanced BGP configuration tasks

1 · Use Route Maps to Modify Route

Command	Explanation
BGP configuration mode	
neighbor { <ip-address> / <TAG> } route-map <map-name> {in out} no neighbor { <ip-address> / <TAG> } route-map <map-name> {in out}	Apply a route map to incoming or outgoing routes; the no neighbor { <ip-address> / <TAG> } route-map <map-name> {in out} command cancels the settings of routing maps.

2 · Configure Route Aggregation

Command	Explanation
BGP configuration mode	
aggregate-address <ip-address/M> [summary-only] [as-set] no aggregate-address <ip-address/M> [summary-only] [as-set]	Create an aggregate entry in the BGP routing table; the no aggregate-address <ip-address/M> [summary-only] [as-set] command cancels the aggregate entry.

3 · Configure BGP Community Filtering

Command	Explanation
BGP configuration mode	
neighbor {<ip-address> / <TAG>} send-community no neighbor {<ip-address> / <TAG>} send-community	Allow the routing updates with community attributes sending to BGP neighbors; the no neighbor {<ip-address> / <TAG>} send-community command enables the route without community attributes.

4 · Configure BGP Confederation

Command	Explanation
BGP configuration mode	
bgp confederation identifier <as-id> no bgp confederation identifier <as-id>	Configure a BGP AS confederation identifier; the no bgp confederation identifier <as-id> command deletes the BGP AS confederation identifier.
bgp confederation peers <as-id> [<as-id>..] no bgp confederation peers <as-id> [<as-id>..]	Configure the AS affiliated to the AS confederation; the no bgp confederation peers <as-id> [<as-id>..] command deletes the AS from the AS confederation.

5 · Configure a Route Reflector

- (1) The following commands can be used to configure route reflector and its clients.

Command	Explanation
BGP configuration mode	
neighbor <ip-address> route-reflector-client no neighbor <ip-address> route-reflector-client	Configure the current switch as route reflector and specify a client. the no neighbor <ip-address> route-reflector-client commands format deletes a client.

- (2) If there are more than one route reflectors in the cluster, the following commands can configure cluster-id.

Command	Explanation
BGP configuration mode	
bgp cluster-id <cluster-id> no bgp cluster-id	Configure cluster id; format “no” of the no bgp cluster-id command cancels the cluster id configuration.

- (3) If the route reflector from clients to clients is needed, the following commands can be used.

Command	Explanation
BGP configuration mode	
bgp client-to-client reflection no bgp client-to-client reflection	Configure the allowance of the route reflector from clients to clients; the no bgp client-to-client reflection command forbids this allowance.

6 · Configure Peer Groups

- (1) Create peer groups

Command	Explanation
BGP configuration mode	
neighbor <TAG> peer-group no neighbor <TAG> peer-group	Create peer groups; the no neighbor <TAG> peer-group command deletes peer groups.

- (2) Add neighbors to peers groups

Command	Explanation
BGP configuration mode	
neighbor <ip-address> peer-group <TAG> no neighbor <ip-address> peer-group <TAG>	Make a neighbor a member of the peer group. The no neighbor <ip-address> peer-group <TAG> command cancels the specified member.

7 · Configure neighbors and peer Groups' parameters

Command	Explanation
BGP configuration mode	
neighbor { <ip-address> / <TAG> } remote-as <as-id> no neighbor { <ip-address> / <TAG> } remote-as <as-id>	Specify a BGP neighbor; format “no” of the no neighbor { <ip-address> / <TAG> } remote-as <as-id> command deletes the neighbor.
neighbor { <ip-address> / <TAG> } description <.LINE> no neighbor { <ip-address> / <TAG> } description	Associate a description with a neighbor; the no neighbor { <ip-address> / <TAG> } description command deletes this description.

<pre>neighbor { <ip-address> / <TAG> } default-originate [route-map <NAME>] no neighbor { <ip-address> / <TAG> } default-originate [route-map <NAME>]</pre>	<p>Permit to send the default route 0.0.0.0; the no neighbor { <ip-address> / <TAG> } default-originate [route-map <NAME>] command cancels sending default route.</p>
<pre>neighbor { <ip-address> / <TAG> } send-community no neighbor { <ip-address> / <TAG> } send-community</pre>	<p>Configure the community attributes sent to the neighbor.</p>
<pre>neighbor { <ip-address> / <TAG> } timers <keep alive> <holdtime> no neighbor { <ip-address> / <TAG> } timers</pre>	<p>Configure a particular neighbor's keep-alive and hold-time timer; the no neighbor { <ip-address> / <TAG> } timers command recovers the default value.</p>
<pre>neighbor { <ip-address> / <TAG> } advertisement-interval <seconds> no neighbor { <ip-address> / <TAG> } advertisement-interval</pre>	<p>Configure the min interval of sending BGP routing information; the no neighbor { <ip-address> / <TAG> } advertisement-interval command recovers the default value.</p>
<pre>neighbor { <ip-address> / <TAG> } ebgp-multihop [<1-255>] no neighbor { <ip-address> / <TAG> } ebgp-multihop</pre>	<p>Configure the allowance of EBGp connections with networks connected indirectly; the no neighbor { <ip-address> / <TAG> } ebgp-multihop command cancels this setting.</p>
<pre>neighbor { <ip-address> / <TAG> } weight <weight> no neighbor { <ip-address> / <TAG> } weight</pre>	<p>Configure BGP neighbor weights; the no neighbor { <ip-address> / <TAG> } weight command recovers the default weights.</p>
<pre>neighbor { <ip-address> / <TAG> } distribute-list { <access-list-number> <name> } { in out } no neighbor { <ip-address> / <TAG> } distribute-list { <access-list-number> <name> } { in out }</pre>	<p>Filter neighbor route update; format "no" of the no neighbor { <ip-address> / <TAG> } distribute-list { <access-list-number> <name> } { in out } command cancels route filtering.</p>
<pre>neighbor { <ip-address> / <TAG> } route-reflector-client no neighbor { <ip-address> / <TAG> } route-reflector-client</pre>	<p>Configure the current switch as route reflector and specify a client; the no neighbor { <ip-address> / <TAG> } route-reflector-client command deletes a client.</p>
<pre>neighbor { <ip-address> / <TAG> } next-hop-self</pre>	<p>When sending route, configure</p>

no neighbor { <ip-address> / <TAG> } next-hop-self	Next-Hop as its address; the no neighbor { <ip-address> / <TAG> } next-hop-self command cancels the setting.
neighbor { <ip-address> / <TAG> } version <value> no neighbor { <ip-address> / <TAG> } version	Specify the BGP version communicating with BGP neighbors; the no neighbor { <ip-address> / <TAG> } version command recovers default setting.
neighbor { <ip-address> / <TAG> } route-map <map-name> {in out} no neighbor { <ip-address> / <TAG> } route-map <map-name> {in out}	Apply a route map to incoming or outgoing routes; the no neighbor { <ip-address> / <TAG> } route-map <map-name> {in out} command cancels the setting of route reflector.
neighbor { <ip-address> / <TAG> } soft-reconfiguration inbound no neighbor { <ip-address> / <TAG> } soft-reconfiguration inbound	Store the route information from neighbor or peers; the no neighbor { <ip-address> / <TAG> } soft-reconfiguration inbound command cancels the storage.
neighbor { <ip-address> / <TAG> } shutdown no neighbor { <ip-address> / <TAG> } shutdown	Shutdown BGP neighbor or peers; the no neighbor { <ip-address> / <TAG> } shutdown command activates the closed BGP neighbor or peers.

8 · Adjust BGP Timers

(1) Configure the BGP timer of all the neighbors

Command	Explanation
BGP configuration mode	
timers bgp <keep alive> <holdtime> no timers bgp	Configure the BGP timers of all the neighbors; the no timer bgp command recovers the default value.

(2) Configure the timer value of a particular neighbor

Command	Explanation
BGP configuration mode	
neighbor { <ip-address> / <TAG> } timers <keep alive> <holdtime> no neighbor { <ip-address> / <TAG> } timers	Configure the keep alive and holdtime timer of a particular neighbor; the no neighbor { <ip-address> / <TAG> } timers command recovers the default value.

9 · Adjust BGP announcement Interval

Command	Explanation
BGP configuration mode	
neighbor {<ip-address> / <TAG>} advertisement-interval <seconds> no neighbor {<ip-address> / <TAG>} advertisement-interval	Configure the minimum interval among BGP routes update information; the no neighbor {<ip-address> / <TAG>} advertisement-interval command recovers the default setting.

10 · Configure the Local Preference Value

Command	Explanation
BGP configuration mode	
bgp default local-preference <value> no bgp default local-preference	Change default local preference; the no bgp default local-preference command recovers the default value.

11 · Enable sending default route

Command	Explanation
BGP configuration mode	
neighbor { <ip-address> / <TAG> } default-originate no neighbor { <ip-address> / <TAG> } default-originate	Permit sending default route 0.0.0.0; the no neighbor { <ip-address> / <TAG> } default-originate command cancels sending default route.

12 · Configure BGP's MED Value

(1) Configure MED value

Command	Explanation
Route map configuration command	
set metric <metric-value> no set metric	Configure metric value; the no set metric command recovers the default value.

(2) Apply route selection based on MED according to the path from different AS

Command	Explanation
BGP configuration mode	
bgp always-compare-med no bgp always-compare-med	Permit the MED comparison from different AS; the no bgp always-compare-med command forbids the comparison.

13 · Configure BGP routing redistribution

Command	Explanation
BGP configuration mode	
redistribute { connected static rip ospf } [metric <metric>] [route-map <NAME>] no redistribute { connected static rip ospf }	Redistribute IGP routes to BGP and may specify the redistributed metric and route reflector; the no redistribute { connected static rip ospf } command cancels the redistribution.

14 · Configure Route Dampening

Command	Explanation
BGP configuration mode	
bgp dampening [<1-45>] [<1-20000> <1-20000> <1-255>] [<1-45>] no bgp dampening	Enable BGP route dampening and apply the specified parameters; the no bgp dampening command stops route dampening

15 · Configure BGP capability Negotiation

Command	Explanation
BGP configuration mode	
neighbor {<ip-address>/<TAG>} capability {dynamic route-refresh} no neighbor {<ip-address>/<TAG>} capability {dynamic route-refresh} neighbor {<ip-address>/<TAG>} capability orf prefix-list {<both>/<send>/<receive>} no neighbor {<ip-address>/<TAG>} capability orf prefix-list {<both>/<send>/<receive>} neighbor {<ip-address>/<TAG>} dont-capability-negotiate no neighbor {<ip-address>/<TAG>} dont-capability-negotiate neighbor {<ip-address>/<TAG>} override-capability no neighbor {<ip-address>/<TAG>} override-capability neighbor {<ip-address>/<TAG>} strict-capability-match no neighbor {<ip-address>/<TAG>} strict-capability-match	BGP provides capability negotiation regulation and carry out this capability match while establishing connection. The currently supported capabilities include route update, dynamic capability, outgoing route filtering capability and the address family's capability of supporting the negotiation. Use these command to enable these capabilities, its format "no" close these capabilities .It can also be configured by commands to not do capability negotiation, do strict capability negotiation or not care about the negotiation results.

16 · Configure Routing Server

Command	Explanation
BGP configuration mode	
neighbor {<ip-address>/<TAG>} route-server-client no neighbor {<ip-address>/<TAG>} route-server-client	Route server may configure BGP neighbors under EBGp environment to reduce the number of peers that every client has configured; format “no” of the command configures this router as route server and specify the clients it serves, the no neighbor {<ip-address>/<TAG>} route-server-client command can delete clients.

17 · Configure Path-selected rules

Command	Explanation
BGP configuration mode	
bgp always-compare-med no bgp always-compare-med bgp bestpath as-path ignore no bgp bestpath as-path ignore bgp bestpath compare-confed-aspath no bgp bestpath compare-confed-aspath bgp bestpath compare-routerid no bgp bestpath compare-routerid bgp bestpath med {[confed] [missing-is-worst]} no bgp bestpath med {[confed] [missing-is-worst]}	BGP may change some path-select rules by configuration to change the best selection and compare MED under EBGp environment through these command, ignore the AS-PATH length, compare the confederation as-path length, compare the route identifier and compare the confederation MED etc. Its format “no” recovers the default route path-selected rules.

18. Configure redistribution of OSPF routing to BGP

(1) Enable redistribution of OSPF routing to BGP

Command	Explanation
Router BGP Configuration Mode	
redistribute ospf [<process-id>] [route-map<word>] no redistribute ospf [<process-id>]	To enable or disable the redistribution of OSPF routing to BGP.

(2) Display and debug the information about configuration of redistribution of OSPF routing to BGP

Command	Explanation
Admin Mode and Configuration Mode	
show ip bgp redistribute	To enable or disable the redistribution of OSPF routing to BGP.
Admin Mode	

```

debug bgp redistribute message send
no debug bgp redistribute message
send
debug bgp redistribute route receive
no debug bgp redistribute route
receive

```

To enable or disable debugging messages sent by BGP for redistributing OSPF routing.
To enable or disable debugging messages received from NSM for redistributing OSPF routing.

39.3 Configuration Examples of BGP

39.3.1 Example 1: configure BGP neighbor

SwitchB, SwitchC and SwitchD are in AS200, and SwitchA is in AS100. SwitchA and SwitchB share the same network segment. SwitchB and SwitchD are not connected physically.

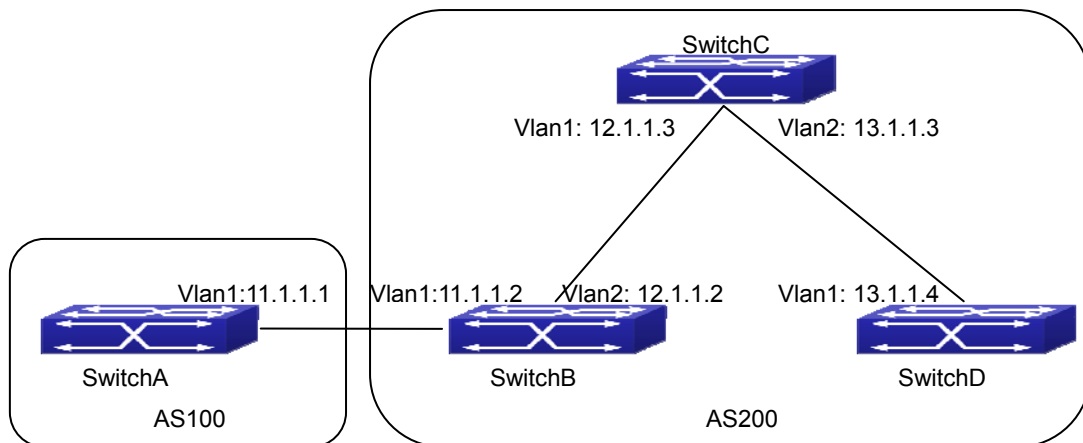

Figure 39-3-1 BGP Network Topological Map

The configurations of SwitchA are as follows:

```

SwitchA(config)#router bgp 100
SwitchA(config-router-bgp)#neighbor 11.1.1.2 remote-as 200
SwitchA(config-router-bgp)#exit

```

The configurations of SwitchB are as follows:

```

SwitchB(config)#router bgp 200
SwitchB(config-router-bgp)#network 11.0.0.0
SwitchB(config-router-bgp)#network 12.0.0.0
SwitchB(config-router-bgp)#network 13.0.0.0
SwitchB(config-router-bgp)#neighbor 11.1.1.1 remote-as 100
SwitchB(config-router-bgp)#neighbor 12.1.1.3 remote-as 200
SwitchB(config-router-bgp)#neighbor 13.1.1.4 remote-as 200
SwitchB(config-router-bgp)#exit

```

The configurations of SwitchC are as follows:

```
SwitchC(config)#router bgp 200
SwitchC(config-router-bgp)#network 12.0.0.0
SwitchC(config-router-bgp)#network 13.0.0.0
SwitchC(config-router-bgp)#neighbor 12.1.1.2 remote-as 200
SwitchC(config-router-bgp)#neighbor 13.1.1.4 remote-as 200
SwitchC(config-router-bgp)#exit
```

The configurations of SwitchD are as follows:

```
SwitchD(config)#router bgp 200
SwitchD(config-router-bgp)#network 13.0.0.0
SwitchD(config-router-bgp)#neighbor 12.1.1.2 remote-as 200
SwitchD(config-router-bgp)#neighbor 13.1.1.3 remote-as 200
SwitchD(config-router-bgp)#exit
```

Presently, the connection between SwitchB and SwitchA is EBGP, and other connections with SwitchC and SwitchD are IBGP. SwitchB and SwitchD may have BGP connection without physical connection. But there is a precondition that these two switches must have reachable route to each other. This route can be attained through static route or IGP.

39.3.2 Example 2: configure BGP aggregation

In this sample, configure route aggregation. Firstly, enable command redistribute to redistribute static route to BGP route table:

```
SwitchB(config)#ip route 193.0.0.0/24 11.1.1
SwitchB(config)#router bgp 100
SwitchB(config-router-bgp)#redistribute static
```

When there is at least one route affiliated to the specified range, the following configuration will create an aggregation route in the BGP route table. The aggregation route will be regarded as the AS from itself. More detailed route information about 193.0.0.0 will be announced.

```
SwitchB(config)#router bgp 100
SwitchB(config-router-bgp)#aggregate 193.0.0.0/16
```

At the same time, the aggregation command above can be modified as follows, then this switch only announce aggregation route 193.0.0.0 and forbid to announce more specified route to all the neighbors.

```
SwitchB(config-router-bgp)#aggregate 193.0.0.0/16 summary-only
```

39.3.3 Example 3: configure BGP community attributes

In the following sample, “route map set-community” is used for the outgoing update to neighbor 16.1.1.6. By accessing to route in table 1 to configure special community value to “1111”, other can be announced normally.

```
XGS3-42000R(config)#router bgp 100
XGS3-42000R(config-router-bgp)#neighbor 16.1.1.6 remote-as 200
XGS3-42000R(config-router-bgp)#neighbor 16.1.1.6 route-map set-community out
XGS3-42000R(config-router-bgp)#exit
XGS3-42000R(config)#route-map set-community permit 10
XGS3-42000R(config-route-map)#match address 1
XGS3-42000R(config-route-map)#set community 1111
XGS3-42000R(config-route-map)#exit
XGS3-42000R(config)#route-map set-community permit 20
XGS3-42000R(config-route-map)#match address 2
XGS3-42000R(config-route-map)#exit
XGS3-42000R(config)#access-list 1 permit 11.1.0.0 0.0.255.255
XGS3-42000R(config)#access-list 2 permit 0.0.0.0 255.255.255.255
XGS3-42000R(config)#exit
XGS3-42000R#clear ip bgp 16.1.1.6 soft out
```

In the following sample, configure the MED local preference of the routes from neighbor 16.1.1.6 selectively according to the route community value. All the routes that match the community list will set MED as 2000, community list com1 permits the route with community value “100 200 300”or”900 901” to pass. This route may have other community attributes. All the routes that pass community list com2 will set the local preference as 500. But the route that can’t pass both com1 and com2 will be rejected.

```
XGS3-42000R(config)#router bgp 100
XGS3-42000R(config-router-bgp)#neighbor 16.1.1.6 remote-as 200
XGS3-42000R(config-router-bgp)#neighbor 16.1.1.6 route-map match-community in
XGS3-42000R(config-router-bgp)#exit
XGS3-42000R(config)#route-map match-community permit 10
XGS3-42000R(config-route-map)#match community com1
XGS3-42000R(config-route-map)#set metric 2000
XGS3-42000R(config-route-map)#exit
XGS3-42000R(config)#route-map match-community permit 20
XGS3-42000R(config-route-map)#match community com2
XGS3-42000R(config-route-map)#set local-preference 500
XGS3-42000R(config-route-map)#exit
XGS3-42000R(config)#ip community-list com1 permit 100 200 300
XGS3-42000R(config)#ip community-list com1 permit 900 901
XGS3-42000R(config)#ip community-list com2 permit 88
XGS3-42000R(config)#ip community-list com2 permit 90
XGS3-42000R(config)#exit
XGS3-42000R#clear ip bgp 16.1.1.6 soft out
```

39.3.4 Example 4: configure BGP confederation

The following is the configuration of an AS. As the picture illustrated, SwitchB and SwitchC establish IBGP connection. SwitchD is affiliated to AS 20. SwitchB and SwitchC establish EBGP of inner AS confederation. AS10 and AS20 form AS confederation with the AS number AS200; SwitchA belongs to AS100, SwitchB may create EBGP connection by AS200.

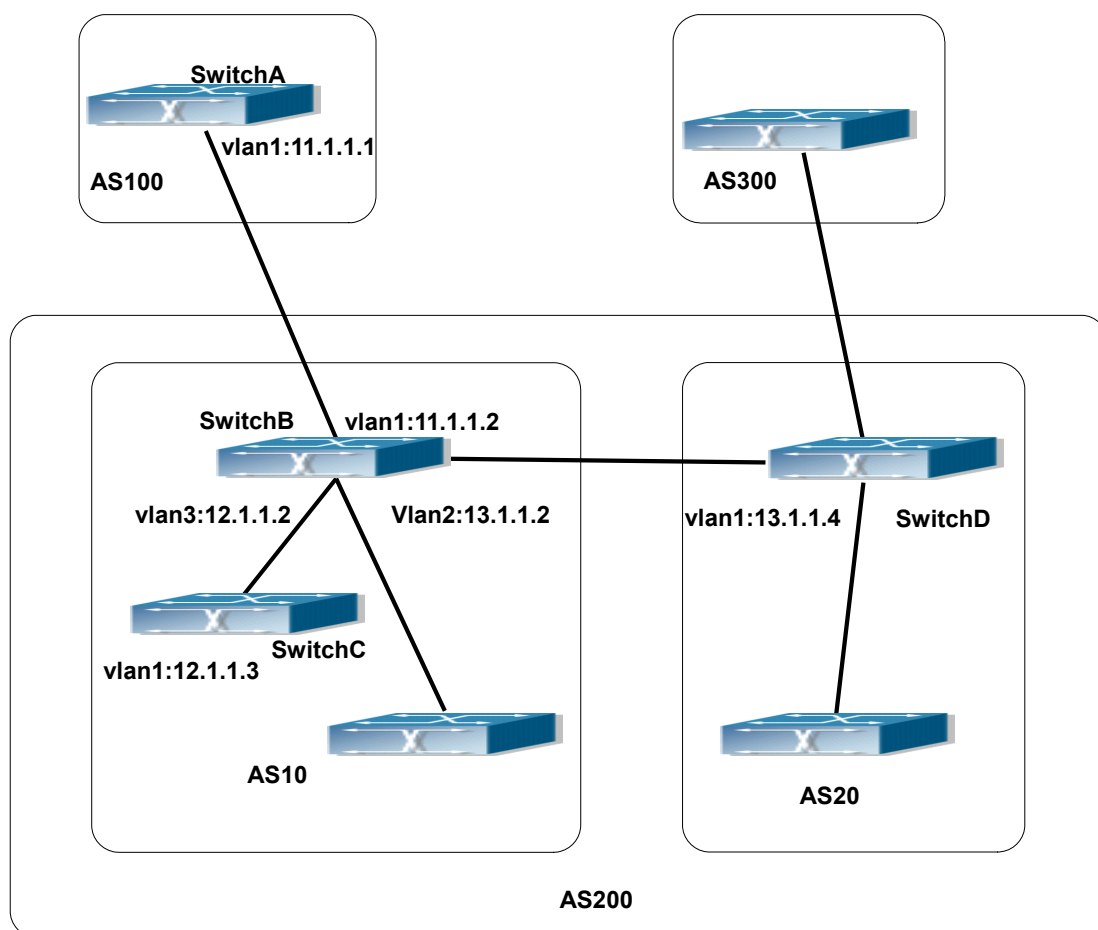

Figure 39-3-2 Confederation configuring topology

The configurations are as follows:

SwitchA:

```
SwitchA(config)#router bgp 100
SwitchA(config-router-bgp)#neighbor 11.1.1.2 remote-as 200
```

SwitchB:

```
SwitchB(config)#router bgp 10
SwitchB(config-router-bgp)#bgp confederation identifier 200
SwitchB(config-router-bgp)#bgp confederation peers 20
SwitchB(config-router-bgp)#neighbor 12.1.1.3 remote-as 10
```

```
SwitchB(config-router-bgp)#neighbor 13.1.1.4 remote-as 20
SwitchB(config-router-bgp)#neighbor 11.1.1.1 remote-as 100
```

SwitchC:

```
SwitchC(config)#router bgp 10
SwitchC(config-router-bgp)#bgp confederation identifier 200
SwitchC(config-router-bgp)#bgp confederation peers 20
SwitchC(config-router-bgp)#neighbor 12.1.1.2 remote-as 10
```

SwitchD:

```
SwitchD(config)#router bgp 20
SwitchD(config-router-bgp)#bgp confederation identifier 200
SwitchD(config-router-bgp)#bgp confederation peers 10
SwitchD(config-router-bgp)#neighbor 13.1.1.2 remote-as 10
```

39.3.5 Examples 5: configure BGP route reflector

The following is the configuration of a route reflector. As the picture illustrated, SwitchA, SwitchB, SwitchC, SwitchD, SWE, SWF and SWG establish IBGP connection which is affiliated to AS100. SwitchC creates EBGP connection with AS200. SwitchA creates EBGP connection with AS300. SwitchC, SwitchD and SWG make route reflectors.

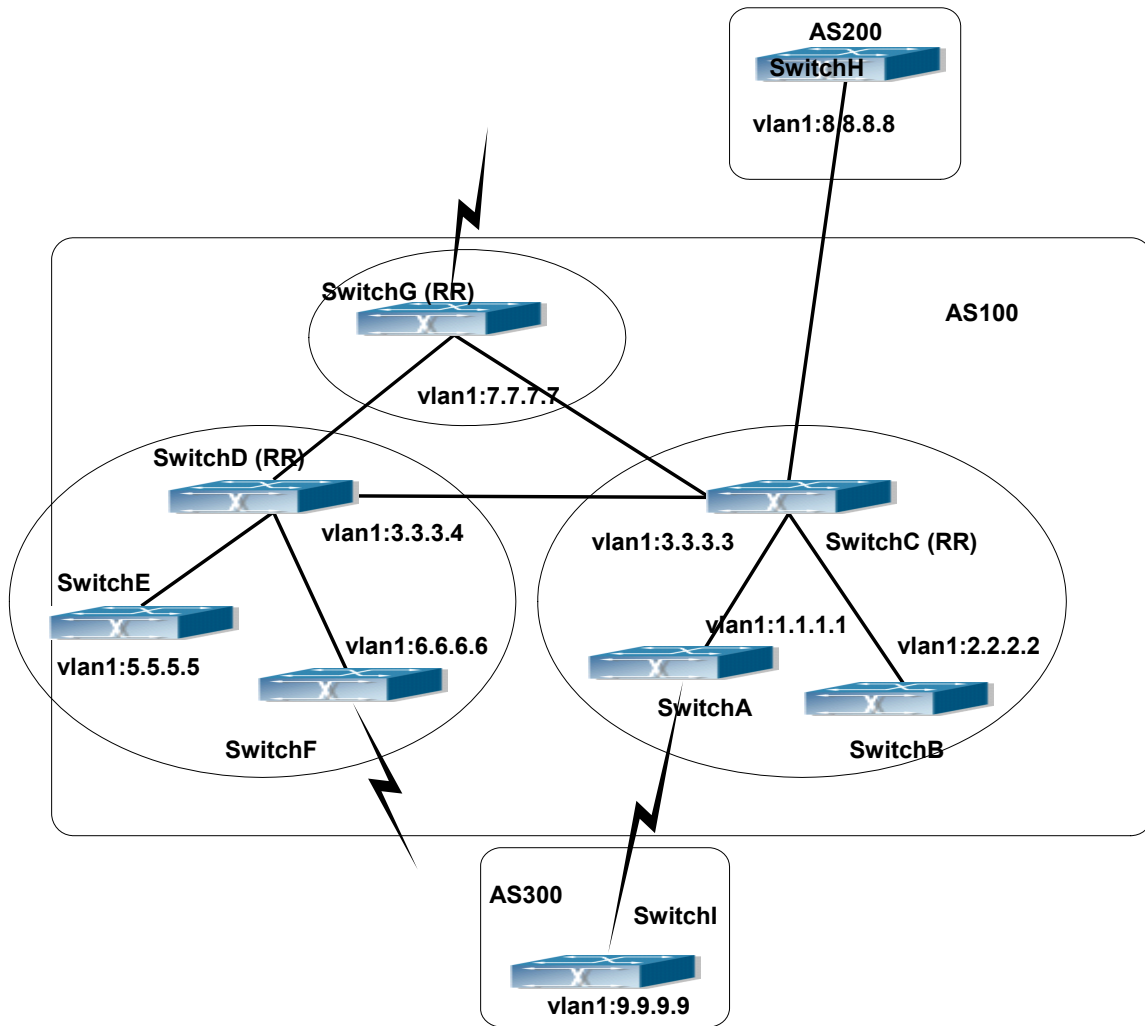

Figure 39-3-3 the Topological Map of Route Reflector

The configurations are as follows:

The configurations of SwitchC:

```
SwitchC(config)#router bgp 100
SwitchC(config-router-bgp)#neighbor 1.1.1.1 remote-as 100
SwitchC(config-router-bgp)#neighbor 1.1.1.1 route-reflector-client
SwitchC(config-router-bgp)#neighbor 2.2.2.2 remote-as 100
SwitchC(config-router-bgp)#neighbor 2.2.2.2 route-reflector-client
SwitchC(config-router-bgp)#neighbor 7.7.7.7 remote-as 100
SwitchC(config-router-bgp)#neighbor 3.3.3.4 remote-as 100
SwitchC(config-router-bgp)#neighbor 8.8.8.8 remote-as 200
```

The configurations of SwitchD:

```
SwitchD(config)#router bgp 100
SwitchD(config-router-bgp)#neighbor 5.5.5.5 remote-as 100
SwitchD(config-router-bgp)#neighbor 5.5.5.5 route-reflector-client
SwitchD(config-router-bgp)#neighbor 6.6.6.6 remote-as 100
SwitchD(config-router-bgp)#neighbor 6.6.6.6 route-reflector-client
SwitchD(config-router-bgp)#neighbor 3.3.3.3 remote-as 100
SwitchD(config-router-bgp)#neighbor 7.7.7.7 remote-as 100
```

The configurations of SwitchA:

```
SwitchA(config)#router bgp 100
SwitchA(config-router-bgp)#neighbor 1.1.1.2 remote-as 100
SwitchA(config-router-bgp)#neighbor 9.9.9.9 remote-as 300
```

SwitchA at this time needn't to create IBGP connection with all the switches in the AS100 and could receive BGP route from other switches in the AS.

39.3.6 Example 6: configure MED of BGP

The following is the configuration of an MED. As illustrated, SwitchA is affiliated to AS100, SwitchB is affiliated to AS400, and SwitchC and SwitchD belong to AS300.

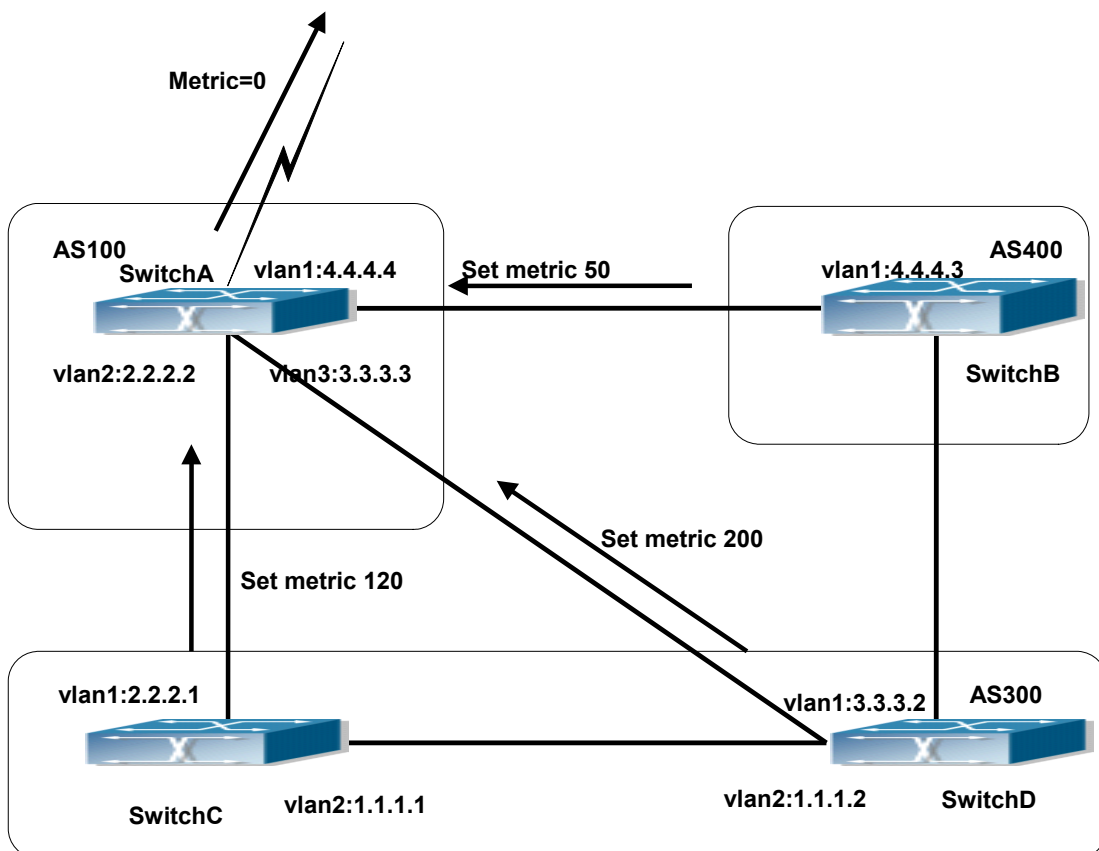

Figure 39-3-4 MED Configuring Topological Map

The configurations of SwitchA:

```
SwitchA(config)#router bgp 100
SwitchA(config-router-bgp)#neighbor 2.2.2.1 remote-as 300
SwitchA(config-router-bgp)#neighbor 3.3.3.2 remote-as 300
SwitchA(config-router-bgp)#neighbor 4.4.4.3 remote-as 400
```

The configurations of SwitchC:

```
SwitchC(config)#router bgp 300
SwitchC (config-router-bgp)#neighbor 2.2.2.2 remote-as 100
SwitchC (config-router-bgp)#neighbor 2.2.2.2 route-map set-metric out
SwitchC (config-router-bgp)#neighbor 1.1.1.2 remote-as 300
SwitchC (config-router-bgp)#exit
SwitchC (config)#route-map set-metric permit 10
SwitchC (Config-Router-RouteMap)#set metric 120
```

The configurations of SwitchD

```
SwitchD (config)#router bgp 300
SwitchD (config-router-bgp)#neighbor 3.3.3.3 remote-as 100
SwitchD (config-router-bgp)#neighbor 3.3.3.3 route-map set-metric out
SwitchD (config-router-bgp)#neighbor 1.1.1.1 remote-as 300
SwitchD (config-router-bgp)#exit
SwitchD (config)#route-map set-metric permit 10
SwitchD (Config-Router-RouteMap)#set metric 200
```

The configurations of SwitchB

```
SwitchB (config)#router bgp 400
SwitchB (config-router-bgp)#neighbor 4.4.4.4 remote-as 100
SwitchB (config-router-bgp)#neighbor 4.4.4.4 route-map set-metric out
SwitchB (config-router-bgp)#exit
SwitchB (config)#route-map set-metric permit 10
SwitchB (Config-Router-RouteMap)#set metric 50
```

After the above configuration is done, SwitchB, SwitchC and SwitchD are assumed to send a route 12.0.0.0 to SwitchA. According to the comparison of BGP route strategy, there is an assumption that the routes sent by the three switches above have the same attribute value before the comparison of metric attribute. At this time, the route with lower value is the better route. But the comparison of metric attribute will only be done with the routes from the same AS. For SwitchA, the routes that pass SwitchC are preferable to the one that passes SwitchD. Because SwitchC and SwitchB are not located in the same AS, SwitchA will not do metric comparison between the two switches. If the metric comparison between different AS is needed, the command "bgp always-compare-med" will be used. If this command is configured, the routes that pass SwitchB are the best to SwitchA. At this time, the following command may be added to SwitchA:

```
SwitchA (config-router-bgp)#bgp always-compare-med
```

39.3.7 Example 7: example of BGP VPN

For the configuration of MPLS VPN, BGP is part of the core routing system and it is also an important utility to support ILM and FTN entries on the edge devices. For DCNOS, the BGP protocol together with the LDP protocol constructs the foundation of the MPLS VPN application. The LDP protocol works at the WLAN side and for the routers which are not on the edge of the network, the BGP protocol does not function.

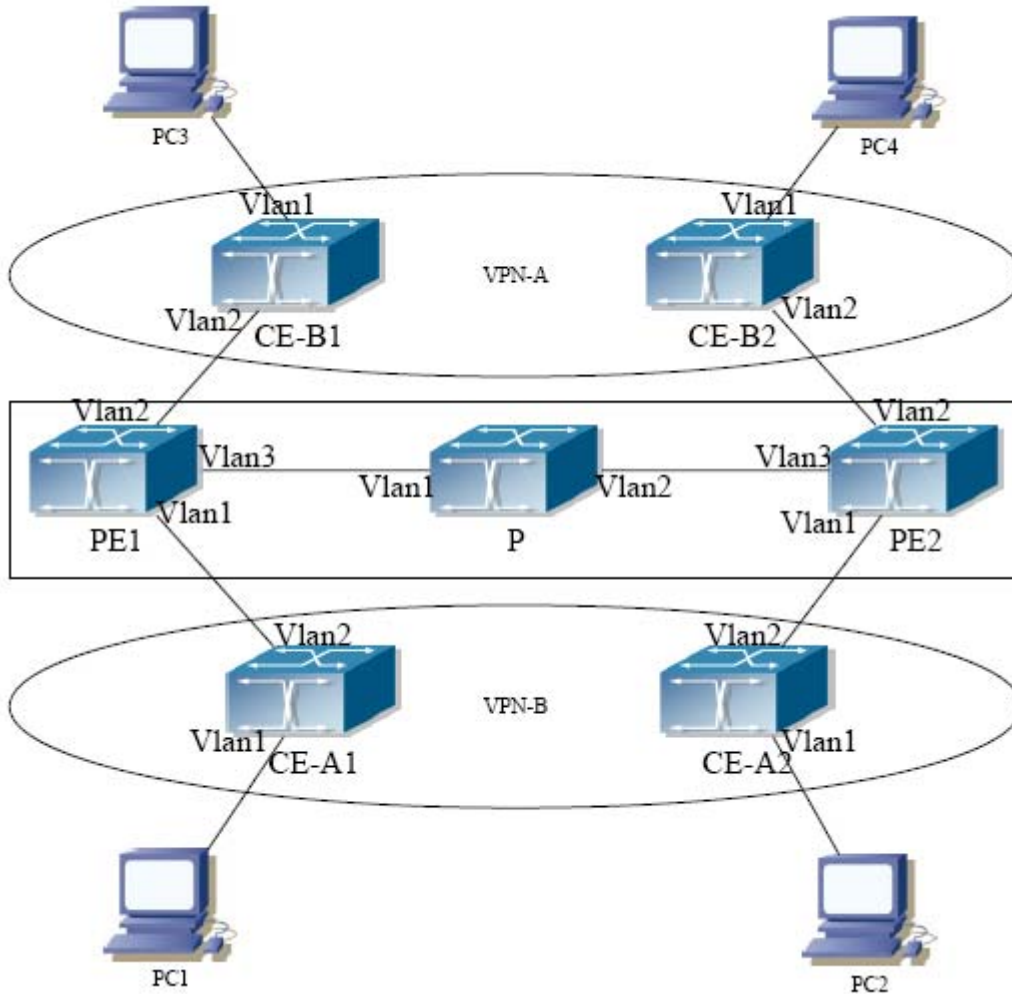

Figure 39-3-5 Example of MPLS VPN

As the figure shows, for a typical MPLS VPN application, the public network region consists of PE1, P and PE2, which MPLS is applied for packet transmission. VPN-A consists of CE-A1 and CE-A2, and VPN-B consists of CE-B1 and CE-B2. These two VPNs are isolated from each other. PE1 and PE2 are edge routers which are provided by the operators. CE-A1, CE-A2, CE-B1 and CE-B2 are the access switches on the user side. PC1-PC4 indicate the network users. BGP runs at both the public and private network region. For the public network region, VPN routing should be supported and the LOOPBACK interface should be used for connections.

The sample configurations are listed below.

Configurations on CE-A1 :

```
CE-A1#config
CE-A1(config)#interface vlan 2
CE-A1(config-if-Vlan2)#ip address 192.168.101.2 255.255.255.0
CE-A1(config-if-Vlan2)#exit
CE-A1(config)#interface vlan 1
CE-A1(config-if-Vlan2)#ip address 10.1.1.1 255.255.255.0
CE-A1(config-if-Vlan2)#exit
CE-A1(config)#router bgp 60101
CE-A1(config-router)#neighbor 192.168.101.1 remote-as 100
CE-A1(config-router)#exit
```

Configurations on CE-A2 :

```
CE-A2#config
CE-A2(config)#interface vlan 2
CE-A2(config-if-Vlan2)#ip address 192.168.102.2 255.255.255.0
CE-A2(config-if-Vlan2)#exit
CE-A2(config)#interface vlan 1
CE-A2(config-if-Vlan2)#ip address 10.1.2.1 255.255.255.0
CE-A2(config-if-Vlan2)#exit
CE-A2(config)#router bgp 60102
CE-A2(config-router)#neighbor 192.168.102.1 remote-as 100
CE-A2(config-router)#exit
```

Configurations on CE-B1 :

```
CE-B1#config
CE-B1(config)#interface vlan 2
CE-B1(config-if-Vlan2)#ip address 192.168.201.2 255.255.255.0
CE-B1(config-if-Vlan2)#exit
CE-B1(config)#interface vlan 1
CE-B1(config-if-Vlan2)#ip address 20.1.1.1 255.255.255.0
CE-B1(config-if-Vlan2)#exit
CE-B1(config)#router bgp 60201
CE-B1(config-router)#neighbor 192.168.201.1 remote-as 100
CE-B1(config-router)#exit
```

Configurations on CE-BE2 :

```
CE-B2#config
CE-B2(config)#interface vlan 2
CE-B2(config-if-Vlan2)#ip address 192.168.202.2 255.255.255.0
CE-B2(config-if-Vlan2)#exit
CE-B2(config)#interface vlan 1
```

```
CE-B2(config-if-Vlan2)#ip address 20.1.2.1 255.255.255.0
CE-B2(config-if-Vlan2)#exit
CE-B2(config)#router bgp 60202
CE-B2(config-router)#neighbor 192.168.202.1 remote-as 100
CE-B2(config-router)#exit
```

Configurations on PE1 :

```
PE1#config
PE1(config)#ip vrf VRF-A
PE1(config-vrf)#rd 100:10
PE1(config-vrf)#route-target both 100:10
PE1(config-vrf)#exit
PE1(config)#ip vrf VRF-B
PE1(config-vrf)#rd 100:20
PE1(config-vrf)#route-target both 100:20
PE1(config-vrf)#exit
PE1(config)#interface vlan 1
PE1(config-if-Vlan1)#ip vrf forwarding VRF-A
PE1(config-if-Vlan1)#ip address 192.168.101.1 255.255.255.0
PE1(config-if-Vlan1)#exit
PE1(config)#interface vlan 2
PE1(config-if-Vlan2)#ip vrf forwarding VRF-B
PE1(config-if-Vlan2)#ip address 192.168.201.1 255.255.255.0
PE1(config-if-Vlan2)#exit
PE1(config)#interface vlan 3
PE1(config-if-Vlan3)#ip address 202.200.1.2 255.255.255.0
PE1(config-if-Vlan3)#label-switching
PE1(config-if-Vlan3)#exit
PE1(config)#interface loopback 1
PE1(Config-if-Loopback1)# ip address 200.200.1.1 255.255.255.255
PE1(config-if-Vlan3)#exit
PE1(config)#router bgp 100
PE1(config-router)#neighbor 200.200.1.2 remote-as 100
PE1(config-router)#neighbor 200.200.1.2 update-source 200.200.1.1
PE1(config-router)#address-family vpnv4 unicast
PE1(config-router-af)#neighbor 200.200.1.2 activate
PE1(config-router-af)#exit-address-family
PE1(config-router)#address-family ipv4 vrf VRF-A
PE1(config-router-af)# neighbor 192.168.101.2 remote-as 60101
PE1(config-router-af)#exit-address-family
PE1(config-router)#address-family ipv4 vrf VRF-B
PE1(config-router-af)# neighbor 192.168.201.2 remote-as 60201
PE1(config-router-af)#exit-address-family
```

Configurations on PE2 :

```
PE2#config
PE2(config)#ip vrf VRF-A
PE2(config-vrf)#rd 100:10
PE2(config-vrf)#route-target both 100:10
PE2(config-vrf)#exit
PE2(config)#ip vrf VRF-B
PE2(config-vrf)#rd 100:20
PE2(config-vrf)#route-target both 100:20
PE2(config-vrf)#exit
PE2(config)#interface vlan 1
PE2(config-if-Vlan1)#ip vrf forwarding VRF-A
PE2(config-if-Vlan1)#ip address 192.168.102.1 255.255.255.0
PE2(config-if-Vlan1)#exit
PE2(config)#interface vlan 2
PE2(config-if-Vlan2)#ip vrf forwarding VRF-B
PE2(config-if-Vlan2)#ip address 192.168.202.1 255.255.255.0
PE2(config-if-Vlan2)#exit
PE2(config)#interface vlan 3
PE2(config-if-Vlan3)#ip address 202.200.2.2 255.255.255.0
PE2(config-if-Vlan3)#label-switching
PE2(config-if-Vlan3)#exit
PE2(config)#interface loopback 1
PE2(Config-if-Loopback1)# ip address 200.200.1.2 255.255.255.255
PE2(config-if-Vlan3)#exit
PE2(config)#router bgp 100
PE2(config-router)#neighbor 200.200.1.1 remote-as 100
PE2(config-router)#address-family vpnv4 unicast
PE2(config-router-af)#neighbor 200.200.1.1 activate
PE2(config-router-af)#exit-address-family
PE2(config-router)#address-family ipv4 vrf VRF-A
PE2(config-router-af)# neighbor 192.168.102.2 remote-as 60102
PE2(config-router-af)#exit-address-family
PE2(config-router)#address-family ipv4 vrf VRF-B
PE2(config-router-af)# neighbor 192.168.202.2 remote-as 60202
PE2(config-router-af)#exit-address-family
```

The sample configurations which are listed above is the most typical one. To enable communication between VRF, the route-target should be modified. And if the BGP AS number duplicates for the ends, the “**neighbor <ip-addr> as-override**” **command** should be configured to avoid the duplication of AS numbers.

Also, only BGP related configuration are listed above, to run LDP on the public network region, please refer to the LDP configuration sample.

39.4 BGP Troubleshooting

In the process of configuring and implementing BGP protocol and physical connection, configuration false probably leads to BGP protocol that doesn't work. Therefore, the customers should give their attention to the following points:

- First of all, ensure physical connection is correct;
- Secondly, ensure interface and link protocols are UP (execute **show interface** instruction);
- And startup BGP protocol (use **router bgp** command), configure affiliated IBGP and EBGP neighbors (use **neighbor remote-as** command).
- Notice BGP protocol itself can't detect route, needs to import other routes to create BGP route. Only it enables these routes to announce IBGP and EBGP neighbors by importing routes. Direct-link routes, static route, and IGP route (RIP and OSPF) are included in these imported routes. **network** and **redistribute (BGP)** command are the ways of imported routes.
- For BGP, pay attention to the difference between the behaviors of IBGP and EBGP.
- After configuration finishes, the command of **show ip bgp summary** can be used to observe neighbor's connections, so that all of the neighbors keep BGP connection situation. And use **show ip bgp** command to observe BGP routing table.
- If BGP routing problem still can't be solved by debugging, please use debug instructions like **debug ip bgp** packet/events, etc, and copy DEBUG information in 3 minutes, and then send them to our Technology Service Center.

Chapter 40 MBGP4+

40.1 Introduction to MBGP4+

MBGP4+ is multi-protocol BGP (Multi-protocol Border Gateway Protocol) extension to IPv6, referring to BGP protocol chapter about BGP protocol introduction in this manual. Different from RIPng and OSPFv3, BGP has no corresponding independent protocol for IPv6, instead, it takes extensions to address families on the original BGP. The extensions to BGP by MBGP4+ are mostly embodied:

- a. neighbor address configured can be IPv6 address;
- b. Increase IPv6 unicast address family configuration.

40.2 MBGP4+ Configuration Task List

MBGP4+ Configuration Task List::

1. Configure IPv6 neighbor
2. Configure and enable IPv6 address family
3. Configure redistribution of OSPFv3 routing to MBGP4+
 - 1) Enable redistribution of OSPFv3 routing to MBGP4+
 - 2) Display and debug the information about configuration of redistribution of OSPFv3 routing to MBGP4+

1. Configure IPv6 neighbor

Command	Explanation
BGP Protocol Configuration Mode	
neighbor <X:X::X:X> remote-as <as-id>	Configure IPv6 neighbor.

2. Configure and activate IPv6 address family

Command	Explanation
BGP Protocol Configuration Mode	
address-family IPv6 unicast	Enter IPv6 unicast address family.
BGP protocol address family configuration mode	
neighbor <X:X::X:X> activate no neighbor <X:X::X:X> activate	Configure IPv6 neighbor to activate/inactivate the address family.
exit-address-family	Exit address family configuration mode.

3. Configure redistribution of OSPFv3 routing to MBGP4+

(1) Enable redistribution of OSPFv3 routing to MBGP4+

Command	Explanation
Router IPv6 BGP Configuration Mode	
redistribute ospf [<process-tag>] [route-map<word>] no redistribute ospf [<process-tag>]	To enable or disable redistribution of OSPFv3 routing to MBGP4+.

(2) Display and debug the information about configuration of redistribution of OSPFv3 routing to MBGP4+

Command	Explanation
Admin Mode and Configuration Mode	
show ipv6 bgp redistribute	To display configuration information about MBGP4+ routing which is redistributed from other routing protocols.
Admin Mode	
debug ipv6 bgp redistribute message send no debug ipv6 bgp redistribute message send debug ipv6 bgp redistribute route receive no debug ipv6 bgp redistribute route receive	To enable or disable debugging messages sent by MBGP4+ for redistribution of OSPFv3 routing. To enable or disable debugging messages received from NSM.

40.3 MBGP4+ Examples

SwitchB, SwitchC and SwitchD are in AS200, and SwitchA is in AS100. SwitchA and SwitchB share the same network segment. SwitchB and SwitchD are not connected physically.

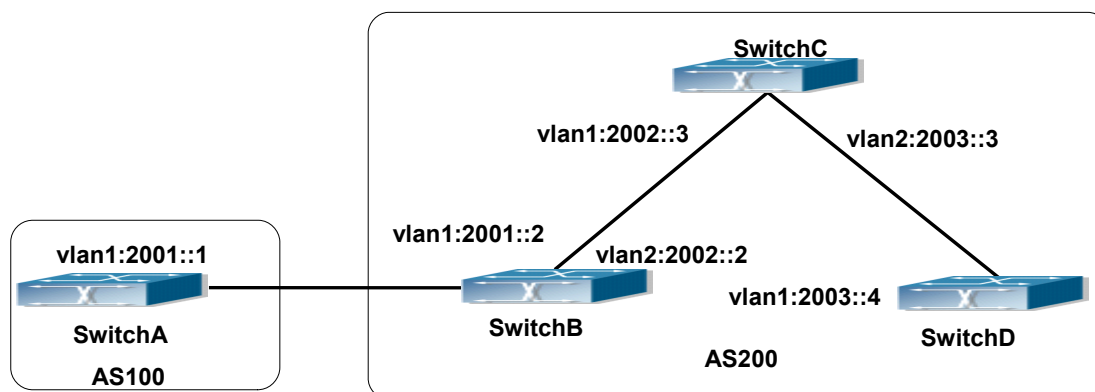

Figure 40-3-1 BGP Network Topological Map

Accordingly SwitchA configuration is as follows:

```
SwitchA(config)#router bgp 100
SwitchA(config-router)#bgp router-id 1.1.1.1
SwitchA(config-router)#neighbor 2001::2 remote-as 200
SwitchA(config-router)#address-family IPv6 unicast
SwitchA(config-router-af)#neighbor 2001::2 activate
SwitchA(config-router-af)#exit-address-family
SwitchA(config-router-bgp)#exit
SwitchA(config)#
```

SwitchB configuration is as follows:

```
SwitchB(config)#router bgp 200
SwitchA(config-router)#bgp router-id 2.2.2.2
SwitchB(config-router)#neighbor 2001::1 remote-as 100
SwitchB(config-router)#neighbor 2002::3 remote-as 200
SwitchB(config-router)#neighbor 2003::4 remote-as 200
SwitchB(config-router)#address-family IPv6 unicast
SwitchB(config-router-af)#neighbor 2001::1 activate
SwitchB(config-router-af)#neighbor 2002::3 activate
SwitchB(config-router-af)#neighbor 2003::4 activate
SwitchB(config-router-af)#exit-address-family
SwitchB(config-router)#exit
SwitchB(config)#
```

SwitchC configuration is as follows:

```
SwitchC(config)#router bgp 200
SwitchA(config-router)#bgp router-id 2.2.2.2
SwitchC(config-router)#neighbor 2002::2 remote-as 200
SwitchC(config-router)#neighbor 2003::4 remote-as 200
SwitchC(config-router)#address-family IPv6 unicast
SwitchC(config-router-af)#neighbor 2002::2 activate
SwitchC(config-router-af)#neighbor 2003::4 activate
SwitchC(config-router-af)#exit-address-family
SwitchC(config-router-bgp)#exit
```

SwitchD configuration is as follows:

```
SwitchD(config)#router bgp 200
SwitchA(config-router)#bgp router-id 2.2.2.2
SwitchD(config-router)#neighbor 2003::3 remote-as 200
SwitchD(config-router)#neighbor 2002::2 remote-as 200
SwitchD(config-router)#address-family IPv6 unicast
SwitchD(config-router-af)#neighbor 2002::2 activate
SwitchD(config-router-af)#neighbor 2003::3 activate
```

```
SwitchD(config-router-af)#exit-address-family
SwitchD(config-router)#exit
```

Here the connection between SwitchB and SwitchA is EBGP, and the connection between SwitchC and SwitchD is IBGP. The BGP connection can be processed between SwitchB and SwitchD without physical link, but the premise is a route which reaches from one switch to the other switch. The route can be obtained by static routing or IGP.

40.4 MBGP4+ Troubleshooting

It is the same as the corresponding section of BGP.

Chapter 41 Black Hole Routing Manual

41.1 Introduction to Black Hole Routing

Black Hole Routing is a special kind of static routing which drops all the datagrams that match the routing rule.

41.2 IPv4 Black Hole Routing Configuration Task

1. Configure IPv4 Black Hole Routing

Command	Explanation
Global Configuration Mode	
ip route {<ip-prefix> <mask>/<ip-prefix>/<prefix-length>} null0 [<distance>] no ip route {<ip-prefix> <mask>/<ip-prefix>/<prefix-length>} null0	To configure the static Black Hole Routing. The no form of this command will remove the specified Black Hole Routing configuration.

41.3 IPv6 Black Hole Routing Configuration Task

1. Enable the IPv6 function
2. Configure the IPv6 Black Hole Routing

1. Enable the IPv6 function

Command	Explanation
Global Configuration Mode	
ipv6 enable	To enable the IPv6 function on the switch.

2. Configure IPv6 Black Hole Routing

Command	Explanation
Global Configuration Mode	
ipv6 route <ipv6-prefix/prefix-length> null0 [<precedence>] no ipv6 route <ipv6-prefix/prefix-length> null0	To configure static IPv6 Black Hole Routing. The no form of this command will remove the specified configuration.

41.4 Black Hole Routing Configuration Examples

Example 1: IPv4 Black Hole Routing function.

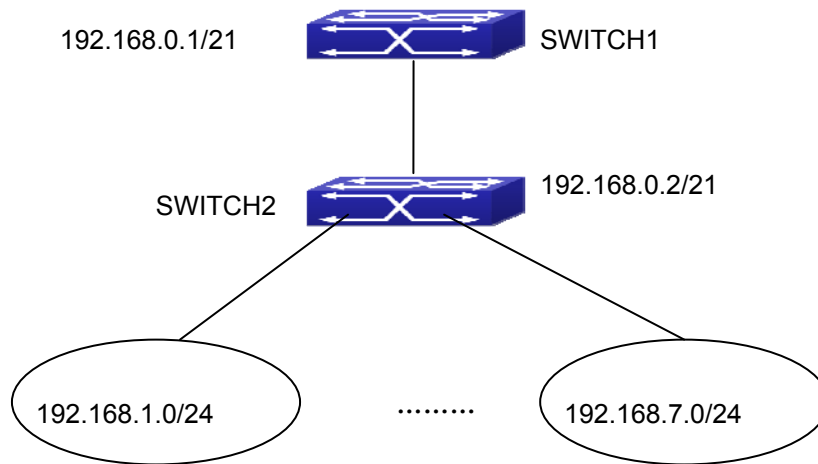

Figure 41-4-1 IPv4 Black Hole Routing Configuration Example

As it is shown in the figure, in Switch 2, eight in all interfaces are configured as Layer 3 VLAN interfaces for access interfaces. The network addresses are 192.168.1.0/24 ~ 192.268.7.0/24. A default routing is configured on Switch 2 to connect to Switch 1. And a backward default routing is configured on Switch 1 to Switch 2, whose network address is 192.168.0.0/21. Commonly, this configuration will work well. However, if one of the Layer 3 interfaces in Switch 2 goes down, for example, the interface belonged to 192.168.1.0/24. When datagrams arrives at VLAN1 in Switch 2, there will be no routing rules for these datagrams. The switch then will forward these datagrams according to the default routing, back to Switch 1. When Switch 1 receives these datagrams, it will forward them back to Switch 2. Thus, loopback exists. To solve this problem, Black Hole Routing can be introduced on Switch 2.

```
ip route 192.168.0.0/21 null0 50
```

Then Switch 2 will drop the datagrams from interface VLAN1 that match the Black Hole Routing rule. And loopback routing is prevented.

Configuration steps are listed below:

```
XGS3-42000R#config
XGS3-42000R(config)#ip route 192.168.0.0/21 null0 50
```

Example 2: IPv6 Black Hole Routing function.

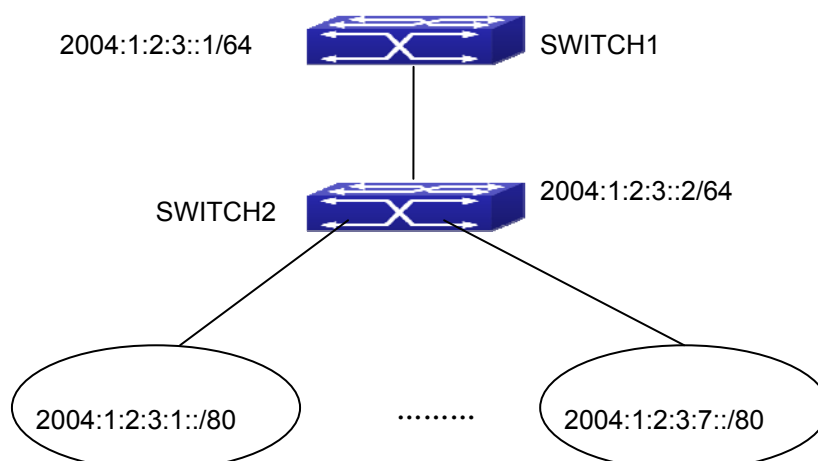

Figure 41-4-2 IPv6 Black Hole Routing Configuration Example

As it is shown in the figure, in Switch 2, eight in all interfaces are configured as Layer 3 VLAN interfaces for access interfaces. The network addresses are 2004:1:2:3:1/80~2004:1:2:3:7/80. A default routing is configured on Switch 2 to connect to Switch 1. And a backward default routing is configured on Switch 1 to Switch 2, whose network address is 2004:1:2:3::/64. Commonly, this configuration will work well. However, if one of the Layer 3 interfaces in Switch 2 goes down, for example, the interface belonged to 2004:1:2:3:1/80. When datagrams arrives at VLAN1 in Switch 2, there will be no routing rules for these datagrams. The switch then will forward these datagrams according to the default routing, back to Switch 1. When Switch 1 receives these datagrams, it will forward them back to Switch 2. Thus, loopback exists. To solve this problem, Black Hole Routing can be introduced on Switch 2.

```
ipv6 route 2004:1:2:3::/64 null0 50
```

Then Switch 2 will drop the datagrams from interface VLAN1 that match the Black Hole Routing rule. And loopback routing is prevented.

Configuration steps are listed below:

```
XGS3-42000R#config
XGS3-42000R(config)#ipv6 route 2004:1:2:3::/64 null0 50
```

41.5 Black Hole Routing Troubleshooting

When configuring the Black Hole Routing function, the configuration may not work due to some reasons such as incorrect network address mask, and incorrect management distance. Attention should be paid to the following items:

- IPv6 should be enabled before IPv6 Black Hole Routing can work.
- It is suggested that the length of the network address mask should be longer than that of normal routing configuration, in order to prevent the Black Hole Routing from intervening other routing configuration.
- When the network address mask of Black Hole Routing configuration is the same as some other configurations, it is suggested that the distance of Black Hole Routing is set lower.

For problems that cannot be fixed through above methods, please issue the command show ip route distance and show ip route fib, and show I3. And copy and paste the output of the commands, and send to the technical service center of our company.

Chapter 42 ECMP Configuration

42.1 Introduction to ECMP

ECMP (Equal-cost Multi-path Routing) works in the network environment where there are many different links to arrive at the same destination address. If using the traditional routing technique, only a link can be used to send the data packets to the destination address, other links at the backup state or the invalidation state, and it needs some times to process the mutual switchover under the static routing environment. However, ECMP protocol can use multi-links under such network environment, it not only implements the load balance, increases the transport bandwidth, but also can completely backup the data transport of the invalidation links without delay and packet loss.

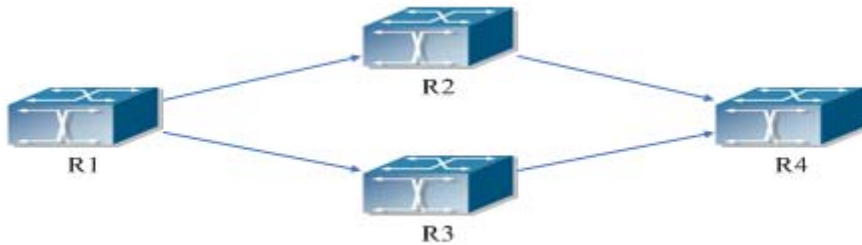

Figure 42-1-1 the application environment of ECMP

As it is shown in the figure, there are two paths can be selected from R1 to R4, they are R1-R2-R4 and R1-R3-R4. If the route type and the cost are same, then it can forms two routes from R1 to R4, but the next hop is different. If two routes are selected as the best, then they form the equal-cost route.

42.2 ECMP Configuration Task List

1. Configure the max. number of equal-cost route

Command	Explanation
Global mode	
maximum-paths <1-32> no maximum-paths	Configure the max number of equal-cost route.

42.3 ECMP Typical Example

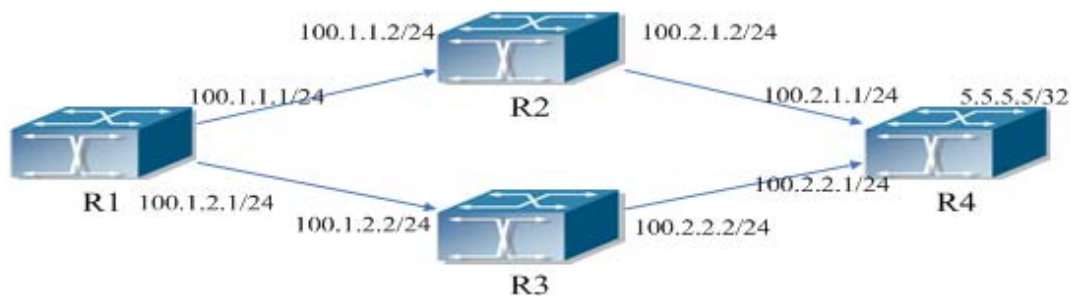

Figure 42-3-1 the application environment of ECMP

As it is shown in the figure, the R1 connect to R2 and R3 with the interface address 100.1.1.1/24 and 100.1.2.1/24. The R2 and R3 connect to R1 with the interface address 100.1.1.2/24 and 100.1.2.2/24. The R4 connect to R2 and R3 with interface address 100.2.1.1/24 and 100.2.2.1/24. The R2 and R3 connect to R4 with the interface address 100.2.1.2/24, 100.2.2.2/24. The loopback address of R4 is 5.5.5.5/32.

42.3.1 Static Route Implements ECMP

```
R1(config)#ip route 5.5.5.5/32 100.1.1.2
R1(config)#ip route 5.5.5.5/32 100.1.2.2
```

On R1, show ip route, the following is displayed:

```
R1(config)#show ip route
```

Codes: K - kernel, C - connected, S - static, R - RIP, B - BGP

O - OSPF, IA - OSPF inter area

N1 - OSPF NSSA external type 1, N2 - OSPF NSSA external type 2

E1 - OSPF external type 1, E2 - OSPF external type 2

i - IS-IS, L1 - IS-IS level-1, L2 - IS-IS level-2, ia - IS-IS inter area

* - candidate default

```
C    1.1.1.1/32 is directly connected, Loopback1 tag:0
```

```
S    5.5.5.5/32 [1/0] via 100.1.1.2, Vlan100 tag:0
      [1/0] via 100.1.2.2, Vlan200 tag:0
```

```
C    100.1.1.0/24 is directly connected, Vlan100 tag:0
```

```
C    100.1.2.0/24 is directly connected, Vlan200 tag:0
```

```
C    127.0.0.0/8 is directly connected, Loopback tag:0
```

```
Total routes are : 6 item(s)
```

42.3.2 OSPF Implements ECMP

R1 configuration:

```
R1(config)#interface Vlan100
R1(Config-if-Vlan100)# ip address 100.1.1.1 255.255.255.0
R1(config)#interface Vlan200
R1(Config-if-Vlan200)# ip address 100.1.2.1 255.255.255.0
R1(config)#interface loopback 1
R1(Config-if-loopback1)# ip address 1.1.1.1 255.255.255.255
R1(config)#router ospf 1
R1(config-router)# ospf router-id 1.1.1.1
R1(config-router)# network 100.1.1.0/24 area 0
R1(config-router)# network 100.1.2.0/24 area 0
```

R2 configuration:

```
R2(config)#interface Vlan100
R2(Config-if-Vlan100)# ip address 100.1.1.2 255.255.255.0
R2(config)#interface Vlan200
R2(Config-if-Vlan200)# ip address 100.2.1.2 255.255.255.0
R2(config)#interface loopback 1
R2(Config-if-loopback1)# ip address 2.2.2.2 255.255.255.255
R2(config)#router ospf 1
R2(config-router)# ospf router-id 2.2.2.2
R2(config-router)# network 100.1.1.0/24 area 0
R2(config-router)# network 100.2.1.0/24 area 0
```

R3 configuration:

```
R3(config)#interface Vlan100
R3(Config-if-Vlan100)# ip address 100.1.2.2 255.255.255.0
R3(config)#interface Vlan200
R3(Config-if-Vlan200)# ip address 100.2.2.2 255.255.255.0
R3(config)#interface loopback 1
R3(Config-if-loopback1)# ip address 3.3.3.3 255.255.255.255
R3(config)#router ospf 1
R3(config-router)# ospf router-id 3.3.3.3
R3(config-router)# network 100.1.2.0/24 area 0
R3(config-router)# network 100.2.2.0/24 area 0
```

R4 configuration:

```
R4(config)#interface Vlan100
R4(Config-if-Vlan100)# ip address 100.2.1.1 255.255.255.0
R4(config)#interface Vlan200
```

```
R4(Config-if-Vlan200)# ip address 100.2.2.1 255.255.255.0
R4(config)#interface loopback 1
R4(Config-if-loopback1)# ip address 5.5.5.5 255.255.255.255
R4(config)#router ospf 1
R4(config-router)# ospf router-id 4.4.4.4
R4(config-router)# network 100.2.1.0/24 area 0
R4(config-router)# network 100.2.2.0/24 area 0
```

On R1, show ip route, the following is displayed:

```
R1(config)#show ip route
```

Codes: K - kernel, C - connected, S - static, R - RIP, B - BGP

O - OSPF, IA - OSPF inter area

N1 - OSPF NSSA external type 1, N2 - OSPF NSSA external type 2

E1 - OSPF external type 1, E2 - OSPF external type 2

i - IS-IS, L1 - IS-IS level-1, L2 - IS-IS level-2, ia - IS-IS inter area

* - candidate default

```
C    1.1.1.1/32 is directly connected, Loopback1 tag:0
O    5.5.5.5/32 [110/3] via 100.1.1.2, Vlan100, 00:00:05 tag:0
      [110/3] via 100.1.2.2, Vlan200, 00:00:05 tag:0
C    100.1.1.0/24 is directly connected, Vlan100 tag:0
C    100.1.2.0/24 is directly connected, Vlan200 tag:0
O    100.2.1.0/24 [110/2] via 100.1.1.2, Vlan100, 00:02:25 tag:0
O    100.2.2.0/24 [110/2] via 100.1.2.2, Vlan200, 00:02:25 tag:0
C    127.0.0.0/8 is directly connected, Loopback tag:0
```

Total routes are: 8 item(s)

Chapter 43 IPv4 Multicast Protocol

43.1 IPv4 Multicast Protocol Overview

This chapter will give an introduction to the configuration of IPv4 Multicast Protocol. All IPs in this chapter are IPv4.

43.1.1 Introduction to Multicast

Various transmission modes can be adopted when the destination of packet (including data, sound and video) transmission is the minority users in the network. One way is to use Unicast mode, i.e. to set up a separate data transmission path for each user; or, to use Broadcast mode, which is to send messages to all users in the network, and they will receive the Broadcast messages no matter they need or not. For example, if there are 200 users in a network who want to receive the same packet, then the traditional solution is to send this packet for 200 times separately via Unicast to guarantee the users who need the data can get all data wanted, or send the data in the entire domain via Broadcast. Transferring the data in the whole range of network. The users who need these data can get directly from the network. Both modes waste a great deal of valuable bandwidth resource, and furthermore, Broadcast mode goes against the security and secrecy.

The emergence of IP Multicast technology solved this problem in time. The Multicast source only sends out the message once, Multicast Routing Protocol sets up tree-routing for Multicast data packet, and then the transferred packet just starts to be duplicated and distributed in the bifurcate crossing as far as possible. Thus the packet can be sent to every user who needs it accurately and effectively.

It should be noticed that it is not necessary for Multicast source to join in Multicast group. It sends data to some Multicast groups, but it is not necessarily a receiver of the group itself. There can be more than one source sending packets to a Multicast group simultaneously. There may exist routers in the network which do not support Multicast, but a Multicast router can encapsulate the Multicast packets into Unicast IP packets with tunnel mode to send them to the Multicast router next to it, which will take off the Unicast IP header and continue the Multicast transmission process, thus a big alteration of network structure is avoided. The primary advantages of Multicast are:

1. Enhance efficiency: reduce network traffic, lighten the load of server and CPU
2. Optimize performance: reduce redundant traffic
3. Distributed application: Enable Multipoint Application

43.1.2 Multicast Address

The destination address of Multicast message uses class D IP address with range from 224.0.0.0 to 239.255.255.255. D class address can not appear in the source IP address field of an IP message. In the process of Unicast data transmission, the transmission path of a data packet is from source address routing to

destination address, and the transmission is performed with hop-by-hop principle. However, in IP Multicast environment, the destination addresses is a group instead of a single one, they form a group address. All message receivers will join in a group, and once they do, the data flowing to the group address will be sent to the receivers immediately and all members in the group will receive the data packets. The members in a Multicast group are dynamic, the hosts can join and leave the Multicast group at any time.

Multicast group can be permanent or temporary. Some of the Multicast group addresses are assigned officially; they are called Permanent Multicast Group. Permanent Multicast Group keeps its IP address fixed but its member structure can vary within. The member amount of Permanent Multicast Group can be arbitrary, even zero. The IP Multicast addresses which are not kept for use by Permanent Multicast Group can be utilized by temporary Multicast groups.

224.0.0.0~224.0.0.255 are reserved Multicast addresses (Permanent Group Address), address 224.0.0.0 is reserved but not assigned, and other addresses are used by Routing Protocol; 224.0.1.0~238.255.255.255 are Multicast addresses available to users (Temporary Group Address) and are valid in the entire domain of the network; 239.0.0.0~239.255.255.255 are local management Multicast addresses, which are valid only in specific local domain. Frequently used reserved multicast address list is as follows:

- Benchmark address (reserved)
- 224.0.0.1 Address of all hosts
- 224.0.0.2 Address of all Multicast Routers
- 224.0.0.3 Unassigned
- 224.0.0.4 DVMRP Router
- 224.0.0.5 OSPF Router
- 224.0.0.6 OSPF DR
- 224.0.0.7 ST Router
- 224.0.0.8 ST host
- 224.0.0.9 RIP-2 Router
- 224.0.0.10 IGRP Router
- 224.0.0.11 Active Agent
- 224.0.0.12 DHCP Server/Relay Agent
- 224.0.0.13 All PIM Routers
- 224.0.0.14 RSVP Encapsulation
- 224.0.0.15 All CBT Routers
- 224.0.0.16 Specified SBM
- 224.0.0.17 All SBMS
- 224.0.0.18 VRRP
- 224.0.0.22 IGMP

When Ethernet transmits Unicast IP messages, the destination MAC address it uses is the receiver's MAC address. But in transmitting Multicast packets, the transmission destination is not a specific receiver any more, but a group with uncertain members, thus Multicast MAC address is used. Multicast MAC address is corresponding to Multicast IP address. It is prescribed in IANA (Internet Assigned Number Authority) that the higher 25 bits in Multicast MAC address is 0x01005e, and the lower 23bits in MAC address is the lower 23bits in Multicast IP address.

Since only 23bits out of the lower 28bits in IP Multicast address are mapped into MAC address, therefore there are 32 IP Multicast addresses which are mapped into the same MAC address.

43.1.3 IP Multicast Packet Transmission

In Multicast mode, the source host sends packets to the host group indicated by the Multicast group address in the destination address field of IP data packet. Unlike Unicast mode, Multicast data packet must be forwarded to a number of external interfaces to be sent to all receiver sites in Multicast mode, thus Multicast transmission procedure is more complicated than Unicast transmission procedure.

In order to guarantee that all Multicast packets get to the router via the shortest path, the receipt interface of the Multicast packet must be checked in some certain way based on Unicast router table; this checking mechanism is the basis for most Multicast Routing Protocol to forward in Multicast mode -- RPF (Reverse Path Forwarding) check. Multicast router makes use of the impressed packet source address to query Unicast Router Table or independent Multicast Router Table to determine if the packet ingress interface is on the shortest path from receipt site to source address. If shortest path Tree is used, then the source address is the address of source host which sends Multicast Data Packets; if Shared Tree is used, then the source address is the address of the root of the Shared-Tree. When Multicast data packet gets to the router, if RPF check passes, then the data packet is forwarded according to Multicast forward item, and the data packet will be discarded else wise.

43.1.4 IP Multicast Application

IP Multicast technology has effectively solved the problem of sending in single point and receiving in multipoint. It has achieved the effective data transmission from a point to multiple points, saved a great deal of network bandwidth and reduced network load. Making use of the Multicast property of network, some new value-added operations can be supplied conveniently. In Information Service areas such as online living broadcast, network TV, remote education, remote medicine, real time video/audio meeting, the following applications may be supplied:

- 1) Application of Multimedia and Streaming Media
- 2) Data repository, finance application (stock) etc
- 3) Any data distribution application of "one point to multiple points"

In the situation of more and more multimedia operations in IP network, Multicast has tremendous market potential and Multicast operation will be generalized and popularized.

43.2 PIM-DM

43.2.1 Introduction to PIM-DM

PIM-DM (Protocol Independent Multicast, Dense Mode) is a Multicast Routing Protocol in dense mode which applies to small network. The members of multicast group are relatively dense under this kind of network environment.

The working process of PIM-DM can be summarized as: Neighbor Discovery, Flooding & Prune, and Graft.

1. Neighbor Discovery

After PIM-DM router is enabled, Hello message is required to discover neighbors. The network nodes which run PIM-DM use Hello message to contact each other. PIM-DM Hello message is sent periodically.

2. Flooding & Prune of process

PIM-DM assumes all hosts on the network are ready to receive Multicast data. When some Multicast Source begins to send data to a Multicast Group G, after receiving the Multicast packet, the router will make RPF check first according to the Unicast table. If the check passes, the router will create a (S, G) table entry and transmit the Multicast packet to all downstream PIM-DM nodes on the network (Flooding). If the RPF check fails, i.e. the Multicast packet is input from the incorrect interface, and then the message is discarded. After this procedure, in the PIM-DM Multicast domain, every node will create a (S, G) table entry. If there is no Multicast group member in the downstream nodes, then a Prune message is sent to upstream nodes to notify them not to transmit data of this Multicast group any more. After receiving Prune message, the upstream nodes will delete the corresponding interface from the output interface list to which their Multicast transmission table entry (S, G) corresponds. Thus a SPT (Shortest Path Tree, SPT) tree with source S as root is created. The Prune process is initiated by leaf router first.

The process above is called Flooding & Prune process. Each pruned node also provides time-out mechanics at the same time. When Prune is timed-out, the router will restart Flooding & Prune process. The PIM-DM Flooding & Prune is periodically processed.

3. RPF Check

With RPF Check, PIM-DM makes use of existing Unicast routing table to establish a Multicast transmission tree initiating from data source. When a Multicast packet arrives, the router will determine whether the coming path is correct first. If the arrival interface is the interface connected to Multicast source indicated by Unicast routing, then this Multicast packet is considered to be from the correct path. Otherwise the Multicast packet is to be discarded as redundant message. The Unicast routing message used as path judgment can root in any Unicast Routing Protocol, such as messages found by RIP, OSPF, etc. It doesn't rely on any specific Unicast Routing Protocol.

4. Assert Mechanism

If each of two Multicast routers A and B on the same LAN segment has a receiving route respectively and both will transmit the Multicast packet to the LAN after receiving the Multicast data packet sent by the Multicast Source S, then the downstream node Multicast router C will receive two exactly same Multicast

packets. The router needs to choose a unique transmitter through Assert mechanism after it detects this situation. An optimal transmission path is selected through sending out Assert packet. If the priority and cost of two or more path are same, then the node with larger IP address is taken as the upstream neighbor of the (S, G) entry and in charge of the transmission of the (S, G) Multicast packet.

5. Graft

When the pruned downstream node needs to recover to transmission status, this node uses Graft Packet to notify upstream nodes to restore multicast data transmission.

43.2.2 PIM-DM Configuration Task List

1. Enable PIM-DM (Required)
2. Configure static multicast routing entries(Optional)
3. Configure additional PIM-DM parameters(Optional)
 - a) Configure the interval for PIM-DM hello messages
 - b) Configure the interval for state-refresh messages
 - c) Configure the boundary interfaces
 - d) Configure the management boundary
4. Disable PIM-DM protocol

1. Enable the PIM-DM protocol

When configuring the PIM-DM protocol on XGS3 series Layer 3 switches, PIM multicasting should be enabled globally, then PIM-DM can be enabled for specific interfaces.

Command	Explanation
Global Mode	
ip pim multicast-routing no ip pim multicast-routing	To enable PIM-DM globally for all the interfaces (However, in order to make PIM-DM work for specific interfaces, the following command should be issued).

And then turn on PIM-SM switch on the interface

Command	Explanation
Interface Configuration Mode	
ip pim dense-mode	To enable PIM-DM protocol for the specified interface.(Required)

2. Configure static multicast routing entries

Command	Explanation
Global Configuration Mode	
ip mroute <A.B.C.D> <A.B.C.D> <ifname> <.ifname> no ip mroute <A.B.C.D> <A.B.C.D> [<ifname> <.ifname>]	To configure a static multicast routing entry. The no form of this command will remove the specified entry.

3. Configure additional PIM-DM parameters

- a) Configure the interval for PIM-DM hello messages

Command	Explanation
Interface Configuration Mode	
ip pim hello-interval < interval> no ip pim hello-interval	To configure the interval for PIM-DM hello messages. The no form of this command will restore the interval to the default value.

- b) Configure the interval for state-refresh messages

Command	Explanation
Interface Configuration Mode	
ip pim state-refresh origination-interval no ip pim state-refresh origination-interval	To configure the interval for sending PIM-DM state-refresh packets. The no form of this command will restore the default value.

- c) Configure the boundary interfaces

Command	Explanation
Interface Configuration Mode	
ip pim bsr-border no ip pim bsr-border	To configure the interface as the boundary of PIM-DM protocol. On the boundary interface, BSR messages will not be sent or received. The network connected the interface is considered as directly connected network. The no form of this command will remove the configuration.

- d) Configure the management boundary

Command	Explanation
Interface Configuration Mode	
ip pim scope-border < 1-99 > <acl_name> no ip pim scope-border	To configure PIM-DM management boundary for the interface and apply ACL for the management boundary. With default settings, 239.0.0.0/8 is considered as the scope of the management group. If ACL is configured, then the scope specified by ACL permit command is the scope of the management group. The no form of this command will remove the configuration.

4. Disable PIM-DM protocol

Command	Explanation
Interface Configuration Mode	
no ip pim dense-mode	To disable the PIM-DM protocol for the interface.

Global Configuration Mode	
no ip pim multicast-routing	To disable PIM-DM globally.

43.2.3 PIM-DM Configuration Examples

As shown in the following figure, add the Ethernet interfaces of Switch A and Switch B to corresponding vlan, and enable PIM-DM Protocol on each vlan interface.

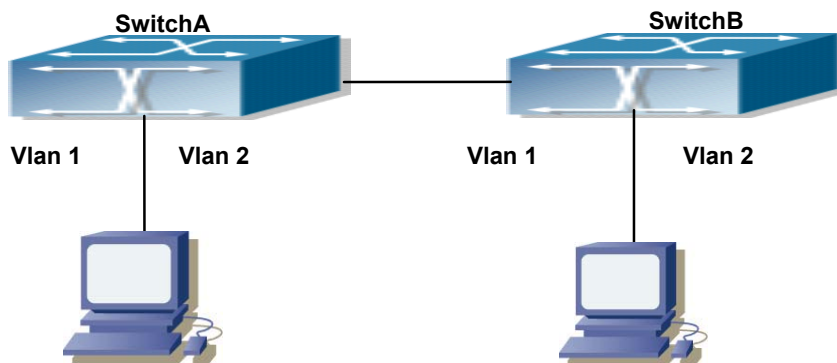

Figure 43-2-1 PIM-DM Typical Environment

The configuration procedure for SwitchA and SwitchB is as follows:

(1) Configure SwitchA:

```
XGS3-42000R(config)#ip pim multicast-routing
XGS3-42000R(config)#interface vlan 1
XGS3-42000R(config-if-Vlan1)# ip address 10.1.1.1 255.255.255.0
XGS3-42000R(config-if-Vlan1)# ip pim dense-mode
XGS3-42000R(config-if-Vlan1)#exit
XGS3-42000R(config)#interface vlan2
XGS3-42000R(config-if-Vlan2)# ip address 12.1.1.1 255.255.255.0
XGS3-42000R(config-if-Vlan2)# ip pim dense-mode
```

(2) Configure SwitchB:

```
XGS3-42000R(config)#ip pim multicast-routing
XGS3-42000R(config)#interface vlan 1
XGS3-42000R(config-if-Vlan1)# ip address 12.1.1.2 255.255.255.0
XGS3-42000R(config-if-Vlan1)# ip pim dense-mode
XGS3-42000R(config-if-Vlan1)#exit
XGS3-42000R(config)#interface vlan 2
XGS3-42000R(config-if-Vlan2)# ip address 20.1.1.1 255.255.255.0
XGS3-42000R(config-if-Vlan2)# ip pim dense-mode
```

At the same time, you should pay attention to the configuration of Unicast Routing Protocol, assure that each device can communicate with each other in the network layer, and be able to implement dynamic routing update in virtue of Unicast Routing Protocol.

43.2.4 PIM-DM Troubleshooting

In configuring and using PIM-DM Protocol, PIM-DM Protocol might not operate normally caused by physical connection or incorrect configuration. Therefore, the user should pay attention to the following issues:

- To assure that physical connection is correct
- To assure the Protocol of Interface and Link is UP (use show interface command)
- To assure PIM Protocol is enabled in Global Mode (use ipv6 pim multicast-routing)
- Enable PIM-DM Protocol on the interface (use ipv6 pim dense-mode command)
- Multicast Protocol requires RPF Check using Unicast routing; therefore the correctness of Unicast routing must be assured beforehand

If all attempts including Check are made but the problems on PIM-DM can't be solved yet, then use debug commands such as debug pim please, and then copy DEBUG information in 3 minutes and send to Technology Service Center.

43.3 PIM-SM

43.3.1 Introduction to PIM-SM

PIM-SM (Protocol Independent Multicast, Sparse Mode) is Protocol Independent Multicast Sparse Mode. It is a Multicast Routing Protocol in Sparse Mode and mainly used in big scale network with group members distributed relatively sparse and wide-spread. Unlike the Flooding & Prune of Dense Mode, PIM-SM Protocol assumes no host needs receiving Multicast data packets. PIM-SM router transmits Multicast Data Packets to a host only if it presents explicit requirement.

By setting RP (Rendezvous Point) and BSR (Bootstrap Router), PIM-SM announce Multicast packet to all PIM-SM routers and establish RPT (RP-rooted shared tree) based on RP using Join/Prune message of routers. Consequently the network bandwidth occupied by data packets and message control is cut down and the transaction cost of routers decreases. Multicast data get to the network segment where the Multicast group members are located along the shared tree flow. When the data traffic reaches a certain amount, Multicast data stream can be switched to the shortest path tree SPT based on the source to reduce network delay. PIM-SM doesn't rely on any specific Unicast Routing Protocol but make RPF Check using existing Unicast routing table.

1. PIM-SM Working Principle

The central working processes of PIM-SM are: Neighbor Discovery, Generation of RP Shared Tree (RPT), Multicast source registration, SPT Switch, etc. We won't describe the mechanism of Neighbor Discovery here since it is same as that of PIM-DM.

(1) Generation of RP Shared Tree (RPT)

When a host joins a Multicast Group G, the leaf router that is connected to this host directly finds out through IGMP message that there is a receiver of Multicast Group G, then it works out the corresponding Rendezvous Point RP for Multicast Group G, and send join message to upper level nodes in RP direction. Every router on the way from the leaf router to RP will generate a (*, G) table entry, where a message from any source to Multicast group applies to this entry. When RP receives the message sent to Multicast Group G, the message will get to the leaf router along the set up path and reach the host. In this way the RPT with RP as root is generated.

(2) Multicast Source Registration

When a Multicast Source S sends a Multicast packet to Multicast Group G, the PIM-SM Multicast router connected to it directly will take charge of encapsulating the Multicast packet into registered message and unicast it to corresponding RP. If there are more than one PIM-SM Multicast routers on a network segment, then DR (Designated Router) takes charge of sending the Multicast packet.

(3) SPT Switch

When the Multicast router finds that the rate of the Multicast packet from RP with destination address G exceeds threshold, the Multicast router will send Join message to the next upper level nodes in the source direction, which results in the switch from RPT to SPT.

2. Preparation before PIM-SM configuration

(1) Configuration Candidate RP

More than one RPs (candidate RP) can exist in PIM-SM network and each C-RP (Candidate RP) takes charge of transmitting Multicast packets with destination address in a certain range. To configure more than one candidate RPs can implement RP load share. No master or slave is differentiated among RPs. All Multicast routers work out the RP corresponding to some Multicast group based on the same algorithm after receiving the candidate RP message announced by BSR. Note that one RP can serve more than one Multicast groups and all Multicast groups. Each Multicast group can only correspond to one unique RP at any moment. It can't correspond to more than one RP at the same time.

(2) Configure BSR

BSR is the management center of PIMSM network. It is in charge of collecting messages sent by candidate RPs and broadcast them.

Only one BSR can exist within a network, but more than one C-BSR (Candidate-BSR) can be configured. In this way, if some BSR goes wrong, it can switch to another. C-BSRs elect BSR automatically.

43.3.2 PIM-SM Configuration Task List

1. Enable PIM-SM (Required)
2. Configure static multicast routing entries (Optional)
3. Configure additional parameters for PIM-SM (Optional)
 - (1) Configure parameters for PIM-SM interfaces
 - 1) Configure the interval for PIM-SM hello messages
 - 2) Configure the hold time for PIM-SM hello messages

- 3) Configure ACL for PIM-SM neighbors
- 4) Configure the interface as the boundary interface of the PIM-SM protocol
- 5) Configure the interface as the management boundary of the PIM-SM protocol
- (2) Configure global PIM-SM parameters
 - 1)Configure the switch as a candidate BSR
 - 2)Configure the switch as a candidate RP
 - 3)Configure static RP
4. Disable PIM-SM Protocol

1. Enable PIM-SM Protocol

The PIM-SM protocol can be enabled on XGS3 series Layer 3 switches by enabling PIM in global configuration mode and then enabling PIM-SM for specific interfaces in the interface configuration mode.

Command	Explanation
Global Mode	
ip pim multicast-routing	To enable the PIM-SM protocol for all the interfaces (However, in order to make PIM-SM work for specific interfaces, the following command should be issued).(Required)

And then turn on PIM-SM switch on the interface

Command	Explanation
Interface Configuration Mode	
ip pim sparse-mode	Enable PIM-SM Protocol of the interface. (Required).

2. Configure static multicast routing entries

Command	Explanation
Global Configuration Mode	
ip mroute <A.B.C.D> <A.B.C.D> <ifname> <.ifname> no ip mroute <A.B.C.D> <A.B.C.D> [<.ifname> <.ifname>]	To configure a static multicast routing entry. The no form of this command will remove the specified static multicast routing entry.

3. Configure additional parameters for PIM-SM

(1) Configure parameters for PIM-SM interfaces

- 1)Configure the interval for PIM-SM hello messages

Command	Explanation
Interface Configuration Mode	
ip pim hello-interval <interval> no ip pim hello-interval	To configure the interval for PIM-SM hello messages. The no form of this command restores the interval to the default value.

2) Configure the hold time for PIM-SM hello messages

Command	Explanation
Interface Configuration Mode	
ip pim hello-holdtime <value> no ip pim hello-holdtime	To configure the value of the holdtime field in the PIM-SM hello messages. The no form of this command will restore the hold time to the default value.

3) Configure ACL for PIM-SM neighbors

Command	Explanation
Interface Configuration Mode	
ip pim neighbor-filter{<access-list-number > } no ip pim neighbor-filter{<access-list-number > }	To configure ACL to filter PIM-SM neighbors. If session to the neighbor has been denied by ACL, then the sessions that have been set up will be discarded immediately and new sessions will not be set up.

4) Configure the interface as the boundary interface of the PIM-SM protocol

Command	Explanation
Interface Configuration Mode	
ip pim bsr-border no ip pim bsr-border	To configure the interface as the boundary of PIM-SM protocol. On the boundary interface, BSR messages will not be sent or received. The network connected the interface is considered as directly connected network. The no form of this command will remove the configuration.

5) Configure the interface as the management boundary of the PIM-SM protocol

Command	Explanation
Interface Configuration Mode	
ip pim scope-border <1-99> <acl_name> no ip pim scope-border	To configure PIM-SM management boundary for the interface and apply ACL for the management boundary. With default settings, 239.0.0.0/8 is considered as the scope of the management group. If ACL is configured, then the scope specified by ACL permit command is the scope of the management group. acl_name should be standard IPv4 ACL name. The no form of this command will remove the configuration.

(2) Configure global PIM-SM parameter

- 1) Configure the switch as a candidate BSR

Command	Explanation
Global Configuration Mode	
ip pim bsr-candidate {vlan <vlan-id> <ifname>}[<mask-length>][<priority>] no ip pim bsr-candidate	This command is the global candidate BSR configuration command, which is used to configure the information of PIM-SM candidate BSR so that it can compete for BSR router with other candidate BSR. The “ no ip pim bsr-candidate ” command cancels the configuration of BSR.

- 2) Configure the switch as a candidate RP

Command	Explanation
Global Configuration Mode	
ip pim rp-candidate { vlan <vlan-id> lookback<index> <ifname> } [<A.B.C.D>][<priority>] no ip pim rp-candidate	This command is the global candidate RP configuration command, which is used to configure the information of PIM-SM candidate RP so that it can compete for RP router with other candidate RP. The “ no ip pim rp-candidate ” command cancels the configuration of RP.

- 3) Configure static RP

Command	Explanation
Global Configuration Mode	
ip pim rp-address <A.B.C.D> [<A.B.C.D/M>] no ip pim rp-address <A.B.C.D> {<all> <A.B.C.D/M>}	The command is the multicast group configuration static RP of the globally or multicast address range. The no form of this command will remove the configuration for the static RP.

4. Disable PIM-SM Protocol

Command	Explanation
Interface Configuration Mode	
no ip pim sparse-mode no ip pim multicast-routing(Global configuration mode)	To disable the PIM-SM protocol.

43.3.3 PIM-SM Configuration Examples

As shown in the following figure, add the Ethernet interfaces of SwitchA, SwitchB, SwitchC and SwitchD to the corresponding VLAN, and enable PIM-SM Protocol on each VLAN interface.

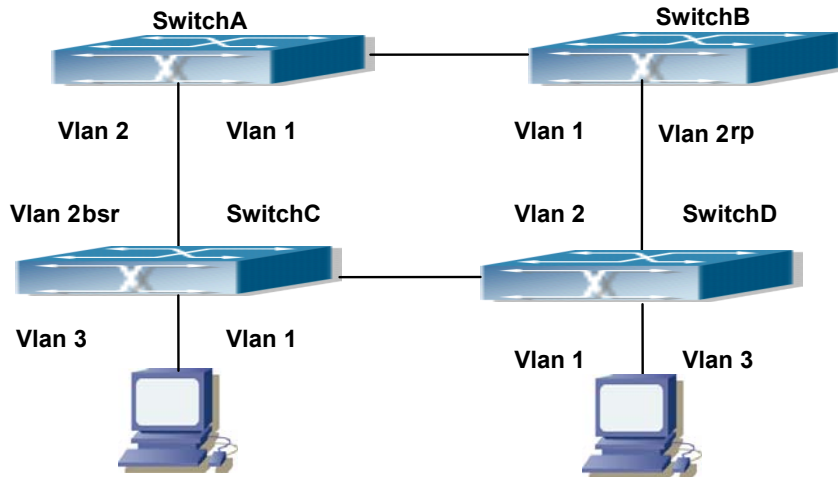

Figure 43-3-1 PIM-SM Typical Environment

The configuration procedure for SwitchA, SwitchB, SwitchC and SwitchD is as follows:

(1) Configure SwitchA:

```
XGS3-42000R(config)#ip pim multicast-routing
XGS3-42000R(config)#interface vlan 1
XGS3-42000R(config-if-Vlan1)# ip address 12.1.1.1 255.255.255.0
XGS3-42000R(config-if-Vlan1)# ip pim sparse-mode
XGS3-42000R(config-if-Vlan1)#exit
XGS3-42000R(config)#interface vlan 2
XGS3-42000R(config-if-Vlan2)# ip address 13.1.1.1 255.255.255.0
XGS3-42000R(config-if-Vlan2)# ip pim sparse-mode
```

(2) Configure SwitchB:

```
XGS3-42000R(config)#ip pim multicast-routing
XGS3-42000R(config)#interface vlan 1
XGS3-42000R(config-if-Vlan1)# ip address 12.1.1.2 255.255.255.0
XGS3-42000R(config-if-Vlan1)# ip pim sparse-mode
XGS3-42000R(config-if-Vlan1)#exit
XGS3-42000R(config)#interface vlan 2
XGS3-42000R(config-if-Vlan2)# ip address 24.1.1.2 255.255.255.0
XGS3-42000R(config-if-Vlan2)# ip pim sparse-mode
XGS3-42000R(config-if-Vlan2)# exit
XGS3-42000R(config)# ip pim rp-candidate vlan2
```

(3) Configure SwitchC:

```
XGS3-42000R(config)#ip pim multicast-routing
XGS3-42000R(config)#interface vlan 1
XGS3-42000R(config-if-Vlan1)# ip address 34.1.1.3 255.255.255.0
XGS3-42000R(config-if-Vlan1)# ip pim sparse-mode
XGS3-42000R(config-if-Vlan1)#exit
XGS3-42000R(config)#interface vlan 2
XGS3-42000R(config-if-Vlan2)# ip address 13.1.1.3 255.255.255.0
XGS3-42000R(config-if-Vlan2)# ip pim sparse-mode
XGS3-42000R(config-if-Vlan2)#exit
XGS3-42000R(config)#interface vlan 3
XGS3-42000R(config-if-Vlan3)# ip address 30.1.1.1 255.255.255.0
XGS3-42000R(config-if-Vlan3)# ip pim sparse-mode
XGS3-42000R(config-if-Vlan3)# exit
XGS3-42000R(config)# ip pim bsr-candidate vlan2 30 10
```

(4) Configure SwitchD:

```
XGS3-42000R(config)#ip pim multicast-routing
XGS3-42000R(config)#interface vlan 1
XGS3-42000R(config-if-Vlan1)# ip address 34.1.1.4 255.255.255.0
XGS3-42000R(config-if-Vlan1)# ip pim sparse-mode
XGS3-42000R(config-if-Vlan1)#exit
XGS3-42000R(config)#interface vlan 2
XGS3-42000R(config-if-Vlan2)# ip address 24.1.1.4 255.255.255.0
XGS3-42000R(config-if-Vlan2)# ip pim sparse-mode
XGS3-42000R(config-if-Vlan2)#exit
XGS3-42000R(config)#interface vlan 3
XGS3-42000R(config-if-Vlan3)# ip address 40.1.1.1 255.255.255.0
XGS3-42000R(config-if-Vlan3)# ip pim sparse-mode
```

At the same time, you should pay attention to the configuration of Unicast Routing Protocol, assure that each device can communicate with each other in the network layer, and be able to implement dynamic routing update in virtue of Unicast Routing Protocol.

43.3.4 PIM-SM Troubleshooting

In configuring and using PIM-SM Protocol, PIM-SM Protocol might not operate normally caused by physical connection or incorrect configuration. Therefore, the user should pay attention to the following issues:

- Assure that physical connection is correct;
- Assure the Protocol of Interface and Link is UP (use show interface command);
- Assure that PIM Protocol is enabled in Global Mode (use ip pim multicast-routing);

- Assure that PIM-SM is configured on the interface (use ip pim sparse-mode);
- Multicast Protocol requires RPF Check using unicast routing; therefore the correctness of unicast routing must be assured beforehand;
- PIM-SM Protocol requires supports by RP and BSR, therefore you should use show ip pim bsr-router first to see if there is BSR information. If not, you need to check if there is unicast routing leading to BSR.
- Use show ip pim rp-hash command to check if RP information is correct; if there is not RP information, you still need to check unicast routing.

If all attempts including Check are made but the problems on PIM-SM can't be solved yet, then use debug commands such debug pim/debug pim BSR please, and then copy DEBUG information in 3 minutes and send to Technology Service Center.

43.4 MSDP Configuration

43.4.1 Introduction to MSDP

MSDP – Multicast Source Discovery Protocol, is a protocol that can learn information about multicast source in other PIM-SM domain. The RP on which MSDP is configured will advertise the information about the multicast sources in its domain to all the other MSDP entities through SA messages. Thus, all the information about multicast sources in one PIM-SM domain is spread to another. In MSDP, inter-domain information tree is used other than the shared tree. It is required that the multicast routing protocol used for in-domain routing must be PIM-SM.

- The work flow for RP in PIM-SM protocol

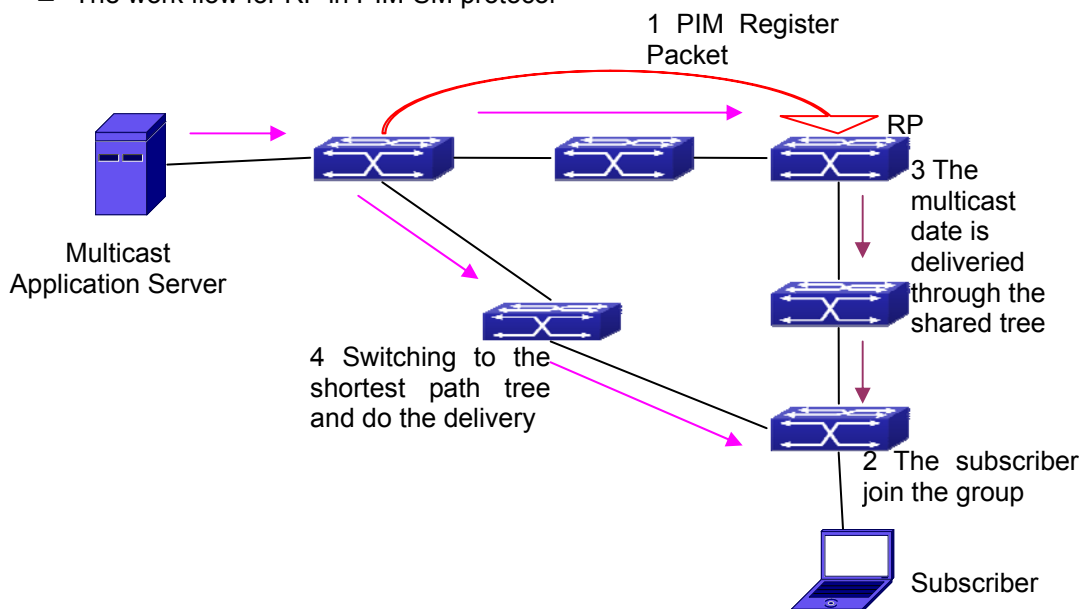

43.4.2 Brief Introduction to MSDP Configuration Tasks

1. Configuration of MSDP Basic Function
 - 1) Enabling MSDP (Required)
 - 2) Configuring MSDP entities (Required)
 - 3) Configuring the Connect-Source interface
 - 4) Configuring static RPF entities
 - 5) Configuring Originator RP
 - 6) Configuring TTL value
2. Configuration of MSDP entities
 - 1) Configuring the Connect-Source interface
 - 2) Configuring the descriptive information for MSDP entities
 - 3) Configuring the AS number
 - 4) Configuring the specified mesh group of MSDP
 - 5) Configuring the maximum size for the cache
3. Configurations on delivery of SA packets
 - 1) Configuring filter policies for creation of SA packets
 - 2) Configuring filter rules on how to receive and forward SA packets
 - 3) Configuring SA request packets
 - 4) Configuring filter policies for SA-Request packets
4. Configuration of parameters of SA-cache
 - 1) Configuring SA packets cache
 - 2) Configuring the aging time for entries in SA packets cache
 - 3) Configuring the maximum size for the cache

43.4.3 Configuration of MSDP Basic Function

All the commands in this section are configured for RP in the PIM-SM domain. These RP will function as the other peer of the MSDP entities.

43.4.3.1 Prerequisites of MSDP Configuration

Before the MSDP basic functions can be configured, the following tasks should be done:

- At least one single cast routing protocol should be configured, in order to connect the network inside the domain and outside
- Configure PIM-SM in order to implement multicast inside the domain

When configuring MSDP basic function, the following information should be ready:

- The IP address of MSDP entities
- Filter policy table

Pay attention: MSDP can not use with Any-cast RP at same time, but configure Any-cast RP of based MSDP protocol.

43.4.3.2 Enabling MSDP

MSDP should be enabled before various MSDP functions can be configured.

1. Enable the MSDP function
2. Configure MSDP

1. Enabling MSDP

Commands	Explanation
Global Configuration Mode	
router msdp no router msdp	To enable MSDP. The no form of this command will disable MSDP globally.

2. Configuration of MSDP parameters

Commands	Explanation
MSDP Configuration Mode	
connect-source <interface-type> <interface-number> no connect-source	To configure the Connect-Source interface for MSDP Peer. The no form of this command will remove the configured Connect-Source interface.
default-rpf-peer <peer-address> [rp-policy <acl-list-number> <word>] no default-rpf-peer	To configure static RPF Peer. The no form of this command will remove the configured RPF Peer.
originating-rp <interface-type> <interface-number> no originating-rp	To configure Originator-RP. The no form of this command will remove the configured Originator-RP.
ttl-threshold <tth> no ttl-threshold	To configure the TTL value. The no form of this command will remove the configured TTL value.

43.4.4 Configuration of MSDP Entities

43.4.4.1 Creation of MSDP Peer

Commands	Explanation
MSDP Configuration Mode	
peer <peer-address> no peer <peer-address>	To create an MSDP Peer. The no form of this command will remove the configured MSDP Peer.

43.4.4.2 Configuration of MSDP parameters

Commands	Explanation
MSDP Peer Configuration Mode	
connect-source <interface-type> <interface-number> no connect-source	To configure the Connect-Source interface for MSDP Peer. The no form of this command will remove the configured Connect-Source interface.
description <text> no description	To configure the descriptive information about the MSDP entities. The no form of this command will remove the configured description.
remote-as <as-num> no remote-as <as-num>	To configure the AS number for MSDP Peer. The no form of this command will remove the configured AS number of MSDP Peer.
mesh-group <name> no mesh-group <name>	To configure an MSDP Peer to join the specified mesh group. The no form of this command will remove the MSDP Peer from the specified mesh group.

43.4.5 Configuration of Delivery of MSDP Packet

Commands	Explanation
MSDP Configuration Mode	
redistribute [list <acl-list-number /acl-name>] no redistribute	To configure the filter rules for creation of SA packets. The no form of this command will remove the configured.
MSDP Configuration Mode or MSDP Peer Configuration Mode	
sa-filter (in out) [list <acl-number /acl-name> rp-list <rp-acl-number /rp-acl-name>] no sa-filter (in out) [[list <acl-number /acl-name> rp-list <rp-acl-number /rp-acl-name>]	To configure the filter rules for receiving and forwarding SA packets. The no form of this command will remove the configured rules.
MSDP Peer Configuration Mode	
sa-request no sa-request	To configure sending of SA request packets. The no form of this command will disable sending of SA request packets.
MSDP Configuration Mode	
sa-request-filter [list <access-list-number	To configure filter rules for receiving SA

access-list-name>] no sa-request-filter [list <access-list-number access-list-name>]	request packets. The no form of this command will remove the configured filter rules for SA request packets.
--	--

43.4.6 Configuration of Parameters of SA-cache

Commands	Explanation
MSDP Configuration Mode	
cache-sa-state no cache-sa-state	To enable the SA packet cache. To disable the SA packets cache.
MSDP Configuration Mode	
cache-sa-holdtime <150-3600> no cache-sa-holdtime	The aging time for entries in the SA cache. To restore the default aging time configuration.
MSDP Configuration Mode or MSDP Peer Configuration Mode	
cache-sa-maximum <sa-limit> no cache-sa-maximum	To configure the maximum size for the SA cache. To restore the size of the SA cache to the default value.

43.4.7 MSDP Configuration Examples

Example 1: MSDP basic function.

Multicast Configuration:

1. Suppose the multicast server is sending multicast datagram at 224.1.1.1;
2. The designated router – DR, which is connected to the multicast server, encapsulate the multicast datagram in the Register packets and send them to the RP(RP1) in the local domain;
3. The RP unwraps the packets and sends them to all the domain members through the shared tree. The members in the domain can be configured to be or not to be in the shared tree;
4. At the same time, the source RP in the domain, generates a SA – Source Active message, and send it to the MSDP entity – RP2.
5. If there's another member in the same domain with the MSDP entity which is named as RP3, RP3 will distribute the multicast datagram encapsulated in the SA messages to the members of the shared tree, and send join messages to the multicast source. That means RP creates an entry (S, G), and send join messages for (S, G) hop by hop, so that (S, G) can reach the SPT which takes the multicast source as the root across the PIM-SM domain.

If there no members in the same domain with MSDP entity – RP2, RP2 will not create the (S, G) entry nor it will join the SPT which takes the multicast source as the root.

- When the reverse route has been set up, the multicast datagram from the source will be directly delivered to RP3, and RP will forward the datagram to the shared tree. At this time, the router which is closest to the domain members can determine itself whether or not to switch to SPT.

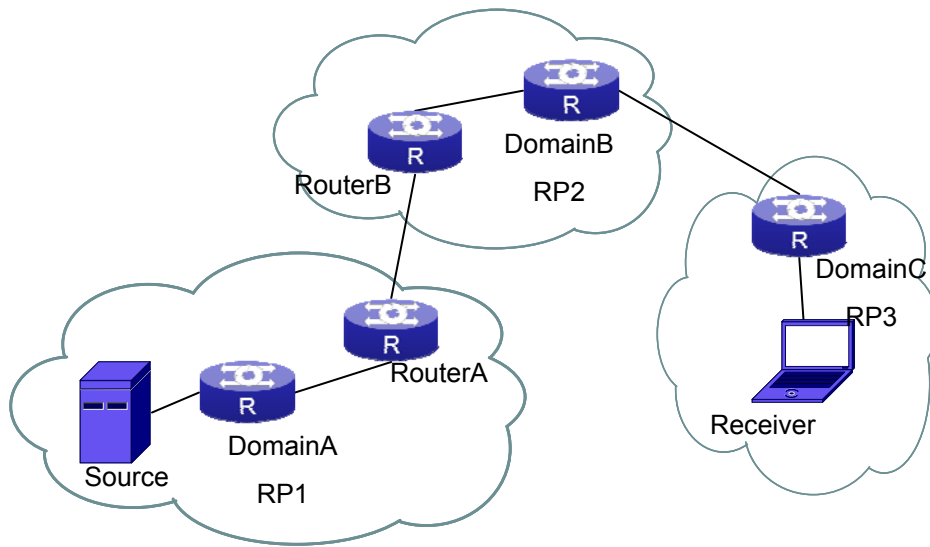

Figure 43-4-1 Network Topology for MSDP Entry

Configuration tasks are listed as below:

Prerequisites:

Enable the single cast routing protocol and PIM protocol on every router, and make sure that the inter-domain routing works well and multicasting inside the domain works well.

Suppose the multicast server S in Domain A offers multicast programs at 224.1.1.1. A host in Domain C named R subscribes this program. Before MSDP is configured C cannot subscribe the multicast program. However, with the following configuration, R is able to receive programs offered by S.

RP1 in Domain A:

```
XGS3-42000R#config
XGS3-42000R(config)#interface vlan 1
XGS3-42000R(config-if-Vlan1)#ip address 10.1.1.1 255.255.255.0
XGS3-42000R(config-if-Vlan1)#exit
XGS3-42000R(config)#router msdp
XGS3-42000R(router-msdp)#peer 10.1.1.2
```

Router A in Domain A:

```
XGS3-42000R#config
XGS3-42000R(config)#interface vlan 1
XGS3-42000R(config-if-Vlan1)#ip address 10.1.1.2 255.255.255.0
XGS3-42000R(config-if-Vlan1)#exit
XGS3-42000R(config)#interface vlan 2
XGS3-42000R(config-if-Vlan2)#ip address 20.1.1.2 255.255.255.0
XGS3-42000R(config-if-Vlan2)#exit
```

```
XGS3-42000R(config)#router msdp
XGS3-42000R(router-msdp)#peer 10.1.1.1
XGS3-42000R(msdp-peer)#exit
XGS3-42000R(router-msdp)#peer 20.1.1.1
```

Router B in Domain B:

```
XGS3-42000R#config
XGS3-42000R(config)#interface vlan 2
XGS3-42000R(config-if-Vlan2)#ip address 20.1.1.1 255.255.255.0
XGS3-42000R(config-if-Vlan2)#exit
XGS3-42000R(config)#interface vlan 3
XGS3-42000R(config-if-Vlan3)#ip address 30.1.1.1 255.255.255.0
XGS3-42000R(config-if-Vlan3)#exit
XGS3-42000R(config)#router msdp
XGS3-42000R(router-msdp)#peer 20.1.1.2
XGS3-42000R(msdp-peer)#exit
XGS3-42000R(router-msdp)#peer 30.1.1.2
```

RP2 in Domain B:

```
XGS3-42000R#config
XGS3-42000R(config)#interface vlan 3
XGS3-42000R(config-if-Vlan3)#ip address 30.1.1.2 255.255.255.0
XGS3-42000R(config)#interface vlan 4
XGS3-42000R(config-if-Vlan4)#ip address 40.1.1.2 255.255.255.0
XGS3-42000R(config-if-Vlan4)#exit
XGS3-42000R(config)#router msdp
XGS3-42000R(router-msdp)#peer 30.1.1.1
XGS3-42000R(config)#router msdp
XGS3-42000R(router-msdp)#peer 40.1.1.1
```

RP3 in Domain C:

```
XGS3-42000R(config)#interface vlan 4
XGS3-42000R(config-if-Vlan1)#ip address 40.1.1.1 255.255.255.0
XGS3-42000R(config-if-Vlan1)#exit
XGS3-42000R(config)#router msdp
XGS3-42000R(router-msdp)#peer 40.1.1.2
```

Example 2: Application of MSDP Mesh-Group.

Mesh-Group can be used to reduce flooding of SA messages. The Peers which are meshed in the same domain can be configured as a Mesh-Group. All the members in the same mesh group use a unique group name.

As it is shown in **Figure**, when Mesh-Group is configured for the four meshed Peers in the same domain, flooding of SA messages reduced remarkably.

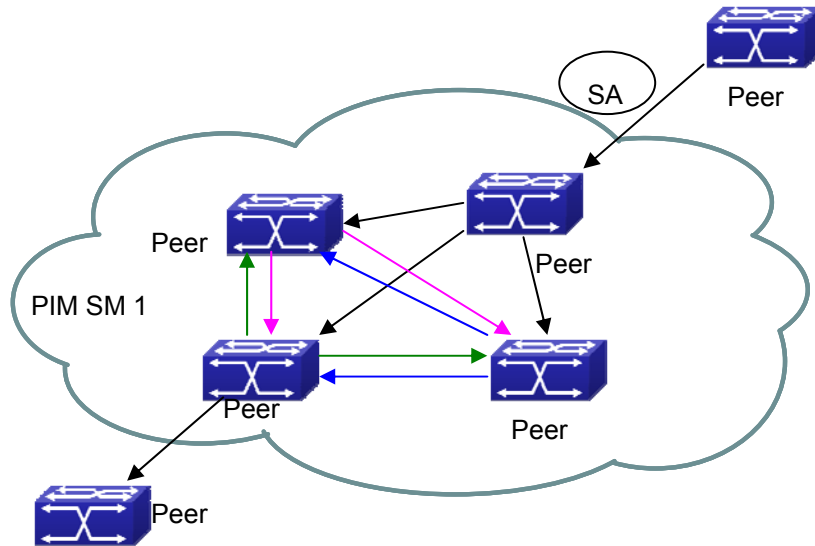

Figure 43-4-2 Flooding of SA messages

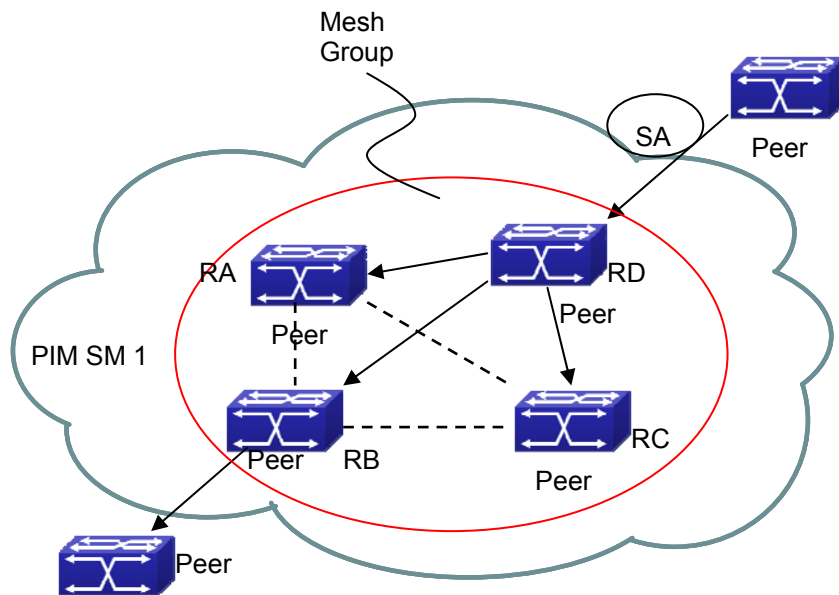

Figure 43-4-3 Flooding of SA messages with mesh group configuration

Configuration steps are listed below:

Router A:

```
XGS3-42000R#config
XGS3-42000R(config)#interface vlan 1
XGS3-42000R(config-if-Vlan1)#ip address 10.1.1.1 255.255.255.0
XGS3-42000R(config-if-Vlan1)#exit
XGS3-42000R(config)#interface vlan 2
XGS3-42000R(config-if-Vlan2)#ip address 20.1.1.1 255.255.255.0
XGS3-42000R(config-if-Vlan2)#exit
XGS3-42000R(config)#interface vlan 3
```

```
XGS3-42000R(config-if-Vlan3)#ip address 30.1.1.1 255.255.255.0
XGS3-42000R(config-if-Vlan3)#exit
XGS3-42000R(config)#router msdp
XGS3-42000R(router-msdp)#peer 10.1.1.2
XGS3-42000R(router-msdp)#mesh-group XGS3-1
XGS3-42000R(msdp-peer)#exit
XGS3-42000R(router-msdp)#peer 20.1.1.4
XGS3-42000R(router-msdp)#mesh-group XGS3-1
XGS3-42000R(msdp-peer)#exit
XGS3-42000R(router-msdp)#peer 30.1.1.3
XGS3-42000R(router-msdp)#mesh-group XGS3-1
XGS3-42000R(msdp-peer)#exit
```

Router B:

```
XGS3-42000R#config
XGS3-42000R(config)#interface vlan 1
XGS3-42000R(config-if-Vlan1)#ip address 10.1.1.2 255.255.255.0
XGS3-42000R(config-if-Vlan1)#exit
XGS3-42000R(config)#interface vlan 4
XGS3-42000R(config-if-Vlan4)#ip address 40.1.1.2 255.255.255.0
XGS3-42000R(config-if-Vlan4)#exit
XGS3-42000R(config)#interface vlan 6
XGS3-42000R(config-if-Vlan6)#ip address 60.1.1.2 255.255.255.0
XGS3-42000R(config-if-Vlan6)#exit
XGS3-42000R(config)#router msdp
XGS3-42000R(router-msdp)#peer 10.1.1.1
XGS3-42000R(router-msdp)#mesh-group XGS3-1
XGS3-42000R(msdp-peer)#exit
XGS3-42000R(router-msdp)#peer 40.1.1.4
XGS3-42000R(router-msdp)#mesh-group XGS3-1
XGS3-42000R(msdp-peer)#exit
XGS3-42000R(router-msdp)#peer 60.1.1.3
XGS3-42000R(router-msdp)#mesh-group XGS3-1
```

Router C:

```
XGS3-42000R#config
XGS3-42000R(config)#interface vlan 4
XGS3-42000R(config-if-Vlan4)#ip address 40.1.1.4 255.255.255.0
XGS3-42000R(config-if-Vlan4)#exit
XGS3-42000R(config)#interface vlan 5
XGS3-42000R(config-if-Vlan5)#ip address 50.1.1.4 255.255.255.0
XGS3-42000R(config-if-Vlan5)#exit
XGS3-42000R(config)#interface vlan 6
```

```
XGS3-42000R(config-if-Vlan6)#ip address 60.1.1.4 255.255.255.0
XGS3-42000R(config-if-Vlan6)#exit
XGS3-42000R(config)#router msdp
XGS3-42000R(router-msdp)#peer 20.1.1.1
XGS3-42000R(router-msdp)#mesh-group XGS3-1
XGS3-42000R(msdp-peer)#exit
XGS3-42000R(router-msdp)#peer 40.1.1.4
XGS3-42000R(router-msdp)#mesh-group XGS3-1
XGS3-42000R(msdp-peer)#exit
XGS3-42000R(router-msdp)#peer 60.1.1.2
XGS3-42000R(router-msdp)#mesh-group XGS3-1
```

Router D:

```
XGS3-42000R#config
XGS3-42000R(config)#interface vlan 2
XGS3-42000R(config-if-Vlan2)#ip address 20.1.1.4 255.255.255.0
XGS3-42000R(config-if-Vlan2)#exit
XGS3-42000R(config)#interface vlan 4
XGS3-42000R(config-if-Vlan1)#ip address 40.1.1.4 255.255.255.0
XGS3-42000R(config-if-Vlan1)#exit
XGS3-42000R(config)#interface vlan 5
XGS3-42000R(config-if-Vlan5)#ip address 50.1.1.4 255.255.255.0
XGS3-42000R(config-if-Vlan5)#exit
XGS3-42000R(config)#router msdp
XGS3-42000R(router-msdp)#peer 20.1.1.1
XGS3-42000R(router-msdp)#mesh-group XGS3-1
XGS3-42000R(msdp-peer)#exit
XGS3-42000R(router-msdp)#peer 40.1.1.2
XGS3-42000R(router-msdp)#mesh-group XGS3-1
XGS3-42000R(msdp-peer)#exit
XGS3-42000R(router-msdp)#peer 50.1.1.3
XGS3-42000R(router-msdp)#mesh-group XGS3-1
```

43.4.8 MSDP Troubleshooting

When MSDP is being configured, it may not function because of the physical link not working or configuration mistakes. Attention should be paid to the following items in order to make MSDP work:

- Make sure the physical link works well
- Make sure inner-domain and inter-domain routing works
- Make sure PIM-SM is applied in every domain as the inner-domain routing protocol, and configuration for PIM-SM works well
- Make sure MSDP is enabled, and the link status of the MSDP enabled Peer is UP

- Use the command **show msdp global** to check whether the MSDP configuration is correct

If the MSDP problems cannot be solved through all the methods provided above, please issue the command **debug msdp** to get the debugging messages within three minutes, and send them to the technical service center of our company.

43.5 ANYCAST RP Configuration

43.5.1 Introduction to ANYCAST RP

Anycast RP is a technology based on PIM protocol, which provides redundancy in order to recover as soon as possible once an RP becomes unusable.

The kernel concept of Anycast RP is that the RP addresses configured all over the whole network exist on multiple multicast servers (the most common situation is that every device providing ANYCAST RP uses LOOPBACK interface, and using the longest mask to configures RP addresses on this interface), while the unicast routing algorithm will make sure that PIM routers can always find the nearest RP, thus , providing a shorter and faster way to find RP in a larger network., Once an RP being used becomes unusable, the unicast routing algorithm will ensure that the PIM router can find a new RP path fast enough to recover the multicast server in time. Multiple RP will cause a new problem that is if the multicast source and the receivers are registered to different RP, some receivers will not be able to receive data of multicast source (obviously, the register messages only prefer the nearest RP). So, in order to keep the communication between all RP, Anycast RP defines that the nearest RP to the multicast source should forward the source register messages to all the other RP to guarantee that all joiners of the RP can find the multicast source.

The method to realize the PIM-protocol-based Anycast RP is that: maintaining an ANYCAST RP list on every switch configured with Anycast RP and using another address as the label to identify each other. When one Anycast RP device receives a register message, it will send the register message to other Anycast RP devices while using its own address as the source address, to notify all the other devices of the original destination.

43.5.2 ANYCAST RP Configuration Task

1. Enable ANYCAST RP v4 function
2. Configure ANYCAST RP v4

1. Enable ANYCAST RP v4 function

Command	Explanation
Global Configuration Mode	
ip pim anycast-rp no ip pim anycast-rp	Enable ANYCAST RP function. (necessary) No operation will globally disable ANYCAST RP function.

2. Configure ANYCAST RP v4

(1) Configure the RP candidate

Command	Explanation
Global Configuration Mode	
<pre>ip pim rp-candidate {vlan<vlan-id> loopback<index> <ifname>} [<A.B.C.D>] [<priority>] no ip pim rp-candidate</pre>	<p>Now, the PIM-SM has allowed the Loopback interface to be a RP candidate.(necessary)</p> <p>Please pay attention to that, ANYCAST RP protocol can configure the Loopback interface or a regular three-layer VLAN interface to be the RP candidate. In make sure that PIM routers in the network can find where the RP locates, the RP candidate interface should be added into the router.</p> <p>No operation will cancel the RP candidate configuration on this router.</p>

(2) Configure self-rp-address (the RP address of this router)

Command	Explanation
Global Configuration Mode	
<pre>ip pim anycast-rp self-rp-address A.B.C.D no ip pim anycast-rp self-rp-address</pre>	<p>Configure the self-rp-address of this router (as a RP). This address can be used to exclusively identify this router when communicating with other RP.</p> <p>the effect of self-rp-address refers to two respects:</p> <ol style="list-style-type: none"> 1 Once this router (as a RP) receives the register message from DR unicast, it needs to forward the register message to all the other RP in the network, notifying them of the state of source (S.G). While forwarding the register message, this router will change the source address of it into self-rp-address. 2 Once this router(as a RP) receives a register message from other RP unicast, such as a register message whose destination is the self-rp-address of this router, it will create (S,G) state and send back a register-stop message, whose destination address is the source address of the register message. <p>Pay attention: self-rp-address has to be the address of a three-layer interface on this router, but the configuration is allowed to be done with the absence of the interface. The</p>

	<p>self-rp-address should be unique.</p> <p>No operation will cancel the self-rp-address which is used to communicate with other RPs by this router (as a RP).</p>
--	--

(3) Configure other-rp-address (other RP communication addresses)

Command	Explanation
Global Configuration Mode	
<pre>ip pim anycast-rp <anycast-rp-addr> <other-rp-addr> no ip pim anycast-rp <anycast-rp-addr> <other-rp-addr></pre>	<p>Configure anycast-rp-addr on this router (as a RP). This unicast address is actually the RP address configured on multiple RP in the network, in accordance with the address of RP candidate interface (or Loopback interface).</p> <p>The effect of anycast-rp-addr includes:</p> <ol style="list-style-type: none"> 1 Although more than one anycast-rp-addr addresses are allowed to be configured, only the one having the same address with the currently configured RP candidate address will take effect. Only after that, can the other-rp-address in accordance with this anycast-rp-addr take effect. 2 The configuration is allowed to be done with the absence of the interface in accordance with the anycast-rp-addr. <p>Configure on this router (as a RP) the other-rp-addresses of other RP communicating with it. This unicast address identifies other RP and is used in the communication with local routers.</p> <p>The effect of other-rp-address refers to two respects:</p> <ol style="list-style-type: none"> 1 Once this router (as a RP) receives the register message from a DR unicast, it should forward it to other RP in the network to notify all the RP in the network of the source (S.G) state. While forwarding, the router will change the destination address of the register message into other-rp-address. 2 Multiple other-rp-addresses can be configured in accordance with one anycast-rp-addr, Once the register message from a DR is received, it should be forwarded to all of these other RP one by one.

No operation will cancel an other-rp-address communicating with this router.

43.5.3 ANYCAST RP Configuration Examples

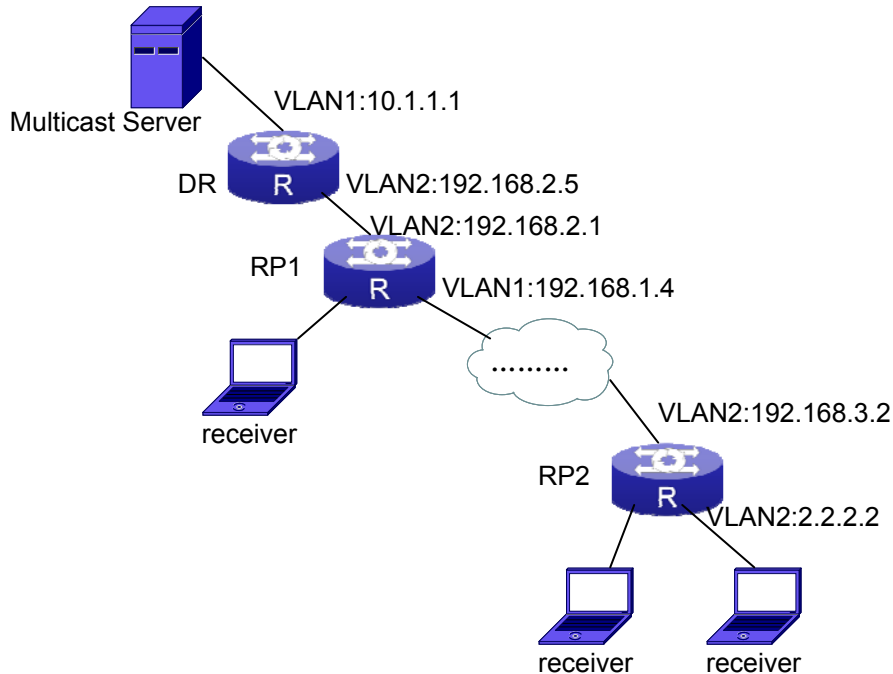

Figure 43-5-1 The ANYCAST RP v4 function of the router

As shown in the **Figure**, the overall network environment is PIM-SM, which provides two routers supporting ANYCAST RP, RP1 and RP2. Once multicast data from the multicast source server reaches the DR, the DR will send a multicast source register message to the nearest RP unicast according to the unicast routing algorithm, which is RP1 in this example. When RP1 receives the register message from the DR, besides redistributing to the shared tree according to the orders who already join it, it will forward the multicast register message to RP2 to guarantee that all orders that already join RP2 can find the multicast source. Since there is an ANYCAST list maintained on router RP1 that has been configured with ANYCAST RP, and since this list contains the unicast addresses of all the other RP in the network, when the RP1 receives the register message, it can use the self-r-address, which identifies itself as the source address to forward the register message to RP2. The cloud in the **Figure** represents the PIM-SM network operation between RP1 and RP2.

The following are the configuration steps:

RP1 Configuration:

```
XGS3-42000R#config
XGS3-42000R(config)#interface loopback 1
XGS3-42000R(config-if-Loopback1)#ip address 1.1.1.1 255.255.255.255
XGS3-42000R(config-if-Loopback1)#exit
XGS3-42000R(config)#ip pim rp-candidate loopback1
```

```
XGS3-42000R(config)#ip pim bsr-candidate vlan 1
XGS3-42000R(config)#ip pim multicast-routing
XGS3-42000R(config)#ip pim anycast-rp
XGS3-42000R(config)#ip pim anycast-rp self-rp-address 192.168.2.1
XGS3-42000R(config)#ip pim anycast-rp 1.1.1.1 192.168.3.2
```

RP2 Configuration:

```
XGS3-42000R#config
XGS3-42000R(config)#interface loopback 1
XGS3-42000R(config-if-Loopback1)#ip address 1.1.1.1 255.255.255.255
XGS3-42000R(config-if-Loopback1)#exit
XGS3-42000R(config)#ip pim rp-candidate loopback1
XGS3-42000R(config)#ip pim multicast-routing
XGS3-42000R(config)#ip pim anycast-rp
XGS3-42000R(config)#ip pim anycast-rp self-rp-address 192.168.3.2
XGS3-42000R(config)#ip pim anycast-rp 1.1.1.1 192.168.2.1
```

43.5.4 ANYCAST RP Troubleshooting

When configuring and using ANYCAST RP function, the ANYCAST RP might work abnormally because of faults in physical connections, configurations or something others. So, the users should pay attention to the following points:

- The physical connections should be guaranteed to be correct
- The PIM-SM protocol should be guaranteed to operate normally
- The ANYCAST RP should be guaranteed to be enabled in Global configuration mode
- The self-rp-address should be guaranteed to be configured correctly in Global configuration mode
- The other-rp-address should be guaranteed to be configured correctly in Global configuration mode
- All the interface routers should be guaranteed to be correctly added, including the loopback interface as a RP
- Use “**show ip pim anycast rp status**” command to check whether the configuration information of ANYCAST RP is correct

If the problems of ANYCAST still cannot be solved after checking, please use debug commands like “**debug pim anycast-rp**”, then copy the DEBUG information within three minutes and send it to the technical service center of our company.

43.6 PIM-SSM

43.6.1 Introduction to PIM-SSM

Source Specific Multicast (PIM-SSM) is a new kind of multicast service protocol. With PIM-SSM, a multicast session is distinguished by the multicast group address and multicast source address. In SSM, hosts can be added into the multicast group manually and efficiently like the traditional PIM-SM, but leave out the shared tree and RP management in PIM-SM. In SSM, SPT tree will be constructed with (S, G). G for the multicast group address and S for the source address of the multicast which sends datagram to G. (S, G) in a pair is named as a channel of SSM. SSM serves best for the application of multicast service which is from one station to many ones, for example, the network sports video channel, and the news channel. By default, the multicast group address of SSM is limited between 232.0.0.0 and 232.255.255.255. However this address range can be extended according to actual situations.

43.6.2 PIM-SSM Configuration Task List

Command	Explanation
Global Configuration Mode	
<code>ip multicast ssm {default range <access-list-number >}</code> <code>no ip multicast ssm</code>	To configure the address range for pim-ssm. The no form command will disable the configuration.

43.6.3 PIM-SSM Configuration Examples

As the figure shows, ethernet interfaces from SwitchA, SwitchB, SwitchC, and SwitchD are configured to be in separate VLANs. And PIM-SSM is enabled globally by enabling the PIM-SM or PIM-DM protocol on the VLAN interfaces. Take PIM-SM for example.

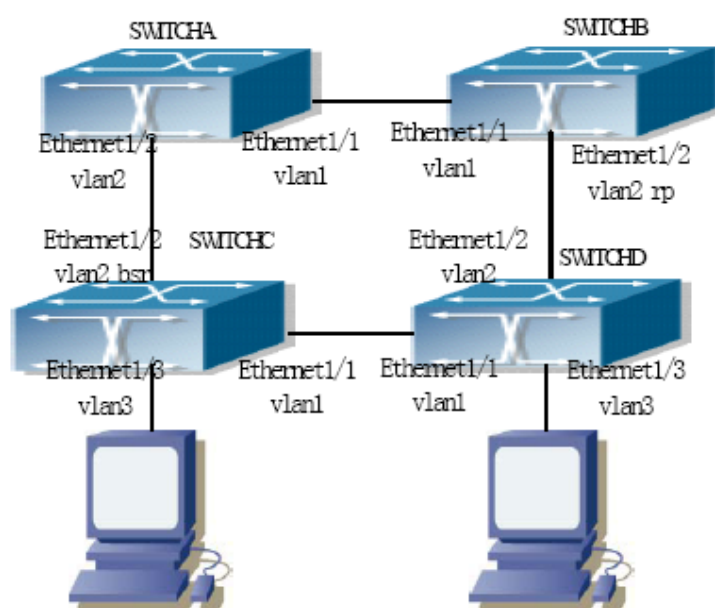

Figure 46-3-1 PIM-SSM typical environment

Configurations of SwitchA, SwitchB, SwitchC, and SwitchD are shown below.

(1) Configuration of Switch A

```
XGS3-42000R(config)#ip pim multicast-routing
XGS3-42000R(config)#interface vlan 1
XGS3-42000R(config-lf-Vlan1)# ip pim sparse-mode
XGS3-42000R(config-lf-Vlan1)#exit
XGS3-42000R(config)#interface vlan 2
XGS3-42000R(config-lf-Vlan2)# ip pim sparse-mode
XGS3-42000R(config-lf-Vlan2)#exit
XGS3-42000R(config)#access-list 1 permit 224.1.1.1 0.0.0.255
XGS3-42000R(config)#ip multicast ssm range 1
```

(2) Configuration of Switch B

```
XGS3-42000R(config)#ip pim multicast-routing
XGS3-42000R(config)#interface vlan 1
XGS3-42000R(config-lf-Vlan1)# ip pim sparse-mode
XGS3-42000R(config-lf-Vlan1)#exit
XGS3-42000R(config)#interface vlan 2
XGS3-42000R(config-lf-Vlan2)# ip pim sparse-mode
XGS3-42000R(config-lf-Vlan2)# exit
XGS3-42000R(config)# ip pim rp-candidate vlan2
XGS3-42000R(config)#access-list 1 permit 224.1.1.1 0.0.0.255
XGS3-42000R(config)#ip multicast ssm range 1
```

(3) Configuration of Switch C

```
XGS3-42000R(config)#ip pim multicast-routing
XGS3-42000R(config)#interface vlan 1
XGS3-42000R(config-lf-Vlan1)# ip pim sparse-mode
XGS3-42000R(config-lf-Vlan1)#exit
XGS3-42000R(config)#interface vlan 2
XGS3-42000R(config-lf-Vlan2)# ip pim sparse-mode
XGS3-42000R(config-lf-Vlan2)#exit
XGS3-42000R(config)#interface vlan 3
XGS3-42000R(config-lf-Vlan3)# ip pim sparse-mode
XGS3-42000R(config-lf-Vlan3)# exit
XGS3-42000R(config)# ip pim bsr-candidate vlan2 30 10
XGS3-42000R(config)#access-list 1 permit 224.1.1.1 0.0.0.255
XGS3-42000R(config)#ip multicast ssm range 1
```

(4) Configuration of Switch D

```
XGS3-42000R(config)#ip pim multicast-routing
XGS3-42000R(config)#interface vlan 1
XGS3-42000R(config-if-Vlan1)# ip pim sparse-mode
XGS3-42000R(config-if-Vlan1)#exit
XGS3-42000R(config)#interface vlan 2
XGS3-42000R(config-if-Vlan2)# ip pim sparse-mode
XGS3-42000R(config-if-Vlan2)#exit
XGS3-42000R(config)#interface vlan 3
XGS3-42000R(config-if-Vlan3)# ip pim sparse-mode
XGS3-42000R(config-if-Vlan3)#exit
XGS3-42000R(config)#access-list 1 permit 224.1.1.1 0.0.0.255
XGS3-42000R(config)#ip multicast ssm range 1
```

43.6.4 PIM-SSM Troubleshooting

In configuring and using PIM-SSM Protocol, PIM-SSM Protocol might not operate normally caused by physical connection or incorrect configuration. Therefore, the user should pay attention to the following issues:

- Assure that physical connection is correct;
- Assure the Protocol of Interface and Link is UP (use **show interface** command);
- Assure that PIM Protocol is enabled in Global Mode (use **ip pim multicast-routing**);
- Assure that PIM-SSM is configured on the interface (use **ip pim sparse-mode**);
- Assure that SSM is configured in Global Mode;
- Multicast Protocol requires RPF check using unicast routing, therefore the correctness of unicast routing must be assured beforehand.

If all attempts including check are made but the problems on PIM-SSM can't be solved yet, then use debug commands such **debug pim event/debug pim packet** please, and then copy DEBUG information in 3 minutes and send to Technology Service Center.

43.7 DVMRP

43.7.1 Introduction to DVMRP

DVMRP Protocol, namely, is "Distance Vector Multicast Routing Protocol". It is a Multicast Routing Protocol in dense mode, which sets up a Forward Broadcast Tree for each source in a manner similar to RIP, and sets up a Truncation Broadcast Tree, i.e. the Shortest Path Tree to the source, for each source through dynamic Prune/Graft.

Some of the important features of DVMRP are:

1. The routing exchange used to determine reverse path checking information is based on distance vector (in a manner similar to RIP)

2. Routing exchange update occurs periodically (the default is 60 seconds)
3. TTL upper limit = 32 hops (and that RIP is 16)
4. Routing update includes net mask and supports CIDR

In comparison with Unicast routing, Multicast routing is a kind of reverse routing (that is, what you are interested in is where the packets are from but not where they go), thus the information in DVMRP routing table is used to determine if an input Multicast packet is received at the correct interface. Otherwise, the packet will be discarded to prevent Multicast circulation.

The check which determines if the packet gets to the correct interface is called RPF check. When some Multicast data packets get to some interface, it will determine the reverse path to the source network by looking up DVMRP router table. If the interface data packets get to is the one which is used to send Unicast message to the source, then the reverse path check is correct, and the data packets are forwarded out from all downstream interfaces. If not, then probably there is failure, and the Multicast packet is discarded.

Since not all switches support Multicast, DVMRP supports tunnel multicast communication, tunnel is a method to send multicast data report among DVMRP switches separated by switches which don't support multicast routing. Multicast data packets are encapsulated in unicast data packets and directly sent to the next switch which supports multicast. DVMRP Protocol treats tunnel interface and general physical interface equally.

If two or more switches are connected to a multi-entrance network, it is likely to transmit more than one copy of a data packet to the sub-network. Thus a specified transmitter must be appointed. DVMRP achieves this goal by making use of routing exchange mechanism; when two switches on the multi-entrance network exchange routing information, they will be aware of the routing distance from each other to the source network, thus the switch with the shortest distance to the source network will become the specified transmitter of the sub-network. If some have the same distance, then the one with the lowest IP prevails.

After some interface of the switch is configured to Function DVMRP Protocol, the switch will multicast Probe message to other DVMRP switches on this interface, which is used to find neighbors and detect the capabilities of each other. If no Probe message from the neighbor is received until the neighbor is timed out, then this neighbor is considered missing.

In DVMRP, source network routing selection message are exchanged in a basic manner same to RIP. That is, routing report message is transmitted among DVMRP neighbors periodically (the default is 60 seconds). The routing information in DVMRP routing selection table is used to set up source distribution tree, i.e. to determine by which neighbor it passes to get to the source transmitting multicast packet; the interface to this neighbor is called upstream interface. The routing report includes source network (use net mask) address and the hop entry for routing scale.

In order to finish transmission correctly, every DVMRP switch needs to know which downstream switches need to receive multicast packet from some specific source network through it. After receiving packets from some specific source, DVMRP switch firstly will broadcast these multicast packets from all downstream interfaces, i.e. the interfaces on which there are other DVMRP switches which have dependence on the specific source. After receiving Prune message from some downstream switch on the interface, it will prune

this switch. DVMRP switch makes use of poison reverse to notify the upstream switch for some specific source: "I am your downstream." By adding infinity (32) to the routing distance of some specific source it broadcasts, DVMRP switch responds to the source upstream exchange to fulfill poison reverse. This means distance correct value is 1 to 2* infinity (32) -1 or 1 to 63, 1 to 63 means it can get to source network, 32 means source network is not arrival, 33 to 63 means the switch which generates the report message will receive multicast packets from specific source depending on upstream router.

43.7.2 DVMRP Configuration Task List

- 1 · Globally enable and disable DVMRP (Required)
- 2 · Configure Enable and Disable DVMRP Protocol at the interface (Required)
- 3 · Configure DVMRP Sub-parameters (Optional)
 - Configure DVMRP interface parameters
 - 1) Configure the delay of transmitting report message on DVMRP interface and the message number each time it transmits
 - 2) Configure metric value of DVMRP interface
 - 3) Configure if DVMRP is able to set up neighbors with DVMRP routers which can not Prune/Graft
- 4 · Configure DVMRP tunnel

1. Globally enable DVMRP Protocol

The basic configuration to function DVMRP routing protocol on XGS3 series Layer 3 switch is very simple. Firstly it is required to turn on DVMRP switch globally.

Command	Explanation
Global Mode	
[no] ip dvmrp multicast-routing	Globally enable DVMRP Protocol, the " no ip dvmrp multicast-routing " command disables DVMRP Protocol globally. (Required)

2. Enable DVMRP Protocol on the interface

The basic configuration to function DVMRP routing protocol on XGS3 series Layer 3 switch is very simple. After globally enabling DVMRP Protocol, it is required to turn on DVMRP switch under corresponding interface.

Command	Explanation
Interface Configuration Mode	
ip dvmrp no ip dvmrp	Enable DVMRP Protocol on the interface, the " no ip dvmrp " command disables DVMRP Protocol on the interface.

3. Configure DVMRP Sub-parameters

- (1) Configure DVMRP Interface Parameters
 - 1) Configure the delay of transmitting report message on DVMRP interface and the message number each time it transmits
 - 2) Configure metric value of DVMRP interface

3) Configure if DVMRP is able to set up neighbors with DVMRP routers which can not Prune/Graft

Command	Explanation
Interface Configuration Mode	
ip dvmrp output-report-delay <delay_val> [<burst_size>] no ip dvmrp output-report-delay	Configure the delay of transmitting DVMRP report message on interface and the message number each time it transmits, the “ no ip dvmrp output-report-delay ” command restores default value.
ip dvmrp metric <metric_val> no ip dvmrp metric	Configure interface DVMRP report message metric value; the “ no ip dvmrp metric ” command restores default value.
ip dvmrp reject-non-pruners no ip dvmrp reject-non-pruners	Configure the interface rejects to set up neighbor relationship with non pruning/grafting DVMRP router. The “ no ip dvmrp reject-non-pruners ” command restores to being able to set up neighbor ship.

4. Configure DVMRP Tunnel

Command	Explanation
Interface Configuration Mode	
ip dvmrp tunnel <index> <src-ip> <dst-ip> no ip dvmrp tunnel {<index> <src-ip> <dst-ip>}	This command configures a DVMRP tunnel; the “ no ip dvmrp tunnel {<index> <src-ip> <dst-ip>} ” command deletes a DVMRP tunnel.

43.7.3 DVMRP Configuration Examples

As shown in the following figure, add the Ethernet interfaces of Switch A and Switch B to the corresponding VLAN, and enable DVMRP on each VLAN interface.

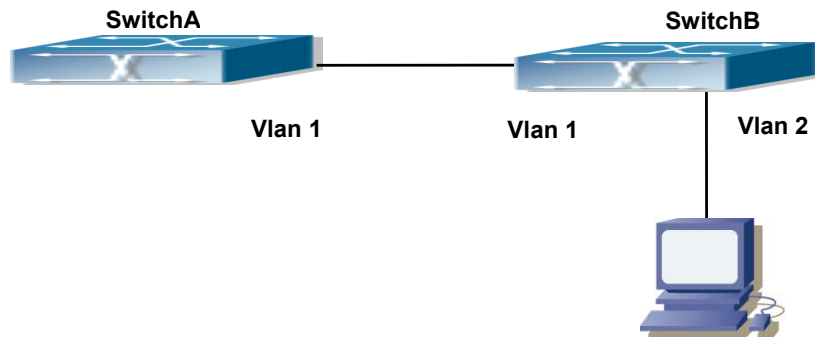

Figure 43-7-1 DVMRP Network Topology Diagram

The configuration procedure for SwitchA and SwitchB is as follows:

(1) Configure SwitchA:

```
XGS3-42000R(config)#ip dvmrp multicast-routing
XGS3-42000R(config)#interface vlan 1
XGS3-42000R(config-if-Vlan1)# ip address 10.1.1.1 255.255.255.0
XGS3-42000R(config-if-Vlan1)# ip dvmrp enable
```

(2) Configure SwitchB:

```
XGS3-42000R(config)#ip dvmrp multicast-routing
XGS3-42000R(config)#interface vlan 1
XGS3-42000R(config-if-Vlan1)# ip address 12.1.1.2 255.255.255.0
XGS3-42000R(config-if-Vlan1)# ip dvmrp enable
XGS3-42000R(config-if-Vlan1)#exit
XGS3-42000R(config)#interface vlan 2
XGS3-42000R(config-if-Vlan2)# ip address 20.1.1.1 255.255.255.0
XGS3-42000R(config-if-Vlan2)# ip dvmrp
```

Since DVMRP itself does not rely on Unicast Routing Protocol, it is not necessary to configure Unicast Routing Protocol. This is the difference from PIM-DM and PIM-SM.

43.7.4 DVMRP Troubleshooting

In configuring and using DVMRP Protocol, DVMRP Protocol might not operate normally caused by physical connection or incorrect configuration. Therefore, the user should pay attention to the following issues:

- Firstly to assure that physical connection is correct;
- Next, to assure the Protocol of Interface and Link is UP (use **show interface** command);
- Please check if the correct IP address is configured on the interface (use **ip address** command);
- Afterwards, enable DVMRP Protocol on the interface (use **ip dvmrp** command and **ip dv multicast-routing** command);
- Multicast Protocol requires RPF Check using unicast routing; therefore the correctness of unicast routing must be assured beforehand. (DVMRP uses its own unicast table, please use **show ip dvmrp route** command to look up).

If all attempts including Check are made but the problems on DVMRP can't be solved yet, then please use commands such as debug DVMRP, and then copy DEBUG information in 3 minutes and send to Technology Service Center.

43.8 DCSCM

43.8.1 Introduction to DCSCM

DCSCM (Destination control and source control multicast) technology mainly includes three aspects, i.e. Multicast Packet Source Controllable, Multicast User Controllable and Service-Oriented Priority Strategy Multicast.

The Multicast Packet Source Controllable technology of Security Controllable Multicast technology is mainly processed in the following manners:

- 1 · On the edge switch, if source under-control multicast is configured, then only multicast data from specified group of specified source can pass.
- 2 · For RP switch in the core of PIM-SM, for REGISTER information out of specified source and specified group, REGISTER_STOP is transmitted directly and table entry is not allowed to set up. (This task is implemented in PIM-SM model).

The implement of Multicast User Controllable technology of Security Controllable Multicast technology is based on the control over IGMP report message sent out by the user, thus the model being controlled is IGMP snooping and IGMP model, of which the control logic includes the following three, i.e. to take control based on VLAN+MAC address transmitting packets, to take control based on IP address of transmitting packets and to take control based on the port where messages enter, in which IGMP snooping can use the above three methods to take control simultaneously, while since IGMP model is located at layer 3, it only takes control over the IP address transmitting packets .

The Service-Oriented Priority Strategy Multicast of Security Controllable technology adopts the following mode: for multicast data in limit range, set the priority specified by the user at the join-in end so that data can be sent in a higher priority on TRUNK port, consequently guarantee the transmission is processed in user-specified priority in the entire network.

43.8.2 DCSCM Configuration Task List

1. Source Control Configuration
2. Destination Control Configuration
3. Multicast Strategy Configuration

1 · Source Control Configuration

Source Control Configuration has three parts, of which the first is to enable source control. The command of source control is as follows:

Command	Explanation
Global Configuration Mode	
[no] ip multicast source-control (Required)	Enable source control globally, the “ no ip multicast source-control ” command disables source control globally. It is noticeable that, after enabling source control globally, all multicast packets are discarded by default. All source control configuration can not be processed until that it is enabled globally, while source control can not be disabled until all configured rules are disabled.

The next is to configure the rule of source control. It is configured in the same manner as for ACL, and uses ACL number of 5000-5099, every rule number can be used to configure 10 rules. It is noticeable that these rules are ordered, the front one is the one which is configured the earliest. Once the configured rules are matched, the following rules won't take effect, so rules of globally allow must be put at the end. The commands are as follows:

Command	Explanation
Global Configuration Mode	
[no] access-list <5000-5099> {deny permit} ip {{<source> <source-wildcard>}{host-source <source-host-ip>} any-source} {{<destination> <destination-wildcard>}{host-destination <destination-host-ip>} any-destination}	The rule used to configure source control. This rule does not take effect until it is applied to specified port. Using the NO form of it can delete specified rule.

The last is to configure the configured rule to specified port.

Note: If the rules being configured will occupy the table entries of hardware, configuring too many rules will result in configuration failure caused by bottom table entries being full, so we suggest user to use the simplest rules if possible. The configuration rules are as follows:

Command	Explanation
Port Configuration Mode	
[no] ip multicast source-control access-group <5000-5099>	Used to configure the rules source control uses to port, the NO form cancels the configuration.

2 · Destination Control Configuration

Like source control configuration, destination control configuration also has three steps.

First, enable destination control globally. Since destination control need to prevent unauthorized user from receiving multicast data, the switch won't broadcast the multicast data it received after configuring global destination control. Therefore, It should be avoided to connect two or more other Layer 3 switches in the same VLAN on a switch on which destination control is enabled. The configuration commands are as follows:

Command	Explanation
Global Configuration Mode	
[no] multicast destination-control (required)	Globally enable IPv4 and IPv6 destination control. The no operation of this command will globally disable destination control. All of the other configuration can only take effect after globally enabled. The next is configuring destination control rules, which are similar.

Next is to configure destination control rule. It is similar to source control, except to use ACL No. of 6000-7999.

Command	Explanation
Global Configuration Mode	
[no] access-list <6000-7999> {deny permit} ip {{<source> <source-wildcard>}{host-source <source-host-ip>} any-source} {{<destination> <destination-wildcard>}{host-destination <destination-host-ip>} any-destination}	The rule used to configure destination control. This rule does not take effect until it is applied to source IP or VLAN-MAC and port. Using the NO form of it can delete specified rule.

The last is to configure the rule to specified source IP, source VLAN MAC or specified port. It is noticeable that, due to the above situations, these rules can only be used globally in enabling IGMP-SNOOPING. And if IGMP-SNOOPING is not enabled, then only source IP rule can be used under IGMP Protocol. The configuration commands are as follows:

Command	Explanation
Port Configuration Mode	
[no] ip multicast destination-control access-group <6000-7999>	Used to configure the rules destination control uses to port, the NO form cancels the configuration.
Global Configuration Mode	

[no] ip multicast destination-control <1-4094> <macaddr> access-group <6000-7999>	Used to configure the rules destination control uses to specify VLAN-MAC, the NO form cancels the configuration.
[no] ip multicast destination-control <IPADDRESS/M> access-group <6000-7999>	Used to configure the rules destination control uses to specified IP address/net mask, the NO form cancels the configuration.

3 · Multicast Strategy Configuration

Multicast Strategy uses the manner of specifying priority for specified multicast data to achieve and guarantee the effects the specific user requires. It is noticeable that multicast data can not get a special care all along unless the data are transmitted at TRUNK port. The configuration is very simple, it has only one command, i.e. to set priority for the specified multicast. The commands are as follows:

Command	Explanation
Global Configuration Mode	
[no] ip multicast policy <IPADDRESS/M> <IPADDRESS/M> cos <priority>	Configure multicast strategy, specify priority for sources and groups in specific range, and the range is <0-7>.

43.8.3 DCSCM Configuration Examples

1 · Source Control

In order to prevent an Edge Switch from putting out multicast data ad asbitsium, we configure Edge Switch so that only the switch at port Ethernet1/5 is allowed to transmit multicast, and the data group must be 225.1.2.3. Also, switch connected up to port Ethernet1/10 can transmit multicast data without any limit, and we can make the following configuration.

```
EC(config)#access-list 5000 permit ip any host 225.1.2.3
EC(config)#access-list 5001 permit ip any any
EC(config)#ip multicast source-control
EC(config)#interface ethernet1/5
EC(Config-If-Ethernet1/5)#ip multicast source-control access-group 5000
EC(config)#interface ethernet1/10
EC(Config-If-Ethernet1/10)#ip multicast source-control access-group 5001
```

2 · Destination Control

We want to limit users with address in 10.0.0.0/8 network segment from entering the group of 238.0.0.0/8, so we can make the following configuration:

Firstly enable IGMP snooping in the VLAN it is located (Here it is assumed to be in VLAN2)

```
EC(config)#ip igmp snooping
EC(config)#ip igmp snooping vlan 2
```

After that, configure relative destination control access-list, and configure specified IP address to use that access-list.

```
XGS3-42000R(config)#access-list 6000 deny ip any 238.0.0.0 0.255.255.255
XGS3-42000R(config)#access-list 6000 permit ip any any
XGS3-42000R(config)#multicast destination-control
XGS3-42000R(config)#ip multicast destination-control 10.0.0.0/8 access-group 6000
```

In this way, users of this network segment can only join groups other than 238.0.0.0/8.

3 · Multicast strategy

Server 210.1.1.1 is distributing important multicast data on group 239.1.2.3, we can configure on its join-in switch as follows:

```
XGS3-42000R(config)#ip multicast policy 210.1.1.1/32 239.1.2.3/32 cos 4
```

In this way, the multicast stream will have a priority of value 4 (Usually this is pretty higher, the higher possible one is protocol data; if higher priority is set, when there is too many multicast data, it might cause abnormal behavior of the switch protocol) when it gets to other switches through this switch.

43.8.4 DCSCM Troubleshooting

The effect of DCSCM module itself is similar to ACL, and the problems occurred are usually related to improper configuration. Please read the descriptions above carefully. If you still can not determine the cause of the problem, please send your configurations and the effects you expect to the after-sale service staff of our company.

43.9 IGMP

43.9.1 Introduction to IGMP

IGMP (Internet Group Management Protocol) is the protocol in TCP/IP protocol family which is responsible for IP multicast member management. It is used to set up and maintain multicast group member relationship between IP host and its neighbor multicast switches. IGMP does not include the spread and maintenance of relation information of group members among multicast switches, this work is accomplished by each multicast routing protocol. All hosts participating in multicast must implement IGMP protocol.

Hosts participating IP multicast can join in and exit multicast group at any location, any time and without limit of member total. Multicast switch does not need and not likely to save all relationships of all hosts. It only gets to know if there are receivers of some multicast group, i.e. group member, on the network segment each interface connects to. And the host only needs to save which multicast groups it joined.

IGMP is asymmetric between host and router: the host needs to respond the IGMP query messages of multicast switches, i.e. to report message response in membership; the switch sends out membership query messages periodically, and then determine if there are hosts of some specific group joining in the sub-network it belongs to based on the received response message, and send out query of specific group (IGMP version2) when receiving the report of a host exiting the group to determine if there exists no member in some specific group.

Up to now, there are three versions of IGMP: IGMP version1 (defined by RFC1112), IGMP version2 (defined by RFC2236) and IGMP version3 (defined by RFC3376).

The main improvements of IGMP version2 over version1 are:

1. The election mechanism of multicast switches on the shared network segment

Shared network segment is the situation of there is more than one multicast switch on a network segment. Under this kind of situation, since all switches which runs IGMP under this network segment can get membership report message from the host, therefore, only one switch is required to transmit membership query message, so an exchange election mechanism is required to determine a switch as query machine. In IGMP version1, the selection of query machine is determined by Multicast Routing Protocol; IGMP version2 made an improvement for it, it prescribed that when there are more than one multicast switches on the same network segment, the multicast switch with the lowest IP address will be elected as the query machine.

2. IGMP version2 added Leave Group Mechanism

In IGMP version 1, the host leaves the multicast group silently without sending any notification to any multicast switch. This causes that the multicast switch can only determine the leave of multicast member by multicast group response time-out. But in version2, when a host decides to leave a multicast group, if it is the host which gives response to the latest membership query message, then it will send out a message implying it is leaving.

3. IGMP version 2 added the query to specific group

In IGMP version1, a query of multicast switch is for all multicast groups on the network segment. This query is called general group query. In IGMP version2, query of specific group is added besides general group query. The destination IP address of this kind of query message is the IP address of the multicast group, the group address field part of the message is also the IP address of the multicast group. Thus it is prevented that hosts which are other multicast group members transmit response message.

4. IGMP version2 added the biggest response time field

IGMP version2 added the biggest response time field to dynamically adjust the response time of the host to group query message.

The main features of version3 is allowing the host to choose receiving from or rejecting a certain source, which is the basis of SSM (Source-Specific Multicast) multicast. For example, when a host is sending a report of INCLUDE{10.1.1.1, 10.1.1.2} to some group G, that means the host needs the router to forward the flux from 10.1.1.1 and 10.1.1.2; when a host is sending a report of EXCLUDE{192.168.1.1} to some group G, that means the host needs the flux from all sources of group G except 192.168.1.1. This makes a great difference from the previous IGMP.

The main improvements of IGMP Version3 over IGMP Version1 and Version2 are:

1. The status to be maintained is group and source list, not only the groups in IGMPv2.
2. The interoperations with IGMPv1 and IGMPv2 are defined in IGMPv3 status.

3. IP service interface is modified to allow specific source list thereby.
4. The queried includes his/her Robustness Variable and Query Interval in query group to allow the synchronization with these variables of non-queries.
5. Max Response Time in Query Message has an exponential range, with maximum value from 25.5 secs of v2 to 53 mins, which can be used in links of great capacity.
6. In order to increase strength, the host retransmits State-Change message.
7. Additional data is defined to adapt future extension.
8. Report group is sent to 224.0.0.22 to help with IGMP Snooping of Layer 2 Switch.
9. Report group can include more than one group record, and it allows using small group to report complete current status.
10. The host does not restrain operation any more, which simplifies the implement and allows direct membership trace.
11. In querying messages, the new router side restraint process (S sign) modified the existing strength of IGMPv2.

43.9.2 IGMP Configuration Task List

- 1 · Enable IGMP (Required)
- 2 · Configure IGMP sub-parameters (Optional)
 - (1) Configure IGMP group parameters
 - 1) Configure IGMP group filtering conditions
 - 2) Configure IGMP to join in group
 - 3) Configure IGMP to join in static group
 - (2) Configure IGMP query parameters
 - 1) Configure the interval of IGMP sending query message
 - 2) Configure the maximum response time of IGMP query
 - 3) Configure time-out of IGMP query
 - (3) Configure IGMP version
- 3 · Disable IGMP Protocol

1. Enable IGMP Protocol

There are not specific commands for enabling IGMP Protocol on the Layer 3 switch. Enabling any multicast protocol under corresponding interface will automatically enable IGMP.

Command	Explanation
Global Mode	
ip dvmrp multicast-routing ip pim multicast-routing	To enable global multicast protocol is the prerequisite to enable IGMP protocol, the “ no ip dvmrp multicast-routing no ip pim multicast-routing ” commands disable multicast protocol and IGMP protocol. (Required)

Command	Explanation
Interface Configuration Mode	
ip dvmrp enable ip pim dense-mode ip pim sparse-mode	Enable IGMP Protocol, the corresponding commands “ no ip dvmrp enable no ip pim dense-mode no ip pim sparse-mode ” disable IGMP Protocol. (Required)

2. Configure IGMP Sub-parameters

(1) Configure IGMP group parameters

- 1) Configure IGMP group filtering conditions
- 2) Configure IGMP to join in group
- 3) Configure IGMP to join in static group

Command	Explanation
Interface Configuration Mode	
ip igmp access-group {<acl_num / acl_name>} no ip igmp access-group	Configure the filtering conditions of the interface to IGMP group; the “ no ip igmp access-group ” command cancels the filtering condition.
ip igmp join-group <A.B.C.D> no ip igmp join-group <A.B.C.D>	Configure the interface to join in some IGMP group, the “ no ip igmp join-group <A.B.C.D> ” command cancels the join.
ip igmp static-group <A.B.C.D> no ip igmp static-group <A.B.C.D>	Configure the interface to join in some IGMP static group; the “ no ip igmp static-group <A.B.C.D> ” command cancels the join.

(2) Configure IGMP Query parameters

- 1) Configure interval for IGMP to send query messages
- 2) Configure the maximum response time of IGMP query
- 3) Configure the time-out of IGMP query

Command	Explanation
Interface Configuration Mode	
ip igmp query-interval <time_val> no ip igmp query-interval	Configure the interval of IGMP query messages sent periodically; the “ no ip igmp query-interval ” command restores default value.
ip igmp query-max-response-time <time_val> no ip igmp query-max-response-time	Configure the maximum response time of the interface for IGMP query; the “ no ip igmp query-max-response-time ” command restores default value.
ip igmp query-timeout <time_val> no ip igmp query-timeout	Configure the time-out of the interface for IGMP query; the “ no ip igmp query-timeout ” command restores default value.

(3) Config IGMP version

Command	Explanation
Global Mode	
ip igmp version <version> no ip igmp version	Configure IGMP version on the interface; the “ no ip igmp version ” command restores the default value.

3. Disable IGMP Protocol

Command	Explanation
Interface Configuration Mode	
no ip dvmrp no ip pim dense-mode no ip pim sparse-mode no ip dvmrp multicast-routing no ip pim multicast-routing	Disable IGMP Protocol.

43.9.3 IGMP Configuration Examples

As shown in the following figure, add the Ethernet ports of Switch A and Switch B to corresponding VLAN, and start PIM-DM on each VLAN interface.

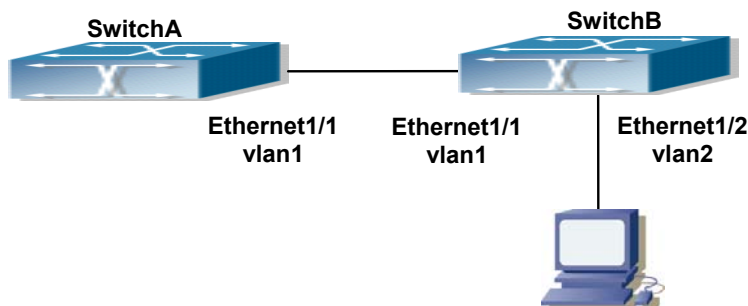

Figure 43-9-1 IGMP Network Topology Diagram

The configuration procedure for SwitchA and SwitchB is as follows:

(1) Configure SwitchA:

```
XGS3-42000R(config)#ip pim multicast-routing
XGS3-42000R(config)#interface vlan 1
XGS3-42000R(config-if-Vlan1)#ip address 12.1.1.1 255.255.255.0
XGS3-42000R(config-if-Vlan1)#ip pim dense-mode
```

(2) Configure SwitchB:

```
XGS3-42000R(config)#ip pim multicast-routing
XGS3-42000R(config)#interface vlan1
XGS3-42000R(config-if-Vlan1)#ip address 12.1.1.2 255.255.255.0
XGS3-42000R(config-if-Vlan1)#ip pim dense-mode
XGS3-42000R(config-if-Vlan1)#exit
XGS3-42000R(config)#interface vlan2
XGS3-42000R(config-if-Vlan1)#ip address 20.1.1.1 255.255.255.0
XGS3-42000R(config-if-Vlan2)#ip pim dense-mode
XGS3-42000R(config-if-Vlan2)#ip igmp version 3
```

43.9.4 IGMP Troubleshooting

In configuring and using IGMP Protocol, IGMP Protocol might not operate normally caused by physical connection or incorrect configuration. Therefore, user should pay attention to the following issues:

- Firstly to assure that physical connection is correct;
- Next, to assure the Protocol of Interface and Link protocol is UP (use show interface command);
- Afterwards, to assure to start a kind of multicast protocol on the interface;
- Multicast Protocol requires RPF Check using unicast routing; therefore the correctness of unicast routing must be assured beforehand.

43.10 IGMP Snooping

43.10.1 Introduction to IGMP Snooping

IGMP (Internet Group Management Protocol) is a protocol used in IP multicast. IGMP is used by multicast enabled network device (such as a router) for host membership query, and by hosts that are joining a multicast group to inform the router to accept packets of a certain multicast address. All those operations are done through IGMP message exchange. The router will use a multicast address (224.0.0.1) that can address to all hosts to send an IGMP host membership query message. If a host wants to join a multicast group, it will reply to the multicast address of that a multicast group with an IGMP host membership reports a message.

IGMP Snooping is also referred to as IGMP listening. The switch prevents multicast traffic from flooding through IGMP Snooping, multicast traffic is forwarded to ports associated to multicast devices only. The switch listens to the IGMP messages between the multicast router and hosts, and maintains multicast group forwarding table based on the listening result, and can then decide to forward multicast packets according to the forwarding table.

Switch provides IGMP Snooping and is able to send a query from the switch so that the user can use switch in IP multicast.

43.10.2 IGMP Snooping Configuration Task List

1. Enable IGMP Snooping
2. Configure IGMP Snooping

1. Enable IGMP Snooping

Command	Explanation
Global Mode	
ip igmp snooping no ip igmp snooping	Enables IGMP Snooping. The no operation disables IGMP Snooping function.

2. Configure IGMP Snooping

Command	Explanation
Global Mode	
ip igmp snooping vlan <vlan-id> no ip igmp snooping vlan <vlan-id>	Enables IGMP Snooping for specified VLAN. The no operation disables IGMP Snooping for specified VLAN.
ip igmp snooping vlan <vlan-id> limit {group <g_limit> source <s_limit>} no ip igmp snooping vlan <vlan-id> limit	Configure the max group count of vlan and the max source count of every group. The “ no ip igmp snooping vlan <vlan-id> limit ” command cancels this configuration.
ip igmp snooping vlan <vlan-id> l2-general-querier no ip igmp snooping vlan <vlan-id> l2-general-querier	Set this vlan to layer 2 general querier. It is recommended to configure a layer 2 general querier on a segment. The “ no ip igmp snooping vlan <vlan-id> l2-general-querier ” command cancels this configuration.
ip igmp snooping vlan <vlan-id> l2-general-querier-version <version>	Configure the version number of a general query from a layer 2 general querier.
ip igmp snooping vlan <vlan-id> l2-general-querier-source <source>	Configure the source address of a general query from a layer 2 general querier.
ip igmp snooping vlan <vlan-id> mrouter-port interface <interface -name> no ip igmp snooping vlan <vlan-id> mrouter-port interface <interface -name>	Configure static mrouter port of vlan. The no form of the command cancels this configuration.
ip igmp snooping vlan <vlan-id> mrpt <value> no ip igmp snooping vlan <vlan-id> mrpt	Configure this survive time of mrouter port. The “ no ip igmp snooping vlan <vlan-id> mrpt ” command restores the default value.
ip igmp snooping vlan <vlan-id> query-interval <value> no ip igmp snooping vlan <vlan-id>	Configure this query interval. The “ no ip igmp snooping vlan <vlan-id> query-interval ” command restores the default value.

query-interval	
ip igmp snooping vlan <vlan-id> immediately-leave no ip igmp snooping vlan <vlan-id> immediately-leave	Enable the IGMP fast leave function for the specified VLAN: the “ no ip igmp snooping vlan <vlan-id> immediate-leave ” command disables the IGMP fast leave function.
ip igmp snooping vlan <vlan-id> query-mrsp <value> no ip igmp snooping vlan <vlan-id> query-mrsp	Configure the maximum query response period. The “ no ip igmp snooping vlan <vlan-id> query-mrsp ” command restores to the default value.
ip igmp snooping vlan <vlan-id> query-robustness <value> no ip igmp snooping vlan <vlan-id> query-robustness	Configure the query robustness. The “ no ip igmp snooping vlan <vlan-id> query-robustness ” command restores to the default value.
ip igmp snooping vlan <vlan-id> suppression-query-time <value> no ip igmp snooping vlan <vlan-id> suppression-query-time	Configure the suppression query time. The “ no ip igmp snooping vlan <vlan-id> suppression-query-time ” command restores to the default value.
ip igmp snooping vlan <vlan-id> static-group <A.B.C.D> [source <A.B.C.D>] interface [ethernet port-channel] <IFNAME> no ip igmp snooping vlan <vlan-id> static-group <A.B.C.D> [source <A.B.C.D>] interface [ethernet port-channel] <IFNAME>	Configure static-group on specified port of the VLAN. The no form of the command cancels this configuration.
ip igmp snooping vlan <vlan-id> report source-address <A.B.C.D> no ip igmp snooping vlan <vlan-id> report source-address	Configure forwarding IGMP packet source address, the no operation cancels the packet source address.

43.10.3 IGMP Snooping Examples

Scenario 1: IGMP Snooping function

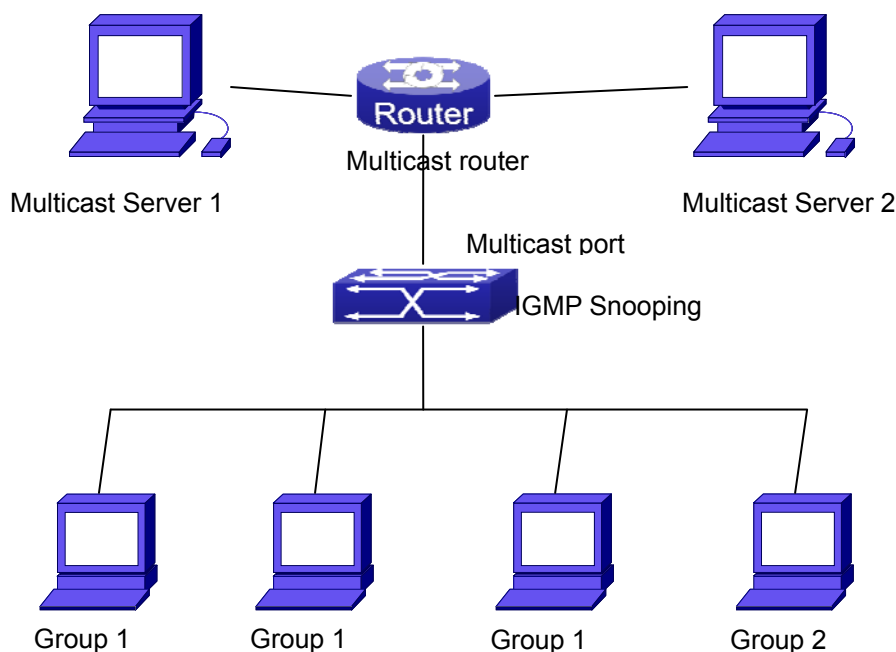

Figure 43-10-1 Enabling IGMP Snooping function

Example: As shown in the above figure, a VLAN 100 is configured in the switch and includes ports 1, 2, 6, 10 and 12. Four hosts are connected to port 2, 6, 10, 12 respectively and the multicast router is connected to port 1. As IGMP Snooping is disabled by default either in the switch or in the VLANs, If IGMP Snooping should be enabled in VLAN 100, the IGMP Snooping should be first enabled for the switch in Global Mode and in VLAN 100 and set port 1 of VLAN 100 to be the mrouter port.

The configuration steps are listed below:

```
XGS3-42000R(config)#ip igmp snooping
XGS3-42000R(config)#ip igmp snooping vlan 100
XGS3-42000R(config)#ip igmp snooping vlan 100 mrouter interface ethernet 1/1
```

Multicast Configuration

Suppose two programs are provided in the Multicast Server using multicast address Group1 and Group2, three of four hosts running multicast applications are connected to port 2, 6, 10 plays program1, while the host is connected to port 12 plays program 2.

IGMP Snooping listening result:

The multicast table built by IGMP Snooping in VLAN 100 indicates ports 1, 2, 6, 10 in Group1 and ports 1, 12 in Group2.

All the four hosts can receive the program of their choice: ports 2, 6, 10 will not receive the traffic of program 2 and port 12 will not receive the traffic of program 1.

Scenario 2: L2-general-querier

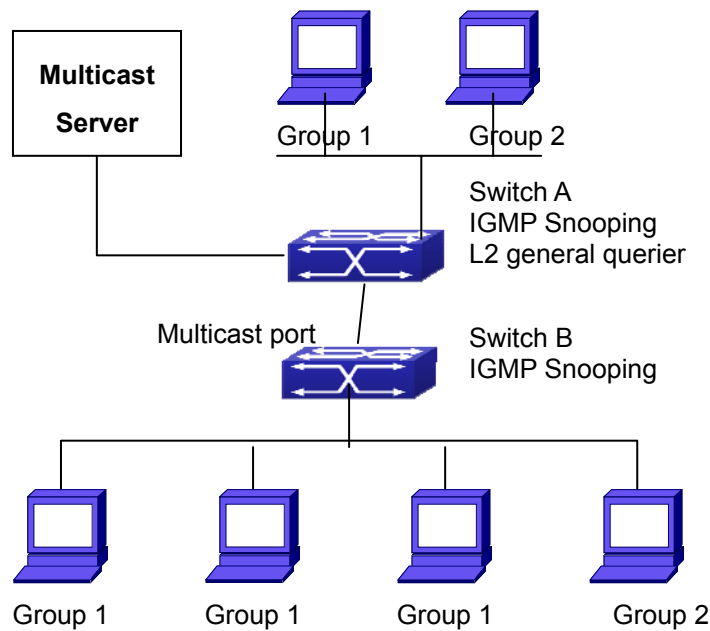

Figure 43-10-1 The switches as IGMP Queries

The configuration of Switch2 is the same as the switch in scenario 1, SwitchA takes the place of Multicast Router in scenario 1. Let's assume VLAN 60 is configured in SwitchA, including ports 1, 2, 6, 10 and 12. Port 1 connects to the multicast server, and port 2 connects to Switch2. In order to send Query at regular interval, IGMP query must enabled in Global mode and in VLAN60.

The configuration steps are listed below:

```
SwitchA#config
SwitchA(config)#ip igmp snooping
SwitchA(config)#ip igmp snooping vlan 60
SwitchA(config)#ip igmp snooping vlan 60 L2-general-querier

SwitchB#config
SwitchB(config)#ip igmp snooping
SwitchB(config)#ip igmp snooping vlan 100
SwitchB(config)#ip igmp snooping vlan 100 mrouter interface ethernet 1/1
```

Multicast Configuration

The same as scenario 1

IGMP Snooping listening result:

Similar to scenario 1

Scenario 3: To run in cooperation with layer 3 multicast protocols.

SWITCH which is used in Scenario 1 is replaced with ROUTER with specific configurations remains the same. And multicast and IGMP snooping configurations are the same with what it is in Scenario 1. To configure PIM-SM on ROUTER, and enable PIM-SM on vlan 100 (use the same PIM mode with the connected multicast router)

Configurations are listed as below:

```
XGS3-42000R#config
XGS3-42000R(config)#ip pim multicast-routing
XGS3-42000R(config)#interface vlan 100
XGS3-42000R(config-if-vlan100)#ip pim sparse-mode
```

IGMP snooping does not distribute entries when layer 3 multicast protocol is enabled. It only does the following tasks.

- Remove the layer 2 multicast entries.
- Provide query functions to the layer 3 with vlan, S, and G as the parameters.
- When layer 3 IGMP is disabled, re-enable distributing layer 2 multicast entries.

By looking up the layer 3 IPMC entries, it can be found that ports can be indicated by the layer 3 multicast entries. This ensures the IGMP snooping can work in cooperation with the layer 3 multicast protocols.

43.10.4 IGMP Snooping Troubleshooting

On IGMP Snooping function configuration and usage, IGMP Snooping might not run properly because of physical connection or configuration mistakes. So the users should note that:

- Make sure correct physical connection
- Activate IGMP Snooping on whole configuration mode (use **ip igmp snooping**)
- Configure IGMP Snooping at VLAN on whole configuration mode (use **ip igmp snooping vlan <vlan-id>**)
- Make sure one VLAN is configured as L2 common checker in same mask, or make sure configured static mrouter
- Use **show ip igmp snooping vlan <vid>** command check IGMP Snooping information

43.11 IGMP Proxy Configuration

43.11.1 Introduction to IGMP Proxy

IGMP/MLD proxy which is introduced in rfc4605, is a simplified multicast protocol running at edge boxes. The edge boxes which runs the IGMP/MLD proxy protocol, does not need to run complicated multicast routing protocols such as PIM/DVMRP. However they work with multicast protocol enabled network through IGMP/MLD proxy. They can simplify the implementation of multicasting on edge devices.

The IGMP/MLD proxy works between the multicast router and the client, it works as both the multicast host and router. Upstream and downstream ports should be specified in the IGMP/MLD proxy configuration. The host protocol runs at upstream ports, while the router protocol runs at downstream ports. The switch collects the join and leave messages received from downstream ports and forward them to the multicast router through upstream ports.

The IGMP proxy configuration is exclusive with PIM and DVMRP configuration.

43.11.2 IGMP Proxy Configuration Task List

- 1 · Enable IGMP Proxy function
- 2 · Enable configurations for both downstream and upstream ports for the IGMP Proxy in different interfaces
- 3 · Configure IGMP Proxy

1. Enable IGMP Proxy function

Command	Explanation
Global Mode	
ip igmp proxy no ip igmp proxy	Enable IGMP Proxy function. The “ no ip igmp proxy ” disables this function.

2. Enable configurations for both downstream and upstream ports for the IGMP Proxy in different interfaces

Command	Explanation
Interface Configuration Mode	
ip igmp proxy upstream no ip igmp proxy upstream	Enable IGMP Proxy upstream function. The “ no ip igmp proxy upstream ” disables this function.
ip igmp proxy downstream no ip igmp proxy downstream	Enable IGMP Proxy downstream function. The “ no ip igmp proxy downstream ” disables this function.

3. Configure IGMP Proxy assistant parameter

Command	Explanation
Global Mode	
ip igmp proxy limit {group <1-500> source <1-500>} no ip igmp proxy limit	To configure the maximum number of groups that upstream ports can join, and the maximum number of sources in a single group. The no form of this command will restore the default value.
ip igmp proxy unsolicited-report interval <1-5> no ip igmp proxy unsolicited-report interval	To configure how often the upstream ports send out unsolicited report. The no form of this command will restore the default configuration.

ip igmp proxy unsolicited-report robustness <2-10> no ip igmp proxy unsolicited-report robustness	To configure the retry times of upstream ports' sending unsolicited reports. The no form of this command will restore the default value.
ip igmp proxy aggregate no ip igmp proxy aggregate	To configure non-query downstream ports to be able to aggregate the IGMP operations. The no form of this command will restore the default configuration.
ip multicast ssm range <1-99> ip multicast ssm default no ip mulitcast ssm	To configure the address range for IGMP proxy ssm multicast groups; The no form of this command will remove the configuration.
ip igmp proxy multicast-source no ip igmp proxy multicast-source	To configure the port as downstream ports for the source of multicast datagram; The no from of this command will disable the configuration.

43.11.3 IGMP Proxy Examples

Example 1: IGMP Proxy function.

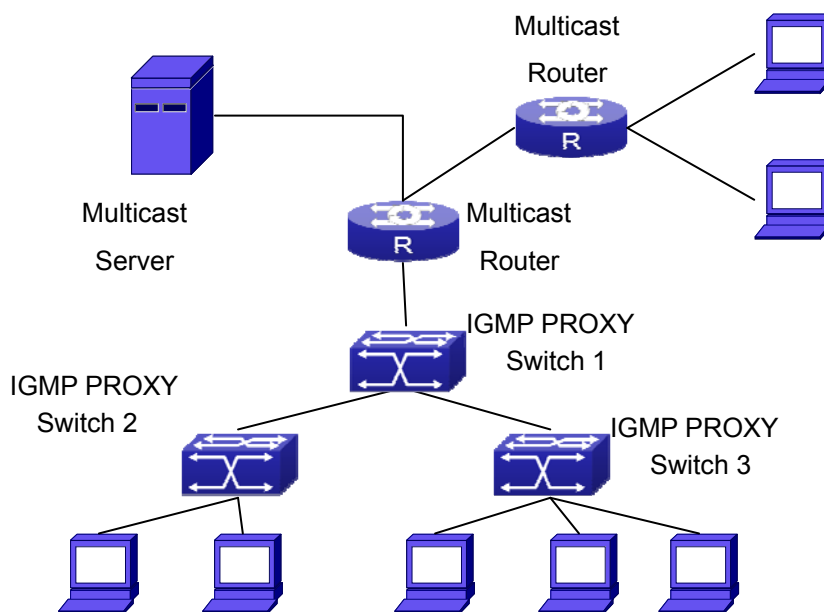

Figure 43-11-1 IGMP Proxy Topology Diagram

As it is show in the figure above, the switch functions as IGMP Proxy in a network of topology of tree, the switch aggregates the multicast dataflow from upstream port and redistributes them to the downstream ports, while the IGMP membership reports flow from downstream ports to upstream ports. Three IGMP Proxy enabled switches which are connected in tree topology, respectively have one port connected to multicast

routers, and no less than one ports connected to hosts or upstream ports from other IGMP Proxy enabled switches.

The configuration steps are listed below:

```
XGS3-42000R#config
XGS3-42000R(config)#ip igmp proxy
XGS3-42000R(config)#interface vlan 1
XGS3-42000R(config-if-Vlan1)#ip igmp proxy upstream
XGS3-42000R(config)#interface vlan 2
XGS3-42000R(config-if-Vlan2)#ip igmp proxy downstream
```

Multicast Configuration:

Suppose the multicast server offers some programs through 224.1.1.1. Some hosts subscribe that program at the edge of the network. The IGMP multicast members report themselves to the downstream ports of IGMP Proxy enabled Switch 2 and Switch 3. Switch 2 and Switch 3 then aggregate the group membership information and send them through the upstream ports. Switch 1 finally forward these membership information to the multicast router when receiving the group membership information through upstream ports, and deliver the multicast dataflow through downstream ports.

Example2: IGMP Proxy for multicast sources from downstream ports.

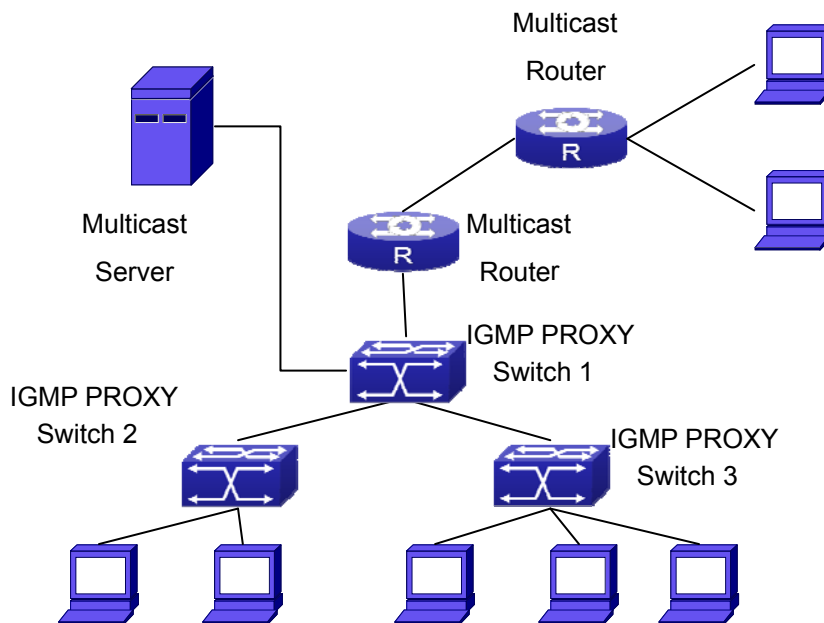

Figure 43-11-2 IGMP Proxy for multicast sources from downstream ports

As it is show in the figure above, IGMP Proxy enabled switches connected to the network in tree topology. The multicast source server connects to the downstream port of Switch1, the multicast dataflow is distributed through the upstream port and other downstream ports. Three IGMP Proxy enabled switches which are connected in tree topology, respectively have one port connected to multicast routers, and no less than one ports connected to hosts or upstream ports from other IGMP proxy enabled switches.

The configuration steps are listed below:

IGMP PROXY Switch1 configuration :

```
XGS3-42000R#config
XGS3-42000R(config)#ip igmp proxy
XGS3-42000R(config)#interface vlan 1
XGS3-42000R(config-if-Vlan1)#ip igmp proxy upstream
XGS3-42000R(config)#interface vlan 2
XGS3-42000R(config-if-Vlan2)#ip igmp proxy downstream
XGS3-42000R(config-if-Vlan2)#ip igmp proxy multicast-source
```

Route1 configuration:

```
XGS3-42000R#config
XGS3-42000R(config)#ip pim multicast
XGS3-42000R(config)#interface vlan 1
XGS3-42000R(config-if-Vlan1)#ip pim sparse-mode
XGS3-42000R(config-if-Vlan1)#ip pim bsr-border
```

Multicast Configuration:

Suppose the server provides programs through the multicast address 224.1.1.1, and some hosts subscribe that program on the edge of the network. The host reports their IGMP multicast group membership to Switch 2 and Switch 3 through downstream ports. Switch 2 and Switch 3 then aggregate and forward them to Switch 1 which then forwards the information to multicast router. When multicast dataflow arrives, the IGMP Proxy enabled switches re-distribute the group membership through upstream ports and downstream ports. When the multicast router receives the multicast dataflow from IGMP proxy, it will consider the multicast data source is directly connected to the router, and determine the identity of DR and ORIGINATOR. The multicast dataflow will be redistributed according to the PIM protocol.

43.11.4 IGMP Proxy Troubleshooting

When IGMP Proxy function configuration and usage, IGMP Proxy might not run properly because of physical connection or configuration mistakes. So the users should note that:

- Make sure physical connection correctly;
- Activate IGMP Proxy on whole Global mode (use **ip igmp proxy**);
- Make sure configure one upstream port and at least one downstream port under interface configuration mode (Use **ip igmp proxy upstream**, **ip igmp proxy downstream**);
- Use **show ip igmp proxy** command to check if the IGMP Proxy information is correct.

If the IGMP Proxy problem remains unsolved, please use debug IGMP Proxy and other debugging command and copy the DEBUG message within three minutes, send the recorded message to the technical service center of our company.

Chapter 44 IPv6 Multicast Protocol

44.1 PIM-DM6

44.1.1 Introduction to PIM-DM6

PIM-DM6 (Protocol Independent Multicast, Dense Mode) is the IPv6 version of Protocol Independent Multicast Dense Mode. It is a Multicast Routing Protocol in dense mode which adapted to small network. The members of multicast group are relatively dense under this kind of network environment. There is no difference compared with the IPv4 version PIM-DM except that the addresses it uses are IPv6 addresses. Thus we don't differentiate between PIM-DM and PIM-DM6 in this chapter. All PIM-DM in the text without specific explanation refers to IPv6 version PIM-DM.

As a result of continuous development of IPv6 network, it has the network environment of nonsupport IPv6 multicast sometimes, so it needs to do the IPv6 multicast operation by tunnel. Therefore, our PIM-DM6 supports configuration on configure tunnel, and passes through nonsupport IPv6 multicast network by single cast packet of IPv4 encapsulation.

The working process of PIM-DM can be summarized as: Neighbor Discovery, Flooding-Prune, and Graft.

1. Neighbor Discovery

When PIM-DM router is started at beginning, Hello message is required to discover neighbors. The network nodes running PIM-DM use Hello message to contact each other. PIM-DM Hello message is sent periodically.

2. Flooding-Prune

PIM-DM assumes that all hosts on the network are ready to receive multicast data. When certain multicast source S begins to send data to a multicast group G, after receiving the multicast packet, the router will make RPF examination first according to the unicast table. If the check passes, the router will create a (S, G) table item and forward the multicast packet to all downstream PIM-DM nodes (Flooding). If the RPF examination fails, i.e. the multicast packet is inputted from the incorrect interface, and then the message is discarded. After this procedure, every node will create an (S, G) item in the PIM-DM multicast domain. If there is no multicast group member in the downstream nodes, then a Prune message is sent to upstream nodes notifying not to forward data to this multicast group any more. After receiving Prune message, the corresponding interfaces will be deleted from the output interface list corresponding with the multicast-forwarding item (S, G). Through this process, a SPT (Shortest Path Tree) is established with source S as root. Prune process is started by a sub-router.

The process above is called Flooding-Prune process. Each pruned node also provides overtime mechanism at the same time. In case of overtime of prune, the router will restart flooding-prune process. Flooding-prune of PIM-DM is conducted periodically

3. RPF examination

Adopting RPF examination, PIM-DM establishes a multicast forwarding tree initiating from data source, using existing unicast routing table. When a multicast packet arrives, the router will determine the correctness of its coming path first. If the arrival interface is the interface connected to multicast source indicated by unicast routing, then this multicast packet is considered to be from the correct path; otherwise

the multicast packet will be discarded as redundant message. The unicast routing message used as path judgment can root in any Unicast Routing Protocol, such as messages found by RIP, OSPF, etc. It doesn't rely on any specific unicast routing protocol.

4. Assert Mechanism

If two multicast router A and B in the same LAN segment have their own receiving paths to multicast source S, they will respectively forward multicast data packet to LAN after receiving the packet from multicast source S. Then downstream nodes multicast router C will receive two multicast packets that are exactly the same. Once router detects such circumstance, a unique forwarder will be selected through "assert" mechanism. The optimized forwarding path is selected through "assert" packet. If the priority and costs of two or more than two paths are same, the node with a larger IP address will be selected as the upstream neighbor of item (S, G), which will be responsible for forwarding the (S, G) multicast packet.

5. Graft

When the pruned downstream node needs to recover to forwarding status, this node uses Graft Message to notify upstream nodes to resume multicast data forwarding.

44.1.2 PIM-DM6 Configuration Task List

- 1 · Enable PIM-DM (Required)
- 2 · Configure static multicast routing entries (Optional)
- 3 · Configure additional PIM-DM parameters (Optional)
 - (1) Configure parameters for PIM-DM interfaces
 - 1) Configure the interval for PIM-DM hello messages
 - 2) Configure the interval for PIM-DM state-refresh messages
 - 3) Configure the boundary interfaces
 - 4) Configure the management boundary
- 4 · Disable PIM-DM protocol

1. Enable the PIM-DM protocol

On XGS3 series switches, PIM-DM can be enabled through two steps. Firstly PIM multicast routing should be enabled in global configuration mode, then PIM-DM should be configured for the specific interfaces.

Command	Explanation
Command configuration mode	
ipv6 pim multicast-routing	To enable PIM-DM multicast routing global. However, in order to enable PIM-DM for specific interfaces, the following command must be issued.

Enable PIM-SM for the specific interface:

Command	Explanation
Interface configuration mode	
ipv6 pim dense-mode	To enable PIM-DM for the specified interface (required).

2 · Configure static multicast routing entries

Command	Explanation
Global configuration mode	
ipv6 mroute <X:X::X:X> <X:X::X:X> <ifname> <.ifname> no ipv6 mroute <X:X::X:X> <X:X::X:X> [<ifname> <.ifname>]	To configure IPv6 static multicast routing entries. The no form of this command will remove the specified routing entry.

3. Configure additional PIM-DM parameters

(1) Configure parameters for PIM-DM interfaces

1) Configure the interval for PIM-DM hello messages

Command	Explanation
Interface Configuration Mode	
ipv6 pim hello-interval <interval> no ipv6 pim hello-interval	To configure the interval for PIM-DM hello messages. The no form of this command will restore the default value.

2) Configure the interval for PIM-DM state-refresh messages

Command	Explanation
Interface Configuration Mode	
ipv6 pim state-refresh origination-interval no ipv6 pim state-refresh origination-interval	To configure the interval for sending PIM-DM state-refresh packets. The no form of this command will restore the default value.

3) Configure the boundary interfaces

Command	Explanation
Interface Configuration Mode	
ipv6 pim bsr-border no ipv6 pim bsr-border	To configure the interface as the boundary of PIM-DM6 protocol. On the boundary interface, STATE REFRESH messages will not be sent or received. The network connected the interface is considered as directly connected network. The no form of this command will remove the configuration.

4) Configure the management boundary

Command	Explanation
Interface Configuration Mode	
ipv6 pim scope-border <500-599> <acl_name> no ipv6 pim scope-border	To configure PIM-DM6 management boundary for the interface and apply ACL for the management boundary. With default settings, ff0::/13 is considered as the scope of the management group. If ACL is configured, then the scope specified by ACL permit command is the scope of the management group. acl_name should be standard IPv6 ACL name. The no form of this command will remove the configuration.

4. Disable PIM-DM protocol

Command	Notes
Interface Configuration Mode	
no ipv6 pim dense-mode	To disable PIM-DM for the specified interface.
Global Configuration Mode	
no ipv6 pim multicast-routing	To disable PIM-DM globally.

44.1.3 PIM-DM6 Typical Application

As shown in the following figure, add the Ethernet interfaces of Switch A and Switch B to corresponding vlan, and start PIM-DM Protocol on each vlan interface.

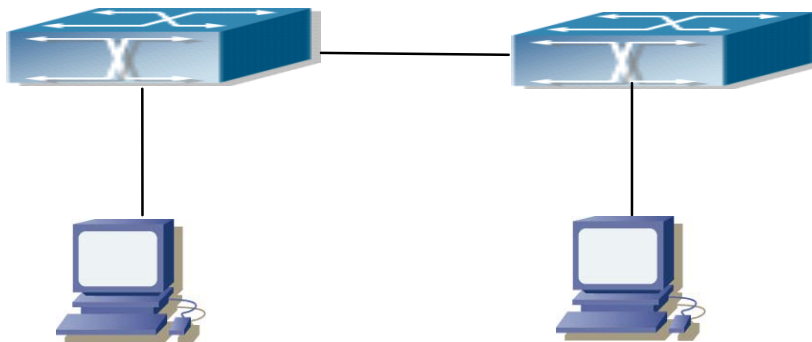

Figure 44-1-1 PIM-DM Typical Environment

The configuration procedure for SwitchA and SwitchB is as below:

(1) Configure SwitchA:

```
XGS3-42000R(config)#ipv6 pim multicast-routing
XGS3-42000R(config)#interface vlan 1
XGS3-42000R(config-if-Vlan1)#ipv6 address 2000:10:1:1::1/64
XGS3-42000R(config-if-Vlan1)#ipv6 pim dense-mode
XGS3-42000R(config-if-Vlan1)#exit
XGS3-42000R(config)#interface vlan2
XGS3-42000R(config-if-Vlan2)#ipv6 address 2000:12:1:1:: 1/64
XGS3-42000R(config-if-Vlan2)#ipv6 pim dense-mode
```

(2) Configure SwitchB:

```
XGS3-42000R(config)#ip pim multicast-routing
XGS3-42000R(config)#interface vlan 1
XGS3-42000R(config-if-Vlan1)#ipv6 address 2000:12:1:1::2/64
XGS3-42000R(config-if-Vlan1)#ipv6 pim dense-mode
XGS3-42000R(config-if-Vlan1)#exit
XGS3-42000R(config)#interface vlan 2
XGS3-42000R(config-if-Vlan2)#ipv6 address 2000:20:1:1::1/64
XGS3-42000R(config-if-Vlan2)#ipv6 pim dense-mode
```

44.1.4 PIM-DM6 Troubleshooting

When configuring and using PIM-DM protocol, PIM-DM protocol may fail to work normally due to physical connections, incorrect configuration and so on. So, users shall note the following points:

- Assure the physical connection is correct.
- Assure the Protocol of Interface and Link is UP (use show interface command);
- Assure PIM Protocol is turned on in Global Mode (use ipv6 pim multicast-routing command)
- Start PIM-DM Protocol on the interface (use ipv6 pim dense-mode command)

Unicast route shall be used to carry out RPF examination for multicast protocol. So the correctness of unicast route shall be guaranteed above all. If all attempts fail to solve the problems on PIM-DM, then use debug commands such as debug ipv6 pim, copy DEBUG information in 3 minutes and send to Technology Service Center.

44.2 PIM-SM6

44.2.1 Introduction to PIM-SM6

PIM-SM6 (Protocol Independent Multicast, Sparse Mode) is the IPv6 version of Protocol Independent Multicast Sparse Mode. It is a multicast routing protocol in sparse mode and mainly used in large network with group members distributed relatively sparse and wide. It is no difference from the IPv4 version PIM-SM except the addresses it uses are IPv6 addresses. Thus we don't differentiate between PIM-SM and PIM-SM6 in this chapter. All PIM-SM in the text without specific explanation is IPv6 version PIM-SM. Unlike the Flooding-Prune of Dense Mode, PIM-SM Protocol assumes no host needs receiving multicast data packets. PIM-SM router forwards multicast data packets to a host only on definite request.

By setting RP (Rendezvous Point) and BSR (Bootstrap Router), PIM-SM announce multicast packet to all PIM-SM routers and establish, using Join/Prune message of routers, RPT (RP-rooted shared tree) based on RP. Consequently the network bandwidth occupied by data packets and control messages is cut down and the transaction cost of routers is reduced. Multicast data get to the network segment where the multicast group members are located along the shared tree flow. When the data traffic reaches a certain amount, multicast data stream can be switched to source-based SPT (Shortest Path Tree) to shorten network delay. PIM-SM doesn't rely on any specific unicast routing protocol but make RPF examination using existing unicast routing table.

1. PIM-SM Working Principle

The working process of PIM-SM mainly includes neighbor discovery, creation of RPT, registration of multicast source, SPT switch and so on. The neighbor discovery mechanism is the same with the mechanism of PIM-DM. We won't introduce any more.

(1) Creation of RP Shared Tree (RPT)

When a host joins a multicast group G, the leaf router directly connected with the host finds out through IGMP message that there is a receiver of multicast group G, then it works out the corresponding Rendezvous Point RP for multicast group G, and send join message to upper level nodes in RP direction. Every router on the way from the leaf router to RP will create a (*, G) table item, indicating the message from any source to multicast group G is suitable for this item. When RP receives the message sent to multicast group G, the message will get to the leaf router along the established path and then reach the host. In this way, the RPT with RP as root is created.

(2) Multicast Source Registration

When multicast source S sends a multicast packet to multicast group G, the PIM-SM multicast router directly connected to it will take charge of sealing the multicast packet into registered message and unicast it to corresponding RP. If there are more than one PIM-SM multicast routers on a network segment, then DR (Designated Router) takes charge of forwarding the multicast packet.

(3) SPT Switch

Once the multicast router finds that the rate of the multicast packet from RP with destination address G exceeds threshold, the multicast router will send Join message to the upper level nodes in the source direction, which results in the switch from RPT to SPT.

2. Preparation before PIM-SM configuration

(1) Configuration Candidate RP

More than one RPs (candidate RP) are permitted in PIM-SM network and each C-RP (Candidate RP) takes charge of forwarding multicast packets with destination address in a certain range. To configure more than one candidate RPs can achieve RP load balancing. There is no master or slave difference among RPs. All multicast routers work out the RP corresponded with certain multicast group based on the same algorithm after receiving the candidate RP message announced by BSR.

Note that one RP can serve more than one multicast groups, even all multicast groups. But each multicast group can only correspond with one unique RP at any moment. It can't correspond with more RPs at the same time.

(2) BSR Configuration

As the management core of PIMSM network, BSR is in charge of collecting messages sent by candidate RPs and broadcast them..

There may be only one BSR within a network. However, there may be several candidate BSRs to be configured. With such arrangement, once a BSR fails, another may be switched to. C-BSR determines BSR through automatic selection.

44.2.2 PIM-SM6 Configuration Task List

- 1 · Enable PIM-SM (Required)
- 2 · Configure static multicast routing entries (Optional)
- 3 · Configure additional parameters for PIM-SM (Optional)
- (1) Configure parameters for PIM-SM interfaces
 - 1) Configure the interval for PIM-SM hello messages
 - 2) Configure the holdtime for PIM-SM hello messages
 - 3) Configure ACL for PIM-SM6 neighbors
 - 4) Configure the interface as the boundary interface of the PIM-SM6 protocol
 - 5) Configure the interface as the management boundary of the PIM-SM6 protocol
- (2) Configure global PIM-SM parameters
 - 1) Configure the switch as a candidate BSR
 - 2) Configure the switch as a candidate RP
 - 3) Configure static RP
- 4 · Disable the PIM-SM protocol

1. Enable PIM-SM protocol

The PIM-SM protocol can be enabled on XGS3 series Layer 3 switches by enabling PIM6 in global configuration mode and then enabling PIM-SM for specific interfaces in the interface configuration mode.

Command	Explanation
Global Configuration Mode	
[no] ipv6 pim multicast-routing	To enable the PIM-SM6 protocol for all the interfaces (However, in order to make PIM-SM work for specific interfaces, the following command should be issued). (required)

Make the PIM-SM protocol work for specific interfaces

Command	Explanation
Interface Configuration Mode	
[no] ipv6 pim sparse-mode [passive]	To enable PIM-SM for the specified interface. The no form of this command will disable the PIM-SM protocol (required).

2 · Configure static multicast routing entries

Command	Explanation
Global Configuration Mode	
ipv6 mroute <X:X::X:X> <X:X::X:X> <ifname> <.ifname> no ipv6 mroute <X:X::X:X> <X:X::X:X> [<ifname> <.ifname>]	To configure a static multicast routing entry. The no form of this command will remove the specified static multicast routing entry.

3. Configure the additional parameters for PIM-SM

(1) Configure parameters for PIM-SM interfaces

1) Configure the interval for PIM-SM hello messages

Command	Explanation
Interface Configuration Mode	
ipv6 pim hello-interval <interval> no ipv6 pim hello-interval	To configure the interval for PIM-SM hello messages. The no form of this command restores the interval to the default value.

2) Configure the hold time for PIM-SM6 hello messages

Command	Explanation
Interface Configuration Mode	
ipv6 pim hello-holdtime <value> no ipv6 pim hello-holdtime	To configure the value of the holdtime field in the PIM-SM hello messages. The no form of this command will restore the hold time to the default value.

3) Configure ACL for PIM-SM6 neighbors

Command	Explanation
Interface Configuration Mode	
ipv6 pim neighbor-filter <access-list-name> no ipv6 pim neighbor-filter <access-list-name>	To configure ACL to filter PIM-SM6 neighbor. If session to the neighbor has been denied by ACL, then the sessions that have been set up will be discarded immediately and new sessions will not be set up.

4) Configure the interface as the boundary interface of the PIM-SM6 protocol

Command	Explanation
Interface Configuration Mode	
ipv6 pim bsr-border no ipv6 pim bsr-border	To configure the interface as the boundary of PIM-SM6 protocol. On the boundary interface, BSR messages will not be sent or received. The network connected the interface is considered as directly connected network. The no form of this command will remove the configuration.

5) Configure the interface as the management boundary of the PIM-SM6 protocol

Command	Explanation
Interface Configuration Mode	
ipv6 pim scope-border <500-599> <acl_name> no ipv6 pim scope-border	To configure PIM-SM6 management boundary for the interface and apply ACL for the management boundary. With default settings, ff00::/13 is considered as the scope of the management group. If ACL is configured, then the scope specified by ACL permit command is the scope of the management group. acl_name should be standard IPv6 ACL name. The no form of this command will remove the configuration.

(2) Configure global PIM-SM6 parameter

1) Configure the switch as a candidate BSR

Command	Explanation
Global Configuration Mode	
ipv6 pim bsr-candidate {vlan <vlan_id> <ifname> tunnel <1-50>}[hash-mask-length] [priority] no ipv6 pim bsr-candidate {vlan <vlan_id> <ifname> tunnel <1-50>}[hash-mask-length] [priority]	This command is the global candidate BSR configuration command, which is used to configure the information of PIM-SM candidate BSR so that it can compete for BSR router with other candidate BSR. The no operation is to cancel the configuration of BSR.

2) Configure the switch as a candidate RP

Command	Explanation
Global Configuration Mode	
ipv6 pim rp-candidate {vlan<vlan-id> loopback<index> <ifname>} [<group range>] [<priority>] no ipv6 pim rp-candidate	This command is the global candidate RP configuration command, which is used to configure the information of PIM-SM candidate RP so that it can compete for RP router with other candidate RP. The no operation is to cancel the configuration of RP.

3) Configure static RP

Command	Explanation
Global Configuration Mode	
ipv6 pim rp-address <rp-address> [<group-range>] no ipv6 pim rp-address <rp-address> {all <group-range>}	To configure the address of the candidate RP. The no form of this command will remove the configuration for the candidate RP.

4. Disable PIM-SM protocol

Command	Explanation
Interface Configuration Mode	
no ipv6 pim sparse-mode	To disable the PIM-SM6 protocol.
Global Configuration Mode	
no ipv6 pim sparse-mode	To disable PIM-DM globally.

44.2.3 PIM-SM6 Typical Application

As shown in the following figure, add the Ethernet interfaces of SwitchA, SwitchB, SwitchC and SwitchD to corresponding VLAN, and start PIM-SM Protocol on each VLAN interface.

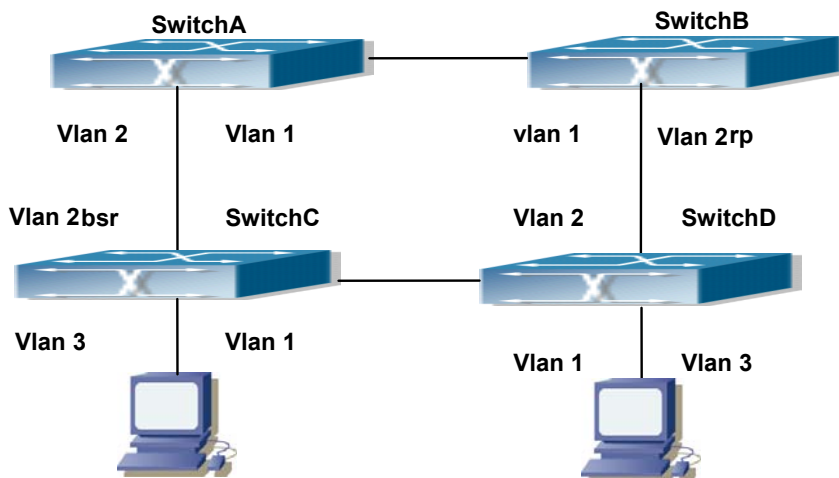

Figure 44-2-1 PIM-SM Typical Environment

The configuration procedure for SwitchA, SwitchB, SwitchC and SwitchD is as below:

(1) Configure SwitchA:

```
XGS3-42000R(config)#ipv6 pim multicast-routing
XGS3-42000R(config)#interface vlan 1
XGS3-42000R(config-if-Vlan1)#ipv6 address 2000:12:1:1::1/64
XGS3-42000R(config-if-Vlan1)#ipv6 pim sparse-mode
XGS3-42000R(config-if-Vlan1)#exit
XGS3-42000R(config)#interface vlan 2
XGS3-42000R(config-if-Vlan2)#ipv6 address 2000:13:1:1::1/64
XGS3-42000R(config-if-Vlan2)#ipv6 pim sparse-mode
```

(2) Configure Switch B:

```
XGS3-42000R(config)#ipv6 pim multicast-routing
XGS3-42000R(config)#interface vlan 1
XGS3-42000R(config-if-Vlan1)#ipv6 address 2000:12:1:1::2/64
XGS3-42000R(config-if-Vlan1)#ipv6 pim sparse-mode
XGS3-42000R(config-if-Vlan1)#exit
XGS3-42000R(config)#interface vlan 2
XGS3-42000R(config-if-Vlan2)#ipv6 address2000:24:1:1::2/64
XGS3-42000R(config-if-Vlan2)#ipv6 pim sparse-mode
XGS3-42000R(config-if-Vlan2)#exit
XGS3-42000R(config)#ipv6 pim rp-candidate vlan2
```

(3) Configure SwitchC:

```
XGS3-42000R(config)#ipv6 pim multicast-routing
XGS3-42000R(config)#interface vlan 1
XGS3-42000R(config-if-Vlan1)#ipv6 address 2000:34:1:1::3/64
XGS3-42000R(config-if-Vlan1)#ipv6 pim sparse-mode
XGS3-42000R(config-if-Vlan1)#exit
XGS3-42000R(config)#interface vlan 2
XGS3-42000R(config-if-Vlan2)#ipv6 address 2000:13:1:1::3/64
XGS3-42000R(config-if-Vlan2)#ipv6 pim sparse-mode
XGS3-42000R(config-if-Vlan2)#exit
XGS3-42000R(config)#interface vlan 3
XGS3-42000R(config-if-Vlan3)#ipv6 address 2000:30:1:1::1/64
XGS3-42000R(config-if-Vlan3)#ipv6 pim sparse-mode
XGS3-42000R(config-if-Vlan3)#exit
XGS3-42000R(config)#ipv6 pim bsr-candidate vlan2 30 10
```

(4) Configure SwitchD:

```
XGS3-42000R(config)#ipv6 pim multicast-routing
XGS3-42000R(config)#interface vlan 1
XGS3-42000R(config-if-Vlan1)#ipv6 address 2000:34:1:1::4/64
XGS3-42000R(config-if-Vlan1)#ipv6 pim sparse-mode
XGS3-42000R(config-if-Vlan1)#exit
XGS3-42000R(config)#interface vlan 2
XGS3-42000R(config-if-Vlan2)#ipv6 address 2000:24:1:1::4/64
XGS3-42000R(config-if-Vlan2)#ipv6 pim sparse-mode
XGS3-42000R(config-if-Vlan2)#exit
XGS3-42000R(config)#interface vlan 3
XGS3-42000R(config-if-Vlan3)#ipv6 address 2000:40:1:1::1/64
XGS3-42000R(config-if-Vlan3)#ipv6 pim sparse-mode
```

44.2.4 PIM-SM6 Troubleshooting

When configuring and using PIM-SM protocol, PIM-SM protocol may fail to work normally due to physical connections, incorrect configuration and so on. So, users shall note the following points:

- Assure the physical connection is correct.
- Assure the Protocol of Interface and Link is UP (use show interface command);
- Unicast route shall be used to carry out RPF examination for multicast protocol. So the correctness of unicast route shall be guaranteed above all.
- PIM-SM Protocol requires supports of RP and BSR, therefore you should use show ipv6 pim bsr-router first to see if there is BSR information. If not, you need to check if there is unicast routing leading to BSR.
- Use show ipv6 pim rp-hash command to check if RP information is correct; if there is no RP information, you still need to check unicast routing;

If all attempts fail to solve the problems on PIM-SM, then use debug commands such as debug ipv6 pim/ debug ipv6 pim bsr, copy DEBUG information in 3 minutes and send to Technology Service Center.

44.3 ANYCAST RP v6 Configuration

44.3.1 Introduction to ANYCAST RP v6

Anycast RP v6 is a technology based on PIM protocol, which provides redundancy in order to recover as soon as possible once an RP becomes unusable.

The kernel concept of Anycast RP v6 is that the RP addresses configured all over the whole network exist on multiple multicast servers (the most common situation is that every device providing ANYCAST RP uses LOOPBACK interface, and using the longest mask to configures RP addresses on this interface), while the unicast routing algorithm will make sure that PIM routers can always find the nearest RP, thus , providing a

shorter and faster way to find RP in a larger network., Once an RP being used becomes unusable, the unicast routing algorithm will ensure that the PIM router can find a new RP path fast enough to recover the multicast server in time. Multiple RP will cause a new problem that is if the multicast source and the receivers are registered to different RP, some receivers will not be able to receive data of multicast source (obviously, the register messages only prefer the nearest RP). So, in order to keep the communication between all RP, Anycast RP defines that the nearest RP to the multicast source should forward the source register messages to all the other RP to guarantee that all joiners of the RP can find the multicast source.

The method to realize the PIM-protocol-based Anycast RP is that: maintaining an ANYCAST RP list on every switch configured with Anycast RP and using another address as the label to identify each other. When one Anycast RP device receives a register message, it will send the register message to other Anycast RP devices while using its own address as the source address, to notify all the other devices of the original destination.

44.3.2 ANYCAST RP v6 Configuration Task

1. Enable ANYCAST RP v6 function
2. Configure ANYCAST RP v6

1. Enable ANYCAST RP v6 function

Command	Explanation
Global Configuration Mode	
ipv6 pim anycast-rp no ipv6 pim anycast-rp	Enable ANYCAST RP function. (necessary) The no operation will globally disable the ANYCAST RP function.

2. Configure ANYCAST RP v6

(1) Configure RP candidate

Command	Explanation
Global Configuration Mode	
ipv6 pim rp-candidate {vlan<vlan-id> loopback<index> <ifname>} [<A::B::C:D>][<priority>] no ipv6 pim rp-candidate	Now, the PIM-SM has allowed the Loopback interface to be a RP candidate.(necessary) Please pay attention to that, ANYCAST RP protocol can configure the Loopback interface or a regular three-layer VLAN interface to be the RP candidate. In make sure that PIM routers in the network can find where the RP locates, the RP candidate interface should be added into the router. No operation will cancel the RP candidate configured on this router.

(2) Configure self-rp-address (the RP communication address of this router)

Command	Explanation
Global Configuration Mode	
<pre> ipv6 pim anycast-rp self-rp-address A:B::C:D no ipv6 pim anycast-rp self-rp-address </pre>	<p>Configure the self-rp-address of this router (as a RP). This address can be used to exclusively identify this router when communicating with other RP.(necessary)</p> <p>the effect of self-rp-address refers to two respects:</p> <p>1 Once this router (as a RP) receives the register message from a DR unicast, it needs to forward the register message to all the other RP in the network, notifying them of the state of source (S.G). While forwarding the register message, this router will change the source address of it into self-rp-address.</p> <p>2 Once this router(as a RP) receives a register message from other RP unicast, such as a register message whose destination is the self-rp-address of this router, it will create (S,G) state and send back a register-terminating message, whose destination address is the source address of the register message.</p> <p>Pay attention: self-rp-address has to be the address of a three-layer interface on this router, but the configuration is allowed to be done with the absence of the interface. The self-rp-address should be unique.</p> <p>No operation will cancel the self-rp-address which is used to communicate with other RP by this router.</p>

(3) Configure other-rp-address (other RP communication addresses)

Command	Explanation
Global Configuration Mode	
<pre> ipv6 pim anycast-rp <anycast-rp-addr> <other-rp-addr> no ipv6 pim anycast-rp <anycast-rp-addr> <other-rp-addr> </pre>	<p>Configure anycast-rp-addr on this router (as a RP). This unicast address is actually the RP address configured on multiple RP in the network, in accordance with the address of RP candidate interface (or Loopback interface).</p> <p>The effect of anycast-rp-addr includes:</p> <p>1 Although more than one anycast-rp-addr addresses are allowed to be configured, only the one having the same address with the currently configured RP candidate address will take effect.</p>

Only after that, can the other-rp-address in accordance with this anycast-rp-addr take effect.

2 The configuration is allowed to be done with the absence of the interface in accordance with the anycast-rp-addr. Configure on this router (as a RP) the other-rp-addresses of other RP communicating with it. This unicast address identifies other RP and is used in the communication with local routers. The effect of **other-rp-address** refers to two respects:

1 Once this router (as a RP) receives the register message from a DR unicast, it should forward it to other RP in the network to notify all the RP in the network of the source (S.G) state. While forwarding, the router will change the destination address of the register message into other-rp-address.

2 Multiple other-rp-addresses can be configured in accordance with one anycast-rp-addr, Once the register message from a DR is received, it should be forwarded to all of this RP one by one.

No operation will cancel other-rp-address communicating with this router.

44.3.3 ANYCAST RP v6 Configuration Examples

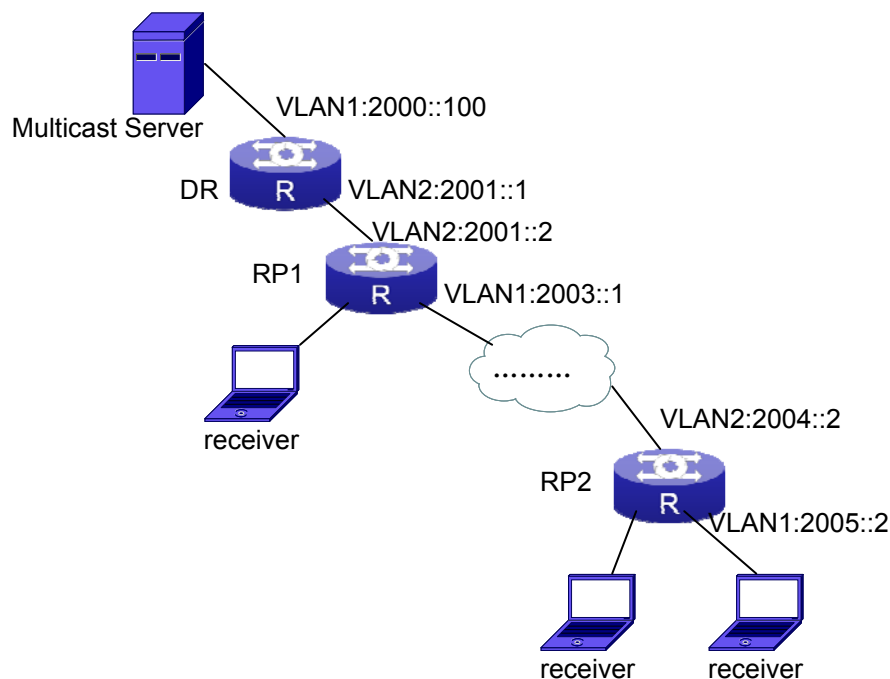

Figure 44-3-1 The ANYCAST RP v6 function of a router

The following is the configuration steps:

RP1 Configuration:

```
XGS3-42000R#config
XGS3-42000R(config)#interface loopback 1
XGS3-42000R(config-if-Loopback1)#ipv6 address 2006::1/128
XGS3-42000R(config-if-Loopback1)#exit
XGS3-42000R(config)#ipv6 pim rp-candidate loopback1
XGS3-42000R(config)#ipv6 pim bsr-candidate vlan 1
XGS3-42000R(config)#ipv6 pim multicast-routing
XGS3-42000R(config)#ipv6 pim anycast-rp
XGS3-42000R(config)#ipv6 pim anycast-rp self-rp-address 2003::1
XGS3-42000R(config)#ipv6 pim anycast-rp 2006::1 2004::2
```

RP2 Configuration:

```
XGS3-42000R#config
XGS3-42000R(config)#interface loopback 1
XGS3-42000R(config-if-Loopback1)#ipv6 address 2006::1/128
XGS3-42000R(config-if-Loopback1)#exit
XGS3-42000R(config)#ipv6 pim rp-candidate loopback1
XGS3-42000R(config)#ipv6 pim multicast-routing
XGS3-42000R(config)#ipv6 pim anycast-rp
XGS3-42000R(config)#ipv6 pim anycast-rp self-rp-address 2004::2
XGS3-42000R(config)#ipv6 pim anycast-rp 2006::1 2003::1
```

Please pay attention to that, for promulgating loopback interface router, if use MBGP4+ protocol, then can use network command; or use RIPng protocol, then can use route command.

44.3.4 ANYCAST RP v6 Troubleshooting

When configuring and using ANYCAST RP v6 function, the ANYCAST RP might work abnormally because of faults in physical connections, configurations or something others. So, the users should pay attention to the following points:

- The physical connections should be guaranteed to be correct
- The PIM-SM6 protocol should be guaranteed to operate normally
- The ANYCAST RP should be guaranteed to be enabled in Global configuration mode
- The self-rp-address should be guaranteed to be configured correctly in Global configuration mode
- The other-rp-address should be guaranteed to be configured correctly in Global configuration mode
- All the interface routers should be guaranteed to be correctly added, including the loopback interface as a RP
- Use “**show ipv6 pim anycast rp status**” command to check whether the configuration information of ANYCAST RP is correct

If the problems of ANYCAST still cannot be solved after checking, please use debug commands like “debug ipv6 pim anycast-rp”, then copy the DEBUG information within three minutes and send it to the technical service center of our company.

44.4 PIM-SSM6

44.4.1 Introduction to PIM-SSM6

Source Specific Multicast (PIM-SSM6) is a new kind of multicast service protocol. With PIM-SSM6, a multicast session is distinguished by the multicast group address and multicast source address. In SSM6, hosts can be added into the multicast group manually and efficiently like the traditional PIM-SM6, but leave out the shared tree and RP management in PIM-S6M. In SSM6, SPT tree will be constructed with (S,G). G for the multicast group address and S for the source address of the multicast which sends datagram to G. (S,G) in a pair is named as a channel of SSM6. SSM6 serves best for the application of multicast service which is from one station to many ones, for example, the network sports video channel, and the news channel. By default, the multicast group address of SSM6 is limited to ff3x::/32. However this address range can be extended according to actual situations.

PIM-SSM6 can be supported in the PIM-DM6 environment.

44.4.2 PIM-SSM6 Configuration Task List

Command	Explanation
Global configuration mode	
ipv6 pim ssm {default range <access-list-number>} no ipv6 pim ssm	To configure address range for pim-ssm multicast group. The no prefix will disable this command.

44.4.3 PIM-SSM6 Configuration Example

As it is shown in the below figure, ethernet interfaces of switchA, switchB, switchC, and switchD are separated into different vlan. And PIM-SM6 or PIM-DM6 is enabled on all the vlan interfaces. Take configuration of PIM-SM6 for example.

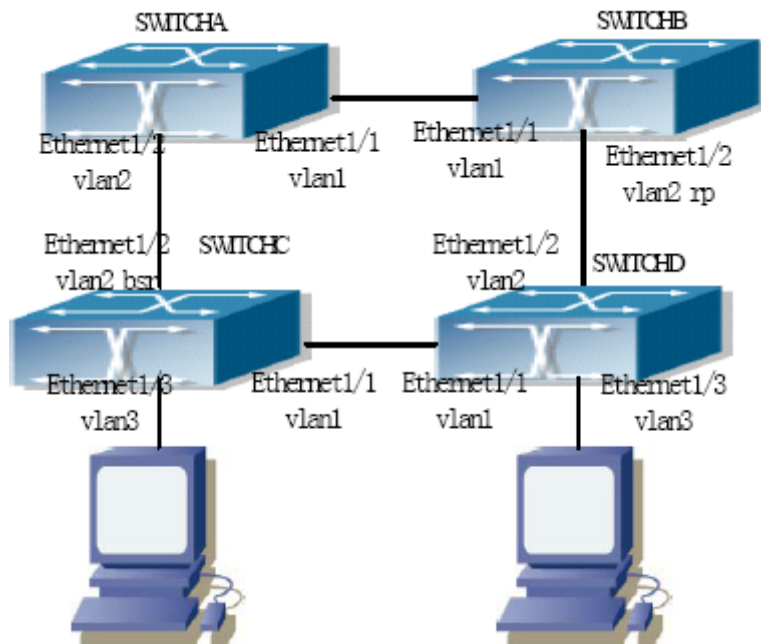

Figure 44-4-1 PIM-SSM typical environment

Configurations of switchA , switchB, switchC and switchD are listed as below:

(1) Configuration of switchA :

```
XGS3-42000R(config)#ipv6 pim multicast-routing
XGS3-42000R(config)#interface vlan 1
XGS3-42000R(config-if-Vlan1)# ipv6 address 2000:12:1:1::1/64
XGS3-42000R(config-if-Vlan1)# ipv6 pim sparse-mode
XGS3-42000R(config-if-Vlan1)#exit
XGS3-42000R(config)#interface vlan 2
XGS3-42000R(config-if-Vlan2)# ipv6 address 2000:13:1:1::1/64
XGS3-42000R(config-if-Vlan2)# ipv6 pim sparse-mode
XGS3-42000R(config-if-Vlan2)#exit
XGS3-42000R(config)#ipv6 access-list 500 permit ff1e::1/64
XGS3-42000R(config)#ip pim ssm range 500
```

(2) Configuration of switchB :

```
XGS3-42000R(config)#ipv6 pim multicast-routing
XGS3-42000R(config)#interface vlan 1
XGS3-42000R(config-if-Vlan1)# ipv6 address 2000:12:1:1::2/64
XGS3-42000R(config-if-Vlan1)# ipv6 pim sparse-mode
XGS3-42000R(config-if-Vlan1)#exit
XGS3-42000R(config)#interface vlan 2
XGS3-42000R(config-if-Vlan2)# ipv6 address2000:24:1:1::2/64
XGS3-42000R(config-if-Vlan2)# ipv6 pim sparse-mode
XGS3-42000R(config-if-Vlan2)# exit
```

```
XGS3-42000R(config)# ipv6 pim rp-candidate vlan2
XGS3-42000R(config)#ipv6 access-list 500 permit ff1e::1/64
XGS3-42000R(config)#ip pim ssm range 500
```

(3) Configuration of SwitchC :

```
XGS3-42000R(config)#ipv6 pim multicast-routing
XGS3-42000R(config)#interface vlan 1
XGS3-42000R(config-lf-Vlan1)# ipv6 address 2000:34:1:1::3/64
XGS3-42000R(config-lf-Vlan1)# ipv6 pim sparse-mode
XGS3-42000R(config-lf-Vlan1)#exit
XGS3-42000R(config)#interface vlan 2
XGS3-42000R(config-lf-Vlan2)# ipv6 address 2000:13:1:1::3/64
XGS3-42000R(config-lf-Vlan2)# ipv6 pim sparse-mode
XGS3-42000R(config-lf-Vlan2)#exit
XGS3-42000R(config)#interface vlan 3
XGS3-42000R(config-lf-Vlan3)# ipv6 address 2000:30:1:1::1/64
XGS3-42000R(config-lf-Vlan3)# ipv6 pim sparse-mode
XGS3-42000R(config-lf-Vlan3)# exit
XGS3-42000R(config)# ipv6 pim bsr-candidate vlan2 30 10
XGS3-42000R(config)#ipv6 access-list 500 permit ff1e::1/64
XGS3-42000R(config)#ip pim ssm range 500
```

(4) Configuration of SwitchD :

```
XGS3-42000R(config)#ipv6 pim multicast-routing
XGS3-42000R(config)#interface vlan 1
XGS3-42000R(config-lf-Vlan1)# ipv6 address 2000:34:1:1::4/64
XGS3-42000R(config-lf-Vlan1)# ipv6 pim sparse-mode
XGS3-42000R(config-lf-Vlan1)#exit
XGS3-42000R(config)#interface vlan 2
XGS3-42000R(config-lf-Vlan2)# ipv6 address 2000:24:1:1::4/64
XGS3-42000R(config-lf-Vlan2)# ipv6 pim sparse-mode
XGS3-42000R(config-lf-Vlan2)#exit
XGS3-42000R(config)#interface vlan 3
XGS3-42000R(config-lf-Vlan3)# ipv6 address 2000:40:1:1::1/64
XGS3-42000R(config-lf-Vlan3)# ipv6 pim sparse-mode
XGS3-42000R(config-lf-Vlan3)#exit
XGS3-42000R(config)#ipv6 access-list 500 permit ff1e::1/64
XGS3-42000R(config)#ip pim ssm range 500
```

44.4.4 PIM-SSM6 Troubleshooting

When configuring the PIM-SSM6 protocol, it may fail to work because of the failure of physical connection or the mis-configurations. To debug these errors, attention should be paid to the following lists.

- Make sure the physical links are connected correctly.
- Make sure the state of the data link layer has become UP. (Use show interface command).
- Make sure PIM6 is enabled in global configuration mode (Refer to the command `ipv6 pim multicast-routing`).
- Make sure PIM-SM6 is configured on the interface (Refer to the command `ipv6 pim sparse-mode`)
- Make sure SSM6 is configure in global configuration mode.
- The multicast protocol uses the unicast routing to make RPF check. Hence, single-cast routing should be verified firstly.

If problems could not be fixed with the above check list, please enable the command of **debug ipv6 pim event and debug ipv6 pim packet**, and save the debug information for 3 minutes, and send it to Technology Service Center.

44.5 IPv6 DCSCM

44.5.1 Introduction to IPv6 DCSCM

The technology of IPv6 DCSCM (Destination Control and Source Control Multicast) includes three aspects: the multicast source control, the multicast user control and the service-priority-oriented policy multicast.

IPv6 DCSCM Controllable Multicast technology proceeds as the following way:

1. If source controlled multicast is configured on the edge switches, only the multicast data of the specified group from the specified source can pass.
2. The RP switches which are the core of PIM-SM will directly send REGISTER_STOP as response to the REGISTER messages not from the specified source and specified group, and no entry is allowed to be created. (This task is implemented in the PIM-SM module).

The control of multicast users of IPv6 DCSCM technology is implemented on the basis of controlling the MLD message sent from the users, so the control module is MLD snooping and the MLD module, the control logic of which includes the following three methods: controlling according to the VLAN+MAC sending the message, controlling according to the IP address sending the message, and controlling according to the input port of the message. MLD snooping can adopt all the three methods at the same time, while the MLD module, at the third layer, can only control the IP address sending the message.

The service-priority-oriented policy multicast of IPv6 DCSCM technology adopts the following method: for the confined multicast data, the user-specified priority will be set at the access point, enabling the data can be sent at a higher priority through TRUNK, and guaranteeing that the data can be sent through the whole net at the user-specified priority.

44.5.2 IPv6 DCSCM Configuration Task Sequence

- 1 · The source control configuration
- 2 · The destination control configuration
- 3 · The multicast policy configuration

1 · The source control configuration

The source control configuration has three steps, first is globally enabling the source control, the following is the command of globally enabling the source control:

Command	Explanation
Global Configuration Mode	
ipv6 multicast source-control(necessary) no ipv6 multicast source-control	Globally enable the source control, the no operation of this command will globally disable the source control. What should be paid attention to is that, once globally enable the source control, all the multicast messages will be dropped by default. All the source control configurations can only be done after globally enabled, and only when all the configured rules are disabled, the source control can be disabled globally.

The next is configuring the source control rules, which adopts the same method as configuring ACL, using ACL number from 8000 to 8099, while each rule number can configure 10 rules. What should be paid attention to is that these rules have orders, the earliest configured rule is at the front. Once a rule is matched, the following ones will not take effect, so the globally enabled rules should be the last to configure. The following is the command:

Command	Explanation
Global Configuration Mode	
[no] ipv6 access-list <8000-8099> {deny permit} {{<source/M>}{host-source <source-host-ip>}any-source} {{<destination/M> }{host-destination <destination-host-ip>}any-destination}	Used to configure the source control rules, the rules can only take effect when applied to the specified port. The no operation of this command can delete the specified rule.

The last is to configure the rules to the specified port.

Pay attention: since the configured rules will take up entries of hardware, configuring too many rules might cause failure if the underlying entries are full, so it is recommended that users adopt rules as simple as possible. The following is the configuration command:

Command	Explanation
Port Configuration Mode	
[no] ipv6 multicast source-control access-group <8000-8099>	Used to configure the source control rule to a port, the no operation will cancel this configuration.

2 · The configuration of destination control

The configuration of destination control is similar to that of source control, and also has three steps:

First, globally enable the destination control, since destination control needs to avoid the unauthorized users from receiving multicast data, once it is enabled globally, the switch will stop broadcasting received multicast data, so if a switch has enabled destination control, users should not connect two or more other Layer three switches within the same VLAN where it locates. The following is the configuration command:

Command	Explanation
Global Configuration Mode	
multicast destination-control(necessary)	Globally enable IPV4 and IPv6 destination control, the no operation of this command will globally disable destination control. All of the other configuration can only take effect after globally enabled.

The next is configuring destination control rules, which are similar to that of source control, but using ACL number from 9000 to 10099 instead.

Command	Explanation
Global Configuration Mode	
[no] ipv6 access-list <9000-10099> {deny permit} {{<source/M>}{host-source <source-host-ip>} any-source} {{<destination/M>}{host-destination <destination-host-ip>} any-destination}	Used to configure destination control rules, these rules can only take effect when applied to specified source IP, VLAN-MAC or port. The no operation of this rule will delete the specified rule.

The last step is to configure the rules to the specified source IP, source VLAN MAC or the specified port. What should be paid attention to is that only when the MLD-SNOOPING is enabled, these rules can be globally used, or, only rules of source IP can be used in MLD protocol. The following is the configuration command:

Command	Explanation
Port Mode	
[no] ipv6 multicast destination-control access-group <9000-10099>	Used to configure the destination control rule to a port, the no operation of this command will cancel the configuration.
Global Configuration Mode	

[no] ipv6 multicast destination-control <1-4094> <macaddr> access-group <9000-10099>	Used to configure the destination control rules to the specified VLAN-MAC, the no operation of this command will cancel the configuration.
[no] ipv6 multicast destination-control <IPADDRESS/M> access-group <9000-100999>	Used to configure the destination control rules to the specified source IPv6 address/MASK, the no operation of this command will cancel the configuration.

3 · The configuration of multicast policy

The multicast policy adopts the method of specifying a priority for the specified multicast data to meet the user's particular demand, what should be paid attention to is that only when multicast data is transmitted in TRUNK, can it be taken special care of. The configuration is quite simple, for only one command is needed, that is set priority for the specified multicast, the following is the command:

Command	Explanation
Global Configuration Mode	
[no] ipv6 multicast policy <IPADDRESS/M> <IPADDRESS/M> cos <priority>	Configure multicast policy, set priority for sources and groups in a specified range, the priority valid range is 0 to 7.

44.5.3 IPv6 DCSCM Typical Examples

1 · Source control

In order to prevent an edge switch sends multicast data at will, we configure on the edge switch that only the switch whose port is Ethernet1/5 can send multicast data, and the group of data should be ff1e::1. The uplink port Ethernet1/25 can forward multicast data without being restricted, so we can configure as follows.

```
XGS3-42000R(config)#ipv6 access-list 8000 permit any-source ff1e::1
XGS3-42000R(config)#ipv6 access-list 8001 permit any any
XGS3-42000R(config)#ipv6 multicast source-control
XGS3-42000R(config)#interface Ethernet1/5
XGS3-42000R(config-if-Ethernet1/5)#ipv6 multicast source-control access-group 8000
XGS3-42000R(config)#interface Ethernet1/25
XGS3-42000R(config-if-Ethernet1/25)#ipv6 multicast source-control access-group 8001
```

2 · Destination control

We want to confine that the users of the segment whose address is fe80::203:fff:fe01:228a/64 can not join the ff1e::1/64 group, so we can configure as follows:

First, enable MLD Snooping in the VLAN where it locates (in this example, it is VLAN2).

```
XGS3-42000R(config)#ipv6 mld snooping
XGS3-42000R(config)#ipv6 mld snooping vlan 2
```

Then configure relative destination control access list and configure specified IPv6 address to use this access list.

```
XGS3-42000R(config)#ipv6 access-list 9000 deny any ff1e::1/64
XGS3-42000R(config)#ipv6 access-list 9000 permit any any
XGS3-42000R(config)#multicast destination-control
XGS3-42000R(config)#ipv6 multicast destination-control fe80::203:fff:fe01:228a/64 access-group 9000
```

Thus, the users of this segment can only join groups other than 2ff1e::1/64.

3 · Multicast policy

Server 2008::1 is sending important multicast data in group ff1e::1, we can configure on its access switch as follows:

```
XGS3-42000R(config)#ipv6 multicast policy 2008::1/128 ff1e::1/128 cos 4
```

Thus this multicast flow will have a priority of 4, when it passes the TRUNK port of this switch to another XGS3-42000R(generally speaking, it is a relatively high priority, the data with higher priority might be protocol data, if a higher priority is set, when there is too much multicast data, the switch protocol might operate abnormally).

44.5.4 IPv6 DCSCM Troubleshooting

IPv6 DCSCM module acts like ACL, so most problems are caused by improper configuration. Please read the instructions above carefully.

44.6 MLD

44.6.1 Introduction to MLD

MLD (Multicast Listener Discovery) is the multicast group member (receiver) discovery protocol serving IPv6 multicast. It is similar to IGMP Protocol in IPv4 multicast application. Correspondingly, MLD Protocol version1 is similar to IGMP Protocol version2, and MLD Protocol version2 is similar to IGMP Protocol version3. Current firmware supports MLDv1/ MLDv2.

The IPv6 multicast hosts can join or leave from multicast group at any location, any time, regardless of the total number of group members. It is unnecessary and impossible for multicast switch to store the relationship among all host members. Multicast switch simply finds out via MLD protocol if there are receivers of certain multicast group on the network segment connected to each port. The only thing host need to do is to keep the record of which multicast groups it joined.

MLD is unsymmetrical between host and switch: the host needs to respond the MLD query message of multicast switch with membership report message; the switch periodically sends membership query message and determines if there is host joining a specific group in its subnetworks according to the response message received, and after it receives the report of a host quitting from the group, it sends out the query for the group to confirm if there is no member left in it.

There are three types of protocol messages of MLD Protocol, that is, Query, Report and Done (which is corresponding to Leave of IGMPv2). Like IGMPv2, the Query messages include General Query and Specific Group Query. General Query uses the multicast address FF02::1 of hosts as destination address, the group address is 0; and Specific Group Query use its group address as destination address. The multicast addresses of MLD use 130, 131 and 132 as data types denoting the three kinds of messages mentioned above. Other logic is basically same as IGMPv2.

MLD protocol version2 use FF02::16 as destination address of membership report, and 143 as data type. The other logic of MLD Protocol version2 is similar to IGMP Protocol version3.

44.6.2 MLD Configuration Task List

- 1、Start MLD (Required)
- 2、Configure MLD auxiliary parameters (Required)
 - (1) Configure MLD group parameters
 - 1) Configure MLD group filter conditions
 - (2) Configure MLD query parameters
 - 1) Configure the interval of MLD sending query message
 - 2) Configure the maximum response time of MLD query
 - 3) Configure overtime of MLD query
- 3、Shut down MLD Protocol

1. Start MLD Protocol

There is no special command for starting MLD Protocol on EDGECORE series layer 3 switches. MLD Protocol will automatically start up as long as any IPv6 multicast protocol is started on corresponding interface.

Command	Explanation
Global Mode	
ipv6 pim multicast-routing	To start Global IPv6 Multicast Protocol, the precondition of starting MLD Protocol. The NO operation of corresponding command shuts ipv6 multicast protocol and MLD Protocol. (Required)

Command	Explanation
Port Configuration Mode	
ipv6 pim dense-mode ipv6 pim sparse-mode	Start MLD Protocol. The NO operation of corresponding command shuts MLD Protocol. (Required)

2. Configure MLD auxiliary parameters

(1) Configure MLD group parameters

1) Configure MLD group filter conditions

Command	Explanation
Port Configuration Mode	
ipv6 mld access-group <acl_name> no ipv6 mld access-group	Configure the filter conditions of interface for MLD group; the NO operation of this command cancels filter conditions.

(2) Configure MLD Query parameters

1) Configure interval time for MLD to send query messages

2) Configure the maximum response time of MLD query

3) Configure the overtime of MLD query

Command	Explanation
Port Configuration Mode	
ipv6 mld query-interval <time_val> no ipv6 mld query-interval	Configure the interval of MLD query messages sent periodically; the NO operation of this command restores the default value.
ipv6 mld query-max-response-time <time_val> no ipv6 mld query-max-response-time	Configure the maximum response time of the interface for MLD query; the NO operation of this command restores the default value.
ipv6 mld query-timeout <time_val> no ipv6 mld query-timeout	Configure the overtime of the interface for MLD query; the NO operation of this command restores the default value.

3. Shut down MLD Protocol

Command	Explanation
Port Configuration Mode	
no ipv6 pim dense-mode no ipv6 pim sparse-mode no ipv6 pim multicast-routing (Global Mode)	Shut down MLD Protocol

44.6.3 MLD Typical Application

As shown in the following figure, add the Ethernet interfaces of Switch A and Switch B to corresponding vlan, and start PIM6 on each vlan interface.

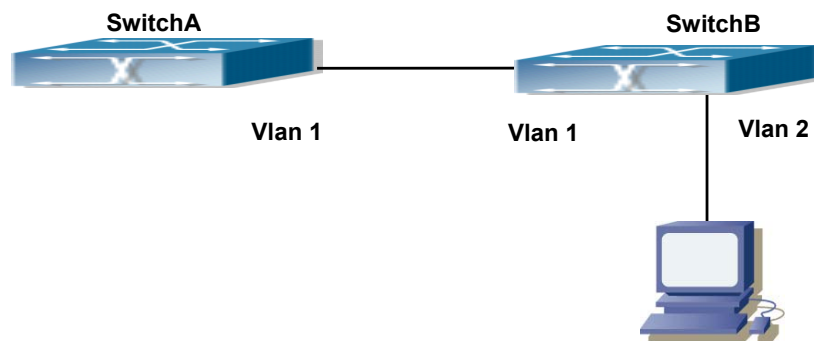

Figure 44-6-1 Network Topology Diagram

The configuration procedure for SwitchA and SwitchB is as below:

(1) Configure SwitchA:

```
XGS3-42000R(config) #ipv6 pim multicast-routing
XGS3-42000R(config) #ipv6 pim rp-address 3FFE::1
XGS3-42000R(config) #interface vlan 1
XGS3-42000R(Config-if-Vlan1) #ipv6 address 3FFE::1/64
XGS3-42000R(Config-if-Vlan1) #ipv6 pim sparse-mode
```

(2) Configure SwitchB:

```
XGS3-42000R(config) #ipv6 pim multicast-routing
XGS3-42000R(config) #ipv6 pim rp-address 3FFE::1
XGS3-42000R(config) #interface vlan1
XGS3-42000R(Config-if-Vlan1) #ipv6 address 3FFE::2/64
XGS3-42000R(Config-if-Vlan1) #ipv6 pim sparse-mode
XGS3-42000R(Config-if-Vlan1) #exit
XGS3-42000R(config) #interface vlan2
XGS3-42000R(Config-if-Vlan2) #ipv6 address 3FFA::1/64
XGS3-42000R(Config-if-Vlan2) #ipv6 pim sparse-mode
XGS3-42000R(Config-if-Vlan2) #ipv6 mld query-timeout 150
```

44.6.4 MLD Troubleshooting Help

When configuring and using MLD protocol, MLD protocol may fail to work normally due to physical connections, incorrect configuration and so on. So, users shall note the following points:

- Assure the physical connection is correct.

- Assure the protocol of interface and link is UP (use show interface command)
- Assure to start one kind of multicast protocol on the interface
- Assure the time of the timers of each router on the same network segment is consistent; usually we recommend the default setting.
- Unicast route shall be used to carry out RPF examination for multicast protocol. So the correctness of unicast route shall be guaranteed above all.

If all attempts fail to solve the problems on MLD, please use debug commands such as debug ipv6 MLD event/packet, and copy DEBUG information in 3 minutes and send to Technology Service Center.

44.7 MLD Snooping

44.7.1 Introduction to MLD Snooping

MLD, the Multicast Listener Discovery Protocol, is used to realize multicasting in the IPv6. MLD is used by the network equipments such as routers which supports multicast for multicast listener discovery, also used by listeners looking forward to join certain multicast group informing the router to receive data packets from certain multicast address, all of which are done through MLD message exchange. First the router send an MLD Multicast listener Query message through a multicast address which can address all the listeners (namely ff02::1). Once there is a listener who wishes to join the multicast address, it will send a MLD Multicast listener Report back through the multicast address.

MLD Snooping is namely the MLD listening. The switch restricts the multicast traffic from flooding through MLD Snooping, and forward the multicast traffic to ports associated to multicast devices only. The switch listens to the MLD messages between multicast routers and listeners, and maintains the multicast group forwarding list based on the listening result. The switches forwards multicast packets according to the multicast forwarding list

The switch realizes the MLD Snooping function while supporting MLD v2. This way, the user can acquire IPv6 multicast with the switch.

44.7.2 MLD Snooping Configuration Task

1. Enable the MLD Snooping function
2. Configure the MLD Snooping

1. Enable the MLD Snooping function

Command	Explanation
Global Mode	
ipv6 mld snooping no ipv6 mld snooping	Enable global MLD Snooping, the “ no ipv6 mld snooping ” command disables the global MLD snooping.

2. Configure MLD Snooping

Command	Explanation
Global Mode	
ipv6 mld snooping vlan <vlan-id> no ipv6 mld snooping vlan <vlan-id>	Enable MLD Snooping on specific VLAN. The “no” form of this command disables MLD Snooping on specific VLAN.
ipv6 mld snooping vlan <vlan-id> limit {group <g_limit> source <s_limit>} no ipv6 mld snooping vlan <vlan-id> limit	Configure the number of the groups in which the MLD Snooping can join, and the maximum number of sources in each group. The “no” form of this command restores to the default.
ipv6 mld snooping vlan <vlan-id> l2-general-querier no ipv6 mld snooping vlan <vlan-id> l2-general-querier	Set the VLAN level 2 general querier, which is recommended on each segment. The “no” form of this command cancels the level 2 general querier configuration.
ipv6 mld snooping vlan <vlan-id> mrouter-port interface <interface -name> no ipv6 mld snooping vlan <vlan-id> mrouter-port interface <interface -name>	Configure the static mrouter port in specific vlan. The “no” form of this command cancels the mrouter port configuration.
ipv6 mld snooping vlan <vlan-id> mrpt <value> no ipv6 mld snooping vlan <vlan-id> mrpt	Configure the keep-alive time of the mrouter port. The “no” form of this command restores to the default.
ipv6 mld snooping vlan <vlan-id> query-interval <value> no ipv6 mld snooping vlan <vlan-id> query-interval	Configure the query interval. The “no” form of this command restores to the default.
ipv6 mld snooping vlan <vlan-id> immediate-leave no ipv6 mld snooping vlan <vlan-id> immediate-leave	Configure immediate leave multicast group function for the MLD Snooping of specific VLAN. The “no” form of this command cancels the immediate leave configuration.
ipv6 mld snooping vlan <vlan-id> query-mrsp <value> no ipv6 mld snooping vlan <vlan-id> query-mrsp	Configure the query maximum response period. The “no” form of this command restores to the default.
ipv6 mld snooping vlan <vlan-id> query-robustness <value> no ipv6 mld snooping vlan <vlan-id> query-robustness	Configure the query robustness, the “no” form of this command restores to the default.
ipv6 mld snooping vlan <vlan-id> suppression-query-time <value> no ipv6 mld snooping vlan <vlan-id> suppression-query-time	Configure the suppression query time. The “no” form of this command restores to the default
l2 ipv6 mld snooping vlan <vlan-id> static-group <X:X::X:X> [source <X:X::X:X>] interface [ethernet port-channel] <IFNAME> no l2 ipv6 mld snooping vlan <vlan-id> static-group <X:X::X:X> [source <X:X::X:X>] interface [ethernet port-channel] <IFNAME>	Configure static-group on specified port of the VLAN. The no form of the command cancels this configuration.

44.7.3 MLD Snooping Examples

Scenario 1: MLD Snooping Function

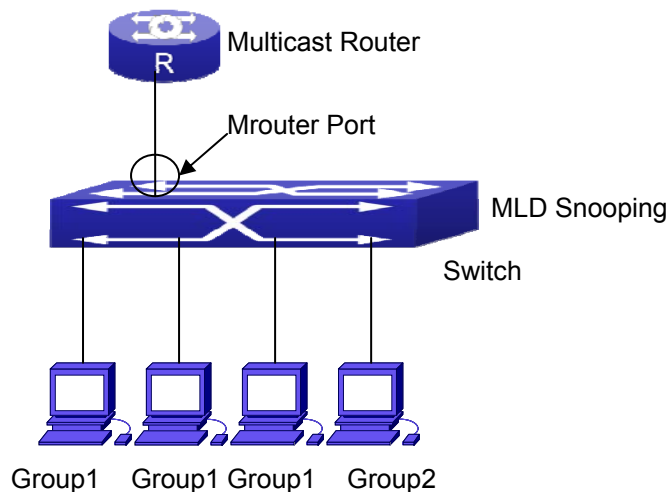

Figure 44-7-1 Open the switch MLD Snooping Function figure

As shown above, the vlan 100 configured on the switch consists of ports 1, 2, 6, 10, 12. Four hosts are respectively connected to 2, 6, 10, 12 while the multicast router on port 1. Suppose we need MLD Snooping on VLAN 100, however by default, the global MLD Snooping as well as the MLD Snooping on each VLAN are, therefore first we have to enable the global MLD Snooping at the same time enable the MLD Snooping on VLAN 100, furthermore we need to set the port 1 of VLAN 100 as a mrouter port.

Configuration procedure is as follows.

```
XGS3-42000R#config
XGS3-42000R(config)#ipv6 mld snooping
XGS3-42000R(config)#ipv6 mld snooping vlan 100
XGS3-42000R(config)#ipv6 mld snooping vlan 100 mrouter-port interface ethernet 1/1
```

Multicast configuration:

Assume there are two multicast servers: the Multicast Server 1 and the Multicast Server 2, amongst program 1 and 2 are supplied on the Multicast Server 1 while program 3 on the Multicast server 2, using group addresses respectively the Group 1, Group 2 and Group 3. Concurrently multicast application is operating on the four hosts. Two hosts connected to port 2 and 5 are playing program 1 while the host connected to port 10 playing program 2, and the one to port 12 playing program 3.

MLD Snooping interception results:

The multicast table on vlan 100 shows: port1, 2 and 6 are in (Multicasting Server 1, Group1) , port1, 10 are in (Multicasting Server 1,Group2), and port1, 12 are in (Multicasting Server 2, Group3)

All the four hosts successfully receive programs they are interested in. port2, 6 receives no traffic from program2 and 3; port10 receives no traffic from program 1 and 3, and port12 receives no traffic from program1 and 2.

Scenario 2: MLD L2-general-querier

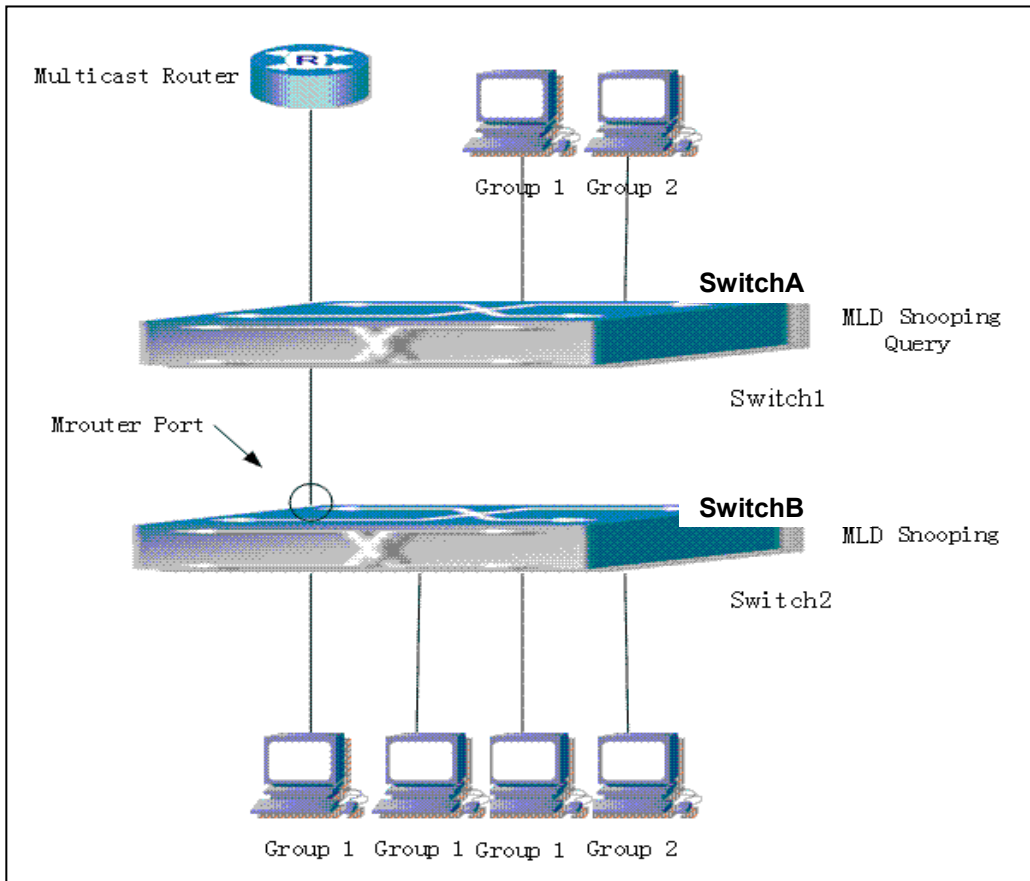

Figure 44-7-2 Switch as MLD Querier Function figure

Configuration of switch B is the same as the switches in case 1, and here the switch 1 replaces the Multicast Router in case 1. Assume the vlan 60 configured on it contains port 1, 2, 10, 12, amongst port 1 is connected to multicast server, port 2 to switch2. To send Query periodically, global MLD Snooping has to be enabled while executing the mld snooping vlan 60 l2-general-querier, setting the vlan 60 to a Level 2 General Querier. Configuration procedure is as follows:

```
SwitchA#config
SwitchA(config)#ipv6 mld snooping
SwitchA(config)#ipv6 mld snooping vlan 60
SwitchA(config)#ipv6 mld snooping vlan 60 l2-general-querier
SwitchB#config
SwitchB(config)#ipv6 mld snooping
SwitchB(config)#ipv6 mld snooping vlan 100
SwitchB(config)#ipv6 mld snooping vlan 100 mrouter interface ethernet 1/1
```

Multicast configuration:

Same as scenario 1

MLD Snooping interception results:

Same as scenario 1

Scenario 3: To run in cooperation with layer 3 multicast protocols

SWITCH which is used in Scenario 1 is replaced with ROUTER with specific configurations remains the same. And multicast and IGMP snooping configurations are the same with what it is in Scenario 1. To configure PIM-SM6 on ROUTER, and enable PIM-SM6 on vlan 100 (use the same PIM mode with the connected multicast router), the configurations are listed as below:

```
XGS3-42000R#config
XGS3-42000R(config)#ipv6 pim multicast-routing
XGS3-42000R(config)#interface vlan 100
XGS3-42000R(config-if-vlan100)#ipv6 pim sparse-mode
```

MLD snooping does not distribute entries when layer 3 multicast protocol is enabled. It only does the following tasks.

- To remove the layer 2 multicast entries.
- To provide query functions to the layer 3 with vlan, S, and G as the parameters.
- When layer 3 MLD is disabled, re-enable distributing layer 2 multicast entries.

By looking up the layer 3 IP6MC entries, it can be found that ports can be indicated by the layer 3 multicast entries. This ensures the MLD Snooping can work in cooperation with the layer 3 multicast protocols.

44.7.4 MLD Snooping Troubleshooting

In configuring and using MLD Snooping, the MLD Snooping server may fail to run properly due to physical connection failure, wrong configuration, etc. The user should ensure the following:

- Ensure the physical connection is correct
- Ensure the MLD Snooping is enabled under global mode (using ipv6 mld snooping)
- Ensure the MLD Snooping is configured on the vlan under global mode (using ipv6 mld snooping vlan <vlan-id>)
- Ensure there is a vlan configured as a L2 general querier, or there is a static mrouter configured in a segment,
- Use command to check if the MLD snooping information is correct

Chapter 45 Multicast VLAN

45.1 Introductions to Multicast VLAN

Based on current multicast order method, when orders from users in different VLAN, each VLAN will copy a multicast traffic in this VLAN, which is a great waste of the bandwidth. By configuration of the multicast VLAN, we add the switch port to the multicast VLAN, with the IGMP Snooping/MLD Snooping functions enabled, users from different VLAN will share the same multicast VLAN. The multicast traffic only exists within a multicast VLAN, so the bandwidth is saved. As the multicast VLAN is absolutely separated from the user VLAN, security and bandwidth concerns can be met at the same time, after the multicast VLAN is configured, the multicast traffic will be continuously sent to the users.

45.2 Multicast VLAN Configuration Task List

- 1 · Enable the multicast VLAN function
- 2 · Configure the IGMP Snooping
- 3 · Configure the MLD Snooping

1. Enable the multicast VLAN function

Command	Explanation
VLAN configuration mode	
multicast-vlan no multicast-vlan	Configure a VLAN and enable the multicast VLAN on it. The “ no multicast-vlan ” command disables the multicast function on the VLAN.
multicast-vlan association <vlan-list> no multicast-vlan association <vlan-list>	Associate a multicast VLAN with several VLANs. The “no” form of this command deletes the related VLANs associated with the multicast VLAN.

2. Configure the IGMP Snooping

Command	Explanation
Global Mode	
ip igmp snooping vlan <vlan-id> no ip igmp snooping vlan <vlan-id>	Enable the IGMP Snooping function on the multicast VLAN. The “no” form of this command disables the IGMP Snooping on the multicast VLAN.
ip igmp snooping no ip igmp snooping	Enable the IGMP Snooping function. The “no” form of this command disables the IGMP snooping function.

3. Configure the MLD Snooping

Command	Explanation
Global Mode	
<code>ipv6 mld snooping vlan <vlan-id></code> <code>no ipv6 mld snooping vlan <vlan-id></code>	Enable MLD Snooping on multicast VLAN; the “no” form of this command disables MLD Snooping on multicast VLAN.
<code>ipv6 mld snooping</code> <code>no ipv6 mld snooping</code>	Enable the MLD Snooping function. The “no” form of this command disables the MLD snooping function.

45.3 Multicast VLAN Examples

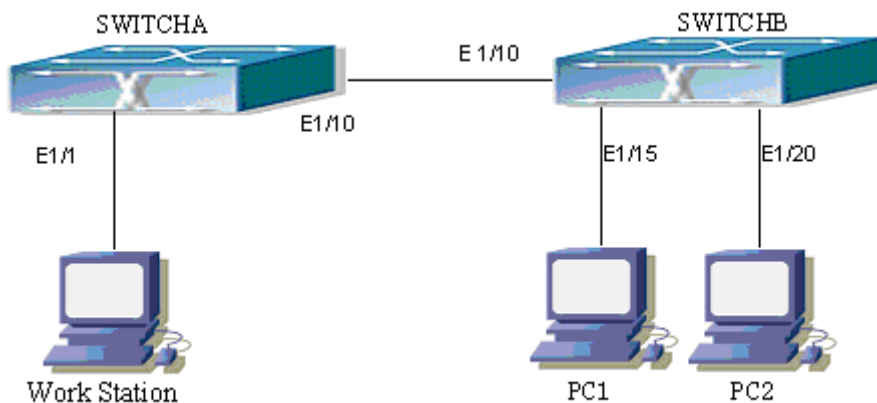

Figure 45-3-1 Function configuration of the Multicast VLAN

As shown in the figure, the multicast server is connected to the layer 3 switch switchA through port 1/1 which belongs to the VLAN10 of the switch. The layer 3 switch switchA is connected with layer 2 switches through the port1/10, which configured as trunk port. On the switchB the VLAN100 is configured set to contain port1/15, and VLAN101 to contain port1/20. PC1 and PC2 are respectively connected to port 1/15 and1/20. The switchB is connected with the switchA through port1/10, which configured as trunk port. VLAN 20 is a multicast VLAN. By configuring multicast vlan, the PC1 and PC2 will receives the multicast data from the multicast VLAN.

Following configuration is based on the IP address of the switch has been configured and all the equipment are connected correctly.

Configuration procedure

```
SwitchA#config
SwitchA(config)#vlan 10
SwitchA(config-vlan10)#switchport access ethernet 1/1
SwitchA(config-vlan10)exit
```

```
SwitchA(config)#interface vlan 10
XGS3-42000R(config-if-Vlan10)#ip pim dense-mode
XGS3-42000R(config-if-Vlan10)#exit
SwitchA(config)#vlan 20
SwitchA(config-vlan20)#exit
SwitchA(config)#interface vlan 20
SwitchA(Config-if-Vlan20)#ip pim dense-mode
SwitchA(Config-if-Vlan20)#exit
SwitchA(config)#ip pim multicast
SwitchA(config)# interface ethernet1/10
SwitchA(Config-lf-Ethernet1/10)switchport mode trunk
```

```
SwitchB#config
SwitchB(config)#vlan 100
SwitchB(config-vlan100)#Switchport access ethernet 1/15
SwitchB(config-vlan100)exit
SwitchB(config)#vlan 101
SwitchB(config-vlan101)#Switchport access ethernet 1/20
SwitchB(config-vlan101)exit
SwitchB(config)# interface ethernet 1/10
SwitchB(Config-lf-Ethernet1/10)#Switchport mode trunk
SwitchB(Config-lf-Ethernet1/10)#exit
SwitchB(config)#vlan 20
SwitchB(config-vlan20)#multicast-vlan
SwitchB(config-vlan20)#multicast-vlan association 100,101
SwitchB(config-vlan20)#exit
SwitchB(config)#ip igmp snooping
SwitchB(config)#ip igmp snooping vlan 20
```

When the multicast VLAN supports the IPv6 multicast, the usage is the same with IPv4, but the difference is using with MLD Snooping, so does not give an example.

Chapter 46 ACL Configuration

46.1 Introduction to ACL

ACL (Access Control List) is an IP packet filtering mechanism employed in switches, providing network traffic control by granting or denying access the switches, effectively safeguarding the security of networks. The user can lay down a set of rules according to some information specific to packets, each rule describes the action for a packet with certain information matched: “permit” or “deny”. The user can apply such rules to the incoming direction of switch ports, so that data streams in the incoming direction of specified ports must comply with the ACL rules assigned.

46.1.1 Access-list

Access-list is a sequential collection of conditions that corresponds to a specific rule. Each rule consist of filter information and the action when the rule is matched. Information included in a rule is the effective combination of conditions such as source IP, destination IP, IP protocol number and TCP port, UDP port. Access-lists can be categorized by the following criteria:

- Filter information based criterion: IP access-list (layer 3 or higher information), MAC access-list (layer 2 information), and MAC-IP access-list (layer 2 or layer 3 or higher).
- Configuration complexity based criterion: standard and extended, the extended mode allows more specific filtering of information.
- Nomenclature based criterion: numbered and named.

Description of an ACL should cover the above three aspects.

46.1.2 Access-group

When a set of access-lists are created, they can be applied to traffic of incoming direction on all ports. Access-group is the description to the binding of an access-list to the incoming direction on a specific port. When an access-group is created, all packets from in the incoming direction through the port will be compared to the access-list rule to decide whether to permit or deny access.

The current firmware only supports ingress ACL configuration.

46.1.3 Access-list Action and Global Default Action

There are two access-list actions and default actions: “permit” or “deny”. The following rules apply:

- An access-list can consist of several rules. Filtering of packets compares packet conditions to the rules, from the first rule to the first matched rule; the rest of the rules will not be processed.
- Global default action applies only to IP packets in the incoming direction on the ports.

- Global default action applies only when packet filter is enabled on a port and no ACL is bound to that port, or no binding ACL matches.

46.2 ACL Configuration Task List

ACL Configuration Task Sequence:

1. Configuring access-list
 - (1) Configuring a numbered standard IP access-list
 - (2) Configuring a numbered extended IP access-list
 - (3) Configuring a standard IP access-list based on nomenclature
 - a) Create a standard IP access-list based on nomenclature
 - b) Specify multiple “permit” or “deny” rule entries.
 - c) Exit ACL Configuration Mode
 - (4) Configuring an extended IP access-list based on nomenclature.
 - a) Create an extensive IP access-list based on nomenclature
 - b) Specify multiple “permit” or “deny” rule entries
 - c) Exit ACL Configuration Mode
 - (5) Configuring a numbered standard MAC access-list
 - (6) Configuring a numbered extended MAC access-list
 - (7) Configuring a extended MAC access-list based on nomenclature
 - a) Create a extensive MAC access-list based on nomenclature
 - b) Specify multiple “permit” or “deny” rule entries.
 - c) Exit ACL Configuration Mode
 - (8) Configuring a numbered extended MAC-IP access-list
 - (9) Configuring a extended MAC-IP access-list based on nomenclature
 - a) Create a extensive MAC-IP access-list based on nomenclature
 - b) Specify multiple “permit” or “deny” rule entries.
 - c) Exit MAC-IP Configuration Mode
 - (10) Configuring a numbered standard IPV6 access-list
 - (11) Configuring a numbered extended IPV6access-list
 - (12) Configuring a standard IPV6 access-list based on nomenclature
 - a) Create a standard IPV6 access-list based on nomenclature
 - b) Specify multiple permit or deny rule entries
 - c) Exit ACL Configuration Mode
 - (13) Configuring an extended IPV6 access-list based on nomenclature.
 - a) Create an extensive IPV6 access-list based on nomenclature
 - b) Specify multiple permit or deny rule entries.
 - c) Exit ACL Configuration Mode
2. Configuring the packet filtering function
 - (2) Enable global packet filtering function
 - (3) Configure default action.
3. Configuring time range function

- (4) Create the name of the time range
 - (5) Configure periodic time range
 - (6) Configure absolute time range
4. Bind access-list to a incoming direction of the specified port
 5. Clear the filtering information of the specified port

1. Configuring access-list

(1) Configuring a numbered standard IP access-list

Command	Explanation
Global Mode	
<pre>access-list <num> {deny permit} {{<slpAddr> <sMask>} any-source {host-source <slpAddr>}} no access-list <num></pre>	Creates a numbered standard IP access-list, if the access-list already exists, then a rule will add to the current access-list; the “no access-list <num>” command deletes a numbered standard IP access-list.

(2) Configuring a numbered extensive IP access-list

Command	Explanation
Global Mode	
<pre>access-list <num> {deny permit} icmp {{<slpAddr> <sMask>} any-source {host-source <slpAddr>}} {{<dIpAddr> <dMask>} any-destination {host-destination <dIpAddr>}} [<icmp-type> [<icmp-code>]] [precedence <prec>] [tos <tos>][time-range<time-range-name>]</pre>	Creates a numbered ICMP extended IP access rule; if the numbered extended access-list of specified number does not exist, then an access-list will be created using this number.
<pre>access-list <num> {deny permit} igmp {{<slpAddr> <sMask>} any-source {host-source <slpAddr>}} {{<dIpAddr> <dMask>} any-destination {host-destination <dIpAddr>}} [<igmp-type>] [precedence <prec>] [tos <tos>][time-range<time-range-name>]</pre>	Creates a numbered IGMP extended IP access rule; if the numbered extended access-list of specified number does not exist, then an access-list will be created using this number.
<pre>access-list <num> {deny permit} tcp {{<slpAddr> <sMask>} any-source {host-source <slpAddr>}} [s-port { <sPort> range <sPortMin> <sPortMax> }] {{<dIpAddr> <dMask>} any-destination {host-destination <dIpAddr>}} [d-port { <dPort> range <dPortMin> <dPortMax> }] [ack+fin+psh+rst+urg+syn] [precedence <prec>] [tos <tos>][time-range<time-range-name>]</pre>	Creates a numbered TCP extended IP access rule; if the numbered extended access-list of specified number does not exist, then an access-list will be created using this number.
<pre>access-list <num> {deny permit} udp {{<slpAddr></pre>	Creates a numbered UDP

<code><sMask> any-source {host-source <slpAddr>} [s-port { <sPort> range <sPortMin> <sPortMax> }] {{<dIpAddr> <dMask>} any-destination {host-destination <dIpAddr>}} [d-port { <dPort> range <dPortMin> <dPortMax> }] [precedence <prec>] [tos <tos>][time-range<time-range-name>]</code>	extended IP access rule; if the numbered extended access-list of specified number does not exist, then an access-list will be created using this number.
<code>access-list <num> {deny permit} {eigrp gre igmp ipinip ip ospf <protocol-num>} {{<slpAddr> <sMask> any-source {host-source <slpAddr>}} {{<dIpAddr> <dMask>} any-destination {host-destination <dIpAddr>}} [precedence <prec>] [tos <tos>][time-range<time-range-name>]</code>	Creates a numbered IP extended IP access rule for other specific IP protocol or all IP protocols; if the numbered extended access-list of specified number does not exist, then an access-list will be created using this number.
<code>no access-list <num></code>	Deletes a numbered extensive IP access-list.

(3) Configuring a standard IP access-list basing on nomenclature

a. Create a name-based standard IP access-list

Command	Explanation
Global Mode	
<code>ip access-list standard <name></code> <code>no ip access-list standard <name></code>	Creates a standard IP access-list based on nomenclature; the “ no ip access-list standard <name> ” command deletes the name-based standard IP access-list.

b. Specify multiple “permit” or “deny” rules

Command	Explanation
Standard IP ACL Mode	
<code>[no] {deny permit} {{<slpAddr> <sMask>} any-source {host-source <slpAddr>}}</code>	Creates a standard name-based IP access rule; the “ no ” form command deletes the name-based standard IP access rule.

c. Exit name-based standard IP ACL configuration mode

Command	Explanation
Standard IP ACL Mode	
<code>exit</code>	Exits name-based standard IP ACL configuration mode.

(4) Configuring an name-based extended IP access-list

a. Create an extended IP access-list basing on nomenclature

Command	Explanation
Global Mode	
<pre>ip access-list extended <name> no ip access-list extended <name></pre>	Creates an extended IP access-list basing on nomenclature; the “no ip access-list extended <name>” command deletes the name-based extended IP access-list.

b. Specify multiple “permit” or “deny” rules

Command	Explanation
Extended IP ACL Mode	
<pre>[no] {deny permit} icmp {{<slpAddr> <sMask>} any-source {host-source <slpAddr>}} {{<dIpAddr> <dMask>} any-destination {host-destination <dIpAddr>}} [<icmp-type> [<icmp-code>]] [precedence <prec>] [tos <tos>][time-range<time-range-name>]</pre>	Creates an extended name-based ICMP IP access rule; the “no” form command deletes this name-based extended IP access rule.
<pre>[no] {deny permit} igmp {{<slpAddr> <sMask>} any-source {host-source <slpAddr>}} {{<dIpAddr> <dMask>} any-destination {host-destination <dIpAddr>}} [<igmp-type>] [precedence <prec>] [tos <tos>][time-range<time-range-name>]</pre>	Creates an extended name-based IGMP IP access rule; the “no” form command deletes this name-based extended IP access rule.
<pre>[no] {deny permit} tcp {{<slpAddr> <sMask>} any-source {host-source <slpAddr>}} [s-port { <sPort> range <sPortMin> <sPortMax> }] {{<dIpAddr> <dMask>} any-destination {host-destination <dIpAddr>}} [d-port { <dPort> range <dPortMin> <dPortMax> }] [ack+fin+psh+rst+urg+syn] [precedence <prec>] [tos <tos>][time-range<time-range-name>]</pre>	Creates an extended name-based TCP IP access rule; the “no” form command deletes this name-based extended IP access rule.
<pre>[no] {deny permit} udp {{<slpAddr> <sMask>} any-source {host-source <slpAddr>}} [s-port { <sPort> range <sPortMin> <sPortMax> }] {{<dIpAddr> <dMask>} any-destination {host-destination <dIpAddr>}} [d-port { <dPort> range <dPortMin> <dPortMax> }] [precedence <prec>] [tos <tos>][time-range<time-range-name>]</pre>	Creates an extended name-based UDP IP access rule; the “no” form command deletes this name-based extended IP access rule.
<pre>[no] {deny permit} {eigrp gre igmp ipinip ip ospf <protocol-num>} {{<slpAddr> <sMask>} </pre>	Creates an extended name-based IP access rule

any-source {host-source <slpAddr>} {<dIpAddr> <dMask>} any-destination {host-destination <dIpAddr>} [precedence <prec>] [tos <tos>][time-range<time-range-name>]	for other IP protocols; the “no” form command deletes this name-based extended IP access rule.
--	--

c. Exit extended IP ACL configuration mode

Command	Explanation
Extended IP ACL Mode	
exit	Exits extended name-based IP ACL configuration mode.

(5) Configuring a numbered standard MAC access-list

Command	Explanation
Global Mode	
access-list<num>{deny permit}{any-source-mac {host-source-mac<host_smac>}}{<smac><smac-mask>} } no access-list <num>	Creates a numbered standard MAC access-list, if the access-list already exists, then a rule will add to the current access-list; the “no access-list <num>” command deletes a numbered standard MAC access-list.

(6) Creates a numbered MAC extended access-list

Command	Explanation
Global Mode	
access-list<num> {deny permit} {any-source-mac {host-source-mac<host_smac>}}{<smac><smac-mask>}}{any-destination-mac {host-destination-mac<host_dmac>}}{<dmac><dmac-mask>}}[untagged-eth2 tagged-eth2 untagged-802-3 tagged-802-3][<offset1> <length1> <value1> [<offset2> <length2> <value2> [<offset3> <length3> <value3> [<offset4> <length4> <value4>]]]] no access-list <num>	Creates a numbered MAC extended access-list, if the access-list already exists, then a rule will add to the current access-list; the “no access-list <num>” command deletes a numbered MAC extended access-list.

(7) Configuring a extended MAC access-list based on nomenclature

a. Create a extensive MAC access-list based on nomenclature

Command	Explanation
Global Mode	
mac-access-list extended <name> no mac-access-list extended <name>	Creates an extended name-based MAC access rule

	for other IP protocols; the “no” form command deletes this name-based extended MAC access rule.
--	---

b. Specify multiple “permit” or “deny” rule entries

Command	Explanation
Extended name-based MAC access rule Mode	
<pre>[no]{deny permit}{any-source-mac}{host-source-mac<host_smac>}{<smac><smac-mask>} {any-destination-mac}{host-destination-mac<host_dmac>} {<dmac> <dmac-mask>} [cos <cos-val> [<cos-bitmask>] [vlanId <vid-value> [<vid-mask>][ethertype<protocol>[<protocol-mask>]]]</pre>	Creates an extended name-based MAC access rule matching MAC frame; the “no” form command deletes this name-based extended MAC access rule.
<pre>[no]{deny permit}{any-source-mac}{host-source-mac<host_smac>}{<smac><smac-mask>} {any-destination-mac}{host-destination-mac<host_dmac>} {<dmac><dmac-mask>}[ethertype<protocol>[<protocol-mask>]]]</pre>	Creates an extended name-based MAC access rule matching untagged ethernet 2 frame; the “no” form command deletes this name-based extended MAC access rule.
<pre>[no]{deny permit}{any-source-mac}{host-source-mac<host_smac>}{<smac><smac-mask>} {any-destination-mac}{host-destination-mac<host_dmac>} {<dmac><dmac-mask>}[untagged-eth2 [ethertype <protocol> [protocol-mask]]]</pre>	Creates an MAC access rule matching 802.3 frame; the “no” form command deletes this MAC access rule.
<pre>[no]{deny permit}{any-source-mac}{host-source-mac<host_smac>}{<smac><smac-mask>} {any-destination-mac}{host-destination-mac<host_dmac>} {<dmac><dmac-mask>}[tagged-eth2 [cos <cos-val></pre>	Creates an MAC access rule matching tagged ethernet 2 frame; the “no” form command deletes this MAC

[<cos-bitmask>] [vlanId <vid-value> [<vid-mask>]] [ethertype<protocol> [<protocol-mask>]]	access rule.
[no]{deny permit}{any-source-mac}{host-source-mac <host_smac>}{<smac><smac-mask>} {any-destination-mac}{host-destination-mac<host_dmac>}{<dmac><dmac-mask>} [tagged-802-3 [cos <cos-val> [<cos-bitmask>]] [vlanId <vid-value> [<vid-mask>]]	Creates an MAC access rule matching tagged 802.3 frame; the “no” form command deletes this MAC access rule.

c. Exit ACL Configuration Mode

Command	Explanation
Extended name-based MAC access configure Mode	
exit	Quit the extended name-based MAC access configure mode.

(8) Configuring a numbered extended MAC-IP access-list

Command	Explanation
Global mode	
access-list<num>{deny permit} {any-source-mac {host-source-mac <host_smac>} {<smac> <smac-mask>}} {any-destination-mac {host-destination-mac <host_dmac>} {<dmac><dmac-mask>}} icmp {{<source> <source-wildcard>} any-source {host-source <source-host-ip>}} {{<destination> <destination-wildcard>} any-destination {host-destination <destination-host-ip>}} [<icmp-type> [<icmp-code>]] [precedence <precedence>] [tos <tos>] [time-range <time-range-name>]	Creates a numbered mac-icmp extended mac-ip access rule; if the numbered extended access-list of specified number does not exist, then an access-list will be created using this number.
access-list<num>{deny permit}{any-source-mac {host-source-mac<host_smac>}}{<smac><smac-ma sk>}} {any-destination-mac{ host-destination-mac <host_dmac>}}{<dmac><dmac-mask>}}igmp {{<source><source-wildcard>} any-source {host-source<source-host-ip>}} {{<destination><destination-wildcard>} any-destinati on {host-destination<destination-host-ip>}} [<igmp-type>] [precedence <precedence>] [tos <tos>][time-range<time-range-name>]	Creates a numbered mac-igmp extended mac-ip access rule; if the numbered extended access-list of specified number does not exist, then an access-list will be created using this number.
access-list<num>{deny permit}{any-source-mac {host-source-mac<host_smac>}}{<smac><smac-ma	Creates a numbered mac-ip extended mac-tcp access

<pre>sk>}}{any-destination-mac}{host-destination-mac <host_dmac>}}{<dmac><dmac-mask>}}tcp {{<source><source-wildcard>}}any-source {host-source<source-host-ip>}} [s-port { <port1> range <sPortMin> <sPortMax> }] {{<destination><destination-wildcard>}}any-destinati on {host-destination <destination-host-ip>}} [d-port { <port3> range <sPortMin> <sPortMax> }] [ack+fin+psh+rst+urg+syn] [precedence <precedence>] [tos <tos>][time-range<time-range-name>]</pre>	<p>rule; if the numbered extended access-list of specified number does not exist, then an access-list will be created using this number.</p>
<pre>access-list<num>{deny permit}{any-source-mac {host-source-mac<host_smac>}}{<smac><smac-ma sk>}}{any-destination-mac}{host-destination-mac <host_dmac>}}{<dmac><dmac-mask>}}udp {{<source><source-wildcard>}}any-source {host-source<source-host-ip>}} [s-port { <port1> range <sPortMin> <sPortMax> }] {{<destination><destination-wildcard>}}any-destinati on {host-destination <destination-host-ip>}} [d-port { <port3> range <sPortMin> <sPortMax> }] [precedence <precedence>] [tos <tos>][time-range<time-range-name>]</pre>	<p>Creates a numbered mac-udp extended mac-ip access rule; if the numbered extended access-list of specified number does not exist, then an access-list will be created using this number.</p>
<pre>access-list<num>{deny permit}{any-source-mac {host-source-mac<host_smac>}}{<smac><smac-ma sk>}} {any-destination-mac}{host-destination-mac <host_dmac>}}{<dmac><dmac-mask>}} {eigrp gre igrp ip ipinip ospf}{<protocol-num>}} {{<source><source-wildcard>}}any-source {host-source<source-host-ip>}} {{<destination><destination-wildcard>}}any-destinati on {host-destination <destination-host-ip>}} [precedence <precedence>] [tos <tos>][time-range<time-range-name>]</pre>	<p>Creates a numbered extended mac-ip access rule for other specific mac-ip protocol or all mac-ip protocols; if the numbered extended access-list of specified number does not exist, then an access-list will be created using this number.</p>
<pre>no access-list <num></pre>	<p>Deletes this numbered extended MAC-IP access rule.</p>

(9) Configuring a extended MAC-IP access-list based on nomenclature

a. Create a extensive MAC-IP access-list based on nomenclature

Command	Explanation
Global Mode	
mac-ip-access-list extended <name>	Creates an extended

no mac-ip-access-list extended <name>	name-based MAC-IP access rule; the “no” form command deletes this name-based extended MAC-IP access rule.
--	---

b. Specify multiple “permit” or “deny” rule entries

Command	Explanation
Extended name-based MAC-IP access Mode	
[no]{deny permit} {any-source-mac}{host-source-mac <host_smac>}{<smac><smac-mask>} {any-destination-mac}{host-destination-mac <host_dmac>}{<dmac><dmac-mask>}icmp {<source><source-wildcard>}any-source {host-source<source-host-ip>} {<destination><destination-wildcard>}any-destinati on {host-destination <destination-host-ip>} [<icmp-type> [<icmp-code>]] [precedence <precedence>][tos<tos>][time-range<time-range-na me>]	Creates an extended name-based MAC-ICMP access rule; the “no” form command deletes this name-based extended MAC-ICMP access rule.
[no]{deny permit}{any-source-mac}{host-source-ma c <host_smac>}{<smac><smac-mask>} {any-destination-mac}{host-destination-mac <host_dmac>}{<dmac><dmac-mask>}igmp {<source><source-wildcard>}any-source {host-source<source-host-ip>} {<destination><destination-wildcard>}any-destinati on {host-destination <destination-host-ip>} [<igmp-type>] [precedence <precedence>] [tos <tos>][time-range<time-range-name>]	Creates an extended name-based MAC-IGMP access rule; the “no” form command deletes this name-based extended MAC-IGMP access rule.
[no]{deny permit}{any-source-mac}{host-source-ma c<host_smac>}{<smac><smac-mask>} {any-destination-mac}{host-destination-mac <host_dmac>}{<dmac><dmac-mask>}tcp {<source><source-wildcard>}any-source {host-source<source-host-ip>} [s-port { <port1> range <sPortMin> <sPortMax> }] {<destination><destination-wildcard>}any-destinati on {host-destination <destination-host-ip>} [d-port { <port3> range <sPortMin> <sPortMax> }] [ack+fin+psh+rst+urg+syn] [precedence<precedence>][tos<tos>][time-range<ti	Creates an extended name-based MAC-TCP access rule; the “no” form command deletes this name-based extended MAC-TCP access rule.

me-range-name>]	
[no]{deny permit}{any-source-mac {host-source-mac<host_smac>}{<smac><smac-mask>}} {any-destination-mac {host-destination-mac<host_dmac>}{<dmac><dmac-mask>}}udp {{<source><source-wildcard>} any-source {host-source<source-host-ip>}} [s-port { <port1> range <sPortMin> <sPortMax> }] {{<destination><destination-wildcard>} any-destination {host-destination <destination-host-ip>}} [d-port { <port3> range <sPortMin> <sPortMax> }] [precedence <precedence>] [tos <tos>][time-range<time-range-name>]	Creates an extended name-based MAC-UDP access rule; the “no” form command deletes this name-based extended MAC-UDP access rule.
[no]{deny permit}{any-source-mac {host-source-mac<host_smac>}{<smac><smac-mask>}} {any-destination-mac {host-destination-mac<host_dmac>}{<dmac><dmac-mask>}} {eigrp gre igrp ip ipinip ospf {<protocol-num>}} {{<source><source-wildcard>} any-source {host-source<source-host-ip>}} {{<destination><destination-wildcard>} any-destination {host-destination<destination-host-ip>}} [precedence<precedence>][tos<tos>][time-range<time-range-name>]	Creates an extended name-based access rule for the other IP protocol; the “no” form command deletes this name-based extended access rule.

c. Exit MAC-IP Configuration Mode

Command	Explanation
Extended name-based MAC-IP access Mode	
exit	Quit extended name-based MAC-IP access mode.

(10) Configuring a numbered standard IPV6 access-list

Command	Explanation
Global Mode	
ipv6 access-list <num> {deny permit} {{<sIPv6Addr> <sPrefixlen>} any-source {host-source <slpv6Addr>}} no ipv6 access-list <num>	Creates a numbered standard IPV6 access-list, if the access-list already exists, then a rule will add to the current access-list; the “no access-list <num> ” command deletes a numbered standard IPV6 access-list.

(11) Configuring a numbered extensive IPV6 access-list

Command	Explanation
Global Mode	
<pre> ipv6 access-list <num-ext> {deny permit} icmp {{<sIPv6Prefix/sPrefixlen>} any-source {host-source <sIPv6Addr>}} {<dIPv6Prefix/dPrefixlen> any-destination {host-destination <dIPv6Addr>}} [<icmp-type> [<icmp-code>]] [dscp <dscp>] [flow-label <flowlabel>] [time-range <time-range-name>] </pre>	<p>Creates a numbered extended IPV6 access-list, if the access-list already exists, then a rule will add to the current access-list; the no ipv6 access-list <num> command deletes a numbered standard IPV6 access-list.</p>
<pre> ipv6 access-list <num-ext> {deny permit} tcp {{<sIPv6Prefix/<sPrefixlen>} any-source {host-source <sIPv6Addr>}} [s-port { <sPort> range <sPortMin> <sPortMax> }] {{< dIPv6Prefix/<dPrefixlen>} any-destination {host-destination <dIPv6Addr>}} [dPort { <dPort> range <sPortMin> <sPortMax> }] [syn ack urg rst fin psh] [dscp <dscp>] [flow-label <flowlabel>] [time-range <time-range-name>] </pre>	
<pre> ipv6 access-list <num-ext> {deny permit} udp {{<sIPv6Prefix/<sPrefixlen>} any-source {host-source <sIPv6Addr>}} [s-port { <sPort> range <sPortMin> <sPortMax> }] {{<dIPv6Prefix/<dPrefixlen>} any-destination {host-destination <dIPv6Addr>}} [dPort { <dPort> / range <sPortMin> <sPortMax> }] [dscp <dscp>] [flow-label <flowlabel>] [time-range <time-range-name>] </pre>	
<pre> ipv6 access-list <num-ext> {deny permit} <next-header> {<sIPv6Prefix/sPrefixlen> any-source {host-source <sIPv6Addr>}} {<dIPv6Prefix/dPrefixlen> any-destination {host-destination <dIPv6Addr>}} [dscp <dscp>] [flow-label <flowlabel>] [time-range <time-range-name>] </pre>	
no ipv6 access-list <num>	

(12) Configuring a standard IPV6 access-list based on nomenclature

a. Create a standard IPV6 access-list based on nomenclature

Command	Explanation
Global Mode	

ipv6 access-list standard <name> no ipv6 access-list standard <name>	Creates a standard IP access-list based on nomenclature; the no command delete the name-based standard IPV6 access-list.
---	---

b. Specify multiple permit or deny rules

Command	Explanation
Standard IPV6 ACL Mode	
[no] {deny permit} {{<sIPv6Prefix/sPrefixlen>} any-source {host-source <sIPv6Addr>}}	Creates a standard name-based IPV6 access rule; the no form command deletes the name-based standard IPV6 access rule.

c. Exit name-based standard IP ACL configuration mode

Command	Explanation
Standard IPV6 ACL Mode	
exit	Exits name-based standard IPV6 ACL configuration mode.

(13) Configuring an name-based extended IPV6 access-list

a. Create an extended IPV6 access-list basing on nomenclature

Command	Explanation
Global Mode	
ipv6 access-list extended <name> no ipv6 access-list extended <name>	Creates an extended IPV6 access-list basing on nomenclature; the no command deletes the name-based extended IPV6 access-list.

b. Specify multiple permit or deny rules

Command	Explanation
Extended IPV6 ACL Mode	
[no] {deny permit} icmp {{<sIPv6Prefix/sPrefixlen>} any-source {host-source <sIPv6Addr>}} {<dIPv6Prefix/dPrefixlen> any-destination {host-destination <dIPv6Addr>}} [<icmp-type> [<icmp-code>]] [dscp <dscp>] [flow-label <flowlabel>]	Creates an extended name-based ICMP IPv6 access rule; the no form command deletes this name-based extended IPV6

[time-range <time-range-name>]	access rule.
[no] {deny permit} tcp {<slIPv6Prefix/sPrefixlen> any-source {host-source <slIPv6Addr>}} [s-port { <sPort> range <sPortMin> <sPortMax> }] {<dIPv6Prefix/dPrefixlen> any-destination {host-destination <dIPv6Addr>}} [dPort { <dPort> range <sPortMin> <sPortMax> }] [syn ack urg rst fin psh] [dscp <dscp>] [flow-label <flowlabel>] [time-range <time-range-name>]	Creates an extended name-based TCP IPV6 access rule; the no form command deletes this name-based extended IPV6 access rule.
[no] {deny permit} udp {<slIPv6Prefix/sPrefixlen> any-source {host-source <slIPv6Addr>}} [s-port { <sPort> range <sPortMin> <sPortMax> }] {<dIPv6Prefix/dPrefixlen> any-destination {host-destination <dIPv6Addr>}} [d-port { <dPort> range <sPortMin> <sPortMax> }] [dscp <dscp>] [flow-label <flowlabel>] [time-range <time-range-name>]	Creates an extended name-based UDP IPV6 access rule; the no form command deletes this name-based extended IPV6 access rule..
[no] {deny permit} <proto> {<slIPv6Prefix/sPrefixlen> any-source {host-source <slIPv6Addr>}} {<dIPv6Prefix/dPrefixlen> any-destination {host-destination <dIPv6Addr>}} [dscp <dscp>] [flow-label <flowlabel>] [time-range <time-range-name>]	Creates an extended name-based IPV6 access rule for other IPV6 protocols; the no form command deletes this name-based extended IPV6 access rule.
[no] {deny permit} {<slIPv6Prefix/sPrefixlen> any-source {host-source <slIPv6Addr>}} {<dIPv6Prefix/dPrefixlen> any-destination {host-destination <dIPv6Addr>}} [dscp <dscp>] [flow-label <flowlabel>] [time-range <time-range-name>]	Creates an extended name-based IPV6 access rule; the no form command deletes this name-based extended IPV6 access rule.

c. Exit extended IPv6 ACL configuration mode

Command	Explanation
Extended IPV6 ACL Mode	
exit	Exits extended name-based IPV6 ACL configuration mode.

2. Configuring packet filtering function

(1) Enable global packet filtering function

Command	Explanation
Global Mode	
firewall enable	Enables global packet filtering function.
firewall disable	Disables global packet filtering function.

(2) Configure default action.

Command	Explanation
Global Mode	
firewall default {permit deny}[ipv4 ipv6 all]}	Sets default action to firewall.

3. Configuring time range function

(1) Create the name of the time range

Command	Explanation
Global Mode	
time-range <time_range_name>	Create a time range named time_range_name.
no time-range <time_range_name>	Stop the time range function named time_range_name.

(2) Configure periodic time range

Command	Explanation
Time range Mode	
absolute-periodic {Monday Tuesday Wednesday Thursday Friday Saturday Sunday} <start_time> to {Monday Tuesday Wednesday Thursday Friday Saturday Sunday} <end_time>	Configure the time range for the request of the week, and every week will run by the time range.
periodic {{Monday+Tuesday+Wednesday+Thursday+Friday+Saturday+Sunday} daily weekdays weekend} <start_time> to <end_time>	
[no] absolute-periodic {Monday Tuesday Wednesday Thursday Friday Saturday Sunday} <start_time> to {Monday Tuesday Wednesday Thursday Friday Saturday Sunday} <end_time>	Stop the function of the time range in the week.
[no] periodic {{Monday+Tuesday+Wednesday+Thursday+Friday+Saturday+Sunday} daily weekdays weekend} <start_time> to <end_time>	

(3) Configure absolute time range

Command	Explanation
Global Mode	
absolute start <start_time> <start_data> [end <end_time> <end_data>]	Configure absolute time range.
[no] absolute start <start_time> <start_data> [end <end_time> <end_data>]	Stop the function of the time range.

4. Bind access-list to a specific direction of the specified port.

Command	Explanation
Physical Port Mode, VLAN Port Mode	
{ip ipv6 mac mac-ip} access-group <acl-name> {in}[traffic-statistic] no {ip ipv6 mac mac-ip} access-group <acl-name> {in}	Physical interface mode: Applies an access-list to the specified direction on the port; the no command deletes the access-list bound to the port. VLAN interface mode: Applies an access-list to the specified direction on the port of VLAN; the no command deletes the access-list bound to the port of VLAN.

5. Clear the filtering information of the specified port

Command	Explanation
Admin Mode	
clear access-group statistic interface { <interface-name> ethernet <interface-name> }	Clear the filtering information of the specified port.

46.3 ACL Example

Scenario 1:

The user has the following configuration requirement: port 1/10 of the switch connects to 10.0.0.0/24 segment, ftp is not desired for the user.

Configuration description:

- 1 · Create a proper ACL
- 2 · Configuring packet filtering function

- 3 · Bind the ACL to the port

The configuration steps are listed below:

```
XGS3-42000R(config)#access-list 110 deny tcp 10.0.0.0 0.0.0.255 any-destination d-port 21
XGS3-42000R(config)#firewall enable
XGS3-42000R(config)#firewall default permit
XGS3-42000R(config)#interface ethernet 1/10
XGS3-42000R(config-If-Ethernet1/10)#ip access-group 110 in
XGS3-42000R(config-If-Ethernet1/10)#exit
XGS3-42000R(config)#exit
```

Configuration result:

```
XGS3-42000R#show firewall
Firewall status: enable.
Firewall default rule: permit.
XGS3-42000R#show access-lists
access-list 110(used 1 time(s))
access-list 110 deny tcp 10.0.0.0 0.0.0.255 any-destination d-port 21

XGS3-42000R#show access-group interface ethernet 1/10
interface name:Ethernet1/10
the ingress acl use in firewall is 110, traffic-statistics Disable.
```

Scenario 2:

The configuration requirement is stated as below: The switch should drop all the 802.3 datagram with 00-12-11-23-xx-xx as the source MAC address coming from interface 10.

Configuration description:

- 1 · Create the corresponding access list.
- 2 · Configure datagram filtering.
- 3 · Bind the ACL to the related interface.

The configuration steps are listed as below.

```
XGS3-42000R(config)#access-list 1100 deny 00-12-11-23-00-00 00-00-00-00-ff-ff any-destination-mac
untagged-802-3
XGS3-42000R(config)#access-list 1100 deny 00-12-11-23-00-00 00-00-00-00-ff-ff any tagged-802
XGS3-42000R(config)#firewall enable
XGS3-42000R(config)#firewall default permit
XGS3-42000R(config)#interface ethernet 1/10
XGS3-42000R(config-If-Ethernet1/10)#mac access-group 1100 in
XGS3-42000R(config-If-Ethernet1/10)#exit
XGS3-42000R(config)#exit
```

Configuration result:

```
XGS3-42000R#show firewall
  Firewall Status: Enable.
  Firewall Default Rule: Permit.
Switch #show access-lists
access-list 1100(used 1 time(s))
  access-list 1100 deny 00-12-11-23-00-00 00-00-00-00-ff-ff
any-destination-mac
  untagged-802-3
  access-list 1100 deny 00-12-11-23-00-00 00-00-00-00-ff-ff
any-destination-mac
Switch #show access-group interface ethernet 1/10
interface name:Ethernet1/10
  MAC Ingress access-list used is 1100,traffic-statistics Disable.
```

Scenario 3:

The configuration requirement is stated as below: The MAC address range of the network connected to the interface 10 of the switch is 00-12-11-23-xx-xx, and IP network is 10.0.0.0/24. FTP should be disabled and ping requests from outside network should be disabled.

Configuration description:

- 1 · Create the corresponding access list.
- 2 · Configure datagram filtering.
- 3 · Bind the ACL to the related interface.

The configuration steps are listed as below.

```
XGS3-42000R(config)#access-list 3110 deny 00-12-11-23-00-00 00-00-00-00-ff-ff any-destination-mac tcp
10.0.0.0 0.0.0.255 any-destination d-port 21
XGS3-42000R(config)#access-list 3110 deny any-source-mac 00-12-11-23-00-00 00-00-00-00-ff-ff icmp
any-source 10.0.0.0 0.0.0.255

XGS3-42000R(config)#firewall enable
XGS3-42000R(config)#firewall default permit
XGS3-42000R(config)#interface ethernet 1/10
XGS3-42000R(config-If-Ethernet1/10)#mac-ip access-group 3110 in
XGS3-42000R(config-Ethernet1/10)#exit
XGS3-42000R(config)#exit
```

Configuration result:

```
XGS3-42000R#show firewall
  Firewall Status: Enable.
  Firewall Default Rule: Permit.

XGS3-42000R#show access-lists
```

```
access-list 3110(used 1 time(s))
access-list 3110 deny 00-12-11-23-00-00 00-00-00-00-ff-ff
any-destination-mac
tcp 10.0.0.0 0.0.0.255 any-destination d-port 21
access-list 3110 deny any-source-mac 00-12-11-23-00-00 00-00-00-00-ff-ff icmp any-source 10.0.0.0
0.0.0.255

Switch #show access-group interface ethernet 1/10
interface name:Ethernet1/10
MAC-IP Ingress access-list used is 3110, traffic-statistics Disable.
```

Scenario 4:

The configuration requirement is stated as below: IPv6 protocol runs on the interface 600 of the switch. And the IPv6 network address is 2003:1:1:1::0/64. Users in the 2003:1:1:1:66::0/80 subnet should be disabled from accessing the outside network.

Configuration description:

- 1 · Create the corresponding access list.
- 2 · Configure datagram filtering.
- 3 · Bind the ACL to the related interface.

The configuration steps are listed as below.

```
XGS3-42000R(config)#ipv6 enable
XGS3-42000R(config)#ipv6 access-list 600 permit 2003:1:1:1:66::0/80 any-destination
XGS3-42000R(config)#ipv6 access-list 600 deny 2003:1:1:1::0/64 any-destination
XGS3-42000R(config)#firewall enable
XGS3-42000R(config)#firewall default permit
XGS3-42000R(config)#interface ethernet 1/10
XGS3-42000R(config-if-Ethernet1/10)#ipv6 access-group 600 in
XGS3-42000R(config-if-Ethernet1/10)#exit
XGS3-42000R(config)#exit
```

Configuration result:

```
XGS3-42000R#show firewall
Firewall Status: Enable.
Firewall Default Rule: Permit.

XGS3-42000R#show ipv6 access-lists
ipv6 access-list 600(used 1 time(s))
ipv6 access-list 600 deny 2003:1:1:1::0/64 any-source
ipv6 access-list 600 permit 2003:1:1:1:66::0/80 any-source

Switch #show access-group interface ethernet 1/10
```



```
interface name:Ethernet1/10
```

```
IPv6 Ingress access-list used is 600, traffic-statistics Disable.
```

Scenario 5:

The configuration requirement is stated as below: The interface 1, 2, 5, 7 belongs to vlan100, Hosts with 192.168.0.1 as its IP address should be disabled from accessing the listed interfaces.

Configuration description:

- 1 · Create the corresponding access list.
- 2 · Configure datagram filtering.
- 3 · Bind the ACL to the related interface.

The configuration steps are listed as below.

```
XGS3-42000R(config)#firewall enable
XGS3-42000R(config)#vlan 100
XGS3-42000R(Config-Vlan100)#switchport interface ethernet 1/1;2;5;7
XGS3-42000R(Config-Vlan100)#exit
XGS3-42000R(config)#access-list 1 deny host-source 192.168.0.1
XGS3-42000R(config)#interface vlan 100
XGS3-42000R(Config-if-Vlan100)#ip access-group 1 in
XGS3-42000R(Config-if-Vlan100)#exit
```

Configuration result:

```
XGS3-42000R(config)#show access-group interface vlan 100
Interface VLAN 100:
Ethernet1/1:  IP Ingress access-list used is 1, traffic-statistics Disable.
Ethernet1/2:  IP Ingress access-list used is 1, traffic-statistics Disable.
Ethernet1/5:  IP Ingress access-list used is 1, traffic-statistics Disable.
Ethernet1/7:  IP Ingress access-list used is 1, traffic-statistics Disable.
```

46.4 ACL Troubleshooting

- Checking for entries in the ACL is done in a top-down order and ends whenever an entry is matched.
- Default rule will be used only if no ACL is bound to the incoming direction of the port, or no ACL entry is matched.
- Each ingress port can bind one MAC-IP ACL, one IP ACL, one MAC ACL, one IPv6 ACL (via the physical interface mode or Vlan interface mode).
- When binding four ACL and packet matching several ACL at the same time, the priority relations are as follows in a top-down order. If the priority is same, then the priority of configuration at first is higher.
 - ◆ Ingress IPv6 ACL
 - ◆ Ingress MAC-IP ACL
 - ◆ Ingress IP ACL

◆ Ingress MAC ACL

- The number of ACLs that can be successfully bound depends on the content of the ACL bound and the hardware resource limit. Users will be prompted if an ACL cannot be bound due to hardware resource limitation.
- If an access-list contains same filtering information but conflicting action rules, binding to the port will fail with an error message. For instance, configuring “permit tcp any any-destination” and “deny tcp any any-destination” at the same time is not permitted.
- Viruses such as “worm.blaster” can be blocked by configuring ACL to block specific ICMP packets or specific TCP or UDP port packet.
- If the physical mode of an interface is TRUNK, ACL can only be configured through physical interface mode.
- ACL configured in the physical mode can only be disabled in the physical mode. Those configured in the VLAN interface configuration mode can only be disabled in the VLAN interface mode.
- When a physical interface is added into or removed from a VLAN (with the trunk interfaces as exceptions), ACL configured in the corresponding VLAN will be bound or unbound respectively. If ACL configured in the target VLAN, which is configured in VLAN interface mode, conflicts with existing ACL configuration on the interface, which is configured in physical interface mode, the configuration will fail to effect.
- When no physical interfaces are configured in the VLAN, the ACL configuration of the VLAN will be removed. And it can not recover if new interfaces are added to the VLAN.
- When the interface mode is changed from access mode to trunk mode, the ACL configured in VLAN interface mode which is bound to physical interface will be removed. And when the interface mode is changed from trunk mode to access mode, ACL configured in VLAN1 interface mode will be bound to the physical interface. If binding fails, the changing will fail either.
- When removing a VLAN configuration, if there are any ACLs bound to the VLAN, the ACL will be removed from all the physical interfaces belonging to the VLAN, and it will be bound to VLAN 1 ACL(if ACL is configured in VLAN1). If VLAN 1 ACL binding fails, the VLAN removal operation will fail..

Chapter 47 802.1x Configuration

47.1 Introduction to 802.1x

The 802.1x protocol originates from 802.11 protocol, the wireless LAN protocol of IEEE, which is designed to provide a solution to doing authentication when users access a wireless LAN. The LAN defined in IEEE 802 LAN protocol does not provide access authentication, which means as long as the users can access a LAN controlling device (such as a LAN Switch), they will be able to get all the devices or resources in the LAN. There was no looming danger in the environment of LAN in those primary enterprise networks.

However, along with the boom of applications like mobile office and service operating networks, the service providers should control and configure the access from user. The prevailing application of WLAN and LAN access in telecommunication networks, in particular, make it necessary to control ports in order to implement the user-level access control. And as a result, IEEE LAN/WAN committee defined a standard, which is 802.1x, to do Port-Based Network Access Control. This standard has been widely used in wireless LAN and ethernet.

“Port-Based Network Access Control” means to authenticate and control the user devices on the level of ports of LAN access devices. Only when the user devices connected to the ports pass the authentication, can they access the resources in the LAN, otherwise, the resources in the LAN won't be available.

47.1.1 The Authentication Structure of 802.1x

The system using 802.1x has a typical Client/Server structure, which contains three entities (as illustrated in the next figure): Supplicant system, Authenticator system, and Authentication server system.

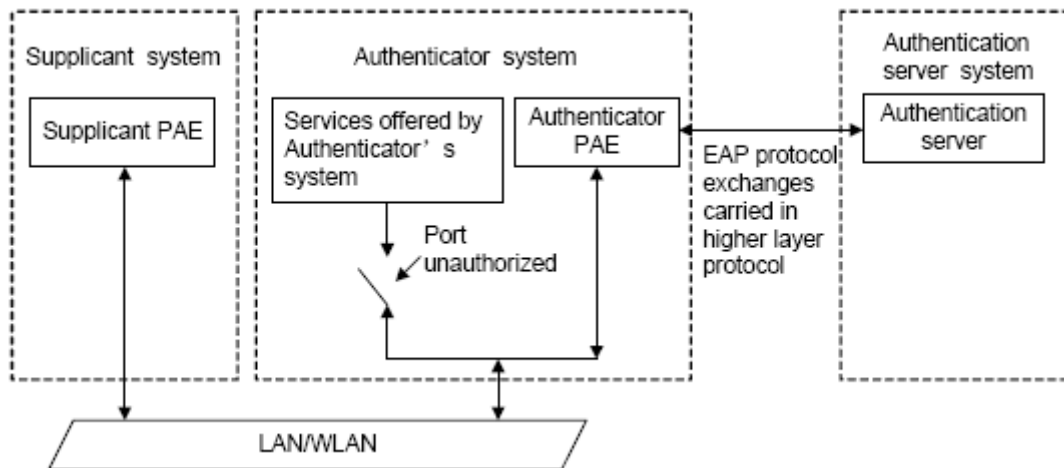

Figure 47-1-1 The Authentication Structure of 802.1x

- The supplicant system is an entity on one end of the LAN segment, should be authenticated by the access controlling unit on the other end of the link. A Supplicant system usually is a user terminal

device. Users start 802.1x authentication by starting supplicant system software. A supplicant system should support EAPOL (Extensible Authentication Protocol over LAN).

- The authenticator system is another entity on one end of the LAN segment to authenticate the supplicant systems connected. An authenticator system usually is a network device supporting 802.1x protocol, providing ports to access the LAN for supplicant systems. The ports provided can either be physical or logical.
- The authentication server system is an entity to provide authentication service for authenticator systems. The authentication server system is used to authenticate and authorize users, as well as does fee-counting, and usually is a RADIUS (Remote Authentication Dial-In User Service) server, which can store the relative user information, including username, password and other parameters such as the VLAN and ports which the user belongs to.

The three entities above concerns the following basic concepts: PAE of the port, the controlled ports and the controlled direction.

1. PAE

PAE (Port Access Entity) is the entity to implement the operation of algorithms and protocols.

- The PAE of the supplicant system is supposed to respond the authentication request from the authenticator systems and submit user's authentication information to the authenticator system. It can also send authentication request and off-line request to authenticator.
- The PAE of the authenticator system authenticates the supplicant systems needing to access the LAN via the authentication server system, and deal with the authenticated/unauthenticated state of the controlled port according to the result of the authentication. The authenticated state means the user is allowed to access the network resources, the unauthenticated state means only the EAPOL messages are allowed to be received and sent while the user is forbidden to access network resources.

2. controlled/uncontrolled ports

The authenticator system provides ports to access the LAN for the supplicant systems. These ports can be divided into two kinds of logical ports: controlled ports and uncontrolled ports.

- The uncontrolled port is always in bi-directionally connected status, and mainly used to transmit EAPOL protocol frames, to guarantee that the supplicant systems can always send or receive authentication messages.
- The controlled port is in connected status authenticated to transmit service messages. When unauthenticated, no message from supplicant systems is allowed to be received.
- The controlled and uncontrolled ports are two parts of one port, which means each frame reaching this port is visible on both the controlled and uncontrolled ports.

3. Controlled direction

In unauthenticated status, controlled ports can be set as unidirectional controlled or bi-directionally controlled.

- When the port is bi-directionally controlled, the sending and receiving of all frames is forbidden.
- When the port is unidirectional controlled, no frames can be received from the supplicant systems while sending frames to the supplicant systems is allowed.

Notes: At present, this kind of switch only supports unidirectional control.

47.1.2 The Work Mechanism of 802.1x

IEEE 802.1x authentication system uses EAP (Extensible Authentication Protocol) to implement exchange of authentication information between the supplicant system, authenticator system and authentication server system.

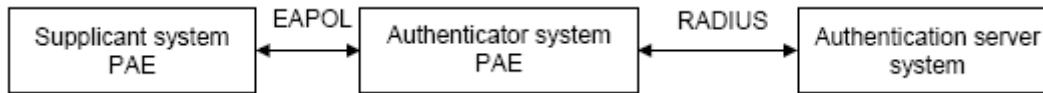

Figure 47-1-2 the Work Mechanism of 802.1x

- EAP messages adopt EAPOL encapsulation format between the PAE of the supplicant system and the PAE of the authenticator system in the environment of LAN.
- Between the PAE of the authenticator system and the RADIUS server, there are two methods to exchange information: one method is that EAP messages adopt EAPOR (EAP over RADIUS) encapsulation format in RADIUS protocol; the other is that EAP messages terminate with the PAE of the authenticator system, and adopt the messages containing RAP (Password Authentication Protocol) or CHAP (Challenge Handshake Authentication Protocol) attributes to do the authentication interaction with the RADIUS server.
- When the user pass the authentication, the authentication server system will send the relative information of the user to authenticator system, the PAE of the authenticator system will decide the authenticated/unauthenticated status of the controlled port according to the authentication result of the RADIUS server.

47.1.3 The Encapsulation of EAPOL Messages

1. The Format of EAPOL Data Packets

EAPOL is a kind of message encapsulation format defined in 802.1x protocol, and is mainly used to transmit EAP messages between the supplicant system and the authenticator system in order to allow the transmission of EAP messages through the LAN. In IEEE 802/Ethernet LAN environment, the format of EAPOL packet is illustrated in the next figure. The beginning of the EAPOL packet is the Type/Length domain in MAC frames.

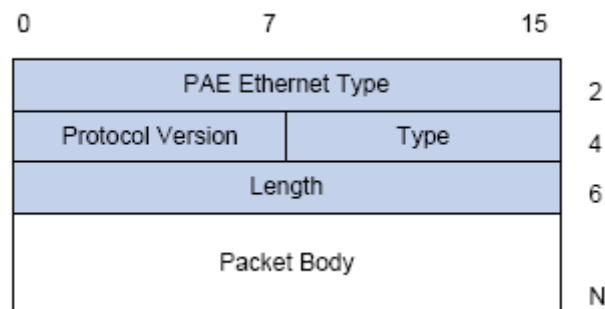

Figure 47-1-3 the Format of EAPOL Data Packet

PAE Ethernet Type: Represents the type of the protocol whose value is 0x888E.

Protocol Version: Represents the version of the protocol supported by the sender of EAPOL data packets.

Type: represents the type of the EAPOL data packets, including:

- EAP-Packet (whose value is 0x00): the authentication information frame, used to carry EAP messages. This kind of frame can pass through the authenticator system to transmit EAP messages between the supplicant system and the authentication server system.
- EAPOL-Start (whose value is 0x01): the frame to start authentication.
- EAPOL-Logoff (whose value is 0x02): the frame requesting to quit.
- EAPOL-Key (whose value is 0x03): the key information frame.
- EAPOL-Encapsulated-ASF-Alert (whose value is 0x04): used to support the Alerting messages of ASF (Alert Standard Forum). This kind of frame is used to encapsulate the relative information of network management such as all kinds of alerting information, terminated by terminal devices.

Length: represents the length of the data, that is, the length of the “Packet Body”, in byte. There will be no following data domain when its value is 0.

Packet Body: represents the content of the data, which will be in different formats according to different types.

2. The Format of EAP Data Packets

When the value of Type domain in EAPOL packet is EAP-Packet, the Packet Body is in EAP format (illustrated in the next figure).

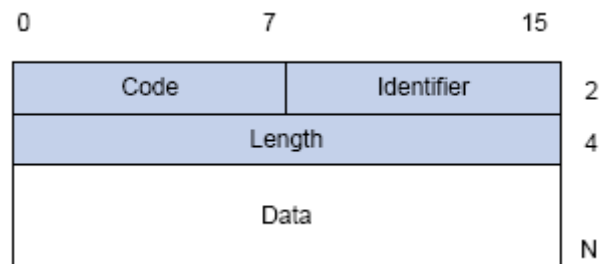

Figure 47-1-4 the Format of EAP Data Packets

Code: specifies the type of the EAP packet. There are four of them in total: Request (1), Response (2), Success (3), Failure (4).

- There is no Data domain in the packets of which the type is Success or Failure, and the value of the Length domains in such packets is 4.
- The format of Data domains in the packets of which the type is Request and Response is illustrated in the next figure. Type is the authentication type of EAP, the content of Type data depends on the type. For example, when the value of the type is 1, it means Identity, and is used to query the identity of the other side. When the type is 4, it means MD5-Challenge, like PPP CHAP protocol, contains query messages.

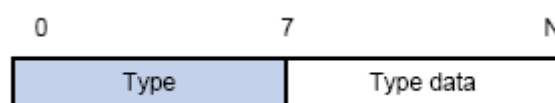

Figure 47-1-5 the Format of Data Domain in Request and Response Packets

Identifier: to assist matching the Request and Response messages.

Length: the length of the EAP packet, covering the domains of Code, Identifier, Length and Data, in byte.

Data: the content of the EAP packet, depending on the Code type.

47.1.4 The Encapsulation of EAP Attributes

RADIUS adds two attribute to support EAP authentication: EAP-Message and Message-Authenticator. Please refer to the Introduction of RADIUS protocol in “AAA-RADIUS-HWTACACS operation” to check the format of RADIUS messages.

1. EAP-Message

As illustrated in the next figure, this attribute is used to encapsulate EAP packet, the type code is 79, String domain should be no longer than 253 bytes. If the data length in an EAP packet is larger than 253 bytes, the packet can be divided into fragments, which then will be encapsulated in several EAP-Messages attributes in their original order.

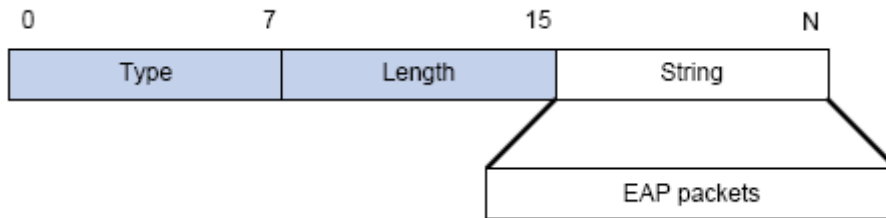

Figure 47-1-6 the Encapsulation of EAP-Message Attribute

2. Message-Authenticator

As illustrated in the next figure, this attribute is used in the process of using authentication methods like EAP and CHAP to prevent the access request packets from being eavesdropped. Message-Authenticator should be included in the packets containing the EAP-Message attribute, or the packet will be dropped as an invalid one.

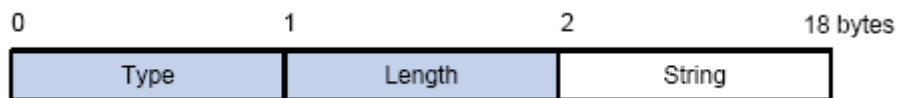

Figure 47-1-7 Message-Authenticator Attribute

47.1.5 Web Authentication Proxy based on 802.1x

The perspective of prior 802.1x authentication system abided by IEEE 802.1 x authentication systems on architecture, working mechanism, business processes. The client authentication pattern of prior authentication system privately. The devices are layer 2 switch and the authentication server is RADIUS server. EAP protocol is used for the authentication message pattern. EAPOL encapsulation is used between client and the authentication proxy switch, that is to say, EAP message is encapsulated in the Ethernet frame to authenticate and communicate, however, EAPOR encapsulation is used between authentication proxy switch and authentication server, that is to say, EAP message is loaded on the Radius protocol to authenticate and communicate. it can be also forward by the device, transmit the PAP protocol message or CHAP protocol message based on the RADIUS protocol between the device and the RADIUS sever.

In 802.1x authentication system, in order to implement the identity authentication and the network permission, user should install the authentication client software, pass client login authentication progress and then achieve authenticated communication with DCBI server. But some customers do not want to install client software, and they hope to authenticate by the internet explorer simplified. So in order to satisfy the new demand from the user and realize the platforms irrelevance of the authentication client, the Web authentication function based on 802.1x is designed for authentication.

The Web authentication is still based on IEEE 802.1x authentication system, the Java Applet in internet explorer is instead of the prior client software, the devises is layer 3 switch, authentication server is the standardized RADIUS server, and the authentication message is loaded in the EAP message to communicate. The Ethernet frame can't be send because of the Java Applet used in client, so EAP message can't be encapsulated in the Ethernet frame to send, EAP message should be loaded on the UDP protocol instead of EAPOU, in order to achieve the authentication and communication between web client and web authentication proxy switch. The standardized EAPOR protocol is still used between the authentication proxy switch and authentication server.

47.1.6 The Authentication Methods of 802.1x

The authentication can either be started by supplicant system initiatively or by devices. When the device detects unauthenticated users to access the network, it will send supplicant system EAP-Request/Identity messages to start authentication. On the other hand, the supplicant system can send EAPOL-Start message to the device via supplicant software.

802.1 x systems supports EAP relay method and EAP termination method to implement authentication with the remote RADIUS server. The following is the description of the process of these two authentication methods, both started by the supplicant system.

47.1.6.1 EAP Relay Mode

EAP relay is specified in IEEE 802.1x standard to carry EAP in other high-level protocols, such as EAP over RADIUS, making sure that extended authentication protocol messages can reach the authentication server through complicated networks. In general, EAP relay requires the RADIUS server to support EAP attributes: EAP-Message and Message-Authenticator.

EAP is a widely-used authentication frame to transmit the actual authentication protocol rather than a special authentication mechanism. EAP provides some common function and allows the authentication mechanisms expected in the negotiation, which are called EAP Method. The advantage of EAP lies in that EAP mechanism working as a base needs no adjustment when a new authentication protocol appears. The following figure illustrates the protocol stack of EAP authentication method.

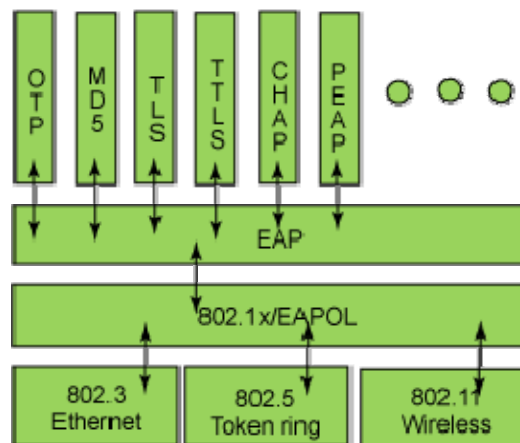

Figure 47-1-8 the Protocol Stack of EAP Authentication Method

By now, there are more than 50 EAP authentication methods has been developed, the differences among which are those in the authentication mechanism and the management of keys. The 4 most common EAP authentication methods are listed as follows:

- **EAP-MD5**
- **EAP-TLS** (Transport Layer Security)
- **EAP-TTLS** (Tunneled Transport Layer Security)
- **PEAP** (Protected Extensible Authentication Protocol)

They will be described in detail in the following part.

Attention:

- The switch, as the access controlling unit of Pass-through, will not check the content of a particular EAP method, so can support all the EAP methods above and all the EAP authentication methods that may be extended in the future.
- In EAP relay, if any authentication method in EAP-MD5, EAP-TLS, EAP-TTLS and PEAP is adopted, the authentication methods of the supplicant system and the RADIUS server should be the same.

1. EAP-MD5 Authentication Method

EAP-MD5 is an IETF open standard which providing the least security, since MD5 Hash function is vulnerable to dictionary attacks.

The following figure illustrated the basic operation flow of the EAP-MD5 authentication method.

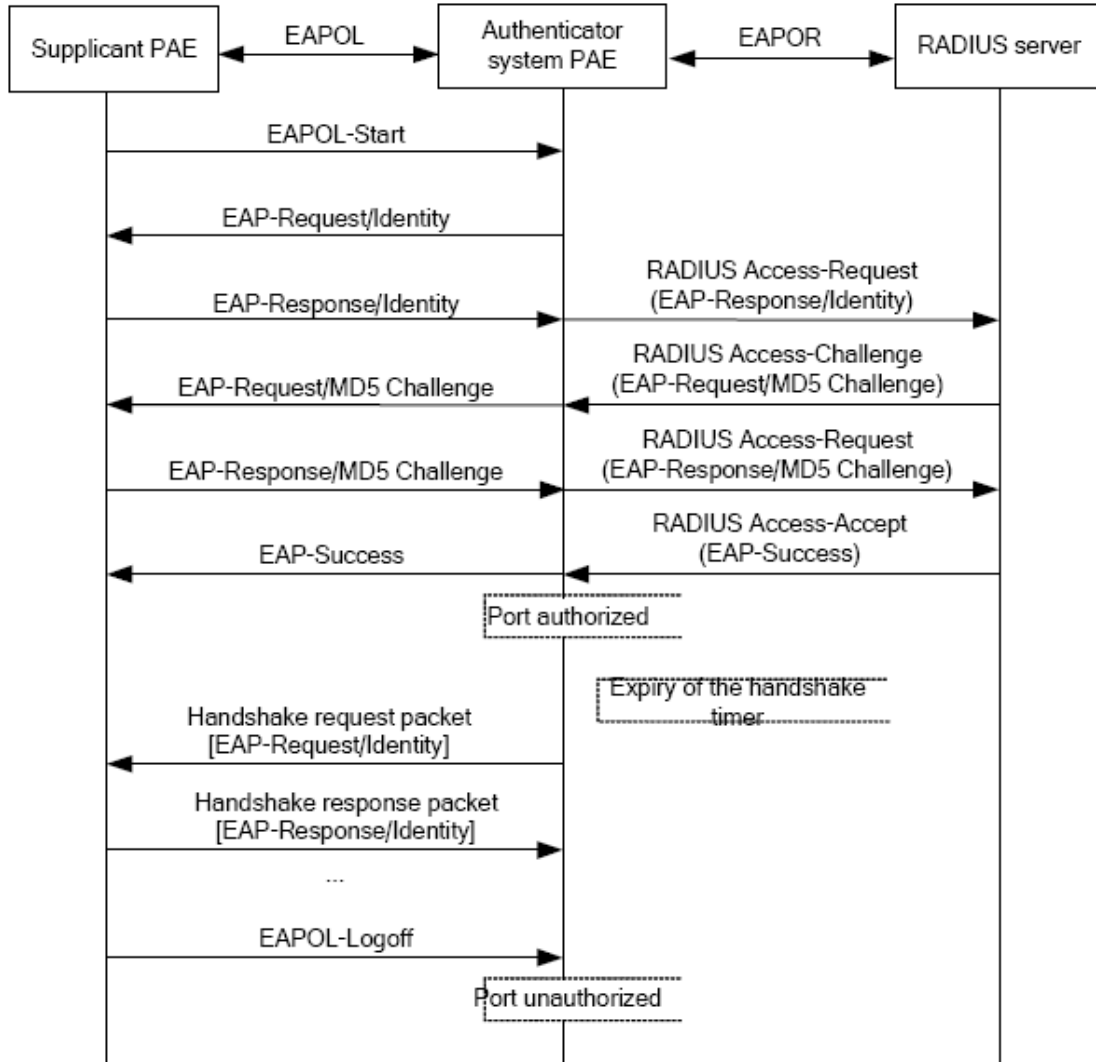

Figure 47-1-9 the Authentication Flow of 802.1x EAP-MD5

2. EAP-TLS Authentication Method

EAP-TLS is brought up by Microsoft based on EAP and TLS protocols. It uses PKI to protect the id authentication between the supplicant system and the RADIUS server and the dynamically generated session keys, requiring both the supplicant system and the Radius authentication server to possess digital certificate to implement bidirectional authentication. It is the earliest EAP authentication method used in wireless LAN. Since every user should have a digital certificate, this method is rarely used practically considering the difficult maintenance. However it is still one of the safest EAP standards, and enjoys prevailing supports from the vendors of wireless LAN hardware and software.

The following figure illustrates the basic operation flow of the EAP-TLS authentication method.

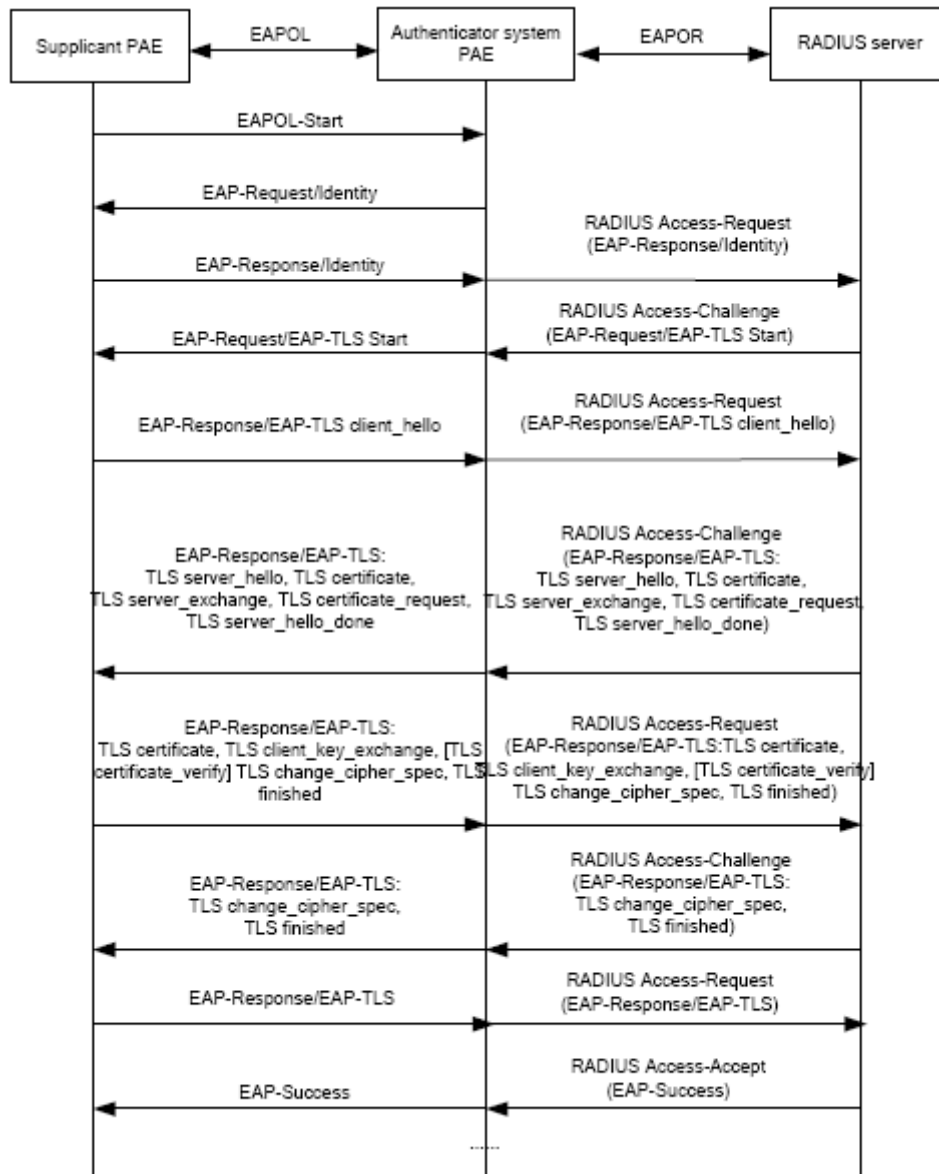

Figure 47-1-10 the Authentication Flow of 802.1x EAP-TLS

3. EAP-TTLS Authentication Method

EAP-TTLS is a product of the cooperation of Funk Software and Certicom. It can provide an authentication as strong as that provided by EAP-TLS, but without requiring users to have their own digital certificate. The only request is that the Radius server should have a digital certificate. The authentication of users' identity is implemented with passwords transmitted in a safely encrypted tunnel established via the certificate of the authentication server. Any kind of authentication request including EAP, PAP and MS-CHAPV2 can be transmitted within TTLS tunnels.

4. PEAP Authentication Method

EAP-PEAP is brought up by Cisco, Microsoft and RAS Security as a recommended open standard. It has long been utilized in products and provides very good security. Its design of protocol and security is similar to that of EAP-TTLS, using a server's PKI certificate to establish a safe TLS tunnel in order to protect user authentication.

The following figure illustrates the basic operation flow of PEAP authentication method.

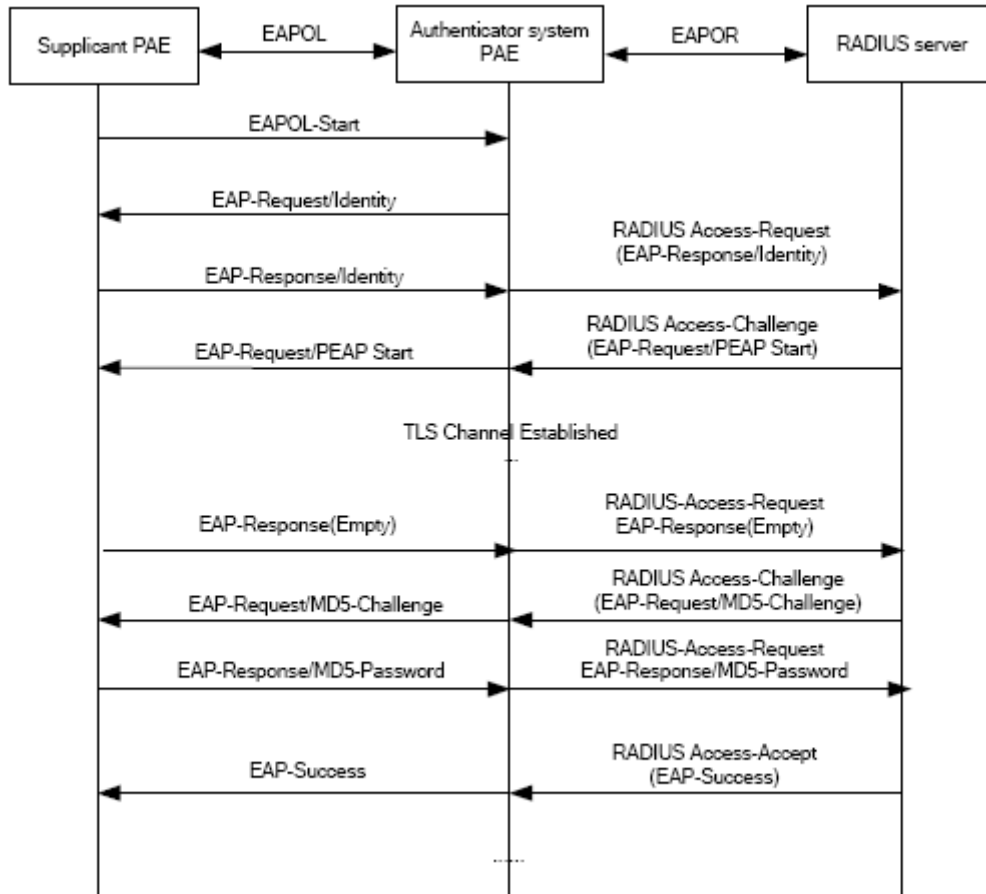

Figure 47-1-11 the Authentication Flow of 802.1x PEAP

47.1.6.2 EAP Termination Mode

In this mode, EAP messages will be terminated in the access control unit and mapped into RADIUS messages, which is used to implement the authentication, authorization and fee-counting. The basic operation flow is illustrated in the next figure.

In EAP termination mode, the access control unit and the RADIUS server can use PAP or CHAP authentication method. The following figure will demonstrate the basic operation flow using CHAP authentication method.

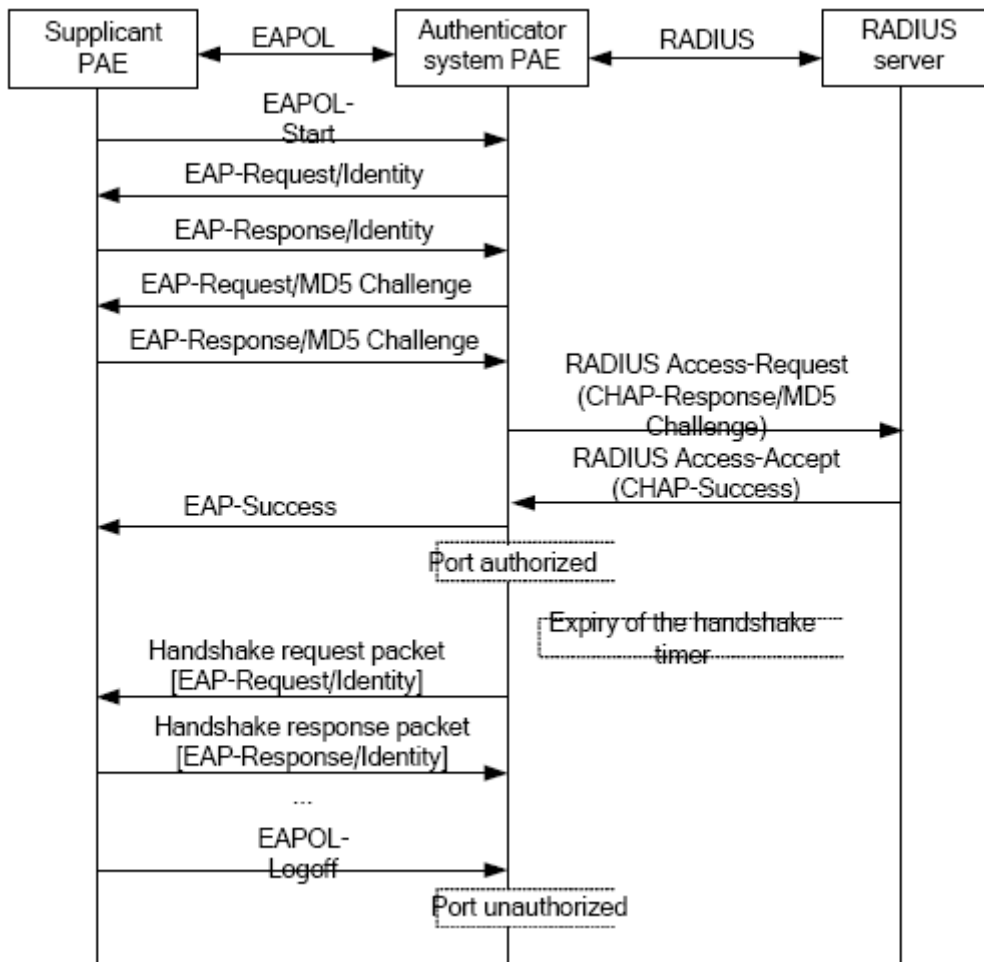

Figure 47-1-12 the Authentication Flow of 802.1x EAP Termination Mode

47.1.7 The Extension and Optimization of 802.1x

Besides supporting the port-based access authentication method specified by the protocol, devices also extend and optimize it when implementing the EAP relay mode and EAP termination mode of 802.1x.

- ◆ Supports some applications in the case of which one physical port can have more than one users
- ◆ There are three access control methods (the methods to authenticate users): port-based, MAC-based and user-based (IP address+ MAC address+ port).
 - When the port-based method is used, as long as the first user of this port passes the authentication, all the other users can access the network resources without being authenticated. However, once the first user is offline, the network won't be available to all the other users.
 - When the MAC-based method is used, all the users accessing a port should be authenticated separately, only those pass the authentication can access the network, while the others can not. When one user becomes offline, the other users will not be affected.
 - When the user-based (IP address+ MAC address+ port) method is used, all users can access limited resources before being authenticated. There are two kinds of control in this method: standard control and advanced control. The user-based standard control will not restrict the access to limited

resources, which means all users of this port can access limited resources before being authenticated. The user-based advanced control will restrict the access to limited resources, only some particular users of the port can access limited resources before being authenticated. Once those users pass the authentication, they can access all resources.

Attention: when using private supplicant systems, user-based advanced control is recommended to effectively prevent ARP cheat.

The maximum number of the authenticated users can be 4000, but less than 2000 will be preferred.

47.1.8 The Features of VLAN Allocation

1. Auto VLAN

Auto VLAN feature enables RADIUS server to change the VLAN to which the access port belongs, based on the user information and the user access device information. When an 802.1x user passes authentication on the server, the RADIUS server will send the authorization information to the device, if the RADIUS server has enabled the VLAN-assigning function, then the following attributes should be included in the Access-Accept messages:

- Tunnel-Type = VLAN (13)
- Tunnel-Medium-Type = 802 (6)
- Tunnel-Private-Group-ID = VLANID

The VLANID here means the VID of VLAN, ranging from 1 to 4094. For example, Tunnel-Private-Group-ID = 30 means VLAN 30.

When the switch receives the assigned Auto VLAN information, the current Access port will leave the VLAN set by the user and join Auto VLAN.

Auto VLAN won't change or affect the port's configuration. But the priority of Auto VLAN is higher than that of the user-set VLAN, that is Auto VLAN is the one takes effect when the authentication is finished, while the user-set VLAN do not work until the user become offline.

Notes: At present, Auto VLAN can only be used in the port-based access control mode, and on the ports whose link type is Access.

2. Guest VLAN

Guest VLAN feature is used to allow the unauthenticated user to access some specified resources.

The user authentication port belongs to a default VLAN (Guest VLAN) before passing the 802.1x authentication, with the right to access the resources within this VLAN without authentication. But the resources in other networks are beyond reach. Once authenticated, the port will leave Guest VLAN, and the user can access the resources of other networks.

In Guest VLAN, users can get 802.1x supplicant system software, update supplicant system or update some other applications (such as anti-virus software, the patches of operating system). The access device will add the port into Guest VLAN if there is no supplicant getting authenticated successfully in a certain stretch of time because of lacking exclusive authentication supplicant system or the version of the supplicant system being too low.

Once the 802.1x feature is enabled and the Guest VLAN is configured properly, a port will be added into Guest VLAN, just like Auto VLAN, if there is no response message from the supplicant system after the device sends more authentication-triggering messages than the upper limit (EAP-Request/Identity) from the port.

- The authentication server assigns an Auto VLAN, and then the port leaves Guest VLAN and joins the assigned Auto VLAN. When the user becomes offline, the port will be allocated to the specified Guest VLAN again.
- The authentication server assigns an Auto VLAN, and then the port leaves Guest VLAN and joins the specified VLAN. When the user becomes offline, the port will be allocated to the specified Guest VLAN again.

47.2 802.1x Configuration Task List

802.1x Configuration Task List:

1. Enable IEEE 802.1x function
2. Configure web authentication agent function
3. Access management unit property configuration
 - 1) Configure port authentication status
 - 2) Configure access management method for the port: MAC-based or port-based.
 - 3) Configure expanded 802.1x function
 - 4) Configure IPv6 passthrough function of the port
4. User access devices related property configuration (optional)

1. Enable 802.1x function

Command	Explanation
Global Mode	
dot1x enable no dot1x enable	Enables the 802.1x function in the switch and ports; the no command disables the 802.1x function.
dot1x privateclient enable no dot1x privateclient enable	Enables the switch force client software using private 802.1x authentication packet format. The no command will disable this function.
dot1x user free-resource <prefix> <mask> no dot1x user free-resource	Sets free access network resource for unauthorized dot1x user. The no command close the resource.

2. Configure Web authentication agent function

Command	Explanation
Global Mode	
dot1x web authentication enable no dot1x web authentication enable	Enable Web authentication agent, the no command disable Web authentication agent.
dot1x web redirect <URL> no dot1x web redirect	Set the HTTP server address for Web redirection, the no command clears the address.

3. Access management unit property configuration

1) Configure port authentication status

Command	Explanation
Port Mode	
dot1x port-control {auto force-authorized force-unauthorized } no dot1x port-control	Sets the 802.1x authentication mode; the no command restores the default setting.

2) Configure port access management method

Command	Explanation
Port Mode	
dot1x port-method {macbased portbased webbased userbased advanced} no dot1x port-method	Sets the port access management method; the no command restores MAC-based access management.
dot1x max-user macbased <number> no dot1x max-user macbased	Sets the maximum number of access users for the specified port; the no command restores the default setting of allowing 1 user.
dot1x max-user userbased <number> no dot1x max-user userbased	Set the upper limit of the number of users allowed accessing the specified port, only used when the access control mode of the port is userbased; the no command is used to reset the limit to 10 by default.
dot1x guest-vlan <vlanID> no dot1x guest-vlan	Set the guest vlan of the specified port; the no command is used to delete the guest vlan.

3) Configure expanded 802.1x function

Command	Explanation
Global Mode	
dot1x macfilter enable no dot1x macfilter enable	Enables the 802.1x address filter function in the switch; the no command disables the 802.1x address filter function.
dot1x accept-mac <mac-address> [interface <interface-name>] no dot1x accept-mac <mac-address> [interface <interface-name>]	Adds 802.1x address filter table entry, the no command deletes 802.1x filter address table entries.
dot1x eapor enable no dot1x eapor enable	Enables the EAP relay authentication function in the switch; the no command sets EAP local end authentication.

4) Configure IPv6 passthrough function of the port

Command	Explanation
Global Mode	
dot1x ipv6 passthrough no dot1x ipv6 passthrough	Enables IPv6 passthrough function of global mode on a switch, only applicable when access control mode is userbased; the no operation of this command will disable the function.

4. Supplicant related property configuration

Command	Explanation
Global Mode	
dot1x max-req <count> no dot1x max-req	Sets the number of EAP request/MD5 frame to be sent before the switch re-initials authentication on no supplicant response, the no command restores the default setting.
dot1x re-authentication no dot1x re-authentication	Enables periodical supplicant authentication; the no command disables this function.
dot1x timeout quiet-period <seconds> no dot1x timeout quiet-period	Sets time to keep silent on port authentication failure; the no command restores the default value.
dot1x timeout re-authperiod <seconds> no dot1x timeout re-authperiod	Sets the supplicant re-authentication interval; the no command restores the default setting.
dot1x timeout tx-period <seconds> no dot1x timeout tx-period	Sets the interval for the supplicant to re-transmit EAP request/identity frame; the no command restores the default setting.
dot1x re-authenticate [interface <interface-name>]	Enables IEEE 802.1x re-authentication (no wait timeout requires) for all ports or a specified port.

47.3 802.1x Application Example

47.3.1 Examples of Guest Vlan Applications

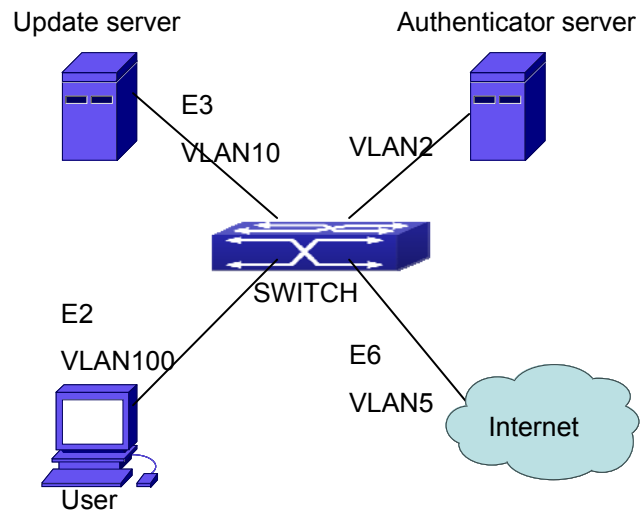

Figure 47-3-1 The Network Topology of Guest VLAN

Notes: in the figures in this session, E2 means Ethernet 1/2, E3 means Ethernet 1/3 and E6 means Ethernet 1/6.

As showed in the next figure, a switch accesses the network using 802.1x authentication, with a RADIUS server as its authentication server. Ethernet1/2, the port through which the user accesses the switch belongs to VLAN100; the authentication server is in VLAN2; Update Server, being in VLAN10, is for the user to download and update supplicant system software; Ethernet1/6, the port used by the switch to access the Internet is in VLAN5.

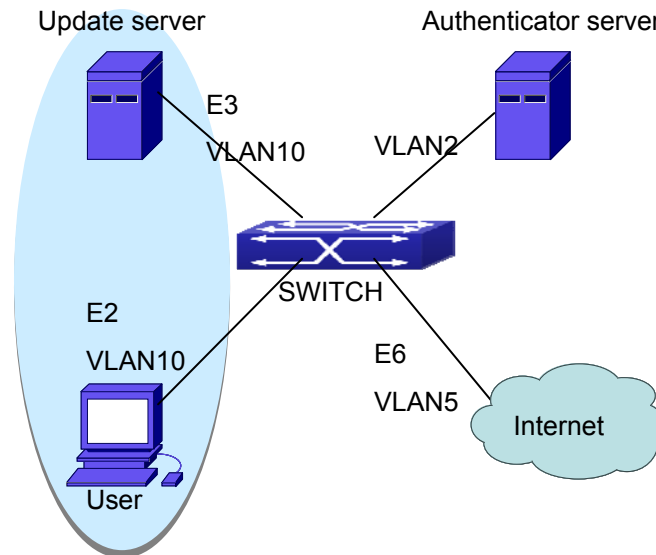

Figure 2-14 User Joining Guest VLAN

As illustrated in the up figure, on the switch port Ethernet1/2, the 802.1x feature is enabled, and the VLAN10 is set as the port's Guest VLAN. Before the user gets authenticated or when the user fails to do so, port Ethernet1/2 is added into VLAN10, allowing the user to access the Update Server.

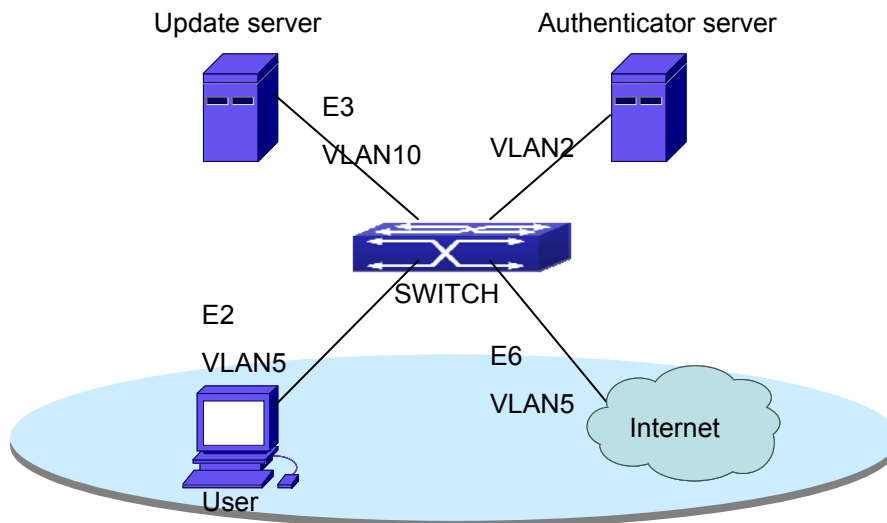

Figure 47-3-2 User Being Online, VLAN Being Offline

As illustrated in the up figure, when the users become online after a successful authentication, the authentication server will assign VLAN5, which makes the user and Ethernet1/6 both in VLAN5, allowing the user to access the Internet.

The following are configuration steps:

```
# Configure RADIUS server.
XGS3-42000R(config)#radius-server authentication host 10.1.1.3
XGS3-42000R(config)#radius-server accounting host 10.1.1.3
XGS3-42000R(config)#radius-server key test
XGS3-42000R(config)#aaa enable
XGS3-42000R(config)#aaa-accounting enable

# Create VLAN100.
XGS3-42000R(config)#vlan 100

# Enable the global 802.1x function
XGS3-42000R(config)#dot1x enable

# Enable the 802.1x function on port Ethernet1/2
XGS3-42000R(config)#interface ethernet1/2
XGS3-42000R(config-if-Ethernet1/2)#dot1x enable

# Set the link type of the port as access mode.
XGS3-42000R(config-if-Ethernet1/2)#switch-port mode access

# Set the access control mode on the port as portbased.
XGS3-42000R(config-if-Ethernet1/2)#dot1x port-method portbased

# Set the access control mode on the port as auto.
XGS3-42000R(config-if-Ethernet1/2)#dot1x port-control auto

# Set the port's Guest VLAN as 100.
XGS3-42000R(config-if-Ethernet1/2)#dot1x guest-vlan 100
XGS3-42000R(config-if-Ethernet1/2)#exit
```

Using the command of **show running-config** or **show interface ethernet 1/2**, users can check the configuration of Guest VLAN. When there is no online user, no failed user authentication or no user gets offline successfully, and more authentication-triggering messages (EAP-Request/Identity) are sent than the upper limit defined, users can check whether the Guest VLAN configured on the port takes effect with the command **show vlan id 100**.

47.3.2 Examples of IPv4 Radius Applications

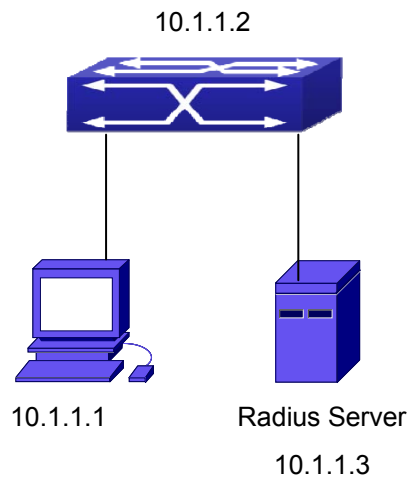

Figure 47-3-3 IEEE 802.1x Configuration Example Topology

The PC is connecting to port 1/2 of the switch; IEEE 802.1x authentication is enabled on port1/2; the access mode is the default MAC-based authentication. The switch IP address is 10.1.1.2. Any port other than port 1/2 is used to connect to RADIUS authentication server, which has an IP address of 10.1.1.3, and use the default port 1812 for authentication and port 1813 for accounting. IEEE 802.1x authentication client software is installed on the PC and is used in IEEE 802.1x authentication.

The configuration procedures are listed below:

```
XGS3-42000R(config)#interface vlan 1
XGS3-42000R(config-if-vlan1)#ip address 10.1.1.2 255.255.255.0
XGS3-42000R(config-if-vlan1)#exit
XGS3-42000R(config)#radius-server authentication host 10.1.1.3
XGS3-42000R(config)#radius-server accounting host 10.1.1.3
XGS3-42000R(config)#radius-server key test
XGS3-42000R(config)#aaa enable
XGS3-42000R(config)#aaa-accounting enable
XGS3-42000R(config)#dot1x enable
XGS3-42000R(config)#interface ethernet 1/2
XGS3-42000R(config-if-Ethernet1/2)#dot1x enable
XGS3-42000R(config-if-Ethernet1/2)#dot1x port-control auto
XGS3-42000R(config-if-Ethernet1/2)#exit
```

47.3.3 Examples of IPv6 Radius Application

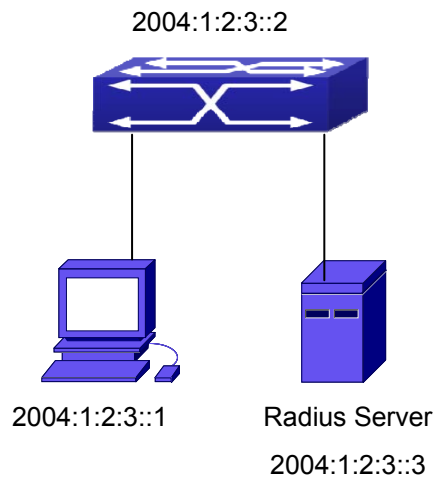

Figure 47-3-4 IPv6 Radius

Connect the computer to the interface 1/2 of the switch, and enable IEEE802.1x on interface1/2. Use MAC based authentication. Configure the IP address of the switch as 2004:1:2:3::2, and connect the switch with any interface except interface 1/2 to the RADIUS authentication server. Configure the IP address of the RADIUS server to be 2004:1:2:3::3. Use the default ports 1812 and 1813 for authentication and accounting respectively. Install the IEEE802.1x authentication client software on the computer, and use the client for IEEE802.1x authentication.

The detailed configurations are listed as below:

```
XGS3-42000R(config)#interface vlan 1
XGS3-42000R(config-if-vlan1)#ipv6 address 2004:1:2:3::2/64
XGS3-42000R(config-if-vlan1)#exit
XGS3-42000R(config)#radius-server authentication host 2004:1:2:3::3
XGS3-42000R(config)#radius-server accounting host 2004:1:2:3::3
XGS3-42000R(config)#radius-server key test
XGS3-42000R(config)#aaa enable
XGS3-42000R(config)#aaa-accounting enable
XGS3-42000R(config)#dot1x enable
XGS3-42000R(config)#interface ethernet 1/2
XGS3-42000R(config-if-Ethernet1/2)#dot1x enable
XGS3-42000R(config-if-Ethernet1/2)#dot1x port-control auto
XGS3-42000R(config-if-Ethernet1/2)#exit
```

47.3.4 802.1x Web Proxy Authentication Sample Application

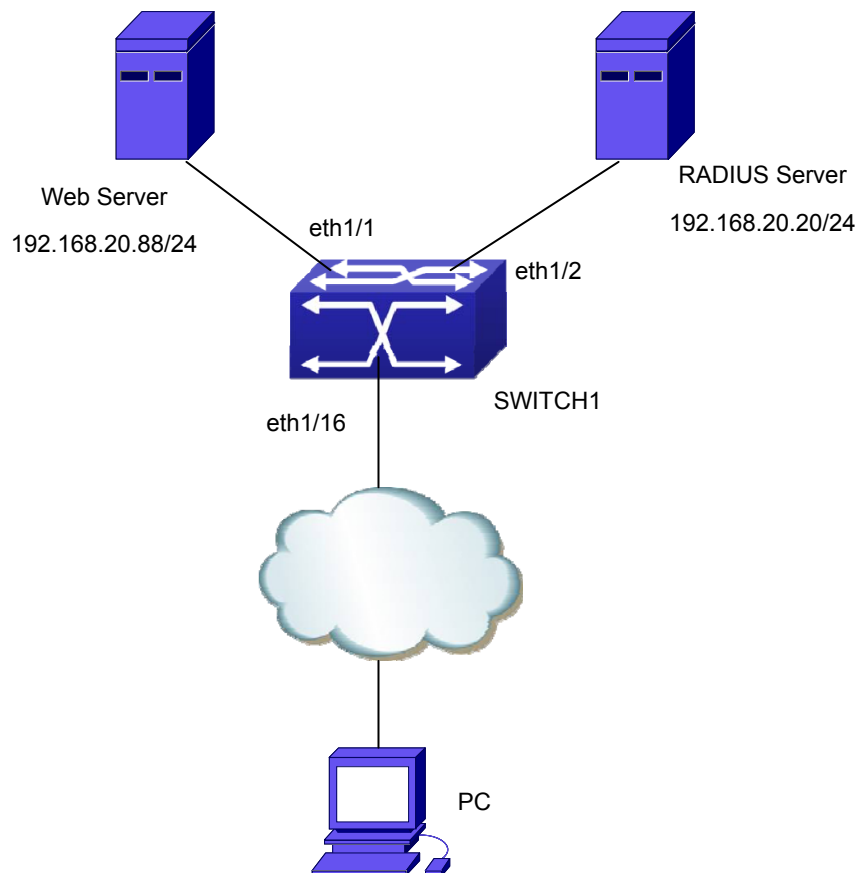

Figure 47-3-5 802.1x Web Proxy Authentication

In the network topology shown as above, Ethernet 1/1 on SWITCH1 is connected to the Web server whose IP address is 192.168.20.20/24, Ethernet 1/2 on SWITCH1 is connected to the RADIUS server whose IP address is 192.168.20.88/24 and authentication port is 1812. PC is connected to Ethernet 1/16 on SWITCH1 through an unknown network. The Web server and the authentication server are connected to VLAN 1, while PC is connected to VLAN 2. 802.1x Web authentication can be enabled through the following configuration. The re-authentication function is disabled by default. To enable this, corresponding 802.1x configuration should be issued first.

Configuration task list on SWITCH1

```
XGS3-42000R(config)#dot1x enable
XGS3-42000R(config)#dot1x web authentication enable
XGS3-42000R(config)#dot1x web redirect http://192.168.20.20/WebSupplicant/
XGS3-42000R(config)#interface ethernet 1/16
XGS3-42000R(config-If-Ethernet1/16)#dot1x enable
XGS3-42000R(config-If-Ethernet1/16)#dot1x port-method webbased
```

47.4 802.1x Troubleshooting

- It is possible that 802.1x be configured on ports and 802.1x authentication be set to auto, t switch can't be to authenticated state after the user runs 802.1x supplicant software. Here are some possible causes and solutions:
- If 802.1x cannot be enabled for a port, make sure the port is not executing MAC binding, or configured as a port aggregation. To enable the 802.1x authentication, the above functions must be disabled.
- If the switch is configured properly but still cannot pass through authentication, connectivity between the switch and RADIUS server, the switch and 802.1x client should be verified, and the port and VLAN configuration for the switch should be checked, too.
- Check the event log in the RADIUS server for possible causes. In the event log, not only unsuccessful logins are recorded, but prompts for the causes of unsuccessful login. If the event log indicates wrong authenticator password, radius-server key parameter shall be modified; if the event log indicates no such authenticator, the authenticator needs to be added to the RADIUS server; if the event log indicates no such login user, the user login ID and password may be wrong and should be verified and input again.
- Web Authentication Proxy based on 802.1x is disabled by default. Open the debug dot1x switch to check debugging information when the Web Authentication Proxy based on 802.1x is opened.
- If the state display of the port is not disabled when use show dot1x, that means the Web Authentication Proxy function based on 802.1x is not close it.
- The switch of the Web Authentication Proxy based on 802.1x achieves less than 1024 users who had authenticated simultaneity on line. If exceeds this limit will return hint information.
- When the Web Authentication is failed should check whether the dot1x privateclient enable command is enabled, if the command had been enabled, then the private authentication function need close.

Chapter 48 The Number Limitation Function of Port, MAC in VLAN and IP Configuration

48.1 Introduction to the Number Limitation Function of Port, MAC in VLAN and IP

MAC address list is used to identify the mapping relationship between the destination MAC addresses and the ports of switch. There are two kinds of MAC addresses in the list: static MAC address and dynamic MAC address. The static MAC address is set by users, having the highest priority (will not be overwritten by dynamic MAC address), and will always be effective; dynamic MAC address is learnt by the switch through transmitting data frames, and will only be effective in a specific time range. When the switch receives a data framed waiting to be transmitted, it will study the source MAC address of the data frame, build a mapping relationship with the receiving port, and then look up the MAC address list for the destination MAC address. If any matching list entry is found, the switch will transmit the data frame via the corresponding port, or, the switch will broadcast the data frame over the VLAN it belongs to. If the dynamically learnt MAC address matches no transmitted data in a long time, the switch will delete it from the MAC address list.

Usually the switch supports both the static configuration and dynamic study of MAC address, which means each port can have more than one static set MAC addresses and dynamically learnt MAC addresses, and thus can implement the transmission of data traffic between port and known MAC addresses. When a MAC address becomes out of date, it will be dealt with broadcast. No number limitation is put on MAC address of the ports of our current switches; every port can have several MAC addressed either by configuration or study, until the hardware list entries are exhausted. To avoid too many MAC addresses of a port, we should limit the number of MAC addresses a port can have.

For each INTERFACE VLAN, there is no number limitation of IP; the upper limit of the number of IP is the upper limit of the number of user on an interface, which is, at the same time, the upper limit of ARP and ND list entry. There is no relative configuration command can be used to control the sent number of these list entries. To enhance the security and the controllability of our products, we need to control the number of MAC address on each port and the number of ARP, ND on each INTERFACE VLAN. The number of static or dynamic MAC address on a port should not exceed the configuration. The number of user on each VLAN should not exceed the configuration, either.

Limiting the number of MAC and ARP list entry can avoid DOS attack to a certain extent. When malicious users frequently do MAC or ARP cheating, it will be easy for them to fill the MAC and ARP list entries of the switch, causing successful DOS attacks.

To summer up, it is very meaningful to develop the number limitation function of port, MAC in VLAN and IP. Switch can control the number of MAC address of ports and the number ARP, ND list entry of ports and VLAN through configuration commands.

Limiting the number of dynamic MAC and IP of ports:

1. Limiting the number of dynamic MAC. If the number of dynamically learnt MAC address by the switch is already larger than or equal with the max number of dynamic MAC address, then shutdown the MAC study function on this port, otherwise, the port can continue its study.
2. Limiting the number of dynamic IP. If the number of dynamically learnt ARP and ND by the switch is already larger than or equal with the max number of dynamic ARP and ND, then shutdown the ARP and ND study function of this port, otherwise, the port can continue its study.

Limiting the number of MAC, ARP and ND of interfaces:

1. Limiting the number of dynamic MAC. If the number of dynamically learnt MAC address by the VLAN of the switch is already larger than or equal with the max number of dynamic MAC address, then shutdown the MAC study function of all the ports in this VLAN, otherwise, all the ports in this VLAN can continue their study (except special ports).
2. Limiting the number of dynamic IP. If the number of dynamically learnt ARP and ND by the switch is already larger than or equal with the max number of dynamic ARP and ND, then the VLAN will not study any new ARP or ND, otherwise, the study can be continued.

48.2 The Number Limitation Function of Port, MAC in VLAN and IP Configuration Task Sequence

1. Enable the number limitation function of MAC 、IP on ports
2. Enable the number limitation function of MAC 、IP in VLAN
3. Configure the timeout value of querying dynamic MAC
4. Display and debug the relative information of number limitation of MAC 、IP on ports

1 · Enable the number limitation function of MAC 、IP on ports

Command	Explanation
Port configuration mode	
switchport mac-address dynamic maximum <value> no switchport mac-address dynamic maximum	Enable and disable the number limitation function of MAC on the ports.
switchport arp dynamic maximum <value> no switchport arp dynamic maximum	Enable and disable the number limitation function of ARP on the ports.
switchport nd dynamic maximum <value> no switchport nd dynamic maximum	Enable and disable the number limitation function of ND on the ports.

2 · Enable the number limitation function of MAC 、IP in VLAN

Command	Explanation
VLAN configuration mode	
vlan mac-address dynamic maximum <value> no vlan mac-address dynamic maximum	Enable and disable the number limitation function of MAC in the VLAN.
Interface configuration mode	
ip arp dynamic maximum <value> no ip arp dynamic maximum	Enable and disable the number limitation function of ARP in the VLAN.
ipv6 nd dynamic maximum <value> no ipv6 nd dynamic maximum	Enable and disable the number limitation function of NEIGHBOR in the VLAN.

3 · Configure the timeout value of querying dynamic MAC.

Command	Explanation
Global configuration mode	
mac-address query timeout <seconds>	Configure the timeout value of querying dynamic MAC.

4 · Display and debug the relative information of number limitation of MAC 、IP on ports

Command	Explanation
Admin mode	
show mac-address dynamic count {vlan <vlan-id> interface ethernet <portName> }	Display the number of dynamic MAC in corresponding ports and VLAN.
show arp-dynamic count {vlan <vlan-id> interface ethernet <portName> }	Display the number of dynamic ARP in corresponding ports and VLAN.
show nd-dynamic count {vlan <vlan-id> interface ethernet <portName> }	Display the number of dynamic NEIGHBOUR in corresponding ports and VLAN.
debug switchport mac count no debug switchport mac count	All kinds of debug information when limiting the number of MAC on ports.
debug switchport arp count no debug switchport arp count	All kinds of debug information when limiting the number of ARP on ports.
debug switchport nd count no debug switchport nd count	All kinds of debug information when limiting the number of NEIGHBOUR on ports.
debug vlan mac count no debug vlan mac count	All kinds of debug information when limiting the number of MAC in VLAN.

debug ip arp count no debug ip arp count	All kinds of debug information when limiting the number of ARP in VLAN.
debug ipv6 nd count no debug ipv6 nd count	All kinds of debug information when limiting the number of MAC in VLAN.

48.3 The Number Limitation Function of Port, MAC in VLAN and IP Typical Examples

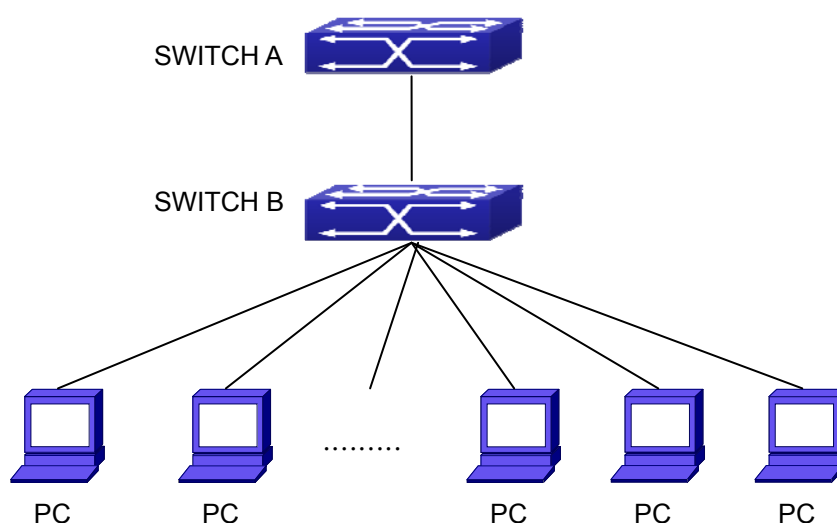

Figure 48-3-1 The Number Limitation of Port, MAC in VLAN and IP Typical Configuration Example

In the network topology above, SWITCH B connects to many PC users, before enabling the number limitation function of port, MAC in VLAN and IP, if the system hardware has no other limitation, SWITCH A and SWITCH B can get the MAC, ARP, ND list entries of all the PC, so limiting the MAC, ARP list entry can avoid DOS attack to a certain extent. When malicious users frequently do MAC, ARP cheating, it will be easy for them to fill the MAC, ARP list entries of the switch, causing successful DOS attacks. Limiting the MAC, ARP, ND list entry can prevent DOS attack.

On port 1/1 of SWITCH A, set the max number can be learnt of dynamic MAC address as 20, of dynamic ARP address as 20, NEIGHBOR list entry as 10. In VLAN 1, set the max number of dynamic MAC address as 30, of dynamic ARP address as 30, NEIGHBOR list entry as 20.

SWITCH A configuration task sequence:

```
XGS3-42000R(config)#interface ethernet 1/1
XGS3-42000R(Config-If-Ethernet1/1)#switchport mac-address dynamic maximum 20
XGS3-42000R(Config-If-Ethernet1/1)#switchport arp dynamic maximum 20
XGS3-42000R(Config-If-Ethernet1/1)#switchport nd dynamic maximum 10
XGS3-42000R(Config-if-Vlan1)#vlan mac-address dynamic maximum 30
```

48.4 The Number Limitation Function of Port, MAC in VLAN and IP Troubleshooting Help

The number limitation function of port, MAC in VLAN and IP is disabled by default, if users need to limit the number of user accessing the network, they can enable it. If the number limitation function of MAC address can not be configured, please check whether Spanning-tree, dot1x, TRUNK is running on the switch and whether the port is configured as a MAC-binding port. The number limitation function of MAC address is mutually exclusive to these configurations, so if the users need to enable the number limitation function of MAC address on the port, they should check these functions mentioned above on this port are disabled.

If all the configurations are normal, after enabling the number limitation function of port, MAC in VLAN and IP, users can use debug commands to debug every limitation, check the details of number limitations and judge whether the number limitation function is correct. If there is any problem, please sent result to technical service center.

Chapter 49 Operational Configuration of AM Function

49.1 Introduction to AM Function

AM (Access Management) means that when a switch receives an IP or ARP message, it will compare the information extracted from the message (such as source IP address or source MAC-IP address) with the configured hardware address pool. If there is an entry in the address pool matching the information (source IP address or source MAC-IP address), the message will be forwarded, otherwise, dumped. The reason why source-IP-based AM should be supplemented by source-MAC-IP-based AM is that IP address of a host might change. Only with a bound IP, can users change the IP of the host into forwarding IP, and hence enable the messages from the host to be forwarded by the switch. Given the fact that MAC-IP can be exclusively bound with a host, it is necessary to make MAC-IP bound with a host for the purpose of preventing users from maliciously modifying host IP to forward the messages from their hosts via the switch.

With the interface-bound attribute of AM, network managers can bind the IP (MAC-IP) address of a legal user to a specified interface. After that, only the messages sending by users with specified IP (MAC-IP) addresses can be forwarded via the interface, and thus strengthen the monitoring of the network security.

49.2 AM Function Configuration Task List

- 1 · Enable AM function
- 2 · Enable AM function on an interface
- 3 · Configure the forwarding IP
- 4 · Configure the forwarding MAC-IP
- 5 · Delete all of the configured IP or MAC-IP or both
- 6 · Display relative configuration information of AM

1. Enable AM function

Command	Explanation
Global Mode	
am enable no am enable	Globally enable or disable AM function.

2. Enable AM function on an interface

Command	Explanation
Port Mode	
am port no am port	Enable/disable AM function on the port. When the AM function is enabled on the port, no IP or ARP message will be forwarded by default.

3. Configure the forwarding IP

Command	Explanation
Port Mode	
am ip-pool <ip-address> <num> no am ip-pool <ip-address> <num>	Configure the forwarding IP of the port.

4. Configure the forwarding MAC-IP

Command	Explanation
Port Mode	
am mac-ip-pool <mac-address> <ip-address> no am mac-ip-pool <mac-address> <ip-address>	Configure the forwarding MAC-IP of the port.

5. Delete all of the configured IP or MAC-IP or both

Command	Explanation
Global Mode	
no am all [ip-pool mac-ip-pool]	Delete MAC-IP address pool or IP address pool or both pools configured by all users.

6. Display related configuration information of AM

Command	Explanation
Global Configuration Mode	
show am [interface <interface-name>]	Display the AM configuration information of one port or all ports.

49.3 AM Function Example

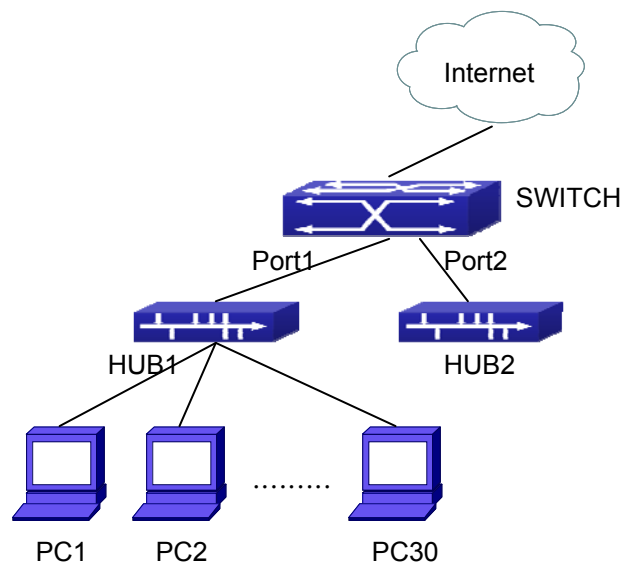

Figure 49-3-1 a typical configuration example of AM function

In the topology above, 30 PCs, after converged by HUB1, connect with interface1 on the switch. The IP addresses of these 30 PCs range from 100.10.10.1 to 100.10.10.30. Considering security, the system manager will only take user with an IP address within that range as legal ones. And the switch will only forward data packets from legal users while dumping packets from other users.

According to the requirements mentioned above, the switch can be configured as follows:

```
XGS3-42000R(config)#am enable
XGS3-42000R(config)#interface ethernet1/1
XGS3-42000R(config-if-Ethernet1/1)#am port
XGS3-42000R(config-if-Ethernet1/1)#am ip-pool 10.10.10.1 10
```

49.4 AM Function Troubleshooting

AM function is disabled by default, and after it is enabled, relative configuration of AM can be made. Users can view the current AM configuration with “show am” command, such as whether the AM is enabled or not, and AM information on each interface, they can also use “**show am [interface <interface-name>]**” command to check the AM configuration information on a specific interface.

If any operational error happens, the system will display detailed corresponding prompt.

Chapter 50 Security Feature Configuration

50.1 Introduction to Security Feature

Before introducing the security features, we here first introduce the DoS. The DoS is short for Denial of Service, which is a simple but effective destructive attack on the internet. The server under DoS attack will drop normal user data packet due to non-stop processing the attacker's data packet, leading to the denial of the service and worse can lead to leak of sensitive data of the server.

Security feature refers to applications such as protocol check which is for protecting the server from attacks such as DoS. The protocol check allows the user to drop matched packets based on specified conditions. The security features provide several simple and effective protections against Dos attacks while acting no influence on the linear forwarding performance of the switch.

50.2 Security Feature Configuration

50.2.1 Prevent IP Spoofing Function Configuration Task

Sequence

- 1 · Enable the IP spoofing function.

Command	Explanation
Global Mode	
[no] dosattack-check srcip-equal-dstip enable	Enable/disable the function of checking if the IP source address is the same as the destination address.

50.2.2 Prevent TCP Unauthorized Label Attack Function

Configuration Task Sequence

- 1 · Enable the anti TCP unauthorized label attack function
- 2 · Enable Checking IPv4 fragment function

Command	Explanation
Global Mode	
[no] dosattack-check tcp-flags enable	Enable/disable checking TCP label function

[no] dosattack-check ipv4-first-fragment enable	Enable/disable checking IPv4 fragment. This command has no effect when used separately, but if this function is not enabled, the switch will not drop the IPv4 fragment packet containing unauthorized TCP labels.
--	--

50.2.3 Anti Port Cheat Function Configuration Task Sequence

- 1 · Enable the anti port cheat function

Command	Explanation
Global Mode	
[no] dosattack-check srcport-equal-dstport enable	Enable/disable the prevent-port-cheat function.
dosattack-check ipv4-first-fragment enable	Enable/disable checking IPv4 fragment. This command has no effect when used separately, but if this function is not enabled, the switch will not drop the IPv4 fragment packet whose source port is equal to its destination port.

50.2.4 Preventing TCP Fragment Attack Function Configuration Task Sequence

- 1 · Enable the prevent TCP fragment attack function
- 2 · Configure the minimum permitted TCP head length of the packet

Command	Explanation
Global Mode	
[no] dosattack-check tcp-fragment enable	Enable/disable the prevent TCP fragment attack function.
dosattack-check tcp-header <size>	Configure the minimum permitted TCP head length of the packet. This command has no effect when used separately, the user should enable the dosattack-check tcp-fragment enable .

50.2.5 Preventing ICMP Fragment Attack Function Configuration Task Sequence

1. Enable the prevent ICMP fragment attack function
2. Configure the max permitted ICMPv4 net load length
3. Configure the max permitted ICMPv6 net load length

Command	Explanation
Global Mode	
[no] dosattack-check icmp-attacking enable	Enable/disable the prevent ICMP fragment attack function.
dosattack-check icmpv4-size <size>	Configure the max permitted ICMPv4 net load length. This command has not effect when used separately, the user have to enable the dosattack-check icmp-attacking enable .
dosattack-check icmpv6-size <size>	Configure the max permitted ICMPv6 net load length. This command has not effect when used separately, the user have to enable the dosattack-check icmp-attacking enable .

50.3 Security Feature Example

Scenario:

The User has follows configuration requirements: the switch do not forward data packet whose source IP address is equal to the destination address, and those whose source port is equal to the destination port. Only the ping command with defaulted options is allowed within the IPv4 network, namely the ICMP request packet can not be fragmented and its net length is normally smaller than 100.

Configuration procedure:

```
XGS3-42000R(config)# dosattack-check srcip-equal-dstip enable
XGS3-42000R(config)# dosattack-check srcport-equal-dstport enable
XGS3-42000R(config)# dosattack-check ipv4-first-fragment enable
XGS3-42000R(config)# dosattack-check icmp-attacking enable
XGS3-42000R(config)# dosattack-check icmpV4-size 100
```

Chapter 51 TACACS+ Configuration

51.1 Introduction to TACACS+

TACACS+ terminal access controller access control protocol is a protocol similar to the radius protocol for control the terminal access to the network. Three independent functions of Authentication, Authorization, Accounting are also available in this protocol. Compared with RADIUS, the transmission layer of TACACS+ protocol is adopted with TCP protocol, further with the packet head (except for standard packet head) encryption, this protocol is of a more reliable transmission and encryption characteristics, and is more adapted to security control.

According to the characteristics of the TACACS+ (Version 1.78), we provide TACACS+ authentication function on the switch, when the user logs, such as telnet, the authentication of user name and password can be carried out with TACACS+.

51.2 TACACS+ Configuration Task List

1. Configure the TACACS+ authentication key
2. Configure the TACACS+ server
3. Configure the TACACS+ authentication timeout time
4. Configure the IP address of the RADIUS NAS

1. Configure the TACACS+ authentication key

Command	Explanation
Global Mode	
tacacs-server key <string> no tacacs-server key	Configure the TACACS+ server key; the “no tacacs-server key” command deletes the key.

2. Configure TACACS+ server

Command	Explanation
Global Mode	
tacacs-server authentication host <IPaddress> [[port {<portNum>}] [timeout <seconds>] [key <string>] [primary]] no tacacs-server authentication host <IPaddress>	Configure the IP address, listening port number, the value of timeout timer and the key string of the TACACS+ server; the no form of this command deletes the TACACS+ authentication server.

3. Configure the TACACS+ authentication timeout time

Command	Explanation
Global Mode	
tacacs-server timeout <seconds> no tacacs-server timeout	Configure the authentication timeout for the TACACS+ server, the “no tacacs-server timeout” command restores the default configuration.

4. Configure the IP address of the TACACS+ NAS

Command	Explanation
Global Mode	
tacacs-server nas-ipv4 <ip-address> no tacacs-server nas-ipv4	To configure the source IP address for the TACACS+ packets for the switch.

51.3 TACACS+ Scenarios Typical Examples

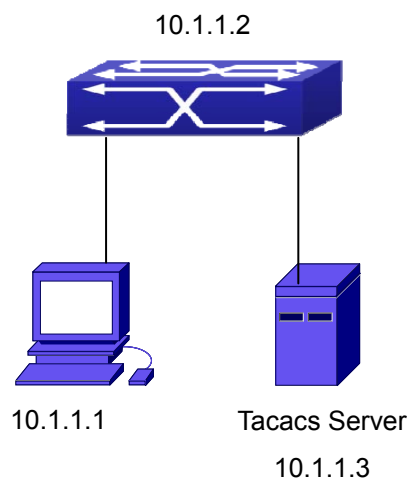

Figure 51-3-1 TACACS Configuration

A computer connects to a switch, of which the IP address is 10.1.1.2 and connected with a TACACS+ authentication server; IP address of the server is 10.1.1.3 and the authentication port is defaulted at 49, set telnet log on authentication of the switch as tacacs local, via using TACACS+ authentication server to achieve telnet user authentication.

```
XGS3-42000R(config)#interface vlan 1
XGS3-42000R(config-if-vlan1)#ip address 10.1.1.2 255.255.255.0
XGS3-42000R(config-if-vlan1)#exit
XGS3-42000R(config)#tacacs-server authentication host 10.1.1.3
XGS3-42000R(config)#tacacs-server key test
XGS3-42000R(config)#authentication login vty tacacs local
```

51.4 TACACS+ Troubleshooting

In configuring and using TACACS+, the TACACS+ may fail to authentication due to reasons such as physical connection failure or wrong configurations. The user should ensure the following:

- First good condition of the TACACS+ server physical connection.
- Second all interface and link protocols are in the UP state (use “**show interface**” command).
- Then ensure the TACACS+ key configured on the switch is in accordance with the one configured on TACACS+ server.
- Finally ensure to connect to the correct TACACS+ server.

Chapter 52 RADIUS Configuration

52.1 Introduction to RADIUS

52.1.1 AAA and RADIUS Introduction

AAA is short for Authentication, Authorization and Accounting, it provide a consistency framework for the network management safely. According to the three functions of Authentication, Authorization, Accounting, the framework can meet the access control for the security network: which one can visit the network device, which access-level the user can have and the accounting for the network resource.

RADIUS (Remote Authentication Dial in User Service), is a kind of distributed and client/server protocol for information exchange. The RADIUS client is usually used on network appliance to implement AAA in cooperation with 802.1x protocol. The RADIUS server maintains the database for AAA, and communicates with the RADIUS client through RADIUS protocol. The RADIUS protocol is the most common used protocol in the AAA framework.

52.1.2 Message structure for RADIUS

The RADIUS protocol uses UDP to deliver protocol packets. The packet format is shown as below.

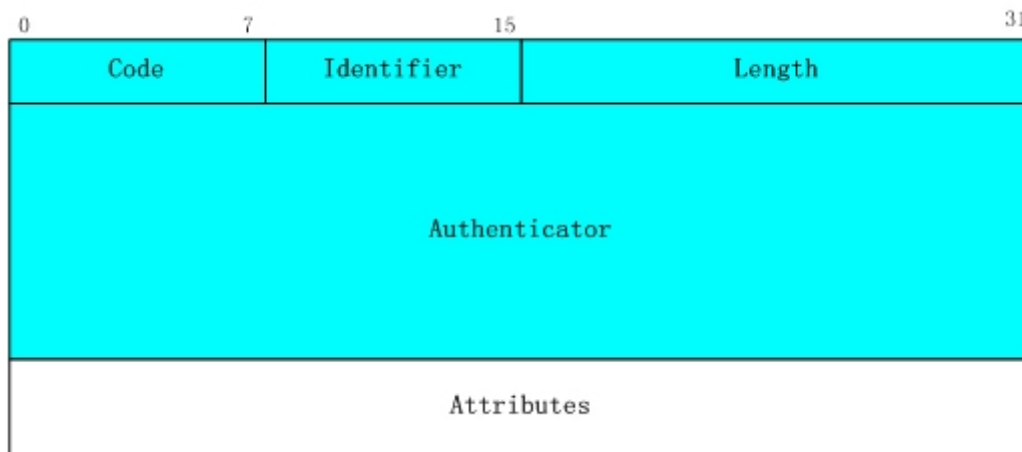

Figure 52-1-1 Message structure for RADIUS

Code field(1octets): is the type of the RADIUS packet. Available value for the Code field is show as below:

- 1 · Access-Request
- 2 · Access-Accept
- 3 · Access-Reject
- 4 · Accounting-Request
- 5 · Accounting-Response
- 6 · Access-Challenge

Identifier field (1 octet): Identifier for the request and answer packets.

Length field (2 octets): The length of the overall RADIUS packet, including Code, Identifier, Length, Authenticator and Attributes

Authenticator field (16 octets): used for validation of the packets received from the RADIUS server. Or it can be used to carry encrypted passwords. This field falls into two kinds: the Request Authenticator and the Response Authenticator.

Attribute field: used to carry detailed information about AAA. An Attribute value is formed by Type, Length, and Value fields.

- Type field (1 octet), the type of the attribute value, which is shown as below:

Property	Type of property	Property	Type of property
1	User-Name	23	Framed-IPX-Network
2	User-Password	24	State
3	CHAP-Password	25	Class
4	NAS-IP-Address	26	Vendor-Specific
5	NAS-Port	27	Session-Timeout
6	Service-Type	28	Idle-Timeout
7	Framed-Protocol	29	Termination-Action
8	Framed-IP-Address	30	Called-Station-Id
9	Framed-IP-Netmask	31	Calling-Station-Id
10	Framed-Routing	32	NAS-Identifier
11	Filter-Id	33	Proxy-State
12	Framed-MTU	34	Login-LAT-Service
13	Framed-Compression	35	Login-LAT-Node
14	Login-IP-Host	36	Login-LAT-Group
15	Login-Service	37	Framed-AppleTalk-Link
16	Login-TCP-Port	38	Framed-AppleTalk-Network
17	(unassigned)	39	Framed-AppleTalk-Zone
18	Reply-Message	40-59	(reserved for accounting)
19	Callback-Number	60	CHAP-Challenge
20	Callback-Id	61	NAS-Port-Type
21	(unassigned)	62	Port-Limit
22	Framed-Route	63	Login-LAT-Port

- Length field (1 octet), the length in octets of the attribute including Type, Length and Value fields.
- Value field, value of the attribute whose content and format is determined by the type and length of the attribute.

52.2 RADIUS Configuration Task List

- 1 · Enable the authentication and accounting function.
- 2 · Configure the RADIUS authentication key.
- 3 · Configure the RADIUS server.
- 4 · Configure the parameter of the RADIUS service.
- 5 · Configure the IP address of the RADIUS NAS.

1. Enable the authentication and accounting function.

Command	Explanation
Global Mode	
aaa enable no aaa enable	To enable the AAA authentication function. The no form of this command will disable the AAA authentication function.
aaa-accounting enable no aaa-accounting enable	To enable AAA accounting. The no form of this command will disable AAA accounting.
aaa-accounting update {enable/disable}	Enable or disable the update accounting function.

2. Configure the RADIUS authentication key.

Command	Explanation
Global Mode	
radius-server key <string> no radius-server key	To configure the encryption key for the RADIUS server. The no form of this command will remove the configured key.

3. Configure the RADIUS server.

Command	Explanation
Global Mode	
radius-server authentication host { <IPaddress> <IPv6address> } [[port {<portNum>}] [key <string>] [primary] [access-mode {dot1x telnet}] no radius-server authentication host <IPaddress>	Specifies the IP address and listening port number, cipher key, whether be primary server or not and access mode for the RADIUS server; the no command deletes the RADIUS authentication server.
radius-server accounting host { <IPaddress> <IPv6address> } [[port {<portNum>}] [primary]] no radius-server accounting host <IPaddress>	To configure the IP/IPv6 address and the port number for the accounting RADIUS server. The no form of this command will remove the RADIUS server configuration.

4. Configure the parameter of the RADIUS service

Command	Explanation
Global Mode	
radius-server dead-time <minutes> no radius-server dead-time	To configure the interval that the RADIUS becomes available after it is down. The no form of this command will restore the default configuration.
radius-server retransmit <retries> no radius-server retransmit	To configure retry times for the RADIUS packets. The no form of this command restores the default configuration.
radius-server timeout <seconds> no radius-server timeout	To configure the timeout value for the RADIUS server. The no form of this command will restore the default configuration.
radius-server accounting-interim-update timeout <seconds> no radius-server accounting-interim-update timeout	To configure the update interval for accounting. The no form of this command will restore the default configuration.

5. Configure the IP address of the RADIUS NAS

Command	Explanation
Global Mode	
radius nas-ipv4 <ip-address> no radius nas-ipv4	To configure the source IP address for the RADIUS packets for the switch.
radius nas-ipv6 <ipv6-address> no radius nas-ipv6	To configure the source IPv6 address for the RADIUS packets for the switch.

52.3 RADIUS Typical Examples

52.3.1 IPv4 Radius Example

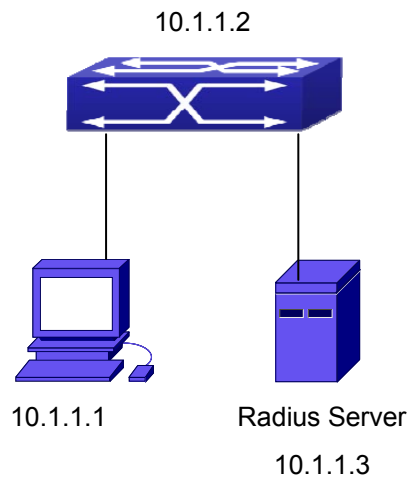

Figure 52-3-1 The Topology of IEEE802.1x configuration

A computer connects to a switch, of which the IP address is 10.1.1.2 and connected with a RADIUS authentication server without Ethernet1/2; IP address of the server is 10.1.1.3 and the authentication port is defaulted at 1812, accounting port is defaulted at 1813.

Configure steps as below:

```
XGS3-42000R(config)#interface vlan 1
XGS3-42000R(config-if-vlan1)#ip address 10.1.1.2 255.255.255.0
XGS3-42000R(config-if-vlan1)#exit
XGS3-42000R(config)#radius-server authentication host 10.1.1.3
XGS3-42000R(config)#radius-server accounting host 10.1.1.3
XGS3-42000R(config)#radius-server key test
XGS3-42000R(config)#aaa enable
XGS3-42000R(config)#aaa-accounting enable
```

52.3.2 IPv6 RadiusExample

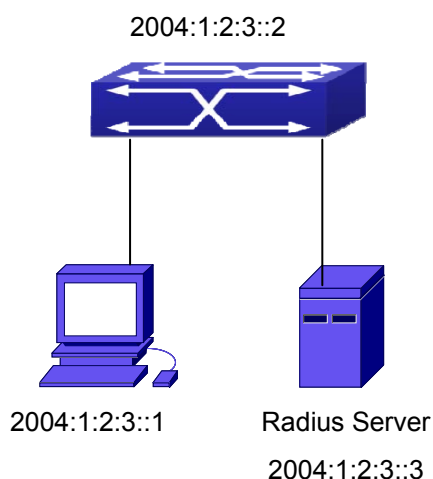

Figure 52-3-2 The Topology of IPv6 Radius configuration

A computer connects to a switch, of which the IP address is 2004:1:2:3::2 and connected with a RADIUS authentication server without Ethernet1/2; IP address of the server is 2004:1:2:3::3 and the authentication port is defaulted at 1812, accounting port is defaulted at 1813.

Configure steps as below:

```
XGS3-42000R(config)#interface vlan 1
XGS3-42000R(config-if-vlan1)#ipv6 address 2004:1:2:3::2/64
XGS3-42000R(config-if-vlan1)#exit
XGS3-42000R(config)#radius-server authentication host 2004:1:2:3::3
XGS3-42000R(config)#radius-server accounting host 2004:1:2:3::3
XGS3-42000R(config)#radius-server key test
XGS3-42000R(config)#aaa enable
XGS3-42000R(config)#aaa-accounting enable
```

52.4 RADIUS Troubleshooting

In configuring and using RADIUS, the RADIUS may fail to authentication due to reasons such as physical connection failure or wrong configurations. The user should ensure the following:

- First make sure good condition of the RADIUS server physical connection;
- Second all interface and link protocols are in the UP state (use “**show interface**” command)
- Then ensure the RADIUS key configured on the switch is in accordance with the one configured on RADIUS server;
- Finally ensure to connect to the correct RADIUS server

If the RADIUS authentication problem remains unsolved, please use **debug aaa** and other debugging command and copy the DEBUG message within 3 minutes, send the recorded message to the technical server center of our company.

Chapter 53 SSL Configuration

53.1 Introduction to SSL

As the computer networking technology spreads, the security of the network has been taking more and more important impact on the availability and the usability of the networking application. The network security has become one of the greatest barriers of modern networking applications.

To protect sensitive data transferred through Web, Netscape introduced the Secure Socket Layer – SSL protocol, for its Web browser. Up till now, SSL 2.0 and 3.0 has been released. SSL 2.0 is obsolete because of security problems, and it is not supported on the switches of Network. The SSL protocol uses the public-key encryption, and has become the industry standard for secure communication on internet for Web browsing. The Web browser integrates HTTP and SSL to realize secure communication.

SSL is a safety protocol to protect private data transmission on the Internet. SSL protocols are designed for secure transmission between the client and the server, and authentication both at the server sides and optional client. SSL protocols must build on reliable transport layer (such as TCP). SSL protocols are independent for application layer. Some protocols such as HTTP, FTP, TELNET and so on, can build on SSL protocols transparently. The SSL protocol negotiates for the encryption algorithm, the encryption key and the server authentication before data is transmitted. Ever since the negotiation is done, all the data being transferred will be encrypted.

Via above introduction, the security channel is provided by SSL protocols have below three characteristics:

- Privacy. First they encrypt the suite through negotiation, then all the messages be encrypted.
- Affirmation. Though the client authentication of the conversational is optional, but the server is always authenticated.
- Reliability. The message integrity inspect is included in the sending message (use MAC).

53.1.1 Basic Element of SSL

The basic strategy of SSL provides a safety channel for random application data forwarding between two communication programs. In theory, SSL connect is similar with encrypt TCP connect. The position of SSL protocol is under application layer and on the TCP. If the mechanism of the data forwarding in the lower layer is reliable, the data read-in the network will be forwarded to the other program in sequence, lose packet and re-forwarding will not appear. A lot of transmission protocols can provide such kind of service in theory, but in actual application, SSL is almost running on TCP, and not running on UDP and IP directly.

When web function is running on the switch and client visit our web site through the internet browser, we can use SSL function. The communication between client and switch through SSL connect can improve the security.

Firstly, SSL should be enabled on the switch. When the client tries to access the switch through https method, a SSL session will be set up between the switch and the client. When the SSL session has been set up, all the data transmission in the application layer will be encrypted.

SSL handshake is done when the SSL session is being set up. The switch should be able to provide certification keys. Currently the keys provided by the switch are not the formal certification keys issued by official authentic, but the private certification keys generated by SSL software under Linux which may not be recognized by the web browser. With regard to the switch application, it is not necessary to apply for a formal SSL certification key. A private certification key is enough to make the communication safe between the users and the switch. Currently it is not required that the client is able to check the validation of the certification key. The encryption key and the encryption method should be negotiated during the handshake period of the session which will be then used for data encryption.

SSL session handshake process:

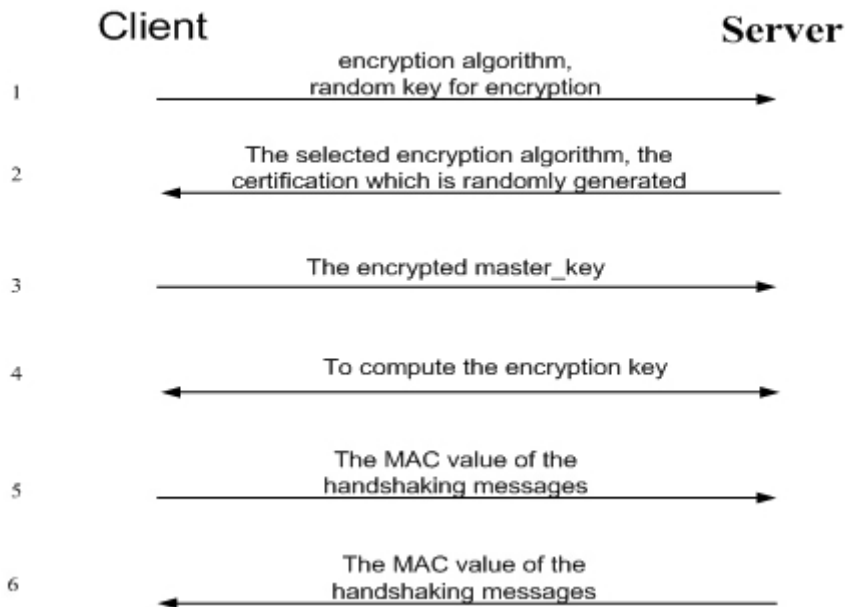

53.2 SSL Configuration Task List

1. Enable/disable SSL function
2. Configure/delete port number by SSL used
3. Configure/delete secure cipher suite by SSL used
4. Maintenance and diagnose for the SSL function

1. Enable/disable SSL function

Command	Explanation
Global Mode	
ip http secure-server no ip http secure-server	Enable/disable SSL function.

2. Configure/delete port number by SSL used

Command	Explanation
Global Mode	
ip http secure-port <port-number> no ip http secure-port	Configure port number by SSL used, the “ no ip http secure-port ” command deletes the port number.

3. Configure/delete secure cipher suite by SSL used

Command	Explanation
Global Mode	
ip http secure-ciphersuite {des-cbc3-sha rc4-128-sha des-cbc-sha} no ip http secure-ciphersuite	Configure/delete secure cipher suite by SSL used.

4. Maintenance and diagnose for the SSL function

Command	Explanation
Admin Mode or Configuration Mode	
show ip http secure-server status	Show the configured SSL information.
debug ssl no debug ssl	Open/close the DEBUG for SSL function.

53.3 SSL Typical Example

When the Web function is enabled on the switch, SSL can be configured for users to access the web interface on the switch. If the SSL has been configured, communication between the client and the switch will be encrypted through SSL for safety.

Firstly, SSL should be enabled on the switch. When the client tries to access the switch through https method, a SSL session will be set up between the switch and the client. When the SSL session has been set up, all the data transmission in the application layer will be encrypted.

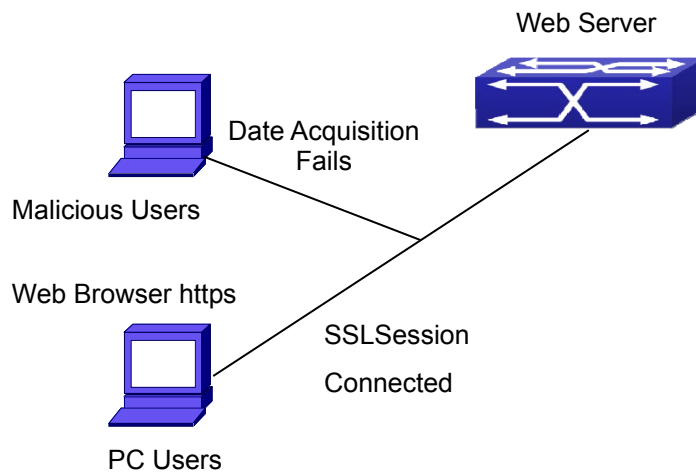

Configuration on the switch:

```
XGS3-42000R(config)# ip http secure-server
XGS3-42000R(config)# ip http secure-port 1025
XGS3-42000R(config)# ip http secure-ciphersuite rc4-128-sha
```

53.4 SSL Troubleshooting

In configuring and using SSL, the SSL function may fail due to reasons such as physical connection failure or wrong configurations. The user should ensure the following:

- First good condition of the physical connection;
- Second all interface and link protocols are in the UP state (use “show interface” command);
- Then, make sure SSL function is enabled (use ip http secure-server command);
- Don't use the default port number if configured port number, pay attention to the port number when input the web wide;
- If SSL is enabled, SSL should be restarted after changes on the port configuration and encryption configuration;
- IE 7.0 or above should be used for use of des-cbc-sha;
- If the SSL problems remain unsolved after above try, please use debug SSL and other debugging command and copy the DEBUG message within 3 minutes, send the recorded message to technical server center of our company.

Chapter 54 IPv6 Security RA Configuration

54.1 Introduction to IPv6 Security RA

In IPv6 networks, the network topology is generally compromised of routers, layer-two switches and IPv6 hosts. Routers usually advertise RA, including link prefix, link MTU and other information, when the IPv6 hosts receive RA, they will create link address, and set the default router as the one sending RA in order to implement IPv6 network communication. If a vicious IPv6 host sends RA to cause that normal IPv6 users set the default router as the vicious IPv6 host user, the vicious user will be able to capture the information of other users, which will threat the network security. Simultaneously, the normal users get incorrect address and will not be able to connect to the network. So, in order to implement the security RA function, configuring on the switch ports to reject vicious RA messages is necessary, thus to prevent forwarding vicious RA to a certain extent and to avoid affecting the normal operation of the network.

54.2 IPv6 Security RA Configuration Task Sequence

1. Globally enable IPv6 security RA
2. Enable IPv6 security RA on a port
3. Display and debug the relative information of IPv6 security RA

1. Globally enable IPv6 security RA

Command	Explanation
Global Configuration Mode	
ipv6 security-ra enable no ipv6 security-ra enable	Globally enable and disable IPv6 security RA.

2. Enable IPv6 security RA on a port

Command	Explanation
Port Configuration Mode	
ipv6 security-ra enable no ipv6 security-ra enable	Enable and disable IPv6 security RA in port configuration mode.

3. Display and debug the relative information of IPv6 security RA

Command	Explanation
Admin Mode	
debug ipv6 security-ra no debug ipv6 security-ra	Enable the debug information of IPv6 security RA module, the no operation of this command will disable the output of debug information of IPv6 security RA.

<code>show ipv6 security-ra [interface <interface-list>]</code>	Display the distrust port and whether globally security RA is enabled.
---	--

54.3 IPv6 Security RA Typical Examples

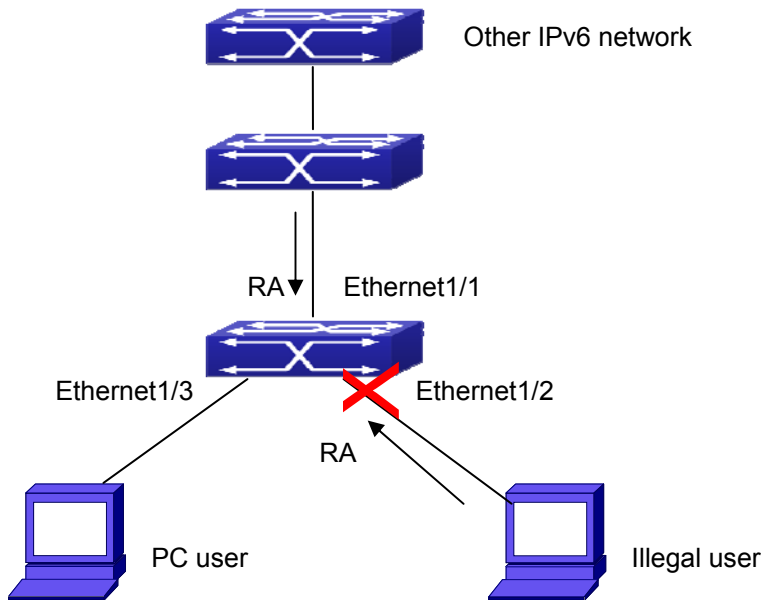

Instructions: if the illegal user in the graph advertises RA, the normal user will receive the RA, set the default router as the vicious IPv6 host user and change its own address. This will cause the normal user to not be able to connect the network. We want to set security RA on the 1/2 port of the switch, so that the RA from the illegal user will not affect the normal user.

Switch configuration task sequence:

```
XGS3-42000R#config
XGS3-42000R(config)#ipv6 security-ra enable
XGS3-42000R(config-if-Ethernet1/2)# ipv6 security-ra enable
```

54.4 IPv6 Security RA Troubleshooting Help

The function of IPv6 security RA is quite simple, if the function does not meet the expectation after configuring IPv6 security RA:

- Check if the switch is correctly configured.
- Check if there are rules conflicting with security RA function configured on the switch, this kind of rules will cause RA messages to be forwarded..

Chapter 55 VLAN-ACL Configuration

55.1 Introduction to VLAN-ACL

The user can configure ACL policy to VLAN to implement the accessing control of all ports in VLAN, and VLAN-ACL enables the user to expediently manage the network. The user only needs to configure ACL policy in VLAN, the corresponding ACL action can takes effect on all member ports of VLAN, but it does not need to solely configure on each member port.

When VLAN ACL and Port ACL are configured at the same time, the principle of denying firstly is used. When the packets match VLAN ACL and Port ACL at the same time, as long as one rule is drop, then the final action is drop.

Egress ACL can implement the filtering of the packets on egress and ingress direction, the packets match the specific rules can be allowed or denied. ACL can support IP ACL, MAC ACL, MAC-IP ACL, IPv6 ACL. Ingress direction of VLAN can bind four kinds of ACL at the same time, there are four resources on egress direction of VLAN, IP ACL and MAC ACL engage one resource severally, MAC-IP ACL and IPv6 ACL engage two resources severally, so egress direction of VLAN can not bind four kinds of ACL at the same time. When binding three kinds of ACL at the same time, it should be the types of IP, MAC, MAC-IP or IP, MAC, IPv6. When binding two kinds of ACL at the same time, any combination of ACL type is valid. Each type can only apply one on a VLAN.

55.2 VLAN-ACL Configuration Task List

1. Configure VLAN-ACL of IP type
2. Configure VLAN-ACL of MAC type
3. Configure VLAN-ACL of MAC-IP
4. Configure VLAN-ACL of IPv6 type
5. Show configuration and statistic information of VLAN-ACL
6. Clear statistic information of VLAN-ACL

1. Configure VLAN-ACL of IP type

Command	Explanation
Global mode	
vacl ip access-group {<1-299> WORD} {in out} [traffic-statistic] vlan WORD no vacl ip access-group {<1-299> WORD} {in out} vlan WORD	Configure or delete IP VLAN-ACL.

2. Configure VLAN-ACL of MAC type

Command	Explanation
Global mode	
vacl mac access-group {<700-1199> WORD } {in out} [traffic-statistic] vlan WORD no vacl mac access-group {<700-1199> WORD } {in out} vlan WORD	Configure or delete MAC VLAN-ACL.

3. Configure VLAN-ACL of MAC-IP

Command	Explanation
Global mode	
vacl mac-ip access-group {<3100-3299> WORD } {in out} [traffic-statistic] vlan WORD no vacl mac-ip access-group {<3100-3299> WORD } {in out} vlan WORD	Configure or delete MAC-IP VLAN-ACL.

4. Configure VLAN-ACL of IPv6 type

Command	Explanation
Global mode	
vacl ipv6 access-group (<500-699> WORD) {in out} (traffic-statistic) vlan WORD no ipv6 access-group {<500-699> WORD } {in out} vlan WORD	Configure or delete IPv6 VLAN-ACL.

5. Show configuration and statistic information of VLAN-ACL

Command	Explanation
Admin mode	
show vacl [in out] vlan [<vlan-id>]	Show the configuration and the statistic information of VACL.

6. Clear statistic information of VLAN-ACL

Command	Explanation
Admin mode	
clear vacl [in out] statistic vlan [<vlan-id>]	Clear the statistic information of VACL.

55.3 VLAN-ACL Configuration Example

A company's network configuration is as follows, all departments are divided by different VLANs, technique department is Vlan1, finance department is Vlan2. It is required that technique department can access the outside network at timeout, but finance department are not allowed to access the outside network at any time for the security. Then the following policies are configured:

- Set the policy VACL_A for technique department. At timeout they can access the outside network, the rule as permit, but other times the rule as deny, and the policy is applied to Vlan1.
- Set the policy VACL_B of ACL for finance department. At any time they can not access the outside network, but can access the inside network with no limitation, and apply the policy to Vlan2.

Network environment is shown as below:

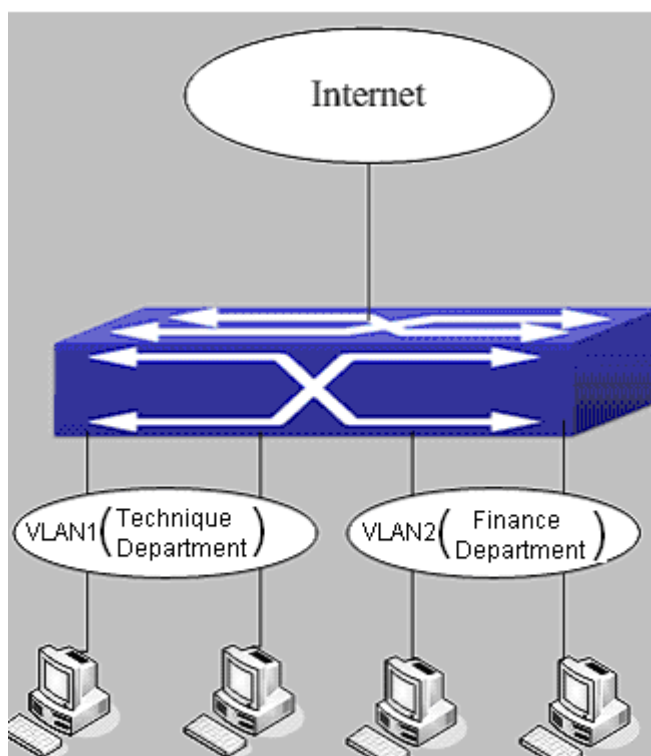

Figure 55-3-1 VLAN-ACL configuration example

Configuration example:

- 1) First, configure a time range, the valid time is the working hours of working day:

```
XGS3-42000R(config)#time-range t1
XGS3-42000R(config-time-range-t1)#periodic weekdays 9:00:00 to 12:00:00
XGS3-42000R(config-time-range-t1)#periodic weekdays 13:00:00 to 18:00:00
```

- 2) Configure the extended acl_a of IP, at working hours it only allows to access the resource within the internal network (such as 192.168.0.255).

```
XGS3-42000R(config)# ip access-list extended vacl_a
XGS3-42000R(config-ip-ext-nacl-vacl_a)# permit ip any-source 192.168.0.0 0.0.0.255 time-range t1
XGS3-42000R(config-ip-ext-nacl-vacl_a)# deny ip any-source any-destination time-range t1
```

3) Configure the extended acl_b of IP, at any time it only allows to access resource within the internal network (such as 192.168.1.255).

```
XGS3-42000R(config)#ip access-list extended vacl_b
XGS3-42000R(config-ip-ext-nacl-vacl_a)# permit ip any-source 192.168.1.0 0.0.0.255
XGS3-42000R(config-ip-ext-nacl-vacl_a)# deny ip any-source any-destination
```

4) Apply the configuration to VLAN

```
XGS3-42000R(config)#vacl ip access-group vacl_a in vlan 1
XGS3-42000R(config)#vacl ip access-group vacl_b in vlan 2
```

55.4 VLAN-ACL Troubleshooting

- When VLAN ACL and Port ACL are configured at the same time, the principle of denying firstly is used. When the packets match VLAN ACL and Port ACL at the same time, as long as one rule is drop, then the final action is drop.
- Each ACL of different types can only apply one on a VLAN, such as the basic IP ACL, each VLAN can applies one only.

55.5 Introduction to Mirror

Mirror functions include port mirror function, CPU mirror function, flow mirror function.

Port mirror refers to the duplication of data frames sent/received on a port to another port. The duplicated port is referred to as mirror source port and the duplicating port is referred to as mirror destination port. A protocol analyzer (such as Sniffer) or a RMON monitor will be connected at mirror destination port to monitor and manage the network, and diagnose the problems in the network.

CPU mirror function means that the switch exactly copies the data frames received or sent by the CPU to a port. Flow mirror function means that the switch exactly copies the data frames received or by the specified rule of a port to another port. The flow mirror will take effect only the specified rule is permit.

A Chassis Switch supports at most 4 mirror destination ports, each boardcard allows a source or destination port of a mirror session. At present, each box switch can set many mirror sessions. For 5950 series box switches, many mirror sessions are not supported by XGS3-24040-52T/XGS3-24040-52T-L. There is no limitation on mirror source ports, one port or several ports is allowed. When there are more than one source ports, they can be in the same VLAN or in different VLAN. The source port and destination port can be in different VLAN.



box switch can't use CPU's rx mirror and port's tx mirror at the same time.

55.6 Mirror Configuration Task List

1. Specify mirror destination port
2. Specify mirror source port (CPU)
3. Specify flow mirror source

1. Specify mirror destination port

Command	Explanation
Global mode	
monitor session <session> destination interface <interface-number> no monitor session <session> destination interface <interface-number>	Specifies mirror destination port; the no command deletes mirror destination source port.

2. Specify mirror source port (CPU)

Command	Explanation
Global mode	
monitor session <session> source {interface <interface-list> / cpu [slot <slotnum>]} {rx tx both} no monitor session <session> source {interface <interface-list> / cpu [slot <slotnum>]}	Specifies mirror source port; the no command deletes mirror source port.

3. Specify flow mirror source

Command	Explanation
Global mode	
monitor session <session> source {interface <interface-list>} access-group <num> {rx tx both} no monitor session <session> source {interface <interface-list>} access-group <num>	Specifies flow mirror source port and apply rule; the no command deletes flow mirror source port.

55.7 Mirror Examples

Example:

The requirement of the configurations is shown as below: to monitor at interface 1 the data frames sent out by interface 9 and received from interface 7, sent and received by CPU, and the data frames received by interface 15 and matched by rule 120(The source IP address is 1.2.3.4 and the destination IP address is 5.6.7.8).

Configuration guidelines:

1. Configure interface 1 to be a mirror destination interface.
2. Configure the interface 7 ingress and interface 9 egress to be mirrored source.
3. Configure the CPU as one of the source.
4. Configure access list 120.
5. Configure access 120 to binding interface 15 ingress.

Configuration procedure is as follows:

```
XGS3-42000R(config)#monitor session 4 destination interface ethernet 1/1
XGS3-42000R(config)#monitor session 4 source interface ethernet 1/7 rx
XGS3-42000R(config)#monitor session 4 source interface ethernet 1/9 tx
XGS3-42000R(config)#monitor session 4 source cpu
XGS3-42000R(config)#access-list 120 permit tcp 1.2.3.4 0.0.0.255 5.6.7.8 0.0.0.255
XGS3-42000R(config)#monitor session 4 source interface ethernet 1/15 access-list 120 rx
```

55.8 Device Mirror Troubleshooting

If problems occur on configuring port mirroring, please check the following first for causes:

- Whether the mirror destination port is a member of a TRUNK group or not, if yes, modify the TRUNK group.
- If the throughput of mirror destination port is smaller than the total throughput of mirror source port(s), the destination port will not be able to duplicate all source port traffic; please decrease the number of source ports, duplicate traffic for one direction only or choose a port with greater throughput as the destination port. Mirror destination port can not be pulled into Isolate vlan, or will affect mirror between VLAN.

Chapter 56 RSPAN Configuration

56.1 Introduction to RSPAN

Port mirroring refers to the duplication of data frames sent/received on a port to another port. The duplicated port is referred to as mirror source port and the duplicating port is referred to as mirror destination port. It is more convenient for network administrator to monitor and manage the network and diagnostic after the mirroring function achieved. But it only used for such instance that the mirror source port and the mirror destination ports are located in the same switch.

RSPAN (remote switched port analyzer) refers to remote port mirroring. It eliminates the limitation that the source port and the destination port must be located on the same switch. This feature makes it possible for the source port and the destination port to be located on different devices in the network, and facilitates the network administrator to manage remote switches. It can't forward traffic flows on remote mirror VLAN.

There are three types of switches with the RSPAN enabled:

1. Source switch: The switch to which the monitored port belongs. The source switch copies the mirrored traffic flows to the Remote VLAN, and then through Layer 2 forwarding, the mirrored flows are sent to an intermediate switch or destination switch.
2. Intermediate switch: Switches between the source switch and destination switch on the network. Intermediate switch forwards mirrored flows to the next intermediate switch or the destination switch. Circumstances can occur where no intermediate switch is present, if a direct connection exists between the source and destination switches.
3. Destination switch: The switch to which the destination port for remote mirroring belongs. It forwards mirrored flows it received from the Remote VLAN to the monitoring device through the destination port.

When configuring the RSPAN mirroring of the source switch, reflector port mode or destination mirror port mode can be selected. The destination switch will redirect all the data frames in the RSPAN VLAN to the RSPAN destination port. For RSPAN mirroring, normal mode and advanced mode can be chosen, normal is introduced by default and fit the normal user. The advanced mode fit the advanced user.

1. Advanced mode: To redirect data frames in RSPAN VLAN to the RSPAN destination port, the intermediary and destination devices should support the redirection of flow.
2. Normal mode: To configure the RSPAN destination port in the RSPAN VLAN. Thus, datagrams in the RSPAN VLAN will be broadcasted to the destination port. In this mode, the destination port should be in RSPAN VLAN, and the source port should not be configured for broadcasting storm control. TRUNK ports should be configured carefully in order not to forward RSPAN datagrams to external networks. The normal mode has the benefit of easy configuration, and reduced system resources.

To be noticed: Normal mode is introduced by default. When using the normal mode, datagrams with reserved MAC addresses cannot be broadcasted.

For Chassis Switches, at most 4 mirror destination ports are supported, and source or destination port of one mirror session can be configured on each line card. For box switches, only one mirror session can be configured. The number of the source mirror ports is not limited, and can be one or more. Multiple source ports are not restricted to be in the same VLAN. The destination port and the source ports can be in different VLAN.

For configuration of RSPAN, a dedicated RSPAN VLAN should be configured first for carrying the RSPAN datagrams. The default VLAN, dynamic VLAN, private VLAN, multicast VLAN, and the layer 3 interface enabled VLAN cannot be configured as the RSPAN VLAN. The reflector port must belong to the RSPAN VLAN. The destination port should be connected to the Monitor and the configured as access port or the TRUNK port. The RSPAN reflector port will be working dedicatedly for mirroring, when a port is configured as a reflector port, it will discards all the existing connections to the remote peer, disable configurations related to loopback interfaces, and stop forwarding datagram. Connectivity between the source and destination switch for Remote VLAN, should be made sure by configuration.

To be noticed:

1. Layer 3 interfaces related to RSPAN VLAN should not be configured on the source, intermediate, and the destination switches, or the mirrored datagrams may be discarded.
2. For the source and intermediate switches in the RSPAN connections, the native VLAN of TRUNK port cannot be configured as the RSPAN VLAN, Otherwise the RSPAN tag will be disposed before reaching the destination switches.
3. The source port, in access or trunk mode, should not be added to RSPAN VLAN if advanced RSPAN mode is chosen. When the reflector port is used for a inter-card mirroring of CPU TX data, it must be configured as TRUNK port and allows the RSPAN VLAN data passing, the Native VLAN should not be configured as RSPAN VLAN.
4. When configuring the remote mirroring function, the network bandwidth should be considered in order to carry the network flow and the mirrored flow.

Keywords:

RSPAN: Remote Switched Port Analyzer

RSPAN VLAN: Dedicated VLAN for RSPAN

RSPAN Tag: The VLAN tag which is attached to MTP of the RSPAN datagrams.

Reflector Port: The local mirroring port between the RSPAN source and destination ports, which is not directly connected to the intermediate switches.

56.2 RSPAN Configuration Task List

1. Configure RSPAN VLAN
2. Configure mirror source port(CPU)
3. Configure mirror destination port
4. Configure reflector port
5. Configure remote VLAN of mirror group

1. Configure RSPAN VLAN

Command	Explanation
VLAN Configuration Mode	
remote-span no remote-span	To configure the specified VLAN as RSPAN VLAN. The no command will remove the configuration of RSPAN VLAN.

2. Configure mirror source port (CPU)

Command	Explanation
Global Mode	
monitor session <session> source {interface <interface-list> / cpu [slot <slotnum>]} {rx tx both} no monitor session <session> source {interface <interface-list> / cpu [slot <slotnum>]}	To configure mirror source port; The no command deletes the mirror source port.

3. Configure mirror destination port

Command	Explanation
Global Mode	
monitor session <session> destination interface <interface-number> no monitor session <session> destination interface <interface-number>	To configure mirror destination interface; The no command deletes the mirror destination port.

4. Configure reflector port

Command	Explanation
Global Mode	
monitor session <session> reflector-port <interface-number> no monitor session <session> reflector-port	To configure the interface to reflector port; The no command deletes the reflector port.

5. Configure remote VLAN of mirror group

Command	Explanation
Global Mode	
monitor session <session> remote vlan <vid> no monitor session <.session> remote vlan	To configure remote VLAN of mirror group, the no command deletes the remote VLAN of mirror group.

56.3 Typical Examples of RSPAN

Before RSPAN is invented, network administrators had to connect their PCs directly to the switches, in order to check the statistics of the network.

However, with the help of RSPAN, the network administrators can configure and supervise the switches remotely, which brings more efficiency. The figure below shows a sample application of RSPAN.

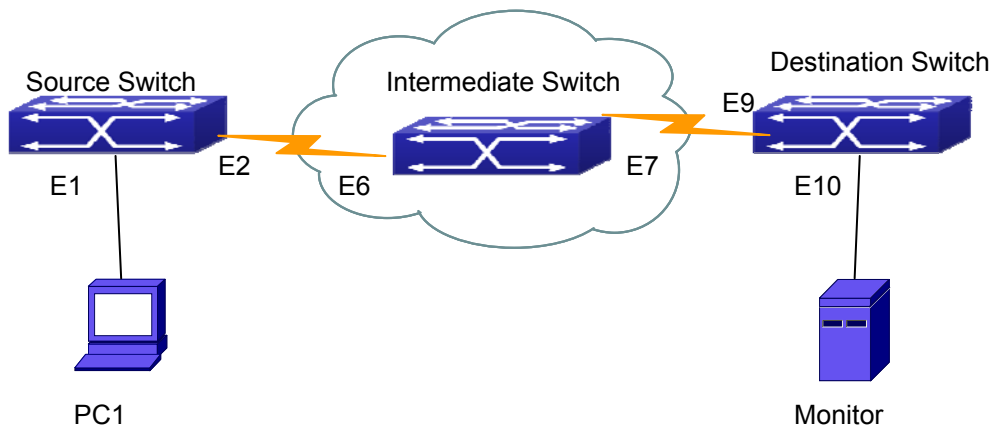

Figure 56-3-1 RSPAN Application Sample

Two configuration solutions can be chosen for RSPAN: the first is without reflector port, and the other is with reflector port. For the first one, only one fixed port can be connected to the intermediate switch. However, no reflector port has to be configured. This maximizes the usage of switch ports. For the latter one, the port connected to the intermediate switch is not fixed. Datagrams can be broadcasted in the RSPAN VLAN through the loopback, which is much more flexible.

The normal mode configuration is shown as below:

Solution 1:

Source switch:

Interface ethernet 1/1 is the source port for mirroring.

Interface ethernet 1/2 is the destination port which is connected to the intermediate switch.

RSPAN VLAN is 5.

```
XGS3-42000R(config)#vlan 5
XGS3-42000R(config-Vlan5)#remote-span
XGS3-42000R(config-Vlan5)#exit
XGS3-42000R(config)#interface ethernet 1/2
XGS3-42000R(config-If-Ethernet1/2)#switchport mode trunk
XGS3-42000R(config-If-Ethernet1/2)#exit
XGS3-42000R(config)#monitor session 1 source interface ethernet1/1 rx
XGS3-42000R(config)#monitor session 1 destination interface ethernet1/2
XGS3-42000R(config)#monitor session 1 remote vlan 5
```

Intermediate switch:

Interface ethernet1/6 is the source port which is connected to the source switch.

Interface ethernet1/7 is the destination port which is connected to the intermediate switch. The native VLAN of this port cannot be configured as RSPAN VLAN, or the mirrored data may not be carried by the destination switch.

RSPAN VLAN is 5.

```
XGS3-42000R(config)#vlan 5
XGS3-42000R(config-Vlan5)#remote-span
XGS3-42000R(config-Vlan5)#exit
XGS3-42000R(config)#interface ethernet 1/6-7
XGS3-42000R(config-If-Port-Range)#switchport mode trunk
XGS3-42000R(config-If-Port-Range)#exit
```

Destination switch:

Interface ethernet1/9 is the source port, which is connected to the source switch.

Interface ethernet1/10 is the destination port which is connected to the monitor. This port is required to be configured as an access port, and belong to the RSPAN VLAN.

RSPAN VLAN is 5.

```
XGS3-42000R(config)#vlan 5
XGS3-42000R(config-Vlan5)#remote-span
XGS3-42000R(config-Vlan5)#exit
XGS3-42000R(config)#interface ethernet 1/9
XGS3-42000R(config-If-Ethernet1/9)#switchport mode trunk
XGS3-42000R(config-If-Ethernet1/9)#exit
XGS3-42000R(config)#interface ethernet 1/10
XGS3-42000R(config-If-Ethernet1/10)#switchport access vlan 5
XGS3-42000R(config-If-Ethernet1/10)#exit
```

Solution 2:

Source switch:

Interface ethernet 1/1 is the source port.

Interface ethernet 1/2 is the TRUNK port, which is connected to the intermediate switch. The native VLAN should not be a RSPAN VLAN.

Interface Ethernet 1/3 is a reflector port. The reflector port belongs to the RSPAN VLAN, it is access port or TRUNK port of the RSPAN VLAN.

RSPAN VLAN is 5.

```
XGS3-42000R(config)#vlan 5
XGS3-42000R(config-Vlan5)#remote-span
XGS3-42000R(config-Vlan5)#exit
XGS3-42000R(config)#interface ethernet 1/2
XGS3-42000R(config-If-Ethernet1/2)#switchport mode trunk
XGS3-42000R(config-If-Ethernet1/2)#exit
XGS3-42000R(config)#interface ethernet 1/3
```

```
XGS3-42000R(config-If-Ethernet1/3)#switchport mode trunk
XGS3-42000R(config-If-Ethernet1/3)#exit
XGS3-42000R(config)#monitor session 1 source interface ethernet1/1 rx
XGS3-42000R(config)#monitor session 1 reflector-port ethernet1/3
XGS3-42000R(config)#monitor session 1 remote vlan 5
```

Intermediate switch:

Interface ethernet1/6 is the source port which is connected to the source switch.

Interface ethernet1/7 is the destination port which is connected to the destination switch. The native VLAN of the port should not be configured as RSPAN VLAN, or the mirrored data may not be carried by the destination switch.

RSPAN VLAN is 5.

```
XGS3-42000R(config)#vlan 5
XGS3-42000R(config-Vlan5)#remote-span
XGS3-42000R(config-Vlan5)#exit
XGS3-42000R(config)#interface ethernet 1/6-7
XGS3-42000R(config-If-Port-Range)#switchport mode trunk
XGS3-42000R(config-If-Port-Range)#exit
```

Destination switch:

Interface ethernet1/9 is the source port which is connected to the source switch.

Interface ethernet1/10 is the destination port which is connected to the monitor. This port is required to be configured as an access port, and belong to the RSPAN VLAN.

RSPAN VLAN is 5.

```
XGS3-42000R(config)#vlan 5
XGS3-42000R(config-Vlan5)#remote-span
XGS3-42000R(config-Vlan5)#exit
XGS3-42000R(config)#interface ethernet 1/9
XGS3-42000R(config-If-Ethernet1/9)#switchport mode trunk
XGS3-42000R(config-If-Ethernet1/9)#exit
XGS3-42000R(config)#interface ethernet 1/10
XGS3-42000R(config-If-Ethernet1/10)#switchport access vlan 5
XGS3-42000R(config-If-Ethernet1/10)#exit
```

56.4 RSPAN Troubleshooting

Due to the following reasons, RSPAN may not function:

- Whether the destination mirror port is a member of the Port-channel group. If so, please change the Port-channel group configuration;
- The throughput the destination port is less than the total throughput of the source mirror ports. If so, the destination cannot catch all the datagrams from every source ports. To solve the problem, please reduce the number of the source ports, or mirror only single direction data flow, or choose some other port with higher capacity as the destination port.
- Between the source switch and the intermediate switch, whether the native VLAN of the TRUNK ports is configured as RSPAN VLAN. If so, please change the native VLAN for the TRUNK ports.

Chapter 57 sFlow Configuration

57.1 Introduction to sFlow

The sFlow (RFC 3176) is a protocol based on standard network export and used on monitoring the network traffic information developed by the InMon Company. The monitored switch or router sends data to the client analyzer through its main operations such as sampling and statistic, then the analyzer will analyze according to the user requirements so to monitor the network.

A sFlow monitor system includes: sFlow proxy, central data collector and sFlow analyzer. The sFlow proxy collects data from the switch using sampling technology. The sFlow collector is for formatting the sample data statistic which is to be forwarded to the sFlow analyzer which will analyze the sample data and perform corresponding measure according to the result. Our switch here acts as the proxy and central data collector in the sFlow system. We have achieved data sampling and statistic targeting physical port.

Our data sample includes the IPv4 and IPv6 packets. Extensions of other types are not supported so far. As for non IPv4 and IPv6 packet, the unify HEADER mode will be adopted following the requirements in RFC3176, copying the head information of the packet based on analyzing the type of its protocol.

The latest sFlow protocol presented by InMon Company is the version 5. Since it is the version 4 which is realized in the RFC3176, version conflict might exist in some case such as the structure and the packet format. This is because the version 5 has not become the official protocol, so, in order to be compatible with current applications, we will continue to follow the RFC3176.

57.2 sFlow Configuration Task List

1. Configure sFlow Collector address

Command	Explanation
Global mode and Port Mode	
sflow destination <collector-address> [<collector-port>] no sflow destination	Configure the IP address and port number of the host in which the sFlow analysis software is installed. As for the ports, if IP address is configured on the port, the port configuration will be applied, or else will be applied the global configuration. The “ no sflow destination ” command restores to the default port value and deletes the IP address.

2. Configure the sFlow proxy address

Command	Explanation
Global Mode	
sflow agent-address <collector-address> no sflow agent-address	Configure the source IP address applied by the sFlow proxy; the “no” form of the command deletes this address.

3. Configure the sFlow proxy priority

Command	Explanation
Global Mode	
sflow priority <priority-value> no sflow priority	Configure the priority when sFlow receives packet from the hardware; the “ no sflow priority ” command restores to the default

4. Configure the packet head length copied by sFlow

Command	Explanation
Port Mode	
sflow header-len <length-value> no sflow header-len	Configure the length of the packet data head copied in the sFlow data sampling; the “no” form of this command restores to the default value.

5. Configure the max data head length of the sFlow packet

Command	Explanation
Port Mode	
sflow data-len <length-value> no sflow data-len	Configure the max length of the data packet in sFlow; the “no” form of this command restores to the default.

6. Configure the sampling rate value

Command	Explanation
Port Mode	
sflow rate {input <input-rate> output <output-rate >} no sflow rate [input output]	Configure the sampling rate when sFlow performing hardware sampling. The “no” command deletes the rate value.

7. Configure the sFlow statistic sampling interval

Command	Explanation
Port Mode	
sflow counter-interval <interval-value> no sflow counter-interval	Configure the max interval when sFlow performing statistic sampling. The “no” form of this command deletes

57.3 sFlow Examples

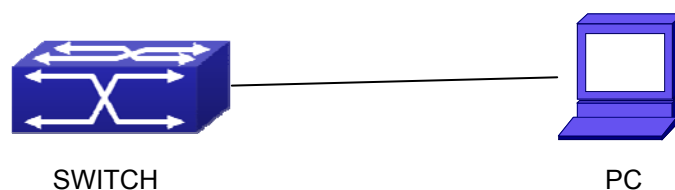

Figure 57-3-1 sFlow configuration topology

As shown in the figure, sFlow sampling is enabled on the port 1/1 and 1/2 of the switch. Assume the sFlow analysis software is installed on the PC with the address of 192.168.1.200. The address of the layer 3 interface on the SwitchA connected with PC is 192.168.1.100. A loopback interface with the address of 10.1.144.2 is configured on the SwitchA. sFlow configuration is as follows:

Configuration procedure is as follows:

```
XGS3-42000R#config
XGS3-42000R(config)#sflow ageng-address 10.1.144.2
XGS3-42000R(config)#sflow destination 192.168.1.200
XGS3-42000R(config)#sflow priority 1
XGS3-42000R(config)# interface ethernet1/1
XGS3-42000R(Config-If-Ethernet1/1)#sflow rate input 10000
XGS3-42000R(Config-If-Ethernet1/1)#sflow rate output 10000
XGS3-42000R(Config-If-Ethernet1/1)#sflow counter-interval 20
XGS3-42000R(Config-If-Ethernet1/1)#exit
XGS3-42000R(config)# interface ethernet1/2
XGS3-42000R(Config-If-Ethernet1/2)#sflow rate input 20000
XGS3-42000R(Config-If-Ethernet1/2)#sflow rate output 20000
XGS3-42000R(Config-If-Ethernet1/2)#sflow counter-interval 40
```

57.4 sFlow Troubleshooting

In configuring and using sFlow, the sFlow server may fail to run properly due to physical connection failure, wrong configuration, etc. The user should ensure the following:

- Ensure the physical connection is correct
- Guarantee the address of the sFlow analyzer configured under global or port mode is accessible.
- If traffic sampling is required, the sampling rate of the interface must be configured
- If statistic sampling is required, the statistic sampling interval of the interface must be configured

If the examination remains unsolved, please contact with the technical service center of our company.

Chapter 58 VRRP Configuration

58.1 Introduction to VRRP

VRRP (Virtual Router Redundancy Protocol) is a fault tolerant protocol designed to enhance connection reliability between routers (or L3 Ethernet switches) and external devices. It is developed by the IETF for local area networks (LAN) with multicast/broadcast capability (Ethernet is a Configuration Example) and has wide applications.

All hosts in one LAN generally have a default route configured to specified default gateway, any packet destined to an address outside the native segment will be sent to the default gateway via this default route. These hosts in the LAN can communicate with the external networks. However, if the communication link connecting the router serving as default gateway and external networks fails, all hosts using that gateway as the default next hop route will be unable to communicate with the external networks.

VRRP emerged to resolve such problem. VRRP runs on multiple routers in a LAN, simulating a "virtual" router (also referred to as a "Standby cluster") with the multiple routes. There is an active router (the "Master") and one or more backup routers (the "Backup") in the Standby cluster. The workload of the virtual router is actually undertaken by the active router, while the Backup routers serve as backups for the active router.

The virtual router has its own "virtual" IP address (can be identical with the IP address of some router in the Standby cluster), and routers in the Standby cluster also have their own IP address. Since VRRP runs on routers or Ethernet Switches only, the Standby cluster is transparent to the hosts with the segment. To them, there exists only the IP address of the Virtual Router instead of the actual IP addresses of the Master and Backup(s). And the default gateway setting of all the hosts uses the IP address of the Virtual Router. Therefore, hosts within the LAN communicate with the other networks via this Virtual Router. But basically, they are communicating with the other networks via the Master. In the case when the Master of the Standby cluster fails, a backup will take over its task and become the Master to serve all the hosts in the LAN, so that uninterrupted communication between LAN hosts and external networks can be achieved.

To sum it up, in a VRRP Standby cluster, there is always a router/Ethernet serving as the active router (Master), while the rest of the Standby cluster servers act as the backup router(s) (Backup, can be multiple) and monitor the activity of Master all the time. Should the Master fail, a new Master will be elected by all the Backups to take over the work and continue serving the hosts within the segment. Since the election and take-over duration is brief and smooth, hosts within the segment can use the Virtual Router as normal and uninterrupted communication can be achieved.

58.2 VRRP Configuration Task List

Configuration Task List:

1. Create/Remove the Virtual Router (required)
2. Configure VRRP dummy IP and interface (required)
3. Activate/Deactivate Virtual Router (required)
4. Configure VRRP sub-parameters (optional)
 - (1) Configure the preemptive mode for VRRP
 - (2) Configure VRRP priority
 - (3) Configure VRRP Timer intervals
 - (4) Configure VRRP interface monitor

1. Create/Remove the Virtual Router

Command	Explanation
Global Mode	
router vrrp <vrid> no router vrrp <vrid>	Creates/Removes the Virtual Router.

2. Configure VRRP Dummy IP Address and Interface

Command	Explanation
VRRP protocol configuration mode	
virtual-ip <ip> no virtual-ip	Configures VRRP Dummy IP address; the " no virtual-ip " command removes the virtual IP address.
interface {IFNAME ethernet IFNAME Vlan <ID> } no interface	Configures VRRP interface, the " no interface " command removes the interface.

3. Activate/Deactivate Virtual Router

Command	Explanation
VRRP protocol configuration mode	
enable	Activates the Virtual Router.
disable	Deactivates the Virtual Router.

4. Configure VRRP Sub-parameters

(1) Configure the preemptive mode for VRRP

Command	Explanation
VRRP protocol configuration mode	
preempt-mode {true false}	Configures the preemptive mode for VRRP.

(2) Configure VRRP priority

Command	Explanation
VRRP protocol configuration mode	
priority <priority>	Configures VRRP priority.

(3) Configure VRRP Timer intervals

Command	Explanation
VRRP protocol configuration mode	
advertisement-interval <time>	Configures VRRP timer value (in seconds).

(4) Configure VRRP interface monitor

Command	Explanation
VRRP protocol configuration mode	
circuit-failover {IFNAME ethernet IFNAME Vlan <ID> } <value_reduced> no circuit-failover	Configures VRRP interface monitor, the " no circuit-failover " removes monitor to the interface.

58.3 VRRP Typical Examples

As shown in the figure below, SwitchA and SwitchB are Layer three Ethernet Switches in the same group and provide redundancy for each other.

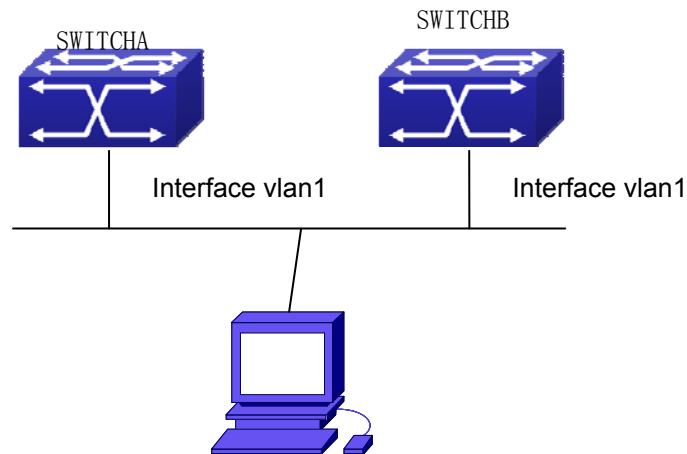

Figure 58-3-1 VRRP Network Topology

Configuration of SwitchA:

```
SwitchA(config)#interface vlan 1
SwitchA (Config-if-Vlan1)# ip address 10.1.1.1 255.255.255.0
SwitchA (config)#router vrrp 1
SwitchA(Config-Router-Vrrp)# virtual-ip 10.1.1.5
SwitchA(Config-Router-Vrrp)# interface vlan 1
SwitchA(Config-Router-Vrrp)# enable
```

Configuration of SwitchB:

```
SwitchB(config)#interface vlan 1
SwitchB (Config-if-Vlan1)# ip address 10.1.1.7 255.255.255.0
SwitchB(config)#router vrrp 1
SwitchB (Config-Router-Vrrp)# virtual-ip 10.1.1.5
SwitchB(Config-Router-Vrrp)# interface vlan 1
SwitchB(Config-Router-Vrrp)# enable
```

58.4 VRRP Troubleshooting

In configuring and using VRRP protocol, the VRRP protocol may fail to run properly due to reasons such as physical connection failure or wrong configurations. The user should ensure the following:

- Good condition of the physical connection.
- All interface and link protocols are in the UP state (use “**show interface**” command).
- Ensure VRRP is enabled on the interface. Verify the authentication mode of different routers (or L3 Ethernet switches) in the same standby cluster are the same.
- Verify the timer time of different routers (or L3 Ethernet switches) in the same standby cluster are the same.
- Verify the dummy IP address is in the same network segment of the interface’s actual IP address.
- If the examination remains unsolved, please use **debug vrrp** and other debugging command and copy the DEBUG message within 3 minutes, send the recorded message to the technical server center of our company.

Chapter 59 IPv6 VRRPv3 Configuration

59.1 Introduction to VRRPv3

VRRPv3 is a virtual router redundancy protocol for IPv6. It is designed based on VRRP (VRRPv2) in IPv4 environment. The following is a brief introduction to it.

In a network based on TCP/IP protocol, in order to guarantee the communication between the devices which are not physically connected, routers should be specified. At present there are two most commonly used methods to specify routers: one is to study dynamically via routing protocols (such as internal routing protocols RIP and OSPF); the other is to configure statically. Running dynamical routing protocol on each terminal is unrealistic, since most operating systems for client end do not support dynamical routing protocol, even if they do, they are limited by the overheads of management, convergence, security and many other problems. So the common method is to adopt static routing configuration on terminal IP devices, which usually means specify one or more default gateway for terminal devices. Static routing simplifies the management of network and reduces the communication overheads of terminal devices, but it still has a disadvantage: if the router acting as the default gateway breaks, the communication of all the hosts which use this gateway as their next hop host. Even if there are more than one default gateways, before rebooting the terminal devices, they can not switch to the new gateway. Adopting virtual router redundancy protocol (VRPR) can effectively avoid the flaws of statically specifying gateways.

In VRRP protocol, there are two groups of import concepts: VRRP routers and virtual routers, master routers and backup routers. VRRP routers are routers running VRRP, which are physical entities; virtual routers are the ones created by VRRP, which are logical concepts. A group of VRRP routers cooperate to comprise a virtual router, which acts outwardly as a logical router with a unique fixed IP address and MAC address. The routers belonging to the same VRRP group play two mutually exclusive roles at the same time: master routers and backup routers. One VRRP group can only have one master router other but one or more backup routers. VRRPv3 protocol uses selection policy to select a master router from the router group to take charge of responding ND(Neighbor Discovery) neighbor request messages(ARP in IPv4) and forwarding IP data packets, while the other routers in the group will be in a state of waiting as backups. When the master router has a problem for some season, the backup router will be updated to the master router after a delay of a few seconds. Since this switch is very fast and does not need to change IP address or MAC address, it will be transparent to terminal user systems.

In IPv6 environment, the hosts in a LAN usually learn the default gateway via neighbor discovery protocol (NDP), which is implemented based on regularly receiving advertisement messages from routers. The NDP of IPv6 has a mechanism called Neighbor Unreachability Detection, which checks whether a neighbor node is failed by sending unicast neighbor request messages to it. In order to reduce the overheads of sending neighbor request messages, these messages are only sent to those neighbor nodes which are sending flows, and are only sent if there is no instruction of UP state of the router in a period of time. In Neighbor Unreachability Detection, if adopting default parameters, it will take about 38 seconds to detect an unreachable router, which is a delay not ignorable for users and might cause a time-out in some transport

protocols. Compared with NDP, VRRP provides a fast default gateway switch. In VRRP, backup routers can take up the unavailable master router in about 3 seconds (default parameter), and this process needs no interaction with hosts, which means being transparent to hosts.

59.1.1 The Format of VRRPv3 Message

VRRPv3 has its own message format, VRRP messages are used to communicate the priority of routers and the state of Master in the backup group, they are encapsulated in IPv6 messages to send, and are sent to the specified IPv6 multicast address. The format of VRRPv3 message is shown in Graph 1. The source address of the IPv6 message encapsulating the VRRPv3 message is the local address of the outbound interface of the message, and the destination address of it is the IPv6 multicast address(the multicast allocated to VRRPv3 is FF02:0:0:0:0:0:12). The number of hops should be limited to 255, and the next message head is 112(representing a VRRP message).

The meaning of each field in a VRRPv3 message is shown as follows:

Version: The version of VRRPv3, whose value is 3;

Type: The type of VRRP messages. There is only one type: ADVERTISEMENT, and its value is 1;

Virtual Rtr ID : The ID of the virtual router;

Priority : Priority, ranging from 0 to 255;

Count IPv6 Addr : The number of IPv6 addresses in a VRRPv3 message, the minimum of which is 1;

Rsvd : Reserved field, whose value is 0;

Adver Int : The advertisement interval of VRRPv3 messages, in seconds;

Checksum : The checksum, taking account of the whole VRRPv3 message and an IPv6 pseudo head (please refer to RFC2460 for details);

IPv6 Address(es) : one or more IPv6 addresses related to the virtual router, the number of which is the same with "Count IPv6 Addr", and the first one of which should be the virtual IPv6 address of the virtual router.

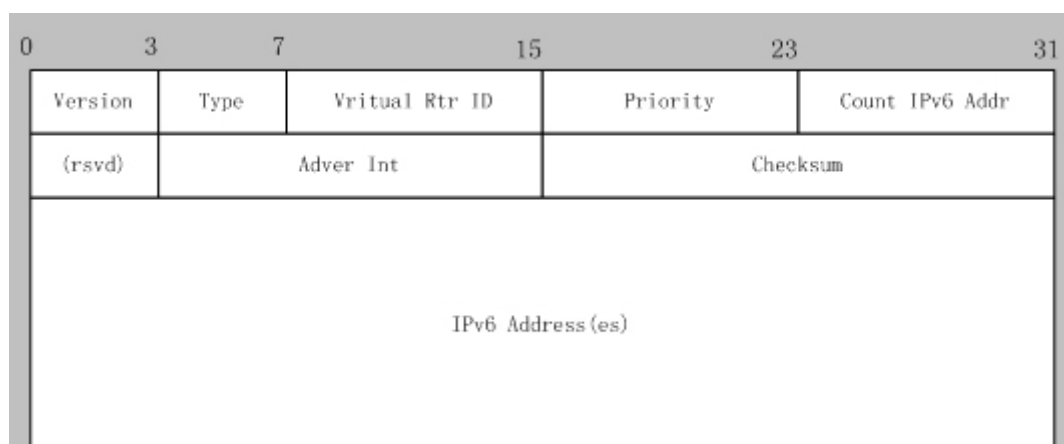

Figure 59-1-1 VRRPv3 message

59.1.2 VRRPv3 Working Mechanism

The working mechanism of VRRPv3 is the same with that of VRRPv2, which is mainly implemented via the interaction of VRRP advertisement messages. It will be briefly described as follows:

Each VRRP router has a unique ID: VRID, ranging from 1 to 255. This router has a unique virtual MAC address outwardly, and the format of which is 00-00-5E-00-02- $\{VRID\}$ (the format of virtual MAC address in VRRPv2 is 00-00-5E-00-01- $\{VRID\}$). Master router is in charge of using this MAC address to respond to ND neighbor request (it is ARP request in VRRPv2). Thus, no matter what switch is made, the terminal devices will get the same IP and MAC address all the time, reducing the affection that the switch causes on terminal devices.

There is only one kind of VRRP control message: VRRP advertisement. It uses IP multicast data packets to encapsulate, and the format of multicast addresses is FF02:0:0:0:0:XXXX:XXXX. In order to keep a consistence with the multicast address in VRRPv2 (224.0.0.18), the multicast addresses used by VRRPv3 advertisement messages can be FF02:0:0:0:0:0:12, and the advertisement is limited within the same LAN. Thus, different VRID are guaranteed to be used repeatedly in different networks. In order to reduce the overheads of network bandwidth, only master routers can send VRRP advertisement messages regularly. Backup routers will start a new round of VRRP selection if it hasn't received a VRRP advertisement in 3 advertisement intervals in a row or if it receives an advertisement with a priority of 0.

In a VRRP router group, the master router is selected according to priority. The range of priority in VRRP protocol is 0-255. If the IP address of a VRRP router is the same to that of the virtual router interface, then the virtual router will be called the IP address owner in the VRRP group; the IP address owner automatically has the highest priority: 255. The priority of 0 is usually used when the IP address owner gives up the role of master. The range of priority can be configured is 1-254. The configuration rule of priority can be set according to the speed and cost of the link, the performance and reliability of the router and other management policies. In the selection of the master router, the virtual router with high priority will win. So, if there is an IP owner in the VRRP group, it will always be the master router. For the candidate routers having the same priority, selection will be done according to the magnitude of IP addresses (the bigger IP address takes precedence). VRRP also provides a preemptive priority policy. If such policy is configured, the backup router with higher priority will preempt the role of new master router over the current master router with lower priority.

In order to avoid the fault of returning a physical MAC address when Pinging virtual IP, it is regulated that virtual IP can not be the real IP of the interface. Thus, all the interfaces participating in the backup group selection will be back up by default.

59.2 VRRPv3 Configuration

59.2.1 Configuration Task Sequence

1. Create/delete the virtual router (necessary)
2. Configure the virtual IPv6 address and interface of VRRPv3 (necessary)
3. Enable/disable the virtual router (necessary)
4. Configure VRRPv3 assistant parameters (optional)
 - (1) Configure VRRPv3 preempt mode
 - (2) Configure VRRPv3 priority
 - (3) Configure the VRRPv3 advertisement interval
 - (4) Configure the monitor interface of VRRPv3

1. Create/delete the virtual router

Command	Explanation
Global Configuration Mode	
router ipv6 vrrp <vrid> no router ipv6 vrrp <vrid>	Create/delete the virtual router.

2. Configure the virtual IPv6 address and interface of VRRPv3

Command	Explanation
VRRPv3 Protocol Mode	
virtual-ipv6 <ipv6-address> Interface {Vlan <ID> IFNAME } no virtual-ipv6 interface	Configure the virtual IPv6 address and interface of VRRPv3, the no operation of this command will delete the virtual IPv6 address and interface.

3. Enable/disable the virtual router

Command	Explanation
VRRPv3 Protocol Mode	
enable	Enable the virtual router.
disable	Disable the virtual router.

4. Configure VRRPv3 assistant parameters

(1) Configure VRRPv3 preempt mode

Command	Explanation
VRRPv3 Protocol Mode	
preempt-mode {true false}	Configure VRRPv3 preempt mode.

(2) Configure VRRPv3 priority

Command	Explanation
VRRPv3 Protocol Mode	
priority < priority >	Configure VRRPv3 priority.

(3) Configure the VRRPv3 advertisement interval

Command	Explanation
VRRPv3 Protocol Mode	
advertisement-interval <time>	Configure the VRRPv3 advertisement interval (in cent seconds).

(4) Configure the monitor interface of VRRPv3

Command	Explanation
VRRPv3 Protocol Mode	
circuit-failover {vlan <ID> IFNAME} <value_reduced> no circuit-failover	Configure the monitor interface of VRRPv3, the no operation of this command will delete the monitor interface.

59.3 VRRPv3 Typical Examples

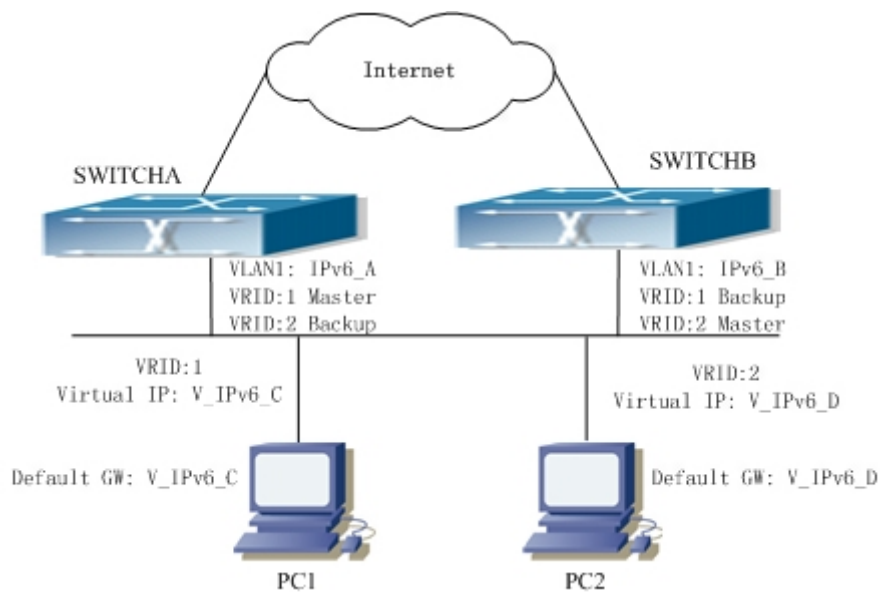

Figure 59-3-1 VRRPv3 Typical Network Topology

As shown in graph, switch A and switch B are backups to each other, switch A is the master of backup group 1 and a backup of backup group 2. Switch B is the master of backup group 2 and a Backup of backup group 1. The IPv6 addresses of switch A and switch B are "IPv6_A" and "IPv6_B" respectively (it is recommended that IPv6_A and IPv6_B are in the same segment), the virtual IPv6 address of backup group 1 and backup group are "V_IPv6_C" and "V_IPv6_D" respectively, and the default IPv6 gateway address are configured as "V_IPv6_C" and "V_IPv6_D" respectively (in reality, the IPv6 gateway address of hosts are usually learnt automatically via router advertisements, thus, the IPv6 next hop of the hosts will have some randomness). Doing this will not only implement router backup but also the flow sharing function in the LAN.

The configuration of SwitchA:

```
SwitchA (config)#ipv6 enable
SwitchA (config)#interface vlan 1
SwitchA (config)#router ipv6 vrrp 1
SwitchA (config-router)#virtual-ipv6 fe80::2 interface vlan 1
SwitchA (config-router)#priority 150
SwitchA (config-router)#enable
SwitchA (config)#router ipv6 vrrp 2
SwitchA (config-router)#virtual-ipv6 fe80::3 interface vlan 1
SwitchA (config-router)#enable
```

The configuration of SwitchB:

```
SwitchB (config)# ipv6 enable
SwitchB (config)# interface vlan 1
SwitchB (config)# router ipv6 vrrp 2
SwitchB (config-router)# virtual-ipv6 fe80::3 interface vlan 1
SwitchB (config-router)# priority 150
SwitchB (config-router)# enable
SwitchB (config)# router ipv6 vrrp 1
SwitchB (config-router)# virtual-ipv6 fe80::2 interface vlan 1
SwitchB (config-router)# enable
```

59.4 VRRPv3 Troubleshooting

When configuring and using VRRPv3 protocol, it might operate abnormally because of incorrect physical connections and configuration. So, users should pay attention to the following points:

- First, the physical connections should be correct;
- Next, the interface and link protocol are UP (use **show ipv6 interface** command);
- And then, make sure that IPv6 forwarding function is enabled (use **ipv6 enable** command);
- Besides, make sure that VRRPv3 protocol is enable on the interface;
- Check whether the time of timer in different routers (or layer-three Ethernet switch) within the same backup group is the same;
- Check whether the virtual IPv6 addresses in the same backup group is the same.

Chapter 60 MRPP Configuration

60.1 Introduction to MRPP

MRPP (Multi-layer Ring Protection Protocol), is a link layer protocol applied on Ethernet loop protection. It can avoid broadcast storm caused by data loop on Ethernet ring, and restore communication among every node on ring network when the Ethernet ring has a break link. MRPP is the expansion of EAPS (Ethernet link automatic protection protocol).

MRPP protocol is similar to STP protocol on function, MRPP has below characters, compare to STP protocol:

- <1> MRPP specifically uses to Ethernet ring topology
- <2> fast convergence, less than 1 s. ideally it can reach 100-50 ms.

60.1.1 Conception Introduction

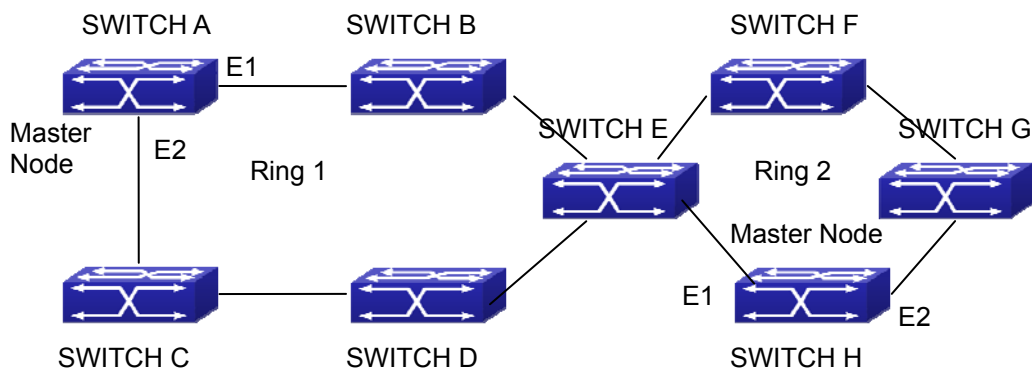

Figure 60-1-1 MRPP Sketch Map

1. Control VLAN

Control VLAN is a virtual VLAN, only used to identify MRPP protocol packet transferred in the link. To avoid confusion with other configured VLAN, avoids configuring control VLAN ID to be the same with other configured VLAN ID. The different MRPP ring should configure the different control VLAN ID.

2. Ethernet Ring (MRPP Ring)

Ring linked Ethernet network topology.

Each MRPP ring has two states.

Health state: The whole ring network physical link is connected.

Break state: one or a few physical link break in ring network

3. nodes

Each switch is named after a node on Ethernet. The node has some types:

Primary node: each ring has a primary node, it is main node to detect and defend.

Transfer node: except for primary node, other nodes are transfer nodes on each ring.

The node role is determined by user configuration. As shown above, Switch A is primary node of Ring 1, Switch B. Switch C; Switch D and Switch E are transfer nodes of Ring 1.

4. Primary port and secondary port

The primary node and transfer node have two ports connecting to Ethernet separately, one is primary port, and another is secondary port. The role of port is determined by user configuration.

Primary port and secondary port of primary node

The primary port of primary node is used to send ring health examine packet (hello), the secondary port is used to receive Hello packet sending from primary node. When the Ethernet is in health state, the secondary port of primary node blocks other data in logical and only MRPP packet can pass. When the Ethernet is in break state, the secondary port of primary node releases block state, and forwards data packets.

There are no difference on function between Primary port and secondary port of transfer node.

The role of port is determined by user configuration. As shown in above, Switch A E1 is primary port, E2 is secondary port.

5. Timer

The two timers are used when the primary node sends and receives MRPP protocol packet: Hello timer and Fail Timer.

Hello timer: define timer of time interval of health examine packet sending by primary node primary port.

Fail timer: define timer of overtime interval of health examine packet receiving by primary node primary port.

The value of Fail timer must be more than or equal to the 3 times of value of Hello timer.

60.1.2 MRPP Protocol Packet Types

Packet Type	Explanation
Hello packet (Health examine packet) Hello	The primary port of primary node evokes to detect ring, if the secondary port of primary node can receive Hello packet in configured overtime, so the ring is normal.
LINK-DOWN (link Down event packet)	After transfer node detects Down event on port, immediately sends LINK-DOWN packet to primary node, and inform primary node ring to fail.
LINK-DOWN-FLUSH_FDB packet	After primary node detects ring failure or receives LINK-DOWN packet, open blocked secondary port, and then uses two ports to send the packet, to inform each transfer node to refresh own MAC address.
LINK-UP-FLUSH_FDB packet	After primary detects ring failure to restore normal, and uses packet from primary port, and informs each transfer node to refresh own MAC address.

60.1.3 MRPP Protocol Operation System

1. Link Down Alarm System

When transfer node finds themselves belonging to MRPP ring port Down, it sends link Down packet to primary node immediately. The primary node receives link down packet and immediately releases block state of secondary port, and sends LINK-DOWN-FLUSH-FDB packet to inform all of transfer nodes, refreshing own MAC address forward list.

2. Poll System

The primary port of primary node sends Hello packet to its neighbors timely according to configured Hello-timer.

If the ring is health, the secondary port of primary node receives health detect packet, and the primary node keeps secondary port.

If the ring is break, the secondary port of primary node can't receive health detect packet when timer is over time. The primary releases the secondary port block state, and sends LINK-DOWN-FLUSH_FDB packet to inform all of transfer nodes, to refresh own MAC address forward list.

3. Ring Restore

After the primary node occur ring fail, if the secondary port receives Hello packet sending from primary node, the ring has been restored, at the same time the primary node block its secondary port, and sends its neighbor LINK-UP-Flush-FDB packet.

After MRPP ring port refresh UP on transfer node, the primary node maybe find ring restore after a while. For the normal data VLAN, the network maybe forms a temporary ring and creates broadcast storm. To avoid temporary ring, transfer node finds it to connect to ring network port to refresh UP, immediately block temporarily (only permit control VLAN packet pass), after only receiving LINK-UP-FLUSH-FDB packet from primary node, and releases the port block state.

60.2 MRPP Configuration Task List

- 1) Globally enable MRPP
- 2) Configure MRPP ring
- 3) Display and debug MRPP relevant information

1) Globally enable MRPP

Command	Explanation
Global Mode	
mrpp enable no mrpp enable	Globally enable and disable MRPP.

2) Configure MRPP ring

Command	Explanation
Global Mode	
mrpp ring <ring-id> no mrpp ring <ring-id>	Create MRPP ring. The “no” command deletes MRPP ring and its configuration.
MRPP ring mode	
control-vlan <vid> no control-vlan	Configure control VLAN ID, format “no” deletes configured control VLAN ID.
node-mode {master transit}	Configure node type of MRPP ring (primary node or secondary node).
hello-timer <timer> no hello-timer	Configure Hello packet timer sending from primary node of MRPP ring, format “no” restores default timer value.
fail-timer <timer> no fail-timer	Configure Hello packet overtime timer sending from primary node of MRPP ring, format “no” restores default timer value.
enable no enable	Enable MRPP ring, format “no” disables enabled MRPP ring.
Port mode	
mrpp ring <ring-id> primary-port no mrpp ring <ring-id> primary-port	Specify primary port of MRPP ring.
mrpp ring <ring-id> secondary-port no mrpp ring <ring-id> secondary-port	Specify secondary port of MRPP ring.

3) Display and debug MRPP relevant information

Command	Explanation
Admin Mode	
debug mrpp no debug mrpp	Disable MRPP module debug information, format “no” disable MRPP debug information output.
show mrpp {<ring-id>}	Display MRPP ring configuration information.
show mrpp statistics {<ring-id>}	Display receiving data packet statistic information of MRPP ring.
clear mrpp statistics {<ring-id>}	Clear receiving data packet statistic information of MRPP ring.

60.3 MRPP Typical Scenario

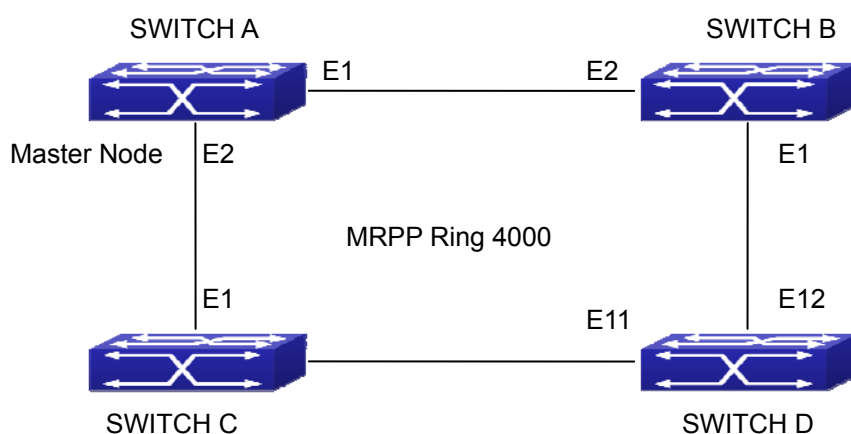

Figure 60-3-1 MRPP typical configuration scenario

The above topology often occurs on using MRPP protocol. The multi switch constitutes a single MRPP ring, all of the switches only are configured an MRPP ring 4000, thereby constitutes a single MRPP ring.

In above configuration, SWITCH A configuration is primary node of MRPP ring 4000, and configures E1/1 to primary port, E1/2 to secondary port. Other switches are secondary nodes of MRPP ring, configures primary port and secondary port separately.

To avoid ring, it should temporarily disable one of the ports of primary node, when it enables each MRPP ring in the whole MRPP ring; and after all of the nodes are configured, open the port.

When disable MRPP ring, it needs to insure the MRPP ring doesn't have ring.

SWITCH A configuration Task Sequence:

```
XGS3-42000R(config)#mrpp enable
XGS3-42000R(config)#mrpp ring 4000
XGS3-42000R(mrpp-ring-4000)#control-vlan 4000
XGS3-42000R(mrpp-ring-4000)#fail-timer 18
XGS3-42000R(mrpp-ring-4000)#hello-timer 5
XGS3-42000R(mrpp-ring-4000)#node-mode master
XGS3-42000R(mrpp-ring-4000)#enable
XGS3-42000R(mrpp-ring-4000)#exit
XGS3-42000R(config)#interface ethernet 1/1
XGS3-42000R(config-if-Ethernet1/1)#mrpp ring 4000 primary-port
XGS3-42000R(config-if-Ethernet1/1)#interface ethernet 1/2
XGS3-42000R(config-if-Ethernet1/2)#mrpp ring 4000 secondary-port
XGS3-42000R(config-if-Ethernet1/2)#exit
XGS3-42000R(config)#
```

SWITCH B configuration Task Sequence:

```
XGS3-42000R(config)#mrpp enable
XGS3-42000R(config)#mrpp ring 4000
XGS3-42000R(mrpp-ring-4000)#control-vlan 4000
XGS3-42000R(mrpp-ring-4000)#enable
XGS3-42000R(mrpp-ring-4000)#exit
XGS3-42000R(config)#interface ethernet 1/1
XGS3-42000R(config-If-Ethernet1/1)#mrpp ring 4000 primary-port
XGS3-42000R(config-If-Ethernet1/1)#interface ethernet 1/2
XGS3-42000R(config-If-Ethernet1/2)#mrpp ring 4000 secondary-port
XGS3-42000R(config-If-Ethernet1/2)#exit
XGS3-42000R(config)#
```

SWITCH C configuration Task Sequence:

```
XGS3-42000R(config)#mrpp enable
XGS3-42000R(config)#mrpp ring 4000
XGS3-42000R(mrpp-ring-4000)#control-vlan 4000
XGS3-42000R(mrpp-ring-4000)#enable
XGS3-42000R(mrpp-ring-4000)#exit
XGS3-42000R(config)#interface ethernet 1/1
XGS3-42000R(config-If-Ethernet1/1)#mrpp ring 4000 primary-port
XGS3-42000R(config-If-Ethernet1/1)#interface ethernet 1/2
XGS3-42000R(config-If-Ethernet1/2)#mrpp ring 4000 secondary-port
XGS3-42000R(config-If-Ethernet1/2)#exit
XGS3-42000R(config)#
```

SWITCH D configuration Task Sequence:

```
XGS3-42000R(config)#mrpp enable
XGS3-42000R(config)#mrpp ring 4000
XGS3-42000R(mrpp-ring-4000)#control-vlan 4000
XGS3-42000R(mrpp-ring-4000)#enable
XGS3-42000R(mrpp-ring-4000)#exit
XGS3-42000R(config)#interface ethernet 1/1
XGS3-42000R(config-If-Ethernet1/1)#mrpp ring 4000 primary-port
XGS3-42000R(config-If-Ethernet1/1)#interface ethernet 1/2
XGS3-42000R(config-If-Ethernet1/2)#mrpp ring 4000 secondary-port
XGS3-42000R(config-If-Ethernet1/2)#exit
XGS3-42000R(config)#
```

60.4 MRPP Troubleshooting

The normal operation of MRPP protocol depends on normal configuration of each switch on MRPP ring, otherwise it is very possible to form ring and broadcast storm:

- Configuring MRPP ring, you'd better disconnected the ring, and wait for each switch configuration, then open the ring.
- When the MRPP ring of enabled switch is disabled on MRPP ring, it ensures the ring of the MRPP ring has been disconnected.
- When there is broadcast storm on MRPP ring, it disconnects the ring firstly, and ensures if each switch MRPP ring configuration on the ring is correct or not; if correct, restores the ring, and then observes the ring is normal or not.
- In normal configuration, it still forms ring broadcast storm or ring block, please open debug function of primary node MRPP, and used show MRPP statistics command to observe states of primary node and transfer node and statistics information is normal or not, and then sends results to our Technology Service Center.

Chapter 61 ULPP Configuration

61.1 Introduction to ULPP

Each ULPP group has two uplink ports, they are master port and slave port. The port may be a physical port or a port channel. The member ports of ULPP group have three states: Forwarding, Standby, Down. Normally, only one port at the forwarding state, the other port is blocked at the Standby state. When the master port has the link problem, the master port becomes down state, and the slave port is switched to forwarding state.

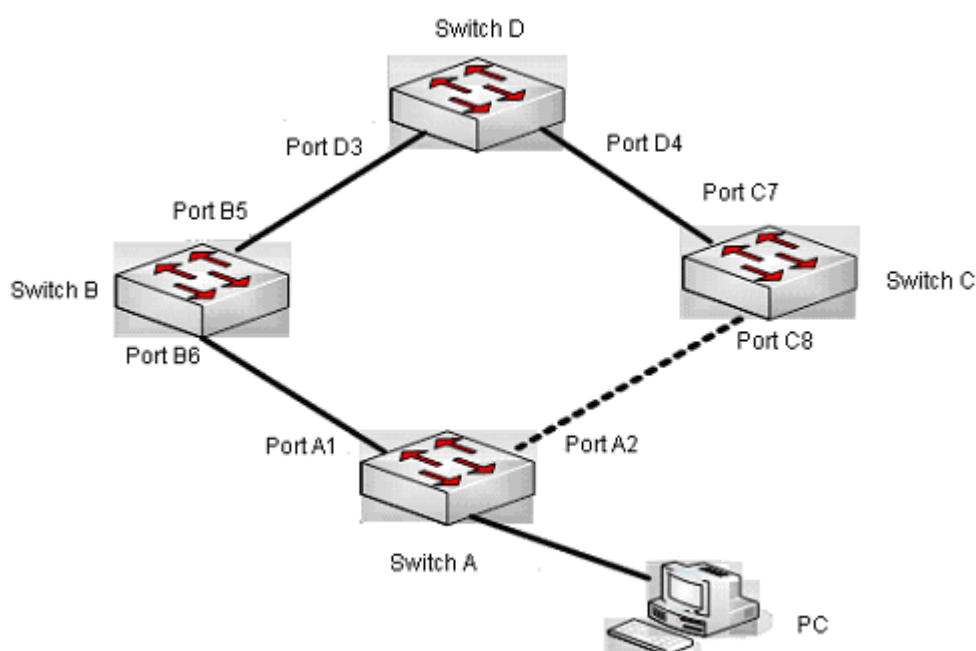

Figure 61-1-1 the using scene of ULPP

The above figure uses the double-uplink network, this is the typical application scene of ULPP. SwitchA goes up to SwitchD through SwitchB and SwitchC, port A1 and port A2 are the uplink ports. SwitchA configures ULPP, thereinto port A1 is set as the master port, port A2 is set as the slave port. When port A1 at forwarding state has the problem, switch the uplink at once, port A2 turns into forwarding state. After this, when recovering the master port, if the preemption mode is not configured, port A2 keeps the Forwarding state, port A1 turns into the Standby state.

After the preemption mode is enabled, so as to the master port preempts the slave port when it recovered from the problem. For avoiding the frequent uplink switch caused by the abnormality problem, the preemption delay mechanism is imported, and it needs to wait for some times before the master port preempt the slave port. For keeping the continuance of the flows, the master port does not process to preempt by default, but turns into the Standby state.

When configuring ULPP, it needs to specify the VLAN which is protected by this ULPP group through the method of MSTP instances, and ULPP does not provide the protection to other VLANs.

When the uplink switch is happening, the primary forwarding entries of the device will not be applied to new topology in the network. In the figure, SwitchA configures ULPP, the portA1 as the master port at forwarding state, here the MAC address of PC is learned by Switch D from portD3. After this, portA1 has the problem, the traffic is switched to portA2 to be forwarded. If there is the data sent to PC by SwitchD, still the data will be forwarded from portD3, and will be lost. Therefore, when switching the uplink, the device of configuring ULPP needs to send the flush packets through the port which is switched to Forwarding state, and update MAC address tables and ARP tables of other devices in the network. ULPP respectively uses two kinds of flush packets to update the entries: the updated packets of MAC address and the deleted packets of ARP.

For making use of the bandwidth resource enough, ULPP can implement VLAN load balance through the configuration. As the picture illustrated, SwitchA configures two ULPP groups: portA1 is the master port and portA2 is the slave port in group1, portA2 is the master port and portA1 is the slave port in group2, the VLANs are protected by group1 and group2, they are 1-100 and 101-200. Here both portA1 and portA2 at the forwarding state, the master port and the slave port mutually backup, and respectively forward the packets of the different VLAN ranges. When portA1 has the problem, the traffic of VLAN 1-200 are forwarded by portA2. After this, when portA1 is recovering the normal state, portA2 forwards the data of VLAN 101-200 sequentially, but the data of VLAN 1-100 is switched to portA1 to forward.

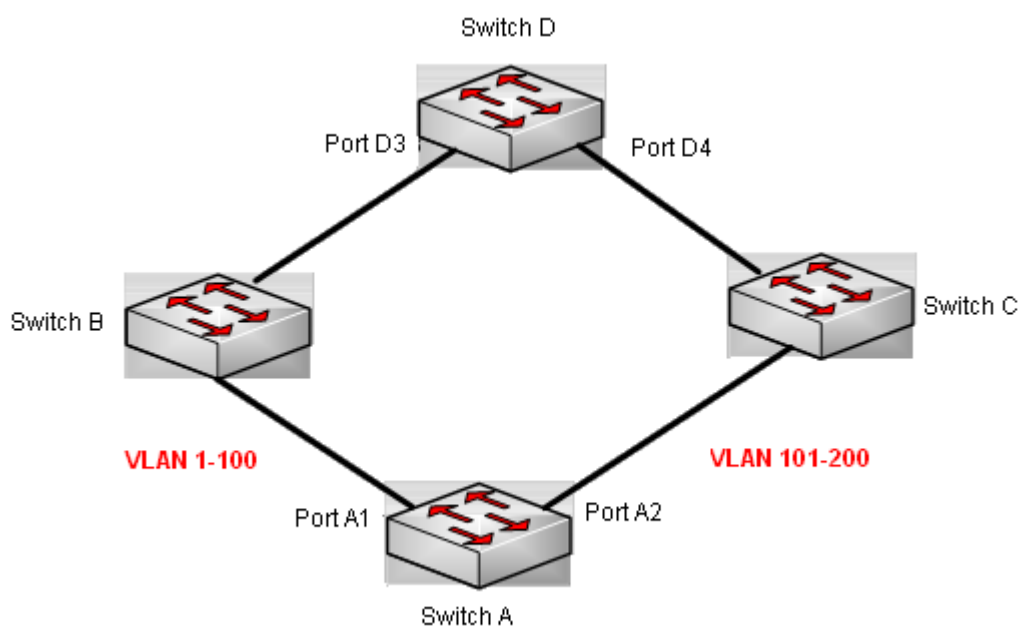

Figure 61-1-2 VLAN load balance

61.2 ULPP Configuration Task List

1. Create ULPP group globally
2. Configure ULPP group
3. Show and debug the relating information of ULPP

1. Create ULPP group globally

Command	Explanation
Global mode	
ulpp group <integer> no ulpp group <integer>	Configure and delete ULPP group globally.

2. Configure ULPP group

Command	Explanation
ULPP group configuration mode	
preemption mode no preemption mode	Configure the preemption mode of ULPP group. The no operation deletes the preemption mode.
preemption delay <integer> no preemption delay	Configure the preemption delay, the no operation restores the default value 30s.
control-vlan <integer> no control-vlan	Configure the sending control VLAN, no operation restores the default value 1.
protect vlan-reference-instance <instance-list> no protect vlan-reference-instance <instance-list>	Configure the protection VLANs, the no operation deletes the protection VLANs.
flush enable mac flush disable mac	Enable or disable sending the flush packets which update MAC address.
flush enable arp flush disable arp	Enable or disable sending the flush packets which delete ARP.
description <string> no description	Configure or delete ULPP group description.
Port mode	
ulpp control vlan <vlan-list> no ulpp control vlan <vlan-list>	Configure the receiving control VLANs, no operation restores the default value 1.
ulpp flush enable mac ulpp flush disable mac	Enable or disable receiving the flush packets which update the MAC address.
ulpp flush enable arp ulpp flush disable arp	Enable or disable receiving the flush packets which delete ARP.
ulpp group <integer> master no ulpp group <integer> master	Configure or delete the master port of ULPP group.
ulpp group <integer> slave no ulpp group <integer> slave	Configure or delete the slave port of ULPP group.

3. Show and debug the relating information of ULPP

Command	Explanation
Admin mode	
show ulpp group [group-id]	Show the configuration information of the configured ULPP group.
show ulpp flush counter interface <name>	Show the statistic information of the flush packets.
clear ulpp flush counter interface <name>	Clear the statistic information of the flush packets.
debug ulpp flush {send receive} interface <name> no debug ulpp flush {send receive} interface <name>	Show the information of the receiving and sending flush packets, the no operation disables the shown information.
debug ulpp flush content interface <name> no debug ulpp flush content interface <name>	Show the contents of the received flush packets, the no operation disables the showing.
debug ulpp error no debug ulpp error	Show the error information of ULPP, the no operation disables the showing.
debug ulpp event no debug ulpp event	Show the event information of ULPP, the no operation disables the showing.

61.3 ULPP Typical Examples

61.3.1 ULPP Typical Example1

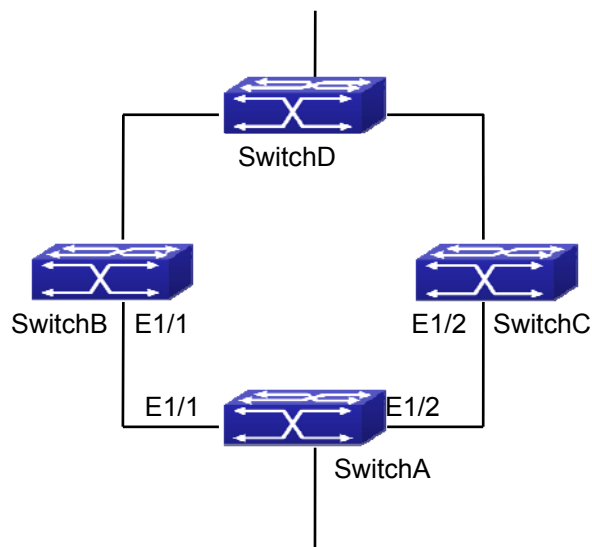

Figure 61-3-1 ULPP typical example1

The above topology is the typical application environment of ULPP protocol.

SwitchA has two uplinks, they are SwitchB and SwitchC. When any protocols are not enabled, this topology forms a ring. For avoiding the loopback, SwitchA can configure ULPP protocol, the master port and the slave port of ULPP group. When both master port and slave port are up, the slave port will be set as standby state and will not forward the data packets. When the master port is down, the slave port will be set as forwarding state and switch to the uplink. SwitchB and SwitchC can enable the command that receives the flush packets, it is used to associate with ULPP protocol running of SwitchA to switch the uplink immediately and reduce the switch delay.

When configuring ULPP protocol of SwitchA, first, create a ULPP group and configure the protection VLAN of this group as vlan10, then configure interface Ethernet 1/1 as the master port, interface Ethernet 1/2 as the slave port, the control VLAN as 5. SwitchB and SwitchC configure the flush packets that receive ULPP.

SwitchA configuration task list:

```
XGS3-42000R(config)#vlan 10
XGS3-42000R(config-vlan10)#switchport interface ethernet 1/1; 1/2
XGS3-42000R(config-vlan10)#exit
XGS3-42000R(config)#spanning-tree mst configuration
XGS3-42000R(config-Mstp-Region)#instance 1 vlan 10
XGS3-42000R(config-Mstp-Region)#exit
XGS3-42000R(config)#ulpp group 1
XGS3-42000R(ulpp-group-1)#protect vlan-reference-instance 1
XGS3-42000R(ulpp-group-1)#control vlan 5
XGS3-42000R(ulpp-group-1)#exit
XGS3-42000R(config)#interface ethernet 1/1
XGS3-42000R(config-If-Ethernet1/1)# ulpp group 1 master
XGS3-42000R(config-If-Ethernet1/1)#exit
XGS3-42000R(config)#interface Ethernet 1/2
XGS3-42000R(config-If-Ethernet1/2)# ulpp group 1 slave
XGS3-42000R(config-If-Ethernet1/2)#exit
```

SwitchB configuration task list:

```
XGS3-42000R(config)#vlan 10
XGS3-42000R(config-vlan10)#switchport interface ethernet 1/1
XGS3-42000R(config-vlan10)#exit
XGS3-42000R(config)#interface ethernet 1/1
XGS3-42000R(config-If-Ethernet1/1)# ulpp control vlan 5
XGS3-42000R(config-If-Ethernet1/1)# ulpp flush enable mac
XGS3-42000R(config-If-Ethernet1/1)# ulpp flush enable arp
```

SwitchC configuration task list:

```
XGS3-42000R(config)#vlan 10
XGS3-42000R(config-vlan10)#switchport interface ethernet 1/2
XGS3-42000R(config-vlan10)#exit
XGS3-42000R(config)#interface ethernet 1/2
XGS3-42000R(config-if-Ethernet1/2)# ulpp control vlan 5
XGS3-42000R(config-if-Ethernet1/2)# ulpp flush enable mac
XGS3-42000R(config-if-Ethernet1/2)# ulpp flush enable arp
```

61.3.2 ULPP Typical Example2

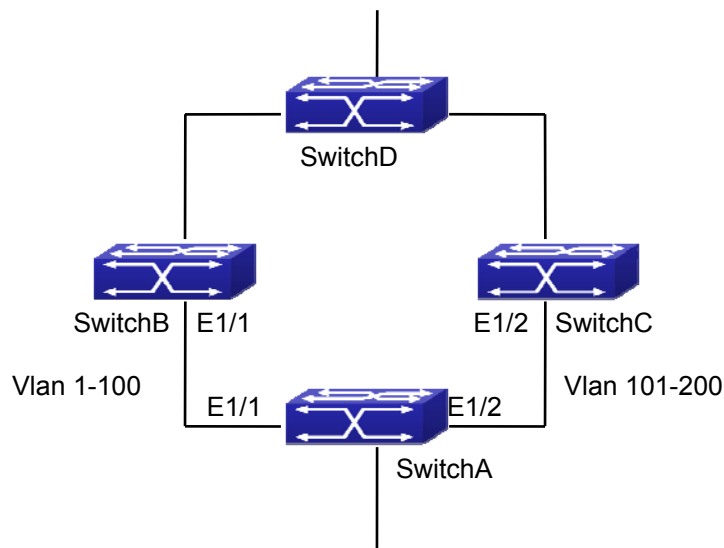

Figure 61-3-2 ULPP typical example2

ULPP can implement the VLAN-based load balance. As the picture illustrated, SwitchA configures two ULPP groups: port E1/1 is the master port and port 1/2 is the slave port in group1, port 1/2 is the master port and port 1/1 is the slave port in group2. The VLANs protected by group1 are 1-100 and by group2 are 101-200. Here both port E1/1 and port E1/2 at the forwarding state, the master port and the slave port mutually backup, respectively forward the packets of different VLAN ranges. When port E1/1 has the problem, the traffic of VLAN 1-200 are forwarded by port E1/2. When port E1/1 is recovering the normal state, still port E1/2 forwards the data of VLAN 101-200, the data of VLAN 1-100 are switched to port E1/1 to forward.

SwitchA configuration task list:

```
XGS3-42000R(config)#spanning-tree mst configuration
XGS3-42000R(config-Mstp-Region)#instance 1 vlan 1-100
XGS3-42000R(config-Mstp-Region)#instance 2 vlan 101-200
XGS3-42000R(config-Mstp-Region)#exit
XGS3-42000R(config)#ulpp group 1
XGS3-42000R(ulpp-group-1)#protect vlan-reference-instance 1
```

```
XGS3-42000R(ulpp-group-1)#exit
XGS3-42000R(config)#ulpp group 2
XGS3-42000R(ulpp-group-2)#protect vlan-reference-instance 2
XGS3-42000R(ulpp-group-2)#exit
XGS3-42000R(config)#interface ethernet 1/1
XGS3-42000R(config-If-Ethernet1/1)#switchport mode trunk
XGS3-42000R(config-If-Ethernet1/1)#ulpp group 1 master
XGS3-42000R(config-If-Ethernet1/1)#ulpp group 2 slave
XGS3-42000R(config-If-Ethernet1/1)#exit
XGS3-42000R(config)#interface Ethernet 1/2
XGS3-42000R(config-If-Ethernet1/2)#switchport mode trunk
XGS3-42000R(config-If-Ethernet1/2)# ulpp group 1 slave
XGS3-42000R(config-If-Ethernet1/2)# ulpp group 2 master
XGS3-42000R(config-If-Ethernet1/2)#exit
```

SwitchB configuration task list:

```
XGS3-42000R(config)#interface ethernet 1/1
XGS3-42000R(config-If-Ethernet1/1)#switchport mode trunk
XGS3-42000R(config-If-Ethernet1/1)# ulpp flush enable mac
XGS3-42000R(config-If-Ethernet1/1)# ulpp flush enable arp
```

SwitchC configuration task list:

```
XGS3-42000R(config)#interface ethernet 1/2
XGS3-42000R(config-If-Ethernet1/2)# switchport mode trunk
XGS3-42000R(config-If-Ethernet1/2)# ulpp flush enable mac
XGS3-42000R(config-If-Ethernet1/2)# ulpp flush enable arp
```

61.4 ULPP Troubleshooting

- At present, configuration of more than 2 multi-uplinks is allowed, but it may cause loopback, so is not recommended.
- With the normal configuration, if the broadcast storm happen or the communication along the ring is broken, please enable the debug of ULPP, copy the debug information of 3 minutes and the configuration information, send them to our technical service center.

Chapter 62 ULSM Configuration

62.1 Introduction to ULSM

ULSM (Uplink State Monitor) is used to process the port state synchronization. Each ULSM group is made up of the uplink port and the downlink port, both the uplink port and the downlink port may be multiple. The port may be a physical port or a port channel, but it can not be a member port of a port channel, and each port only belongs to one ULSM group.

The uplink port is the monitored port of ULSM group. When all uplink ports are down or there is no uplink port in ULSM group, ULSM group state is down. ULSM group state is up as long as one uplink port is up.

The downlink port is the controlled port, its state changes along with Up/Down of ULSM group and is always the same with ULSM group state.

ULSM associates with ULPP to enable the downstream device to apperceive the link problem of the upstream device and process correctly. As the picture illustrated, SwitchA configures ULPP, here the traffic is forwarded by port A1. If the link between SwitchB and Switch D has the problem, SwitchA can not apperceive the problem of the upstream link and sequentially forward the traffic from port A1, cause traffic losing.

Configuring ULSM on SwitchB can solve the above problems. The steps are: set port B5 as the uplink port of ULSM group, port B6 as the downlink port. When the link between SwitchB and SwitchD has the problem, both the downlink port B6 and the state of ULSM group are down. It causes Switch A on which ULPP is configured to process uplink switchover and avoid the data dropped.

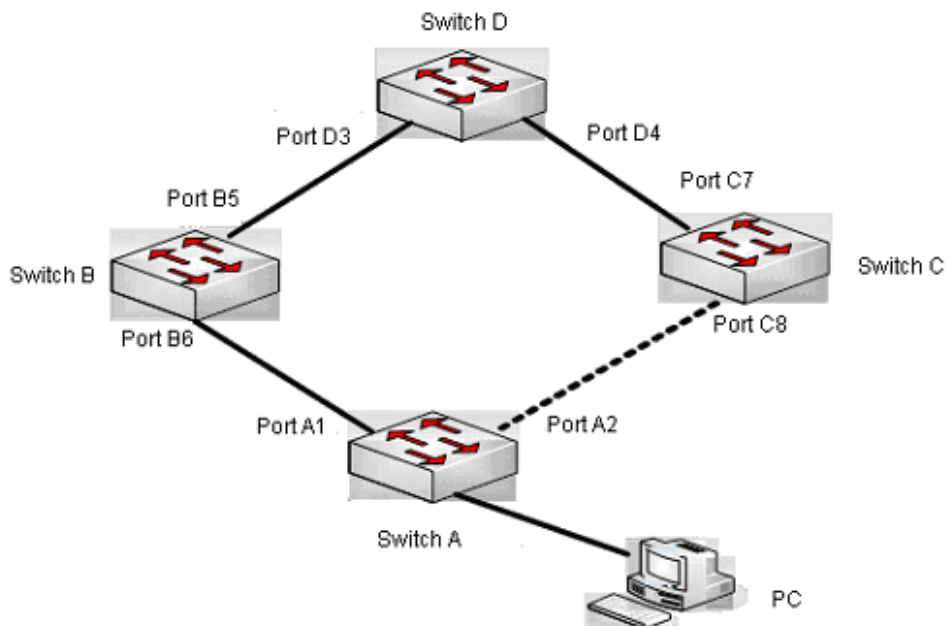

Figure 62-1-1 ULSM using scene

62.2 ULSM Configuration Task List

1. Create ULSM group globally
2. Configure ULSM group
3. Show and debug the relating information of ULSM

1. Create ULSM group globally

Command	explanation
Global mode	
ulsm group <group-id> no ulsm group <group-id>	Configure and delete ULSM group globally.

2. Configure ULSM group

Command	explanation
Port mode	
ulsm group <group-id> {uplink downlink} no ulsm group <group-id> {uplink downlink}	Configure the uplink/downlink port of ULSM group, the no command deletes the uplink/downlink port.

3. Show and debug the relating information of ULSM

Command	Explanation
Admin mode	
show ulsm group [group-id]	Show the configuration information of ULSM group.
debug ulsm event no debug ulsm event	Show the event information of ULSM, the no operation disables the shown information.

62.3 ULSM Typical Example

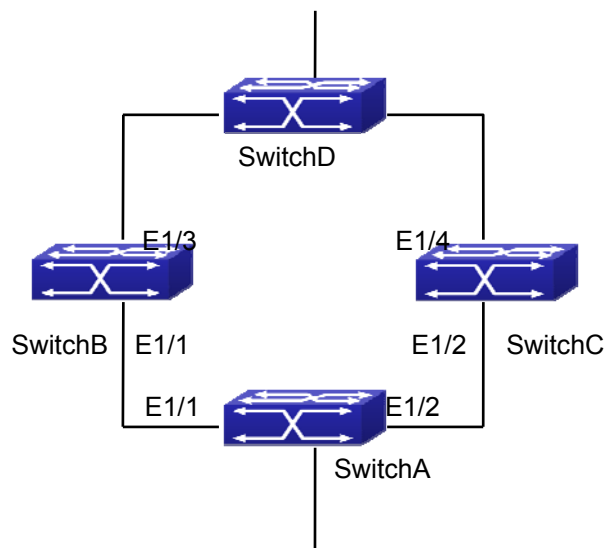

Figure 62-3-1 ULSM typical example

The above topology is the typical application environment which is used by ULSM and ULPP protocol.

ULSM is used to process the port state synchronization, its independent running is useless, and so it usually associates with ULPP protocol to use. In the topology, SwitchA enables ULPP protocol, it is used to switch the uplink. SwitchB and SwitchC enable ULSM protocol to monitor whether the uplink is down. If it is down, then ULSM will execute the down operation for the downlink port to shutdown it, so ULPP protocol of Switch A executes the relative operation of the uplink switchover.

SwitchA configuration task list:

```
XGS3-42000R(config)#spanning-tree mst configuration
XGS3-42000R(config-Mstp-Region)#instance 1 vlan 1
XGS3-42000R(config-Mstp-Region)#exit
XGS3-42000R(config)#ulpp group 1
XGS3-42000R(ulpp-group-1)#protect vlan-reference-instance 1
XGS3-42000R(ulpp-group-1)#exit
XGS3-42000R(config)#interface ethernet 1/1
XGS3-42000R(config-If-Ethernet1/1)# ulpp group 1 master
XGS3-42000R(config-If-Ethernet1/1)#exit
XGS3-42000R(config)#interface Ethernet 1/2
XGS3-42000R(config-If-Ethernet1/2)# ulpp group 1 slave
XGS3-42000R(config-If-Ethernet1/2)#exit
```

SwitchB configuration task list:

```
XGS3-42000R(config)#ulsm group 1
XGS3-42000R(config)#interface ethernet 1/1
XGS3-42000R(config-If-Ethernet1/1)#ulsm group 1 downlink
XGS3-42000R(config-If-Ethernet1/1)#exit
XGS3-42000R(config)#interface ethernet 1/3
XGS3-42000R(config-If-Ethernet1/3)#ulsm group 1 uplink
XGS3-42000R(config-If-Ethernet1/3)#exit
```

SwitchC configuration task list:

```
XGS3-42000R(config)#ulsm group 1
XGS3-42000R(config)#interface ethernet 1/2
XGS3-42000R(config-If-Ethernet1/2)#ulsm group 1 downlink
XGS3-42000R(config-If-Ethernet1/2)#exit
XGS3-42000R(config)#interface ethernet 1/4
XGS3-42000R(config-If-Ethernet1/4)#ulsm group 1 uplink
XGS3-42000R(config-If-Ethernet1/4)#exit
```

62.4 ULSM Troubleshooting

- With the normal configuration, if the downlink port does not respond to the down event of the uplink port, please enable the debug function of ULSM, copy the debug information of 3 minutes and the configuration information, and send them to our technical service center.

Chapter 63 SNTP Configuration

63.1 Introduction to SNTP

The Network Time Protocol (NTP) is widely used for clock synchronization for global computers connected to the Internet. NTP can assess packet sending/receiving delay in the network, and estimate the computer's clock deviation independently, so as to achieve high accuracy in network computer clocking. In most positions, NTP can provide accuracy from 1 to 50ms according to the characteristics of the synchronization source and network route.

Simple Network Time Protocol (SNTP) is the simplified version of NTP, removing the complex algorithm of NTP. SNTP is used for hosts who do not require full NTP functions; it is a subset of NTP. It is common practice to synchronize the clocks of several hosts in local area network with other NTP hosts through the Internet, and use those hosts to provide time synchronization service for other clients in LAN. The figure below depicts a NTP/SNTP application network topology, where SNTP mainly works between second level servers and various terminals since such scenarios do not require very high time accuracy, and the accuracy of SNTP (1 to 50 ms) is usually sufficient for those services.

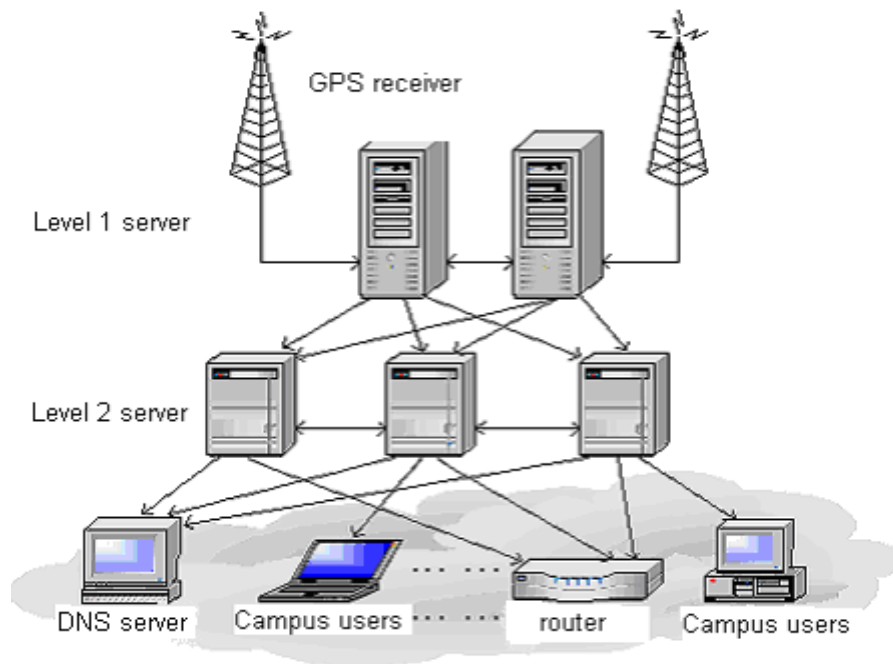

Figure 63-1-1 Working Scenario

Switch implements SNTPv4 and supports SNTP client unicast as described in RFC2030; SNTP client multicast and unicast are not supported, nor is the SNTP server function.

63.2 Typical Examples of SNTP Configuration

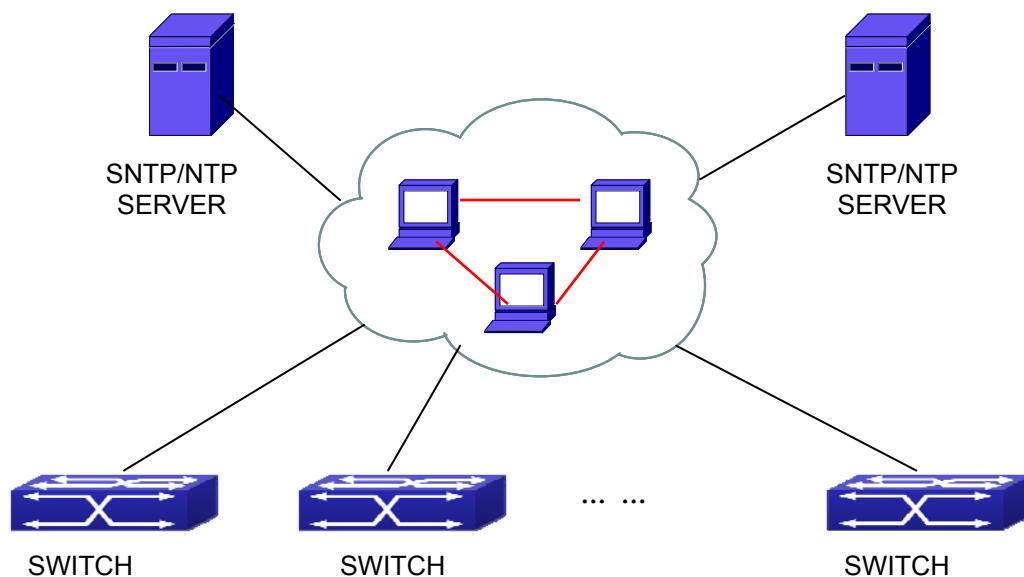

Figure 63-2-1 Typical SNTP Configuration

All switches in the autonomous zone are required to perform time synchronization, which is done through two redundant SNTP/NTP servers. For time to be synchronized, the network must be properly configured. There should be reachable route between any switch and the two SNTP/NTP servers.

Example: Assume the IP addresses of the SNTP/NTP servers are 10.1.1.1 and 20.1.1.1, respectively, and SNTP/NTP server function (such as NTP master) is enabled, then configurations for any switch should like the following:

```
XGS3-42000R#config
XGS3-42000R(config)#sntp server 10.1.1.1
```

Chapter 64 NTP Function Configuration

64.1 Introduction to NTP Function

The NTP (Network Time Protocol) synchronizes timekeeping spans WAN and LAN among distributed time servers and clients, it can get millisecond precision. The introduction of event, state, transmit function and action are defined in RFC-1305.

The purpose of using NTP is to keep consistent timekeeping among all clock-dependent devices within the network so that the devices can provide diverse applications based on the consistent time.

For a local system running NTP, its time can be synchronized by other reference sources and can be used as a reference source to synchronize other clocks, also can synchronize each other by transmit NTP packets.

64.2 NTP Function Configuration Task List

1. To enable NTP function
2. To configure NTP server function
3. To configure the max number of broadcast or multicast servers supported by the NTP client
4. To configure time zone
5. To configure NTP access control list
6. To configure NTP authentication
7. To specified some interface as NTP broadcast/multicast client interface
8. To configure some interface can't receive NTP packets
9. Display information
10. Debug

1. To enable NTP function

Command	Explication
Global Mode	
ntp enable ntp disable	To enable or disable NTP function.

2. To configure NTP server function

Command	Explication
Global Mode	
<pre>ntp server {<ip-address> / <ipv6-address>} [version <version_no>] [key <key-id>] no ntp server {<ip-address> / <ipv6-address>}</pre>	To enable the specified time server of time source.

3. To configure the max number of broadcast or multicast servers supported by the NTP client

Command	Explication
Global Mode	
<pre>ntp broadcast server count <number> no ntp broadcast server count</pre>	Set the max number of broadcast or multicast servers supported by the NTP client. The no operation will cancel the configuration and restore the default value.

4. To configure time zone

Command	Explication
Global Mode	
<pre>ntp timezone <name> [{add subtract}] [<time_difference>] no ntp timezone</pre>	To configure the time zone and time different with UTC for NTP client.

5. To configure NTP access control list

Command	Explication
Global Mode	
<pre>ntp access-group server <acl> no ntp access-group server <acl></pre>	To configure NTP server access control list.

6. To configure NTP authentication

Command	Explication
Global Mode	
<pre>ntp authenticate no ntp authenticate</pre>	To enable NTP authentication function.
<pre>ntp authentication-key <key-id> md5 <value> no ntp authentication-key <key-id></pre>	To configure authentication key for NTP authentication.
<pre>ntp trusted-key <key-id> no ntp trusted-key <key-id></pre>	To configure trusted key.

7. To specified some interface as NTP broadcast/multicast client interface

Command	Explication
Interface Configuration Mode	
ntp broadcast client no ntp broadcast client	To configure specified interface to receive NTP broadcast packets.
ntp multicast client no ntp multicast client	To configure specified interface to receive NTP multicast packets.
ntp ipv6 multicast client no ntp ipv6 multicast client	To configure specified interface to receive IPv6 NTP multicast packets.

8. To configure some interface can't receive NTP packets

Command	Explication
Interface Configuration Mode	
ntp disable no ntp disable	To disable the NTP function.

9. Display information

Command	Explication
Admin Mode	
show ntp status	To display the state of time synchronize.
show ntp session [<ip-address> <ipv6-address>]	To display the information of NTP session.

10. Debug

Command	Explication
Admin Mode	
debug ntp authentication no debug ntp authentication	To enable debug switch of NTP authentication.
debug ntp packets [send receive] no debug ntp packets [send receive]	To enable debug switch of NTP packet information.
debug ntp adjust no debug ntp adjust	To enable debug switch of time update information.
debug ntp sync no debug ntp sync	To enable debug switch of time synchronize information.
debug ntp events no debug ntp events	To enable debug switch of NTP event information.

64.3 Typical Examples of NTP Function

A client switch wanted to synchronize time with time server in network, there is two time server in network, the one is used as host, the other is used as standby, the connection and configuration as follows (Switch A and Switch B are the switch or route which support NTP server):

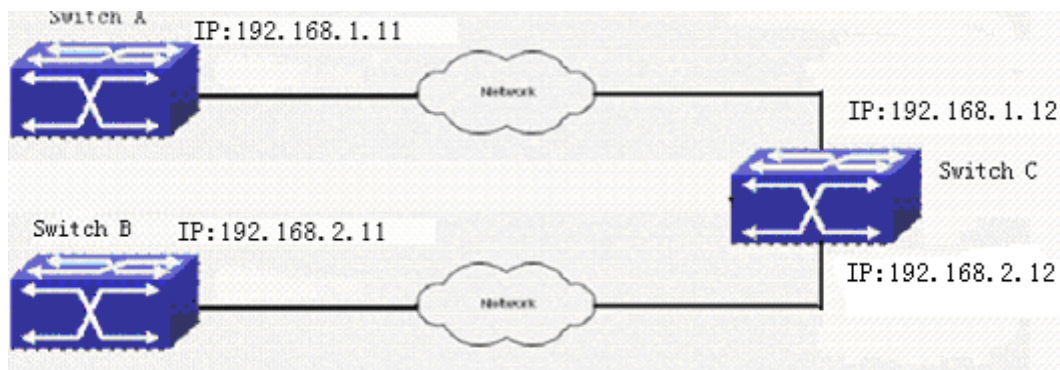

The configuration of Switch C is as follows: (Switch A and Switch B may have the different command because of different companies, we not explain there, our switches are not support NTP server at present)

Switch C:

```
XGS3-42000R(config)#ntp enable
XGS3-42000R(config)#interface vlan 1
XGS3-42000R(config-if-Vlan1)#ip address 192.168.1.12 255.255.255.0
XGS3-42000R(config)#interface vlan 2
XGS3-42000R(config-if-Vlan1)#ip address 192.168.2.12 255.255.255.0
XGS3-42000R(config)#ntp server 192.168.1.11
XGS3-42000R(config)#ntp server 192.168.2.11
```

64.4 NTP Function Troubleshooting

In configuration procedures, if there is error occurred, the system can give out the debug information.

The NTP function disables by default, the show command can be used to display current configuration. If the configuration is right please use debug every relative debugging command and display specific information in procedure, and the function is configured right or not, you can also use show command to display the NTP running information, any questions please send the recorded message to the technical service center.

Chapter 65 DNSv4/v6 Configuration

65.1 Introduction to DNS

DNS (Domain Name System) is a distributed database used by TCP/IP applications to translate domain names into corresponding IPv4/IPv6 addresses. With DNS, you can use easy-to-remember and signification domain names in some applications and let the DNS server translate them into correct IPv4/IPv6 addresses.

There are two types of DNS services, static and dynamic, which supplement each other in application. Each time the DNS server receives a name query it checks its static DNS database first before looking up the dynamic DNS database. Some frequently used addresses can be put in the static DNS database, the reduction the searching time in the dynamic DNS database would increase efficiency. The static domain name resolution means setting up mappings between domain names and IPv4/IPv6 addresses. IPv4/IPv6 addresses of the corresponding domain names can be found in the static DNS database when you use some applications. Dynamic domain name resolution is implemented by querying the DNS server. A user program sends a name query to the resolver in the DNS client when users want to use some applications with domain name, the DNS resolver looks up the local domain name cache for a match. If a match is found, it sends the corresponding IPv4/IPv6 address back to the switch. If no match is found, it sends a query to a higher DNS server. This process continues until a result, whether success or failure, is returned.

The Domain Name System (DNS) is a hierarchical naming system for computers, services, or any resource participating in the Internet. It associates various information with domain names assigned to such participants. Most importantly, it translates humanly meaningful domain names to the numerical (binary) identifiers associated with networking equipment for the purpose of locating and addressing these devices world-wide. An often used analogy to explain the Domain Name System is that it serves as the "phone book" for the Internet by translating human-friendly computer hostnames into IP addresses.

The Domain Name System makes it possible to assign domain names to groups of Internet users in a meaningful way, independent of each user's physical location. Because of this, World-Wide Web (WWW) hyperlinks and Internet contact information can remain consistent and constant even if the current Internet routing arrangements change or the participant uses a mobile device. Internet domain names are easier to remember than IP addresses such as 208.77.188.166(IPv4) or 2001:db8:1f70::999:de8:7648:6e8 (IPv6). People take advantage of this when they recite meaningful URLs and e-mail addresses without having to know how the machine will actually locate them.

The Domain Name System distributes the responsibility for assigning domain names and mapping them to Internet Protocol (IP) networks by designating authoritative name servers for each domain to keep track of their own changes, avoiding the need for a central register to be continually consulted and updated.

In general, the Domain Name System also stores other types of information, such as the list of mail servers that accept email for a given Internet domain. By providing a world-wide, distributed keyword-based redirection service, the Domain Name System is an essential component of the functionality of the Internet.

65.2 DNSv4/v6 Configuration Task List

1. To enable/disable DNS function
2. To configure/delete DNS server
3. To configure/delete domain name suffix
4. To delete the domain entry of specified address in dynamic cache
5. To enable DNS dynamic domain name resolution
6. Enable/disable DNS SERVER function
7. Configure the max number of client information in the switch queue
8. Configure the timeout value of caching the client information on the switch
9. Monitor and diagnosis of DNS function

1. To enable/disable DNS function

Command	Explanation
Global Mode	
ip domain-lookup no ip domain-lookup	To enable/disable DNS dynamic lookup function.

2. To configure/delete DNS server

Command	Explanation
Global Mode	
dns-server {<ip-address> / <ipv6-address>} [priority <value>] no dns-server {<ip-address> / <ipv6-address>}	To configure DNS server, the no form of this command deletes DNS server.

3. To configure/delete domain name suffix

Command	Explanation
Global Mode	
ip domain-list <WORD> no ip domain-list <WORD>	To configure/delete domain name suffix.

4. To delete the domain entry of specified address in dynamic cache

Command	Explanation
Admin Mode	
clear dynamic-host {<ip-address> / <ipv6-address>} / all}	To delete the domain entry of specified address in dynamic cache.

5. To enable DNS dynamic domain name resolution

Command	Explanation
Global Mode	
dns lookup {ipv4 ipv6} <hostname>	To enable DNS dynamic domain name resolution.

6. Enable/disable DNS SERVER function

Command	Explanation
Global Mode	
ip dns server no ip dns server	Enable/disable DNS SERVER function.

7. Configure the max number of client information in the switch queue

Command	Explanation
Global Mode	
ip dns server queue maximum <1-5000> no ip dns server queue maximum	Configure the max number of client information in the switch queue.

8. Configure the timeout value of caching the client information on the switch

Command	Explanation
Global Mode	
ip dns server queue timeout <1-100> no ip dns server queue timeout	Configure the timeout value of caching the client information on the switch.

9. Monitor and diagnosis of DNS function

Command	Explanation
Admin Mode and Configuration Mode	
show dns name-server	To show the configured DNS server information.
show dns domain-list	To show the configured DNS domain name suffix information.
show dns hosts	To show the dynamic domain name information of resolved by switch.
show dns config	Display the configured global DNS information on the switch.
show dns client	Display the DNS Client information maintained by the switch.
debug dns {all packet [send rcv] events relay} no debug dns {all packet [send rcv] events relay}	To enable/disable DEBUG of DNS function.

65.3 Typical Examples of DNS

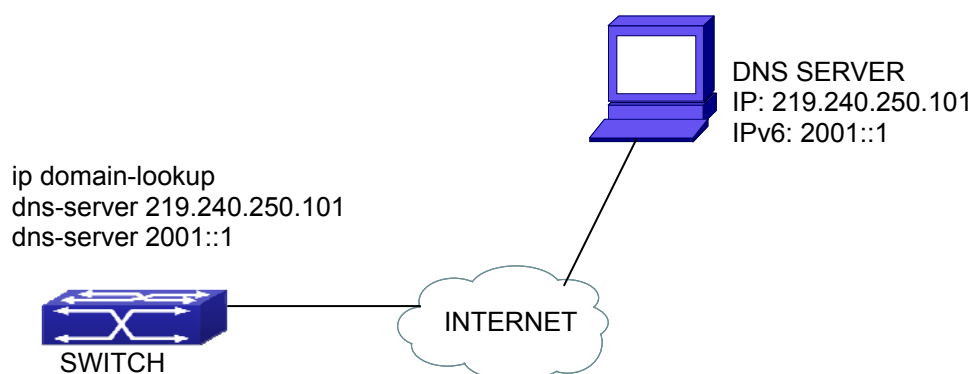

Figure 65-3-1 DNS CLIENT typical environment

As shown in fig, the switch connected to DNS server through network, if the switch want to visit sina Website, it needn't to know the IPv4/IPv6 address of sina Website, only need is to record the domain name of sina Website is www.sina.com.cn. The DNS server can resolute out the IPv4/IPv6 address of this domain name and send to switch, then the switch can visit sina Website correctly. The switch is configured as DNS client, basic configurations are as below: first to enable DNS dynamic domain name resolution function on switch, and configure DNS server address, then with some kinds of tools such as PING, the switch can get corresponding IPv4/IPv6 address with dynamic domain name resolution function.

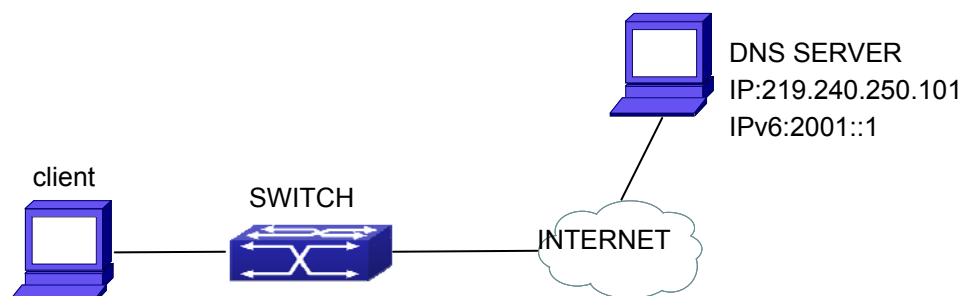

Figure 65-3-2 DNS SERVER typical environment

The figure above is an application of DNS SERVER. Under some circumstances, the client PC doesn't know the real DNS SERVER, and points to the switch instead. The switch plays the role of a DNS SERVER in two steps: Enable the global DNS SERVER function, configure the IP address of the real DNS server. After the DNS SERVER function is globally enabled, the switch will look up its local cache when receiving a DNS request from a client PC. If there is a domain needed by the local client, it will directly answer the client's request; otherwise, the switch will relay the request to the real DNS server, pass the reply from the DNS Server to the client and record the domain and its IP address for a faster lookup in the future.

Switch configuration for DNS CLIENT:

```
XGS3-42000R(config)# ip domain-lookup
XGS3-42000R(config)# dns-server 219.240.250.101
XGS3-42000R(config)# dns-server 2001::1
XGS3-42000R#ping host www.sina.com.cn
XGS3-42000R#traceroute host www.sina.com.cn
XGS3-42000R#telnet host www.sina.com.cn
```

Switch configuration for DNS SERVER:

```
XGS3-42000R(config)# ip domain-lookup
XGS3-42000R(config)# dns-server 219.240.250.101
XGS3-42000R(config)# dns-server 2001::1
XGS3-42000R(config)# ip dns server
```

65.4 DNS Troubleshooting

In configuring and using DNS, the DNS may fail due to reasons such as physical connection failure or wrong configurations. The user should ensure the following:

- First make sure good condition of the TACACS+ server physical connection;
- Second all interface and link protocols are in the UP state (use “**show interface**” command);
- Then please make sure that the DNS dynamic lookup function is enabled (use the “ip domain-lookup” command) before enabling the DNS CLIENT function. To use DNS SERVER function, please enable it (use the “ip dns server” command);
- Finally ensure configured DNS server address (use “**dns-server**” command), and the switch can ping DNS server;
- If the DNS problems remain unsolved, please use debug DNS all and other debugging command and copy the DEBUG message within 3 minutes, send the recorded message to the technical service center of our company.

Chapter 66 Monitor and Debug

When the users configures the switch, they will need to verify whether the configurations are correct and the switch is operating as expected, and in network failure, the users will also need to diagnostic the problem. Switch provides various debug commands including ping, telnet, show and debug, etc. to help the users to check system configuration, operating status and locate problem causes.

66.1 Ping

Ping command is mainly used for sending ICMP query packet from the switches to remote devices, also for check the accessibility between the switch and the remote device. Refer to the Ping command chapter in the Command Manual for explanations of various parameters and options of the Ping command.

66.2 Ping6

Ping6 command is mainly used by the switch to send ICMPv6 query packet to the remote equipment, verifying the accessibility between the switch and the remote equipment. Options and explanations of the parameters of the Ping6 command please refer to Ping6 command chapter in the command manual.

66.3 Traceroute

Traceroute command is for testing the gateways through which the data packets travel from the source device to the destination device, so to check the network accessibility and locate the network failure.

Execution procedure of the Traceroute command consists of: first a data packet with TTL at 1 is sent to the destination address, if the first hop returns an ICMP error message to inform this packet can not be sent (due to TTL timeout), a data packet with TTL at 2 will be sent. Also the send hop may be a TTL timeout return, but the procedure will carries on till the data packet is sent to its destination. These procedures is for recording every source address which returned ICMP TTL timeout message, so to describe a path the IP data packets traveled to reach the destination.

Traceroute Options and explanations of the parameters of the Traceroute command please refer to traceroute command chapter in the command manual.

66.4 Traceroute6

The Traceroute6 function is used on testing the gateways passed through by the data packets from the source equipment to the destination equipment, to verify the accessibility and locate the network failure. The principle of the Traceroute6 under IPv6 is the same as that under IPv4, which adopts the hop limit field of the ICMPv6 and IPv6 header. First, Traceroute6 sends an IPv6 datagram (including source address, destination address and packet sent time) whose HOPLIMIT is set to 1. When first route on the path receives this datagram, it minus the HOPLIMIT by 1 and the HOPLIMIT is now 0. So the router will discard this datagram and returns with a 「ICMPv6 time exceeded」 message (including the source address of the IPv6 packet, all content in the IPv6 packet and the IPv6 address of the router). Upon receiving this message, the Traceroute6 sends another datagram of which the HOPLIMIT is increased to 2 so to discover the second router. Plus 1 to the HOPLIMIT every time to discover another router, the Traceroute6 repeat this action till certain datagram reaches the destination.

Traceroute6 Options and explanations of the parameters of the Traceroute6 command please refer to traceroute6 command chapter in the command manual.

66.5 Show

show command is used to display information about the system , port and protocol operation. This part introduces the **show** command that displays system information, other **show** commands will be discussed in other chapters.

Admin Mode	
show debugging	Display the debugging state.
show flash	Display the files and the sizes saved in the flash.
show history	Display the recent user input history command.
show memory	Display content in specified memory area.
show running-config	Display the switch parameter configuration validating at current operation state.
show startup-config	Display the switch parameter configuration written in the Flash Memory at current operation state, which is normally the configuration file applied in next time the switch starts up.
show switchport interface [ethernet <IFNAME>]	Display the VLAN port mode and the belonging VLAN number of the switch as well as the Trunk port information.
show tcp	Display the TCP connection status established currently on the switch.
show udp	Display the UDP connection status established currently on the switch.

show telnet login	Display the information of the Telnet client which currently establishes a Telnet connection with the switch.
show tech-support	Display the operation information and the state of each task running on the switch. It is used by the technicians to diagnose whether the switch operates properly.
show version	Display the version of the switch.
show temperature	Show CPU temperature of the switch.

66.6 Debug

All the protocols switch supports have their corresponding debug commands. The users can use the information from debug commands for troubleshooting. Debug commands for their corresponding protocols will be introduced in the later chapters.

66.7 System log

66.7.1 System Log Introduction

The system log takes all information output under its control, while making a detailed catalogue, so to select the information effectively. Combining with Debug programs, it will provide a powerful support to the network administrator and developer in monitoring the network operation state and locating the network failures.

The switch system log has the following characteristics:

- Log output from four directions (or log channels) of the Console, Telnet terminal and monitor, log buffer zone, and log host.
- The log information is classified to four levels of severities by which the information will be filtered.
- According to the severity level the log information can be auto outputted to the corresponding log channel.

66.7.1.1 Log Output Channel

So far the system log can be outputted the log information through four channels:

- Through Console port to the local console
- Output the log information to remote Telnet terminal or monitor, this function is good for remote maintenance
- Assign a proper log buffer zone inside the switch, for record the log information permanently or temporarily
- Configure the log host, the log system will directly send the log information to the log host, and save it in files to be viewed at any time

Among above log channels, users rarely use the console monitor, but will commonly choose the Telnet terminal to monitor the system operation status. However information outputted from these channels are of low traffic capacity and can not be recorded for later view. The other two channels---the log buffer zone and log host channel are two important channels

SDRAM (Synchronous Dynamic Random Access Memory) and NVRAM (Non Volatile Random Access Memory) is provided inside the switch as two part of the log buffer zone, The two buffer zone record the log information in a circuit working pattern, namely when log information need to be recorded exceeds the buffer size, the oldest log information will be erased and replaced by the new log information, information saved in NVRAM will stay permanently while those in SDRAM will lost when the system restarts or encounter an power failure. Information in the log buffer zone is critical for monitoring the system operation and detecting abnormal states.

Note: the NVRAM log buffer may not exist on some switches, which only have the SDRAM log buffer zone.

It is recommended to use the system log server. By configuring the log host on the switch, the log can be sent to the log server for future examination.

66.7.1.2 Format and Severity of the Log Information

The log information format is compatible with the BSD syslog protocol, so we can record and analyze the log by the syslog (system log protect session) on the UNIX/LINUX, as well as syslog similar applications on PC.

The log information is classified into eight classes by severity or emergency procedure. One level per value and the higher the emergency level the log information has, the smaller its value will be. For example, the level of critical is 2, and warning is 4, debugging is leveled at 7, so the critical is higher than warnings which no doubt is high than debugging. The rule applied in filtering the log information by severity level is that: only the log information with level equal to or higher than the threshold will be outputted. So when the severity threshold is set to debugging, all information will be outputted and if set to critical, only critical, alerts and emergencies will be outputted.

Follow table summarized the log information severity level and brief description. **Note:** these severity levels are in accordance with the standard UNIX/LINUX syslog.

Table 1-1 Severity of the log information

Severity	Value	Description
emergencies	0	System is unusable
alerts	1	Action must be taken immediately
critical	2	Critical conditions
errors	3	Error conditions
warnings	4	Warning conditions
notifications	5	Normal but significant condition

informational	6	Informational messages
debugging	7	Debug-level messages

Right now the switch can generate information of following four levels

- Restart the switch, mission abnormal, hot plug on the Chassis Switch chips are classified critical
- Up/down interface, topology change, aggregate port state change of the interface are notifications warnings
- Outputted information from the CLI command is classified informational
- Information from the debugging of CLI command is classified debugging

Log information can be automatically sent to corresponding channels with regard to respective severity levels. Amongst the debugging information can only be sent to the monitor. Those with the Informational level can only be sent to current monitor terminal, such as the information from the Telnet terminal configuration command can only be transmitted to the Telnet terminal. Warnings information can be sent to all terminal with also saved in the SDRAM log buffer zone. And the critical information can be save both in SDRAM and the NVRAM (if exists) besides sent to all terminals. To check the log save in SDRAM and the NVRAM, we can use the show logging buffered command. To clear the log save in NVRAM and SDRAM log buffer zone, we can use the clear logging command.

66.7.2 System Log Configuration

System Log Configuration Task Sequence:

1. Display and clear log buffer zone
2. Configure the log host output channel

1. Display and clear log buffer zone

Command	Description
Admin Mode	
show logging buffered [level {critical warnings} range <begin-index> <end-index>]	Show detailed log information in the log buffer channel.
clear logging {sdram nvram}	Clear log buffer zone information.

2. Configure the log host output channel

Command	Description
Global Mode	
logging {<ipv4-addr> <ipv6-addr>} [facility <local-number>] [level <severity>] no logging {<ipv4-addr> <ipv6-addr>} [facility <local-number>]	Enable the output channel of the log host. The “no” form of this command will disable the output at the output channel of the log host.

66.7.3 System Log Configuration Example

Example 1: When managing VLAN the IPv4 address of the switch is 100.100.100.1, and the IPv4 address of the remote log server is 100.100.100.5. It is required to send the log information with a severity equal to or higher than warnings to this log server and save in the log record equipment local1.

Configuration procedure:

```
XGS3-42000R(config)#interface vlan 1
XGS3-42000R(config-if-Vlan1)# ip address 100.100.100.1 255.255.255.0
XGS3-42000R(config-if-Vlan1)#exit
XGS3-42000R(config)#logging 100.100.100.5 facility local1 level warnings
```

Example 2: When managing VLAN the IPv6 address of the switch is 3ffe:506::1, and the IPv4 address of the remote log server is 3ffe:506::4. It is required to send the log information with a severity equal to or higher than critical to this log server and save the log in the record equipment local7.

Configuration procedure

```
XGS3-42000R(config)#interface vlan 1
XGS3-42000R(config-if-Vlan1)#ipv6 address 3ffe:506::1/64
XGS3-42000R(config-if-Vlan1)#exit
XGS3-42000R(config)#logging 3ffe:506::4 facility local7 level critical
```

Chapter 67 Reload Switch after Specified Time

67.1 Introduce to Reload Switch after Specified Time

Reload switch after specified time is to reboot the switch without shutdown its power after a specified period of time, usually when updating the switch version. The switch can be rebooted after a period of time instead of immediately after its version being updated successfully.

67.2 Reload Switch after Specified Time Task List

1. Reload switch after specified time

Command	Explanation
Admin mode	
reload after <HH:MM:SS>	Reload the switch after a specified period of time.
reload cancel	Cancel the specified time period to reload the switch.

Chapter 68 Debugging and Diagnosis for Packets Received and Sent by CPU

68.1 Introduction to Debugging and Diagnosis for Packets Received and Sent by CPU

The following commands are used to debug and diagnose the packets received and sent by CPU, and are supposed to be used with the help of the technical support.

68.2 Debugging and Diagnosis for Packets Received and Sent by CPU Task List

Command	Explanation
Global Mode	
cpu-rx-ratelimit total <packets> no cpu-rx-ratelimit total	Set the total rate of the CPU receiving packets, the no command sets the total rate of the CPU receiving packets to default.
cpu-rx-ratelimit queue-length <queue-id> <qlen-value> no cpu-rx-ratelimit queue-length [<queue-id>]	Set the length of the specified queue, the no command set the length to default.
cpu-rx-ratelimit protocol <protocol-type> <packets> no cpu-rx-ratelimit protocol [<protocol-type>]	Set the max rate of the CPU receiving packets of the protocol type, the “ no cpu-rx-ratelimit protocol <protocol-type> ” command set the max rate to default.
clear cpu-rx-stat protocol [<protocol-type>]	Clear the statistics of the CPU received packets of the protocol type.
cpu-rx-ratelimit channel <channel-id> <packets> no cpu-rx-ratelimit channel [<channel-id>]	This command is not supported by switch.
Admin Mode	
show cpu-rx protocol [<protocol-type>]	Show the information of the CPU received packets of the protocol type.
debug driver {receive send} [interface {<interface-name> all}] [protocol {<protocol-type> discard all}][detail]	Turn on the showing of the CPU receiving or sending packet informations.
no debug driver {receive send}	Turn off the showing of the CPU receiving or sending packet informations.

Chapter 69 SWITCH OPERATION

69.1 Address Table

The Switch is implemented with an address table. This address table composed of many entries. Each entry is used to store the address information of some node in network, including MAC address, port no, etc. This information comes from the learning process of Ethernet Switch.

69.2 Learning

When one packet comes in from any port, the Switch will record the source address, port no. And the other related information in address table. This information will be used to decide either forwarding or filtering for future packets.

69.3 Forwarding & Filtering

When one packet comes from some port of the Ethernet Switching, it will also check the destination address besides the source address learning. The Ethernet Switching will lookup the address-table for the destination address. If not found, this packet will be forwarded to all the other ports except the port, which this packet comes in. And these ports will transmit this packet to the network it connected. If found, and the destination address is located at different port from this packet comes in, the Ethernet Switching will forward this packet to the port where this destination address is located according to the information from address table. But, if the destination address is located at the same port with this packet comes in, then this packet will be filtered. Thereby increasing the network throughput and availability

69.4 Store-and-Forward

Store-and-Forward is one type of packet-forwarding techniques. A Store-and-Forward Ethernet Switching stores the incoming frame in an internal buffer, do the complete error checking before transmission. Therefore, no error packets occurrence, it is the best choice when a network needs efficiency and stability.

The Ethernet Switch scans the destination address from the packet-header, searches the routing table provided for the incoming port and forwards the packet, only if required. The fast forwarding makes the switch attractive for connecting servers directly to the network, thereby increasing throughput and availability. However, the switch is most commonly used to segment existence hubs, which nearly always improves overall performance. An Ethernet Switching can be easily configured in any Ethernet network environment to significantly boost bandwidth using conventional cabling and adapters.

Due to the learning function of the Ethernet switching, the source address and corresponding port number of each incoming and outgoing packet are stored in a routing table. This information is subsequently used to filter packets whose destination address is on the same segment as the source address. This confines network traffic to its respective domain and reduce the overall load on the network.

The Switch performs "Store and forward" therefore, no error packets occur. More reliably, it reduces the re-transmission rate. No packet loss will occur.

69.5 Auto-Negotiation

The STP ports on the Switch have built-in "Auto-negotiation". This technology automatically sets the best possible bandwidth when a connection is established with another network device (usually at Power On or Reset). This is done by detect the modes and speeds at the second of both device is connected and capable of, both 10BASE-T, 100BASE-TX and 1000BASE-T devices can connect with the port in either Half- or Full-Duplex mode.

If attached device is:	100BASE-TX port will set to:
10Mbps, no auto-negotiation	10Mbps.
10Mbps, with auto-negotiation	10/20Mbps (10BASE-T/Full-Duplex)
100Mbps, no auto-negotiation	100Mbps
100Mbps, with auto-negotiation	100/200Mbps (100BASE-TX/Full-Duplex)
1000Mbps, no auto-negotiation	1000Mbps
1000Mbps, with auto-negotiation	1000/2000Mbps (1000BASE-T/Full-Duplex)

Chapter 70 TROUBLE SHOOTING

This chapter contains information to help you solve problems. If the Ethernet Switch is not functioning properly, make sure the Ethernet Switch was set up according to instructions in this manual.

The Link LED is not lit

Solution:

Check the cable connection and remove duplex mode of the Ethernet Switch

Some stations cannot talk to other stations located on the other port

Solution:

Please check the VLAN settings, trunk settings, or port enabled / disabled status.

Performance is bad

Solution:

Check the full duplex status of the Ethernet Switch. If the Ethernet Switch is set to full duplex and the partner is set to half duplex, then the performance will be poor. Please also check the in/out rate of the port.

Why the Switch doesn't connect to the network

Solution:

- Check the LNK/ACT LED on the switch
- Try another port on the Switch
- Make sure the cable is installed properly
- Make sure the cable is the right type
- Turn off the power. After a while, turn on power again

Chapter 71 APPENDEX A

71.1 A.1 Switch's RJ-45 Pin Assignments

1000Mbps, 1000BASE-T

Contact	MDI	MDI-X
1	BI_DA+	BI_DB+
2	BI_DA-	BI_DB-
3	BI_DB+	BI_DA+
4	BI_DC+	BI_DD+
5	BI_DC-	BI_DD-
6	BI_DB-	BI_DA-
7	BI_DD+	BI_DC+
8	BI_DD-	BI_DC-

Implicit implementation of the crossover function within a twisted-pair cable, or at a wiring panel, while not expressly forbidden, is beyond the scope of this standard.

71.2 A.2 10/100Mbps, 10/100BASE-TX

When connecting your 10/100Mbps Ethernet Switch to another switch, a bridge or a hub, a straight or crossover cable is necessary. Each port of the Switch supports auto-MDI/MDI-X detection. That means you can directly connect the Switch to any Ethernet devices without making a crossover cable. The following table and diagram show the standard RJ-45 receptacle/ connector and their pin assignments:

RJ-45 Connector pin assignment		
Contact	MDI Media Dependant Interface	MDI-X Media Dependant Interface-Cross
1	Tx + (transmit)	Rx + (receive)
2	Tx - (transmit)	Rx - (receive)
3	Rx + (receive)	Tx + (transmit)
4, 5	Not used	
6	Rx - (receive)	Tx - (transmit)
7, 8	Not used	

The standard cable, RJ-45 pin assignment

Chapter 72 GLOSSARY

Bandwidth Utilization

The percentage of packets received over time as compared to overall bandwidth.

BOOTP

Boot protocol used to load the operating system for devices connected to the network.

Distance Vector Multicast Routing Protocol (DVMRP)

A distance-vector-style routing protocol used for routing multicast datagrams through the Internet. DVMRP combines many of the features of RIP with Reverse Path Broadcasting (RPB).

GARP VLAN Registration Protocol (GVRP)

Defines a way for switches to exchange VLAN information in order to register necessary VLAN members on ports along the Spanning Tree so that VLANs defined in each switch can work automatically over a Spanning Tree network.

Generic Attribute Registration Protocol (GARP)

GARP is a protocol that can be used by endstations and switches to register and propagate multicast group membership information in a switched environment such that multicast data frames are propagated only to those parts of a switched LAN containing registered endstations. Formerly called Group Address Registration Protocol.

Group Attribute Registration Protocol

See Generic Attribute Registration Protocol.

Generic Multicast Registration Protocol (GMRP)

GMRP allows network devices to register end-stations with multicast groups. GMRP requires that any participating network devices or end-stations comply with the IEEE 802.1p standard.

ICMP Router Discovery

ICMP Router Discovery message is an alternative router discovery method that uses a pair of ICMP messages on multicast links. It eliminates the need to manually configure router addresses and is independent of any specific routing protocol.

Internet Control Message Protocol (ICMP)

Commonly used to send echo messages (i.e., Ping) for monitoring purposes.

IEEE 802.1D

Specifies a general method for the operation of MAC bridges, including the Spanning Tree Protocol.

IEEE 802.1Q

VLAN Tagging—Defines Ethernet frame tags which carry VLAN information. It allows switches to assign end-stations to different virtual LANs, and defines a standard way for VLANs to communicate across switched networks.

IEEE 802.3ac

Defines frame extensions for VLAN tagging.

Internet Group Management Protocol (IGMP)

A protocol through which hosts can register with their local router for multicast services. If there is more than one multicast router on a given subnetwork, one of the routers is elected “querier” and assumes the responsibility of keeping track of group membership.

IGMP Snooping

Listening to IGMP Query and IGMP Report packets transferred between IP Multicast Routers and IP Multicast host groups to learn IP Multicast group members.

In-Band Management

Management of the network from a station attached directly to the network.

IP Multicast Filtering

A process whereby this switch can pass multicast traffic along to participating hosts.

Layer 2

Data Link layer in the ISO 7-Layer Data Communications Protocol. This is directly related to the hardware interface for network devices and passes traffic based on MAC addresses.

Layer 3

Network layer in the ISO 7-Layer Data Communications Protocol. This layer handles the routing functions for data moving from one open system to another.

Link Aggregation

See Port Trunk.

Management Information Base (MIB)

An acronym for Management Information Base. It is a set of database objects that contains information about a specific device.

Multicast Switching

A process whereby the switch filters incoming multicast frames for services no attached host has registered for, or forwards them to all ports contained within the designated multicast VLAN group.

Open Shortest Path First (OSPF)

OSPF is a link state routing protocol that functions better over a larger network such as the Internet, as opposed to distance vector routing protocols such as RIP. It includes features such as unlimited hop count, authentication of routing updates, and Variable Length Subnet Masks (VLSM).

Out-of-Band Management

Management of the network from a station not attached to the network.

Port Mirroring

A method whereby data on a target port is mirrored to a monitor port for troubleshooting with a logic analyzer or RMON probe. This allows data on the target port to be studied unobtrusively.

Port Trunk

Defines a network link aggregation and trunking method which specifies how to create a single high-speed logical link that combines several lower-speed physical links.

Remote Monitoring (RMON)

RMON provides comprehensive network monitoring capabilities. It eliminates the polling required in standard SNMP, and can set alarms on a variety of traffic conditions, including specific error types.

Routing Information Protocol (RIP)

The RIP protocol attempts to find the shortest route to another device by minimizing the distance vector, or hop count, which serves as a rough estimate of transmission cost. RIP-2 is a compatible upgrade to RIP. It adds useful capabilities for subnet routing, authentication, and multicast transmissions.

Simple Network Management Protocol (SNMP)

The application protocol offering network management services in the Internet suite of protocols.

Serial Line Internet Protocol (SLIP)

Serial Line Internet Protocol, a standard protocol for point-to-point connections using serial lines.

Spanning Tree Protocol (STP)

A technology that checks your network for any loops. A loop can often occur in complicated or back-up linked network systems. Spanning-tree detects and directs data along the shortest path, maximizing the performance and efficiency of the network.

Telnet

Defines a remote communication facility for interfacing to a terminal device over TCP/IP.

Trivial File Transfer Protocol (TFTP)

A TCP/IP protocol commonly used for software downloads.

Virtual LAN (VLAN)

A Virtual LAN is a collection of network nodes that share the same collision domain regardless of their physical location or connection point in the network. A VLAN serves as a logical workgroup with no physical barriers, allowing users to share information and resources as though located on the same LAN.

XModem

A protocol used to transfer files between devices. Data is grouped in 128-byte blocks and error-corrected.