

User's Manual

ICA-HM101 / ICA-HM101W

**Wired / Wireless
H.264 Mega-Pixel IP Camera**



Copyright

Copyright © 2012 by PLANET Technology Corp. All rights reserved. No part of this publication may be reproduced, transmitted, transcribed, stored in a retrieval system, or translated into any language or computer language, in any form or by any means, electronic, mechanical, magnetic, optical, chemical, manual or otherwise, without the prior written permission of PLANET.

PLANET makes no representations or warranties, either expressed or implied, with respect to the contents hereof and specifically disclaims any warranties, merchantability or fitness for any particular purpose. Any software described in this manual is sold or licensed "as is". Should the programs prove defective following their purchase, the buyer (and not PLANET, its distributor, or its dealer) assumes the entire cost of all necessary servicing, repair, and any incidental or consequential damages resulting from any defect in the software. Further, PLANET reserves the right to revise this publication and to make changes from time to time in the contents hereof without obligation to notify any person of such revision or changes.

All brand and product names mentioned in this manual are trademarks and/or registered trademarks of their respective holders.

Federal Communication Commission Interference Statement

This equipment has been tested and found to comply with the limits for a Class B digital device, pursuant to Part 15 of FCC Rules. These limits are designed to provide reasonable protection against harmful interference in a residential installation. This equipment generates, uses, and can radiate radio frequency energy and, if not installed and used in accordance with the instructions, may cause harmful interference to radio communications. However, there is no guarantee that interference will not occur in a particular installation. If this equipment does cause harmful interference to radio or television reception, which can be determined by turning the equipment off and on, the user is encouraged to try to correct the interference by one or more of the following measures:

1. Reorient or relocate the receiving antenna.
2. Increase the separation between the equipment and receiver.
3. Connect the equipment into an outlet on a circuit different from that to which the receiver is connected.
4. Consult the dealer or an experienced radio technician for help.

FCC Caution

To assure continued compliance. (example-use only shielded interface cables when connecting to computer or peripheral devices). Any changes or modifications not expressly approved by the party responsible for compliance could void the user's authority to operate the equipment.

This device complies with Part 15 of the FCC Rules. Operation is subject to the Following two conditions: (1) This device may not cause harmful interference, and (2) this Device must accept any interference received, including interference that may cause undesired operation.

Federal Communication Commission (FCC) Radiation Exposure Statement

This equipment complies with FCC radiation exposure set forth for an uncontrolled environment. In order to avoid the possibility of exceeding the FCC radio frequency exposure limits, human proximity to the antenna shall not be less than 20 cm (8 inches) during normal operation.

Safety

This equipment is designed with the utmost care for the safety of those who install and use it. However, special attention must be paid to the dangers of electric shock and static electricity

when working with electrical equipment. All guidelines of this and of the computer manufacture must therefore be allowed at all times to ensure the safe use of the equipment.

CE Mark Warning

This is a Class B product. In a domestic environment, this product may cause radio interference, in which case the user may be required to take adequate measures.

WEEE Regulation



To avoid the potential effects on the environment and human health as a result of the presence of hazardous substances in electrical and electronic equipment, end users of electrical and electronic equipment should understand the meaning of the crossed-out wheeled bin symbol. Do not dispose of WEEE as unsorted municipal waste and have to collect such WEEE separately.

Revision

User's Manual for PLANET Wired/Wireless H.264 Mega-Pixel IP Camera
Model: ICA-HM101 / ICA-HM101W
Rev: 1.0 (April. 2012)
Part No. EM-ICAHM101 Series_v1.0

Table of Content

1. Introduction.....	5
1.1 Overview	5
1.2 Features	5
1.3 Package Contents	6
2. Basic Setup	7
2.1 System Requirement.....	7
2.2 Physical Description	8
2.2.1 Terminal Connections	8
2.2.2 Bottom Panel	9
2.2.3 Side Panel	11
2.3 Initial Utility Installation	13
2.4 Preparation.....	15
2.4.1 Search and View by PLANET IP Wizard II.....	15
2.5 Using UPnP of Windows XP or Vista.....	19
2.5.1 Windows XP	19
2.5.2 Windows Vista	23
2.6 Setup ActiveX to use the Internet Camera	24
2.6.1 Internet Explorer 6 for Windows XP	24
2.6.2 Internet Explorer 7 for Windows XP.....	25
2.6.3 Internet Explorer 7 for Windows Vista.....	26
3. Web-based Management	28
3.1 Introduction.....	28
3.2 Connecting to Internet Camera	28
3.3 Live View	30
3.4 ActiveX Control.....	32
3.4.1. Digital Zoom.....	33
3.4.2. Record	33
3.4.3. Snapshot.....	34
3.4.4. Volume.....	34
3.4.5. About	35
3.5 Network Configuration	35
3.5.1. Network.....	35
3.5.2. Wireless (ICA-HM101W only)	37
3.5.3. IPv6 function	41
3.5.4. HTTPS	42
3.5.5. DDNS server.....	42
3.5.6. PPPoE	44
3.5.7. Streaming.....	45
3.5.8. UPnP	46
3.5.9. Bonjour	47
3.5.10. ONVIF	48
3.5.11. IP Filter.....	49
3.5.12. IP Notification	50
3.6 Camera Configuration	52
3.6.1. Picture.....	52

3.6.2. Privacy Mask	54
3.7 System	55
3.7.1. System.....	55
3.7.2. Date & Time	56
3.7.3. Maintenance	57
3.8 Video	59
3.8.1. Common	59
3.8.2. Video Profile	60
3.8.3. ROI	61
3.9 Audio Configuration.....	62
3.10 User Privilege Access Configuration.....	63
3.11 E-Mail Configuration	64
3.12 Object Detection	65
3.13 Storage Configuration	66
3.14 Recording List.....	67
3.15 Continuous Recording	68
3.16 Event Server Configuration.....	69
3.16.1 FTP Server.....	69
3.16.2 TCP Server	70
3.16.3 HTTP Server	71
3.16.4 SAMBA Server	72
3.17 Event Schedule Configuration	73
3.18 Record Configuration.....	77
Appendix A: PING IP Address	78
Appendix B: 3GPP Access.....	79
Appendix C: Bandwidth and Video Size Estimation	80
Appendix D: DDNS Application.....	81
Appendix E: Configure Port Forwarding Manually	87
Appendix F: Power Line Frequency.....	77
Appendix G: Troubleshooting & Frequently Asked Questions.....	78
Appendix H: Product Specification	83

1. Introduction

PLANET has announced a 2 Mega-Pixel PoE Cube IP camera, ICA-HM101, for meeting the feedback from worldwide market. The ICA-HM101 with built-in high performance 2 Mega-Pixel CMOS sensor delivers high quality image at maximum UXGA (1600x1200) resolutions. Integrated the next generation video compression technology – H.264, the ICA-HM101 can compress the video size to smaller one for users to transfer the Mega-Pixel image on Internet easily. Multi-profile stands for video stream simultaneously. The ICA-HM101 can generate H.264 / MPEG-4 and M-JPEG streaming to different users at the same time. It allows up to 20 users to access the ICA-HM101 simultaneously. With this state-of-the-art design, the ICA-HM101 is considerable to fit in various network environments.

The ICA-HM101 features 0.5 lux illumination. 12 white LEDs built around the lens bring the clearest vision at night. The ICA-HM101 offers color pictures both in the day and night with built-in CMOS sensor supporting up to 10 meters. It also uses new High-Light LED to provide greater performance in the dark and longer life of LED.

Supports Store-to-NAS function, the ICA-HM101 can work alone and save the video file to a NAS directly, which can save the PC resource and keep monitoring the environment with motion detection at 7/24. The ICA-HM101's PIR motion sensor detects motion, images and voices are transmitted. The ICA-HM101 takes surveillance using 2-Way audio. The administrator can speak to anyone at ICA-HM101 remote site with a speaker connected. Compliant with IEEE 802.3af PoE interface, the ICA-HM101 can be located in places where there are no power outlets.

The ICA-HM101 can be managed by PLANET Cam Viewer Three, the professional management software for multi-camera video surveillance application, to provide monitoring, recording and event management functions. The Cam Viewer Plus enables you to setup a comprehensive and effective surveillance system quickly and easily. With the ICA-HM101 managed by the Cam Viewer Three, it provides an enhanced professional security environment to protect your property and life.

1.1 Overview

This user's guide explains how to operate this camera from a computer. User should read this manual completely and carefully before you operate the device

1.2 Features

- 2 Mega-Pixel CMOS sensor built-in

- 12 white-light LEDs support up to 10 meters visible distance at night

- 4.3mm Fixed Lens Provides 56 Degree Horizontal / 43 Degree Vertical Angle of View

- High Resolution Video Preview: UXGA (1600X1200) pixels

- Min Illumination : 0.5 lux @ F1.2

- Built-in PIR sensor (6m/120° coverage) for thermal/motion detection

- Intelligent motion detection up to 10 zones

- Multi-profile encoder supports H.264 / MPEG-4 and M-JPEG video compression simultaneously

Support both Variable Bit Rate and Variable Frame Rate
2 MP resolution or 720p mode selectable
Up to 30fps for 1280x720 resolution and up to 15fps for 1600x1200 resolutions
Digital WDR to provide clear images even under back light circumstances
3D de-noise to improve picture quality at low lux
2-Way audio with built-in microphone and speaker
Sensor input and alarm output
Easy configuration and management via Windows-based utility or web interface
IEEE 802.11n Wireless LAN Capability (ICA-HM101W only)
WEP/WPA/WPA2-PSK wireless security (ICA-HM101W only)
20-profile encoder simultaneously
UDP / TCP / HTTP / HTTPS protocols selectable
Cam Viewer Three - Central management software supported

1.3 Package Contents

User can find the following items in the package:

Camera unit x 1
Power Adapter x 1
Camera Mount Kit x 1
User's Manual CD x 1
Quick Installation Guide x 1
External Antenna x 1 (ICA-HM101W only)

-
- NOTE:**
1. *If any of the above items are missing, please contact your dealer immediately.*
 2. *Using the power supply that is not the one included in Internet Camera packet will cause damage and void the warranty for this product.*
-

2. Basic Setup

This chapter provides details of installing and configuring the Internet Camera.

2.1 System Requirement

The Internet Camera can be monitoring on all of Windows operating system that suggest with system requirement below in order to got better video performance.

Network Interface	10/100MBase-TX Ethernet
Monitoring System	Recommended for Internet Explorer 6.0 or later
System Hardware	<ul style="list-style-type: none">· CPU: Pentium 4, 3.6GHz or above· Memory Size : 1GB or more· VGA card resolution : 1280 x 1024 or higher· VGA card memory : 64 MB or above· Network bandwidth: In D1 resolution mode, minimum upload bandwidth is 1.5 ~ 2Mbps.

-
- NOTE:**
1. *The listed information is minimum system requirements only. Actual requirement will vary depending on the nature of your environment.*
 2. *The ICA-HM101 series can be managed by PLANET IP Wizard II if you want to configure more detail information and settings of PLANET IP Wizard II software please refer to the CD-ROM folder "**D:\Utility\IPWizardII\setup.exe**", assume D is your CD-ROM drive.*
-

2.2 Physical Description

2.2.1 Terminal Connections

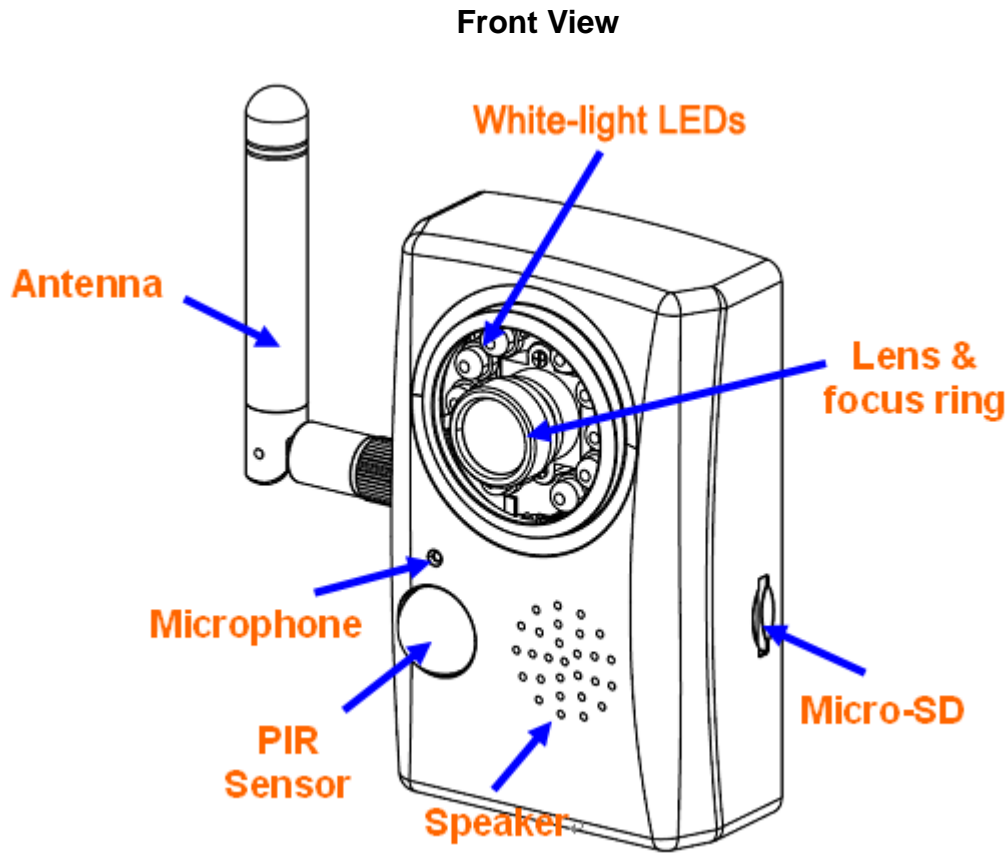

1	Antenna (ICA-HM101W only)	User can attach the included antenna to antenna connector (SMA type) or use another high-gain antenna to get higher performance.
2	White-light LEDs	These LEDs are White-light type by mode. It's very useful for low-lux environment to provide extra light source for image sensor
3	Lens & focus ring	User could use this ring to adjust focus manually.
4	Microphone	The Camera has built in an internal microphone. This microphone is hidden in the pinhole located on the front panel.
5	PIR Sensor	PIR sensor is used to sense motion or detect whether a human has moved in or out of the sensors range.
6	Micro SD Card Slot	User can insert a micro SD card into this slot for event recording.
7	Speaker	The Camera has built in a speaker. This speaker allows to output voice or alerting sound.

2.2.2 Bottom Panel

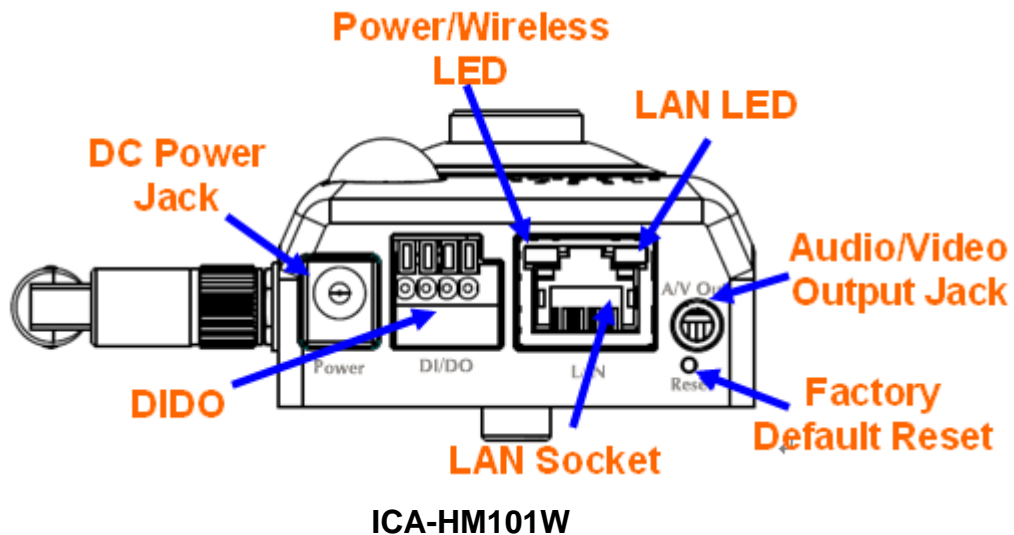
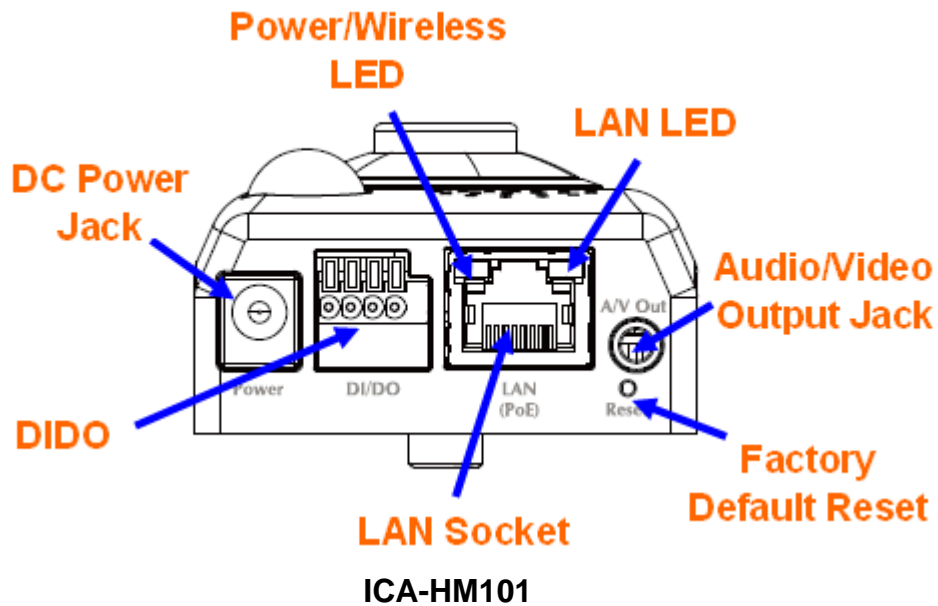

1.	Audio/Video Output Jack	<p>Audio/Video-out Jack allows this device to output audio and video signal. Use the attached A/V cable to connect A/V device where white cable is for audio and yellow cable is for video.</p> <p>The input power is 12VDC.</p>
2.	DC Power Jack	<p>Note that supply the power to the Camera with the power adapter included in package. Otherwise, the improper power adapter may damage the unit and result in danger.</p>

<p>3. Factory Default Reset</p>	<p>This button is hidden in the pinhole. This button is used to restore the all factory default settings. Sometimes restarting the camera will make the system back to a normal state. If the system still got problems after restart, user can restore the factory default settings and install it again. To restore the device, please follow the steps below:</p> <ol style="list-style-type: none"> 1. Make sure the Camera is ready first. Insert the paper clip or other tool and press and hold the button down continuously. 2. Hold it at least 5 seconds and release the tool while the Camera is operating. Then the device has been restored to default settings and reboot again. <p>Note: Restoring the factory default setting will lose the all previous settings included IP address forever. User needs to run the IPWizard II program to search the device and configure it to let the device work properly again.</p>
<p>4 LAN Socket</p>	<p>The LAN socket is a RJ-45 connector for connections to 10Base-T Ethernet or 100Base-TX Fast Ethernet cabling. This Ethernet port built N-Way protocol can detect or negotiate the transmission speed of the network automatically. Please use Category 5 cable to connect the Network Camera to a 100Mbps Fast Ethernet network switch or hub.</p>
<p>5 LAN LED (green color)</p>	<p>This LED is used to indicate whether the camera is ready or not. In addition, this LED will be flashing while the wireless accessing of the Camera (WLAN model only).</p>
<p>6 Power / Wireless LED (orange color)</p>	<p>The Camera has built in a speaker. This speaker allows to output voice or alerting sound.</p>
<p>7 DI/DO Connector</p>	<p>The Camera provides a terminal block with 4 pins of connectors for DI and DO. Please refer to the Appendix A in this manual for more information. The pin 1 is located at the left side of terminal block from rear view.</p>

2.2.3 Side Panel

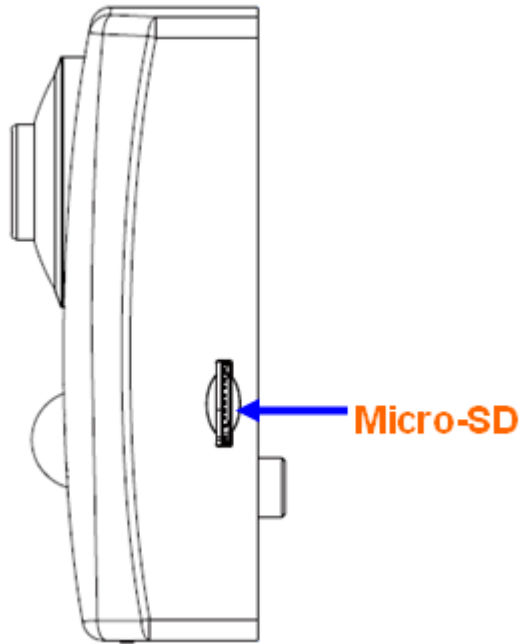

ICA-HM101/ICA-HM101W

1. **Micro-SD Card slot** User can insert a micro SD card into this slot for event recording.

Hardware Installation

1. Attach the Camera with the included stand

2. Place the Camera on the table or fix it onto ceiling or wall

Use three screws to fix the Network Camera onto the ceiling or wall. You could also put the Network Camera on the table directly.



3. Plug an Ethernet cable into the Camera

Connect an Ethernet cable to the LAN socket located on the Network Camera's bottom and attach it to the network.

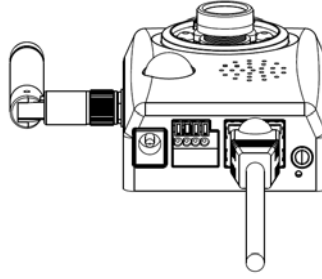

4. Connect the external power supply to Camera

Connect the attached power adapter to the DC power jack of the IP Camera. Note: Use the power adapter, 12VDC, included in the package and connect it to wall outlet for AC power.

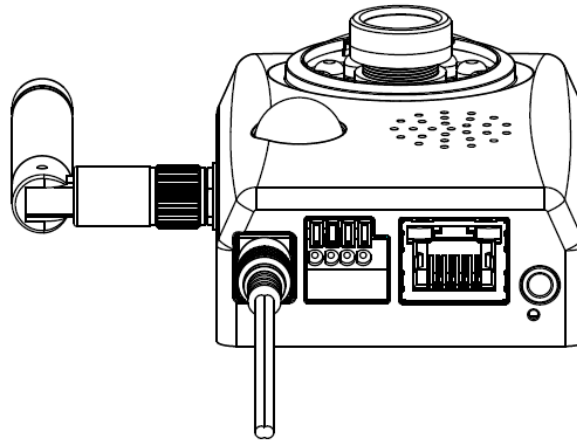

Once you have installed the IP Camera well and powered it on, the network accessing type LED will turn on. It means the system is booting up successfully. Furthermore, if you have a proper network connection, and access to the IP Camera, the LED will flash green under wired mode or orange under wireless mode.

2.3 Initial Utility Installation

This chapter shows how to quick set up your H.264 camera. The camera is with the default settings. However to help you find the networked camera quickly the windows utility PLANET IP Wizard II can search the cameras in the network that shall help you to configure some basic setting before you started advanced management and monitoring.

1. Insert the bundled CD into the CD-ROM drive to launch the auto-run program. Once completed, a welcome menu screen will appear.
2. Click the "IP Wizard II" hyperlink; you will see the dialog box as below.

NOTE: If the welcome screen does not appear, click “Start” at the taskbar. Then, select “Run” and type “D:\Utility\IPWizard II\setup.exe”, assume D is your CD-ROM drive.

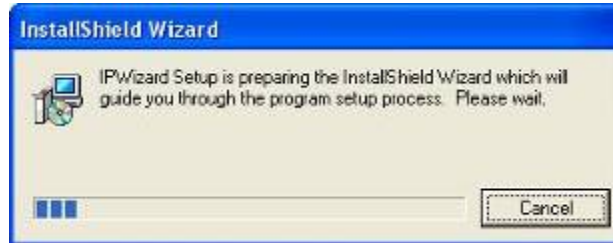

3. The “Welcome to the InstallShield Wizard for PLANET IP Wizard II” prompt will display on the screen and click “**Next**” to continue.



4. Please click “**Next**” to install with original settings, or you may click “**Change...**” button to modify the install folder then press “Next” to continue.

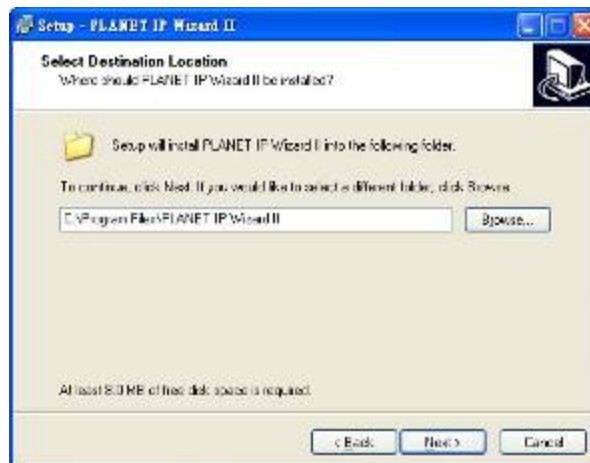

5. Please click **“Install”** to start the installation.



6. Please click **“Finish”** to complete the installation and launch program immediately.



2.4 Preparation

When you installed the Internet Camera on a LAN environment, you may execute PLANET IP Wizard II to discover camera's IP address and set up related parameters in the camera.

2.4.1 Search and View by PLANET IP Wizard II

When you installed the Internet Camera on a LAN environment, you have two easy ways to search your cameras by PLANET IP Wizard II or UPnP discovery. Here is the way to execute PLANET IP Wizard II to discover camera's IP address and set up related parameter in a camera.

✓ **Search**

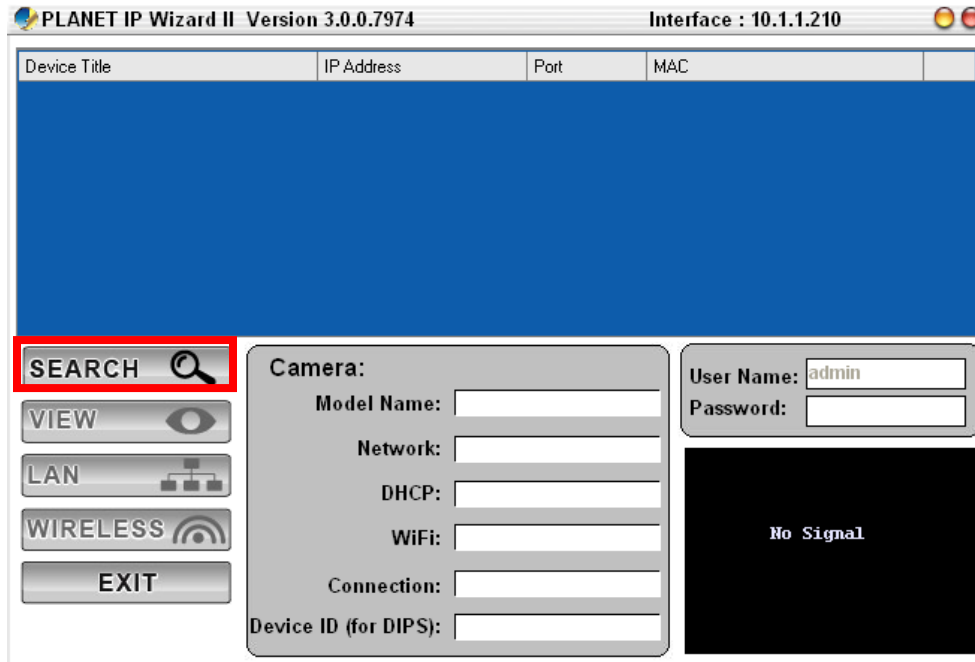

When launch the Planet IP Wizard II, a searching windows will pop up. Planet IP Wizard II is starting to searching Internet Cameras on the LAN. The existed devices will be listed as below.

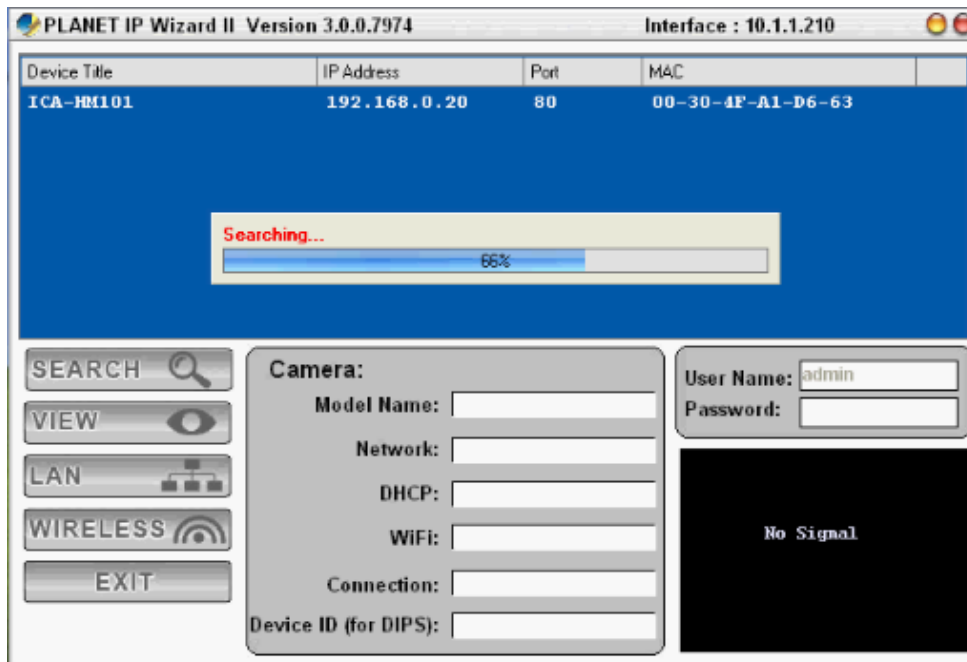

✓ View

If Planet IP Wizard II finds Internet Camera, View button will be available. Please select the camera you want to view and click the View button. Then you could see the Video from camera directly. Furthermore you could double click the left button of mouse to link to the Internet Camera by browser.

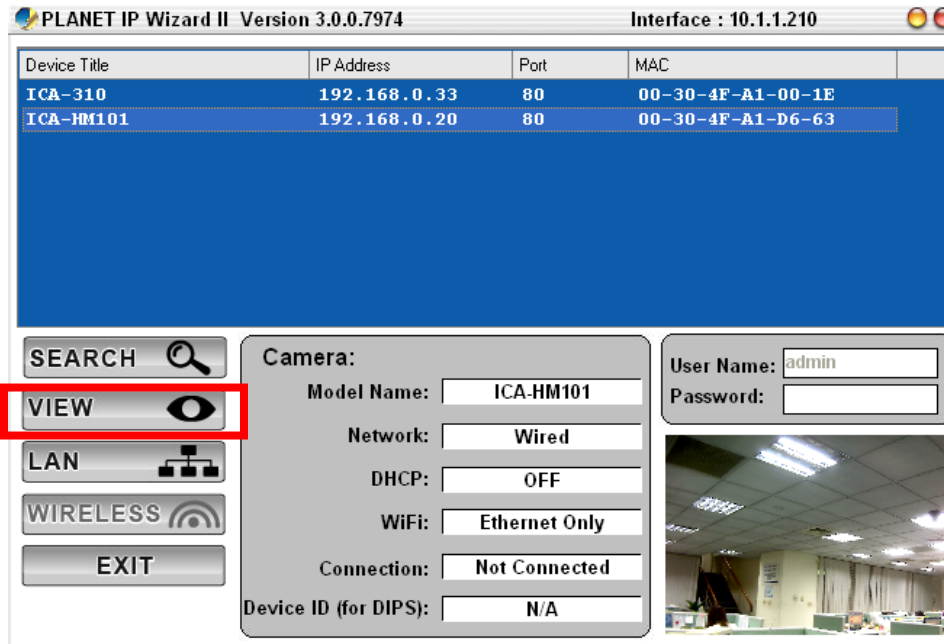

2.4.2 Configure Network by PLANET IP Wizard II

In case you want to change the IP related parameters of wired interface, please select the Internet Camera you want to configure and click the LAN button. Relative settings will be carried out as below.

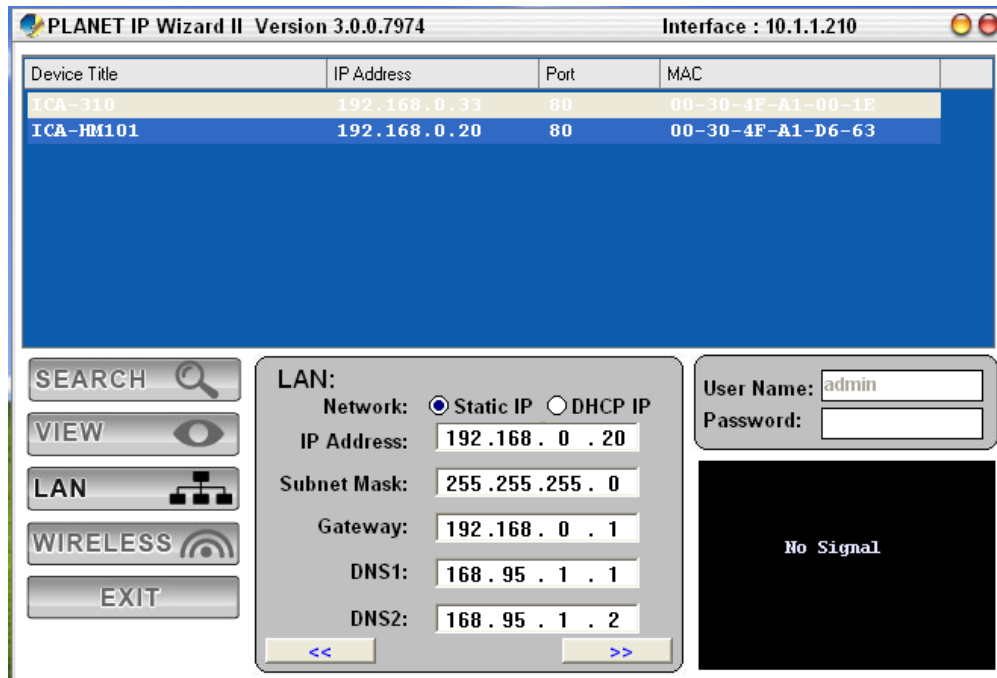

In case, you do not want to change username and/or password, then just click “**Submit**” button to perform your setting accordingly. Click “<<” button will go back to previous page. If you like to change username and/or password of the device, just click the check button. Then, the related fields will show up as below.

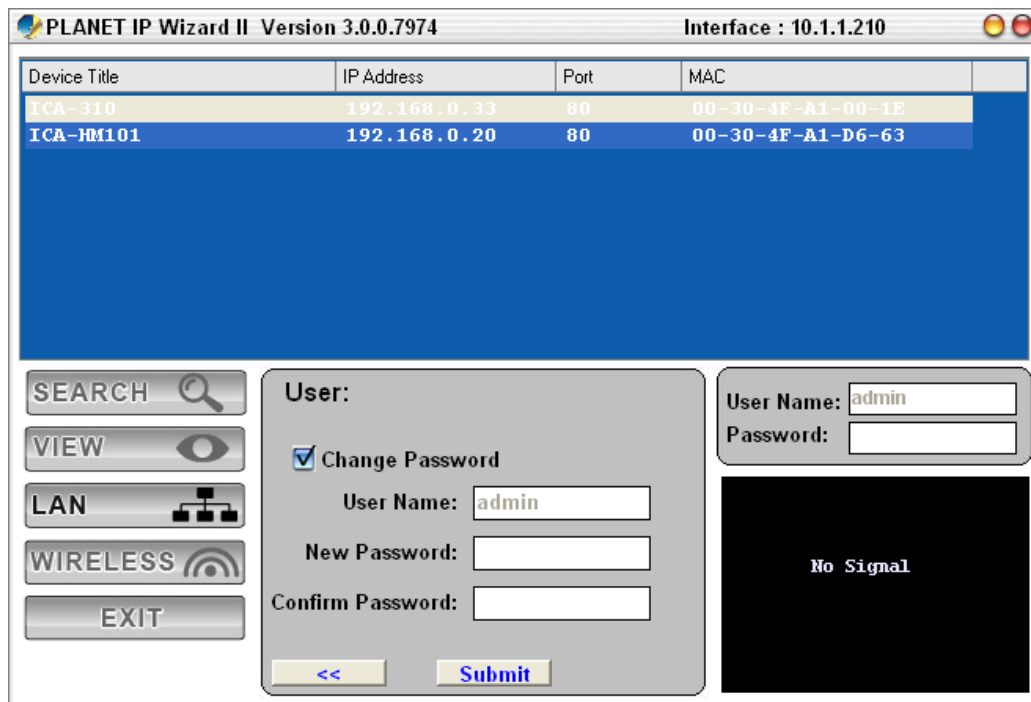

After keying in new username and password, click “**Submit**” button to perform your setting accordingly. Click “<<” button will go back to previous page.

2.5 Using UPnP of Windows XP or Vista

2.5.1 Windows XP

UPnP™ is short for Universal Plug and Play, which is a networking architecture that provides compatibility among networking equipment, software, and peripherals. This device is an UPnP enabled device. If the operating system, Windows XP, of your PC is UPnP enabled, the device will be very easy to configure. Use the following steps to enable UPnP settings only if your operating system of PC is running Windows XP.

NOTE: Please notice that MS Windows 2000 does not support UPnP feature.

Go to **Start > Settings**, and Click **Control Panel**.

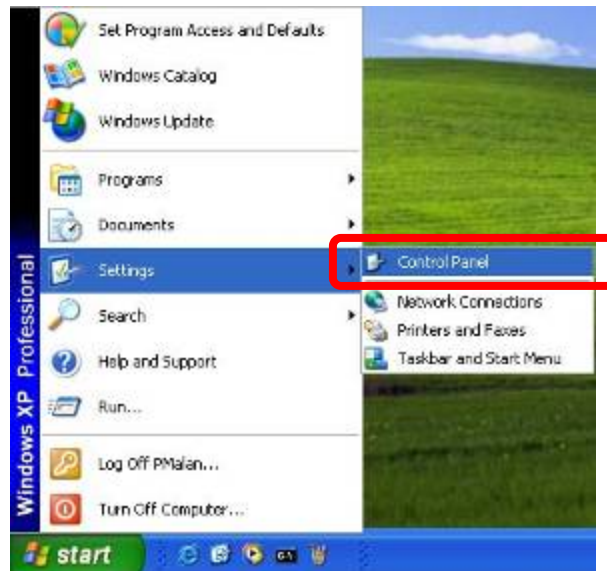

The **“Control Panel”** will display on the screen and double click **“Add or Remove Programs”** to continue.

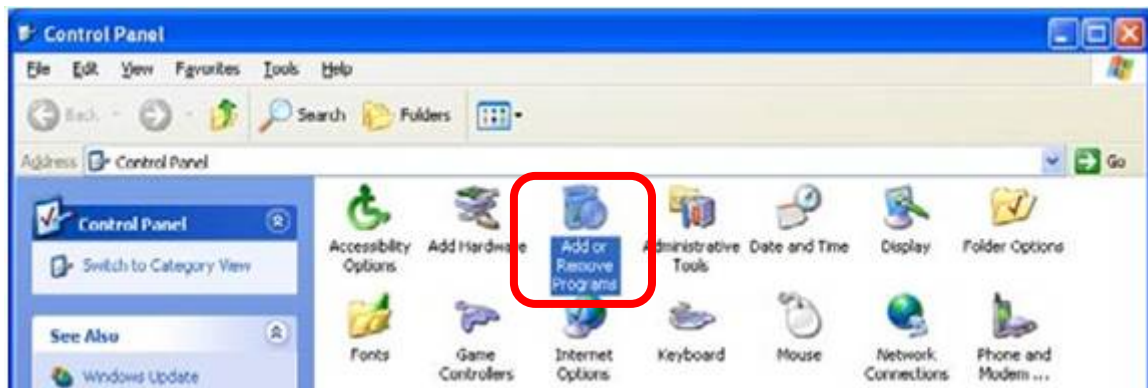

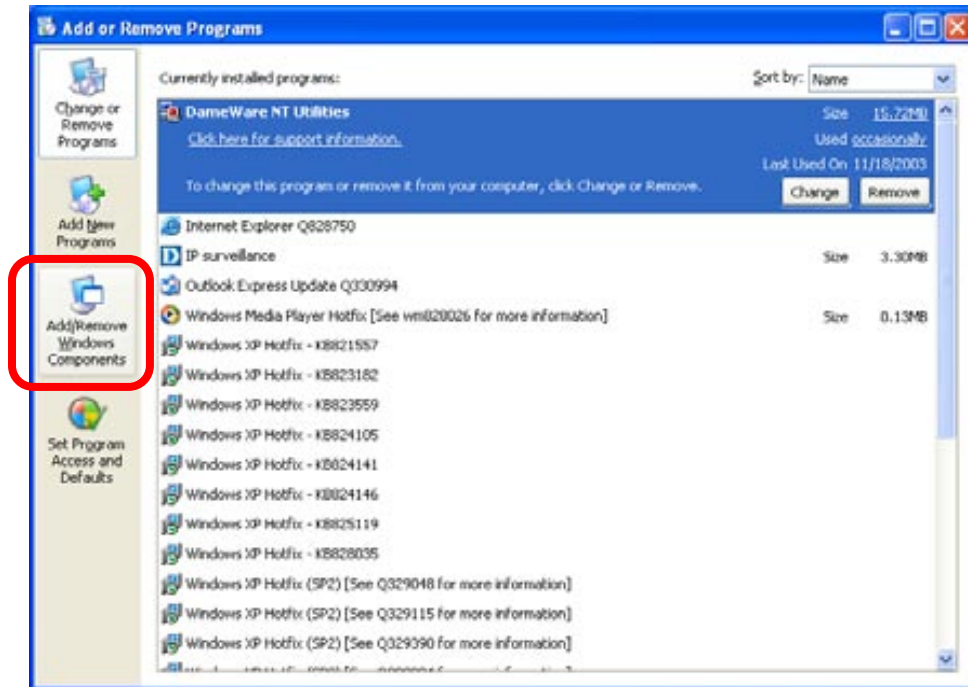

The following screen will appear, select **“Networking Services”** and click **“Details”** to continue.



The “Networking Services” will display on the screen, select **“Universal Plug and Play”** and click **“OK”** to continue.

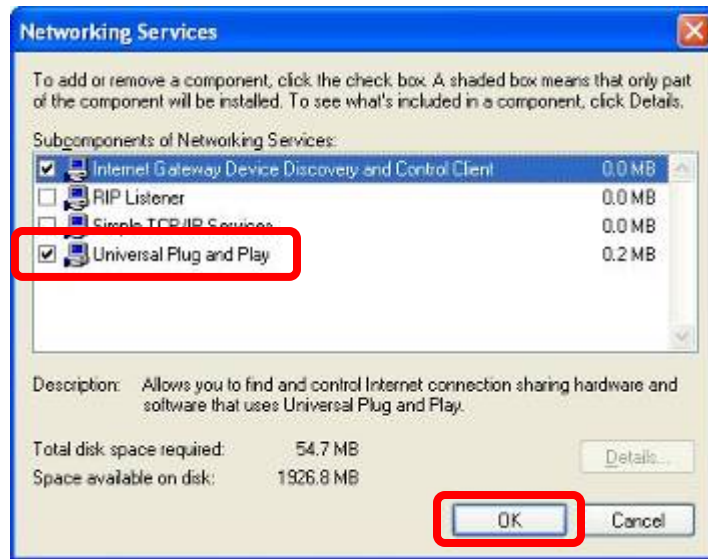

Please click **Next** to continue.



The program will start installing the UPnP automatically. You will see the below pop-up screen, please wait while Setup configures the components.

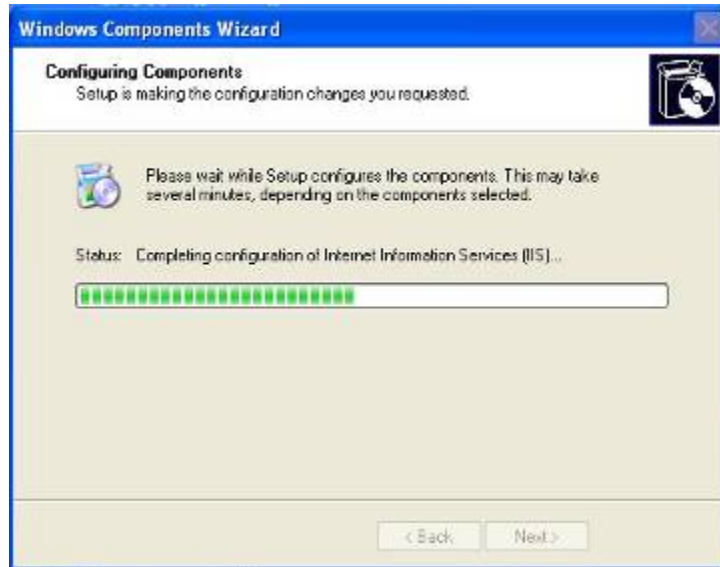

Please click **Finish** to complete the UPnP installation



Double-click **My Network Places** on the desktop, the "My Network Places" will display on the screen and double-click the UPnP icon with Internet Camera to view your device in an internet browser.

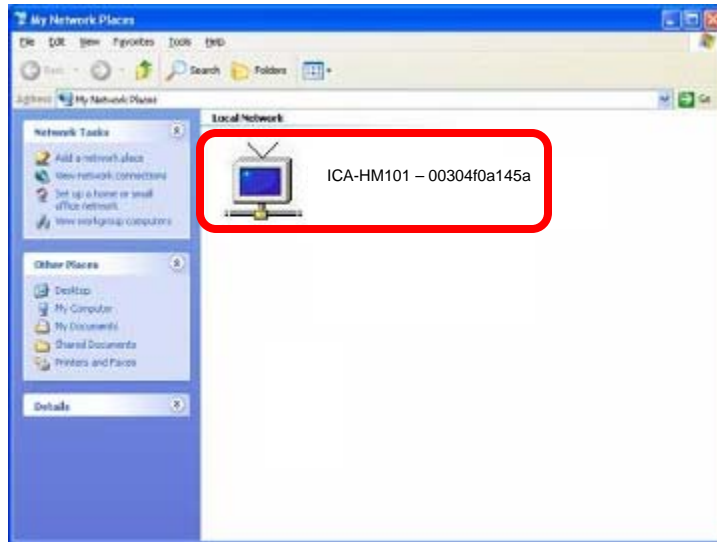

2.5.2 Windows Vista

UPnP™ is short for Universal Plug and Play, which is a networking architecture that provides compatibility among networking equipment, software, and peripherals. This device is an UPnP enabled device. If the operating system, Windows Vista, of your PC is UPnP enabled, the device will be very easy to configure. Use the following steps to enable UPnP settings only if your operating system of PC is running Windows Vista.

Go to **Start > Control Panel > Network and Internet > Network and Sharing Center**, and turn on **“Network Discovery”**.

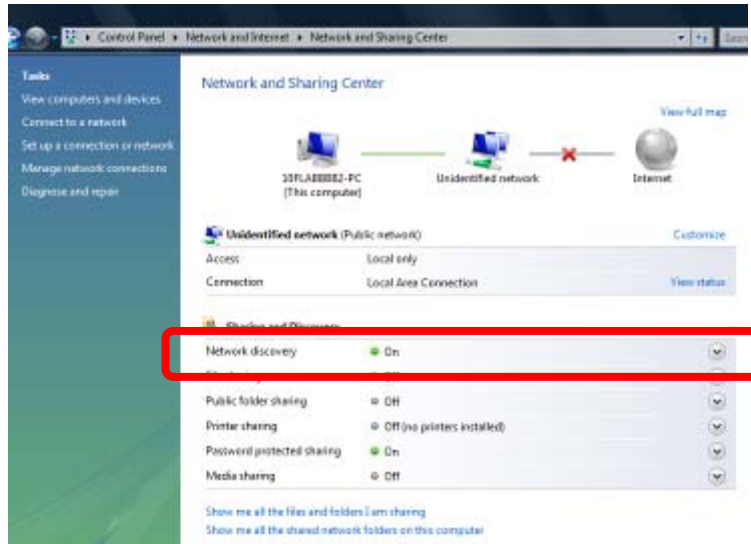

Double-click **"My Network Places"** on the desktop, the "My Network Places" will display on the screen and double-click the UPNP icon with Internet Camera to view your device in an internet browser.

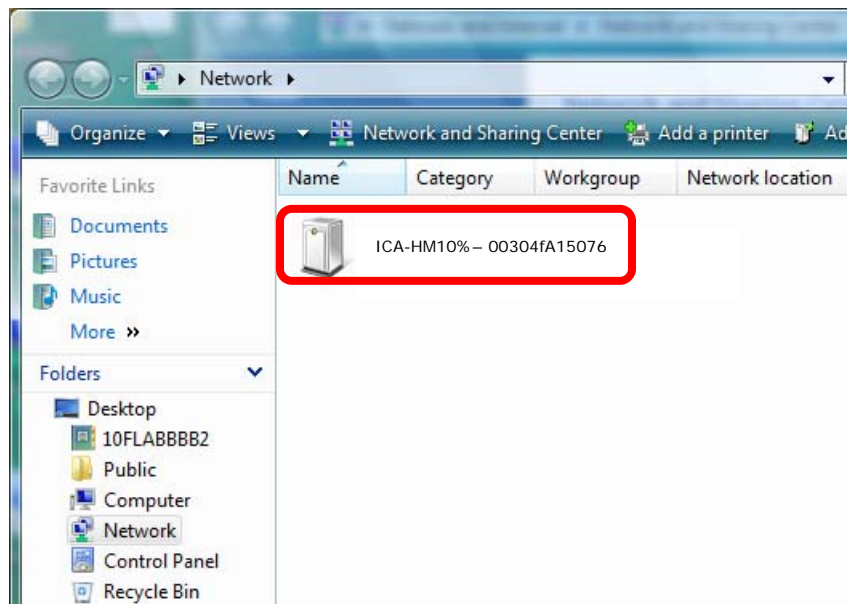

2.6 Setup ActiveX to use the Internet Camera

The Internet Camera web pages communicate with the Internet Camera using an ActiveX control. The ActiveX control must be downloaded from the Internet Camera and installed on your PC. Your Internet Explorer security settings must allow for the web page to work correctly. To use the Internet Camera, user must setup his IE browser as follows:

2.6.1 Internet Explorer 6 for Windows XP

From your IE browse → "Tools" → "Internet Options..." → "Security" → "Custom Level...", please

setup your “Settings” as follow.

Set the first 3 items

- *Download the signed ActiveX controls*
- *Download the unsigned ActiveX controls*
- *Initialize and script the ActiveX controls not masked as safe to Prompt*

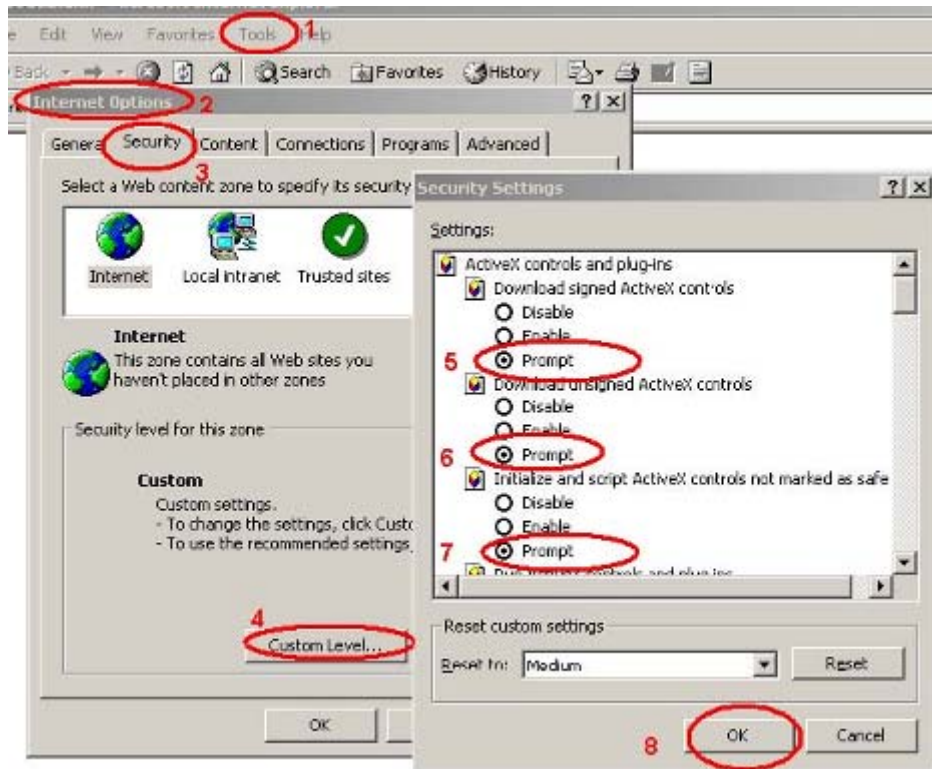

By now, you have finished your entire PC configuration for Internet Camera.

2.6.2 Internet Explorer 7 for Windows XP

From your IE browse → ”Tools” → ”Internet Options...” → ”Security” →”Custom Level...”, please setup your “Settings” as follow.

Set the first 3 items

- *Allow previously unused ActiveX control to run...*
- *Allows Script lets*
- *Automatic prompting for ActiveX controls*

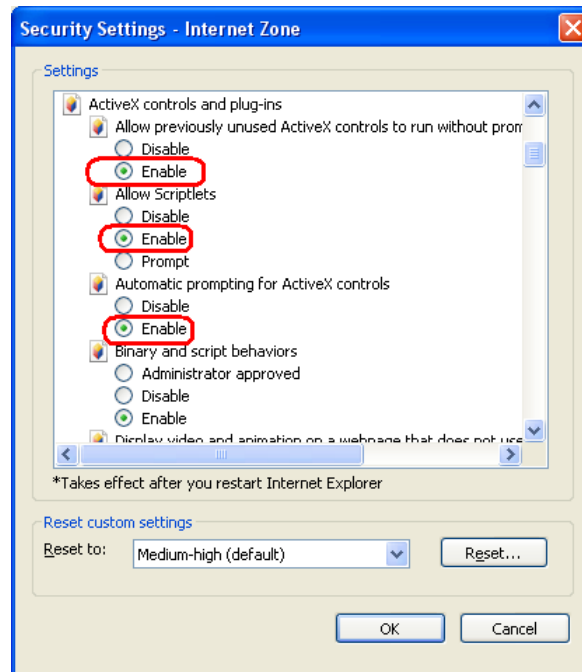

By now, you have finished your entire PC configuration for Internet Camera.

2.6.3 Internet Explorer 7 for Windows Vista

From your IE browse → "Tools" → "Internet Options..." → "Security" → "Internet" → "Custom Level...", please setup your "Settings" as follow.

- Enable "Automatic prompting for ActiveX controls"
- Prompt "Initialize and script active controls not marked as safe..."

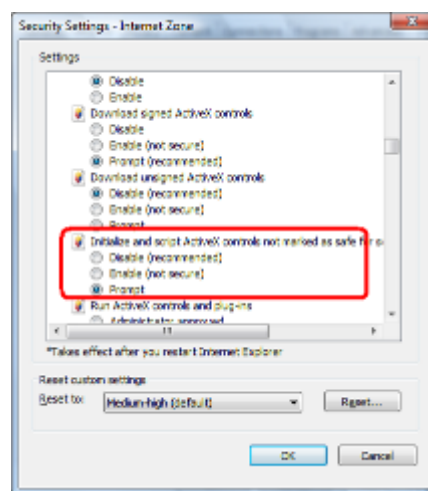
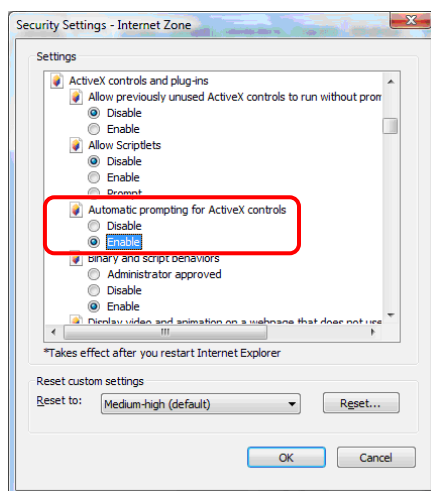

From your IE browse → "Tools" → "Internet Options..." → "Security" → "Trusted Sites" → "Custom Level...", please setup your "Settings" as follow.

- Enable “Automatic prompting for ActiveX controls”
- Prompt “Initialize and script active controls not marked...”

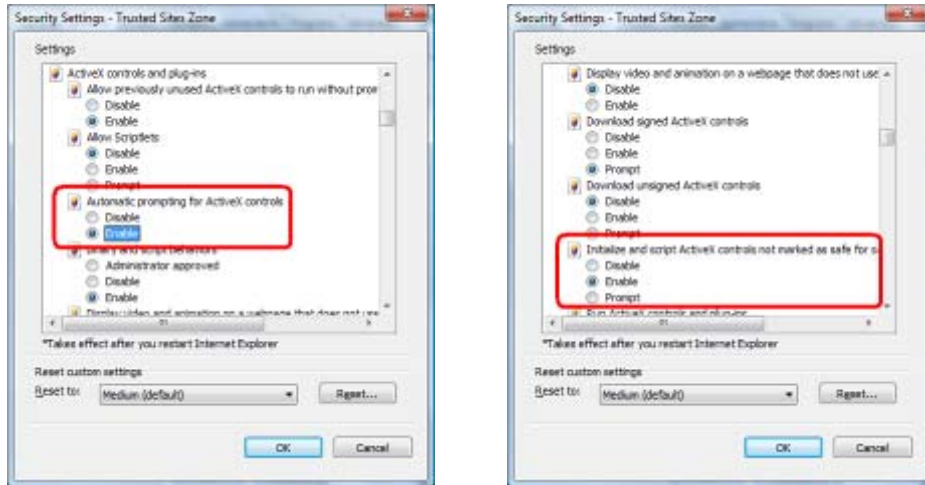

By now, you have finished your entire PC configuration for Internet Camera.

3. Web-based Management

This chapter provides setup details of the Internet Camera's Web-based Interface.

3.1 Introduction

The Internet Camera can be configured with your Web Browser. Before configure, please make sure your PC is under the same IP segment with Internet Camera.

3.2 Connecting to Internet Camera

- Use the following procedure to establish a connection from your PC to the Internet Camera.
- Once connected, you can add the camera to your Browser's Favorites or Bookmarks.

Start the web browser on the computer and type the IP address of the camera.
The Default IP: "<http://192.168.0.20/>"



The login window of Internet Camera will appear,
Default login **username/password** is: **admin / admin**



NOTE: *If the User name and Password have been changed with PLANET IP Wizard II, please enter the new User name and Password here.*

After logged on, you should see the following messages at the top of Internet Explorer:



Click on the message, and click **Install ActiveX Control...**

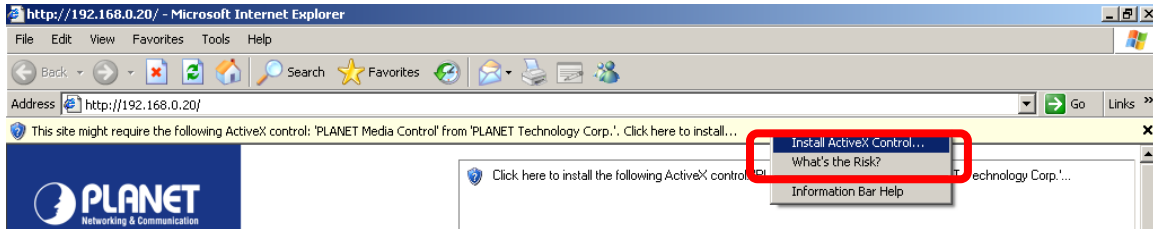

When you see this message, click **Install** to install required ActiveX control

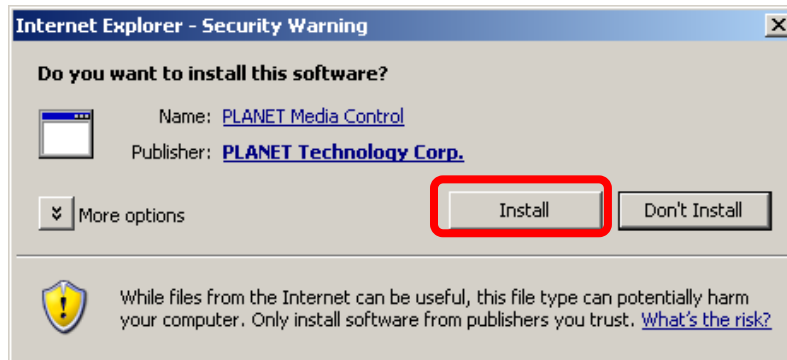

After the ActiveX control was installed and run, the first image will be displayed.

You should be able to see the images captured from the Internet Camera in the web page now. For advanced functions, please refer to instructions given in follows chapters.



If you log in the camera as an ordinary user, setting function will be not available.

NOTE: *you log in the camera as the administrator, you can perform all the settings provided within the device.*

3.3 Live View

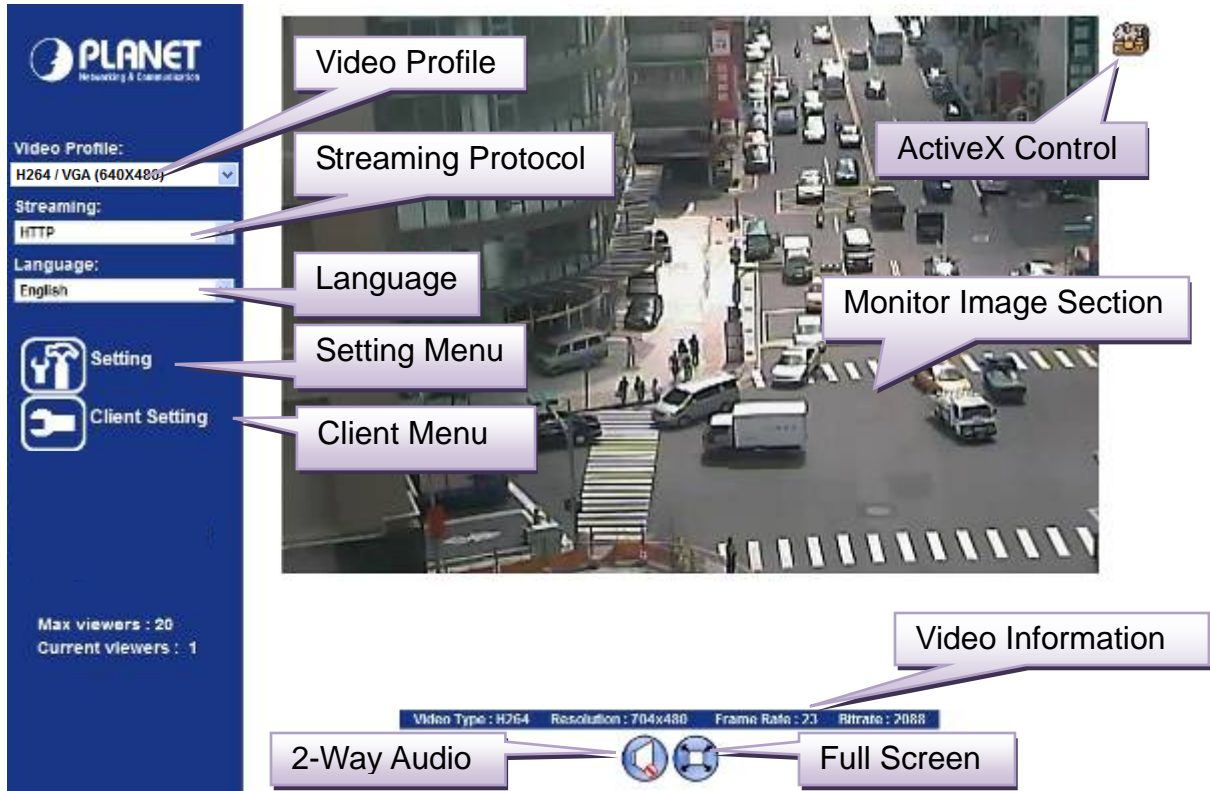
Start-up screen will be as follow no matter an ordinary users or an administrator.



Monitor Image Section	The image shot by the camera is shown here. The date and time are displayed at the top of the window.
Video Profile	The camera support multi-profile for three compressions H264, MPEG-4 and M-JPEG simultaneously. User can chose the proper and/or preferred profile here.
Full Screen	Click this button to display the image in full-screen mode (uses every available space to display the image captured by this camera).
2-Way Audio	The Internet Camera supports 2-way audio function. User can chose to enable or disable this function by toggling the icon below  : Disable audio uploading function.  : Enable audio uploading function.
ActiveX Control	The plug-in ActiveX control supports a lot of functions by clicking the left mouse button. Note that this feature only supports on the ActiveX

control within Microsoft® Internet Explorer.

Setting Menu

This function is detail setting for the camera that only available for user logged into camera as administrator.

Item	Action
Network	Configure Network settings such as Wireless, IPv6, ONVIF, DHCP, DDNS, 3GPP, PPPoE and UPnP.
Camera	Adjust camera parameters.
System	Configure system information, date & time, maintenance, and view system log file.
Video	Configure bit rate and frame rate of video profiles.
Audio	Configure audio parameters.
User	Setup user name, password and login privilege.
E-Mail	Setup E-Mail configuration.
Object Detection	Setup Object detection.
Storage	Status and configuration of SD card and Samba server.
Continuous Recording	Files list inside the SD Card and Samba server.
Recording List	Files list inside the SD Card.
Event Server	Setup FTP/TCP/HTTP/Samba server for event
Event Schedule	Configure the schedule while event triggered.

Streaming Protocol

User can select proper streaming protocol according to networking environment.

Language

The device could provide multiple languages to meet customer's requirement.

Client Setting:

Click this button to display the client extra control panel for 2-way Audio and Full Screen.

Video Information

Display video information including video format, resolution, frame rate and bit rate.

3.4 ActiveX Control

The plug-in ActiveX control supports a lot of functions by clicking the left mouse button. Note that this feature only supports on the ActiveX control within Microsoft® Internet Explorer.

On the ActiveX control icon, click the Left Mouse Button, then a menu pop-up. This menu provides features that are unique to the ActiveX control. These features include:

- Digital Zoom,
- Record,
- Snapshot,
- Voice,
- Statistics,
- About



3.4.1. Digital Zoom

Click **Digital Zoom** to activate this function as above. User can drag or scale the box over the video to adjust zoom ratio and position.

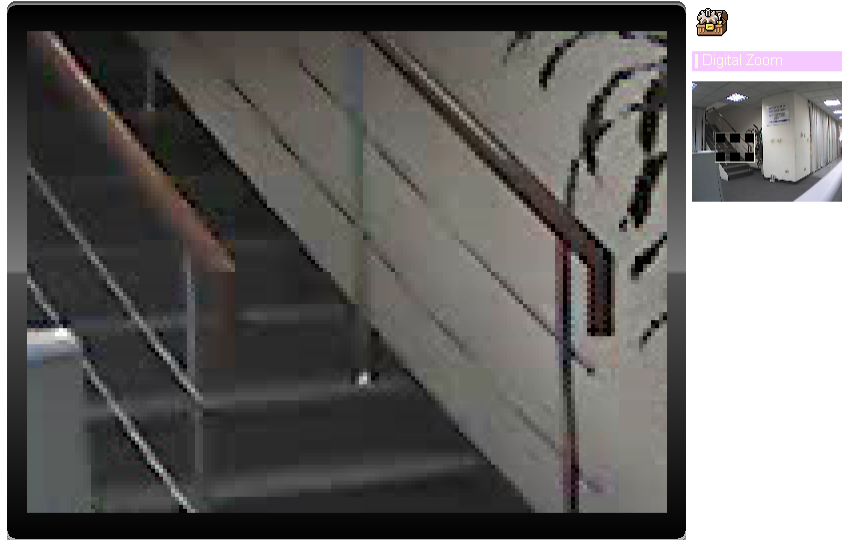

3.4.2. Record

Click **Record** to activate this function. Press **Record** button to start recording. The video file is saved as ASF format into your local PC. While you want to stop it, press **Stop** to stop recording. Select **Browser**, the pop-up window to select the save path and file name prefix, select **OK** to continue.

After stop recording, list the files, this file is named as Video_yyyymmddhhmmss.asf

The ASF files can be display by the standard Windows Media Player, but it needs the DixectX 9.0 or later version to be installed.

NOTE: Default save path is "C:\Documents and Settings\All user\Desktop"



3.4.3. Snapshot

Click **Snapshot** to activate this function. Press **Snapshot** button to take a picture. The image file is saved as JPEG format into your local PC. Select **Browser**, the pop-up window to select the save path and file name prefix, select **OK** to continue.

If you like to retrieve the saved image, select the file to display the saved image by using any one of graph editing tools.

NOTE: Default save path is "C:\Documents and Settings\All user\Desktop"



3.4.4. Volume

Click Volume to activate this function. These have two control bars for speaker and microphone volume. Scroll this control bar to adjust the audio attribute. Check the volume mute will mute the speaker output.



3.4.5. About

Click **About** to show the ActiveX information

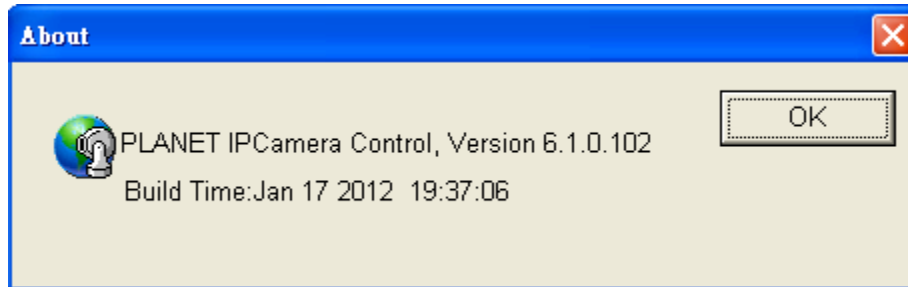

3.5 Network Configuration

Use this menu to configure the network to connect the device and the clients.

3.5.1. Network

This section provides the menu of connecting the device through Ethernet cable.

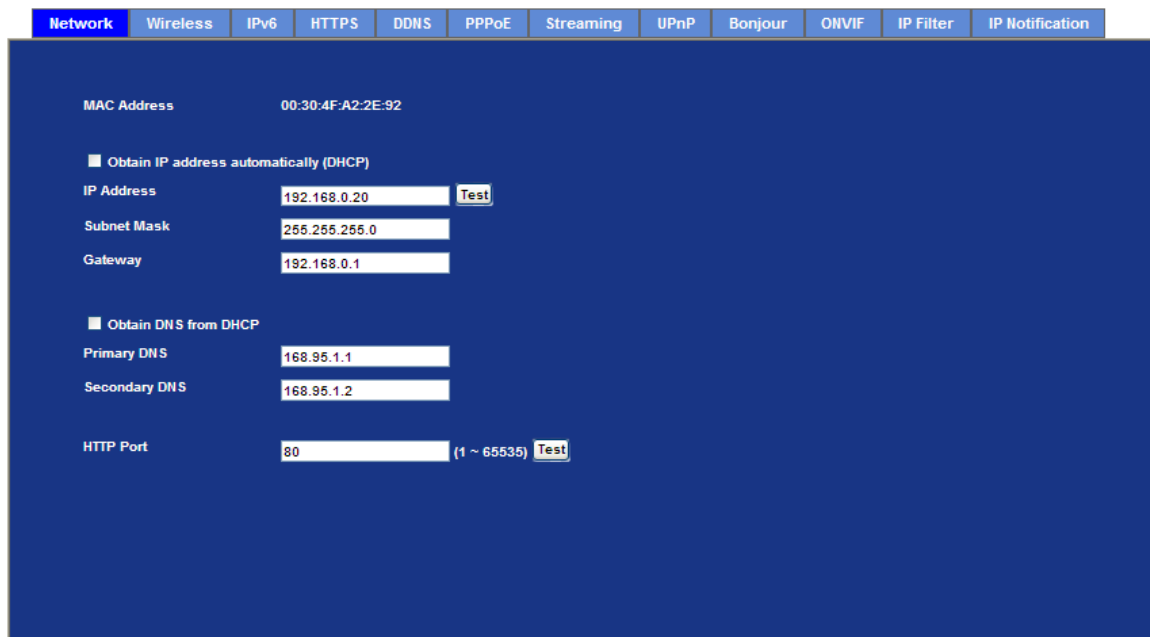

Network	Wireless	IPv6	HTTPS	DDNS	PPPoE	Streaming	UPnP	Bonjour	ONVIF	IP Filter	IP Notification
MAC Address	00:30:4F:A2:2E:92										
<input checked="" type="checkbox"/> Obtain IP address automatically (DHCP)											
IP Address	192.168.0.20 <input type="button" value="Test"/>										
Subnet Mask	255.255.255.0										
Gateway	192.168.0.1										
<input checked="" type="checkbox"/> Obtain DNS from DHCP											
Primary DNS	168.95.1.1										
Secondary DNS	168.95.1.2										
HTTP Port	80 (1 ~ 65535) <input type="button" value="Test"/>										

MAC address Display the Ethernet MAC address of the device. Note that user cannot change it.

Obtain an IP address automatically (DHCP) Enable this checked box when a DHCP server is installed on the network to issue IP address assignment. With this setting, the IP address is assigned automatically. If this device cannot get an IP

address within limited tries, the device will assign a default IP address for 192.168.0.20.

If you do not select “Obtain an IP address automatically”, then you need to enter these network parameters by yourself.

IP Address This address is a unique numbers that identifies a computer or device on the WAN or LAN. These numbers are usually shown in groups separated by periods, for example: 192.168.0.200

Subnet Mask Subnets allow network traffic between hosts to be separated based on the network's configuration. In IP networking, traffic takes the form of packets. IP subnets advance network security and performance to some level by organizing hosts into logical groups. Subnet masks contain four bytes and usually appear in the same "dotted decimal" data. For example, a very common subnet mask in its binary demonstration 11111111 11111111 11111111 00000000 will usually be shown in the corresponding, more readable form as 255.255.255.0.

Gateway A gateway is a piece of software or hardware that passes information between networks. You'll see this term most often when you either log in to an Internet site or when you're transient email between different servers.

Obtain DNS from DHCP Enable this checked box when a DHCP server is installed on the network and provide DNS service.

Primary DNS When you send email or position a browser to an Internet domain such as xxxxx.com, the domain name system translates the names into IP addresses. The term refers to two things: the conventions for naming hosts and the way the names are control across the Internet.

Secondary DNS The same function as DNS1. It is option not necessary

HTTP Port The device supports two HTTP ports. The first one is default port 80 and this port is fixed. This port is very useful for Intranet usage. The second HTTP port is changeable. Users could assign the second port number of http protocol, and the WAN users should follow the port number to login. If the http port is not assigned as 80, users have to add the port number in back of IP address. For example: <http://192.168.0.20:8080>.

Therefore, the user can access the device by either <http://xx.xx.xx.xx/>, or <http://xx.xx.xx.xx:xxxx/> to access the device.

If multiple devices are installed on the LAN and also required to be accessed from the WAN, then the **HTTP Port** can be assigned as the virtual server port mapping to support multiple devices.

NOTE When the configuration is finish, please click “**OK**” to save and enable the setting.

3.5.2. Wireless (ICA-HM101W only)

If your device is a wireless model, you could assign the related parameters into wireless setting. Using a wired connection ensures greater secrecy while making these settings. These settings should always be made in the camera first and secondly in the wireless access point. This ensures that the device is always accessible when making changes. **Note** that this function is only available for the model with WLAN capability.

The screenshot shows the 'Wireless' configuration page. At the top, there are tabs for Network, Wireless, IPv6, HTTPS, DDNS, PPPoE, Streaming, UPnP, Bonjour, ONVIF, IP Filter, and IP Notification. The 'Wireless' tab is active. Below the tabs, there are sections for WPS (with a 'Start PBC' button), Setting (with an 'Easy Installation' button), and Site Survey (with a table of detected networks and a 'Reload' button). The 'MAC Address' is displayed as 74:2F:68:92:2A:96. Under 'Interface Select', 'Auto - wired if cable connected, otherwise wireless' is selected. The 'Type' is set to 'Infrastructure'. The 'SSID' is ADW-4401, and the 'BSSID' is 00:30:4F:7E:48:60. The 'Channel' is set to 'BTSI, Europe' and 'AUTO'. The 'Security Mode' is 'None'. At the bottom, there are fields for 'Obtain IP address automatically (DHCP)', 'IP Address' (192.168.1.2), 'Subnet Mask' (255.255.255.0), and 'Gateway'.

Start PBC Click Start PBC to make instant connection to wireless AP.

Easy Installation Click to install wireless connection

MAC address Displays the Ethernet MAC address of the WLAN card. Note that user can not change it.

Site survey Click the “Reload” button. It will refresh information window which list is the result of a network scan. Access points with a disabled SSID Broadcast will not appear unless the camera is associated with it. The following information is provided:

Interface Select “Wired (Ethernet) only” or “Auto – wired if cable connected, otherwise

	wireless”: Choose wired or wireless mode. However, note that wired is priority.
Type	To select one of WLAN modes from Infrastructure or Ad-Hoc mode.
Security mode	Shows which type of security the network uses. The device supports three security methods: None, WEP, WPA_PSK, WPA2_PSK
Obtain DNS from DHCP	Enable this checked box when a DHCP server is installed on the network and provide DNS service.
SSID	This is the name of the wireless network the device is configured for. The field accepts up to 32 alphanumeric characters. The name must be exactly the same as that used in the wireless access point, or the connection will not be established. Leaving this field blank means the device will attempt to access the nearest open network.
Channel	Chooses the wireless channel in use currently.
WEP settings	<p>- Authentication:</p> <p>Select Open or Shared Key System Authentication, depending on the method used by your access point. Not all access points have this option, in which case they probably use Open System, which is sometimes known as SSID Authentication.</p> <p>- WEP Mode:</p> <p>The key types available depend on the access point being used. The following options are available:</p> <ul style="list-style-type: none"> •ASCII - In this method the string must be exactly 5 characters for 64-bit WEP and 13 characters for 128-bit WEP. •HEX - In this method the string must be exactly 10 hexadecimal (0-9, A-F) characters for 64-bit WEP and 26 hexadecimal characters for 128-bit WEP. <p>- Web Key 1~4:</p> <p>Key value of WEP.</p>
WPA settings	<p>- WPA Key:</p> <p>Key value of WPA. The device uses a pre-shared key (PSK) for key management. The pre-shared key can be entered either as Manual hex, as 64 hexadecimal characters, or as a Passphrase, using 8 to 63 ASCII characters.</p>

Obtain IP address automatically (DHCP) Enable this checked box when a DHCP server is installed on the network to issue IP address assignment. With this setting, the IP address is assigned automatically.

IP address, Subnet mask, and Gateway If you do not select Obtain an IP address automatically, then you need to enter these network parameters manually.

NOTE When the configuration is finish, please click “OK” to save and enable the setting.

Note: To enable WLAN function, user must set these related parameters correctly at first. Then power off the device and remove Ethernet cable from device. Power on the device again and WLAN mode will be available accordingly.

Wireless configuration step

1. Press Reload button detects wireless AP.
2. Press Easy Installation to into setup procedure.

Network **Wireless** IPv6 HTTPS DDNS PPPoE Streaming UPnP Bonjour ONVIF IP Filter IP Notification

Step 1 : Please click the table to choose the SSID!

Site Survey

MAC Address	SSID	Type	Channel	Encryption	Signal Strength
00:30:4F:7E:48:81	KAM	Infrastructure	6	WPA2PSK	20
00:30:4F:7E:48:80	ADW-4401	Infrastructure	6	WPA2PSK	13

Reload

SSID: default

Back Go Step 2

3. Fill correct SSID then press Go Step 2 button.

Network **Wireless** IPv6 HTTPS DDNS PPPoE Streaming UPnP Bonjour ONVIF IP Filter IP Notification

Step 1 : Please click the table to choose the SSID!

Site Survey

MAC Address	SSID	Type	Channel	Encryption	Signal Strength
00:30:4F:7E:48:80	ADW-4401	Infrastructure	2	WPA2PSK	20
00:30:4F:7E:48:81	KAM	Infrastructure	2	WPA2PSK	23

Reload

SSID: ADW-4401

Back Go Step 2

4. Select correct security and WPA mode and WPA key then press Submit button.

Network	Wireless	IPv6	HTTPS	DDNS	PPPoE	Streaming	UPnP	Bonjour	ONVIF	IP Filter	IP Notification
---------	----------	------	-------	------	-------	-----------	------	---------	-------	-----------	-----------------

Step 2 : Please input the authentication information!

SSID:

Security Mode: None WEP WPA_PSK/WPA2_PSK

WPA Mode:

WPA Key:
(ASCII: 8~63 Digits; HEX: 64 Digits)

5. ICA-HM101W restarting to enable wireless function.

Network	Wireless	IPv6	HTTPS	DDNS	PPPoE	Streaming	UPnP	Bonjour	ONVIF	IP Filter	IP Notification
---------	----------	------	-------	------	-------	-----------	------	---------	-------	-----------	-----------------

Change wireless config

Please wait 77 seconds

6. Wait for wireless ready

Network	Wireless	IPv6	HTTPS	DDNS	PPPoE	Streaming	UPnP	Bonjour	ONVIF	IP Filter	IP Notification
---------	----------	------	-------	------	-------	-----------	------	---------	-------	-----------	-----------------

Microsoft Internet Explorer

Waiting for wireless ready...
Please confirm the wireless setting!

7. Plug out cable to enable wireless function

Network	Wireless	IPv6	HTTPS	DDNS	PPPoE	Streaming	UPnP	Bonjour	ONVIF	IP Filter	IP Notification
---------	----------	------	-------	------	-------	-----------	------	---------	-------	-----------	-----------------

Microsoft Internet Explorer

Please remove the lan cabell

3.5.3. IPv6 function

Internet Protocol version 6 (IPv6) is called the “IP Next Generation” (IPng), which is designed to fix the shortcomings of IPv4, such as data security and maximum number of user addresses. It is backward compatible and thus expected to slowly replace IPv4, with the two existing side by side for many years.

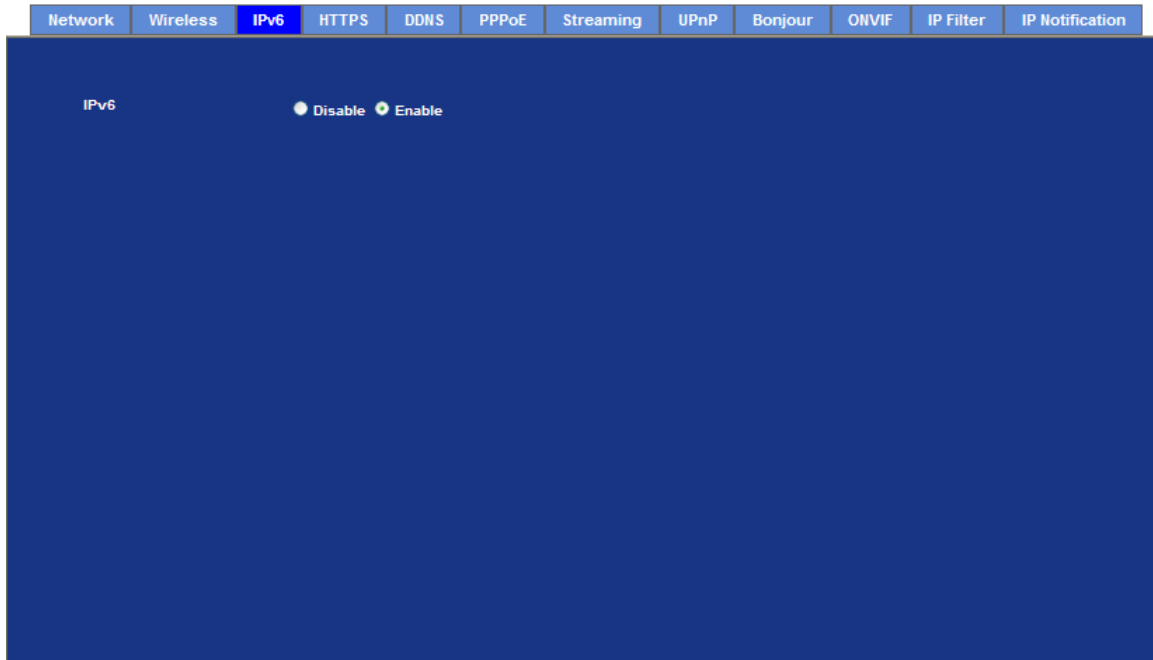

IPv6

To enable or disable the IPv6 function here.

3.5.4. HTTPS

HTTPS: Stands for Hypertext Transfer Protocol Secure

HTTPS is a combination of the Hypertext Transfer Protocol with the SSL/TLS protocol to provide encrypted communication and secure identification of a network web server. HTTPS connections are often used for sensitive transactions in corporate information systems. The main idea of HTTPS is to create a secure channel over an insecure network. This ensures reasonable protection from eavesdroppers and man-in-the-middle attacks, provided that adequate cipher suites are used and that the server certificate is verified and trusted.

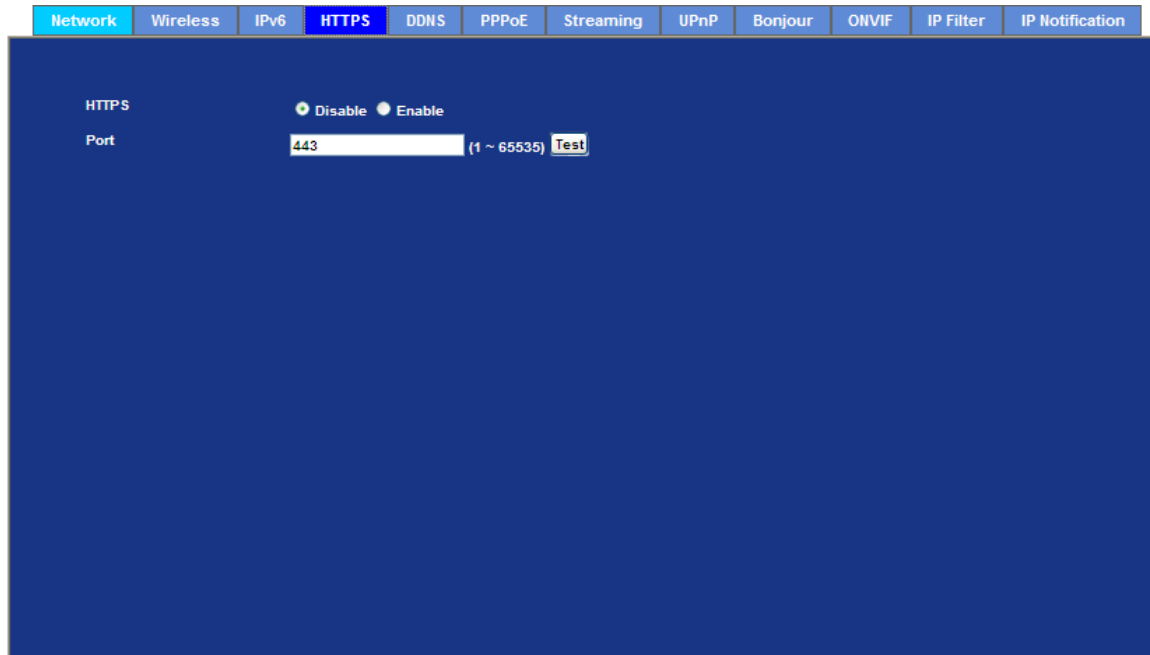

HTTPS

To enable or disable the HTTPS service here. Note that the HTTPS function of this device is not only encrypted the web content but also audio/video data.

Port

Choose the HTTPS port. The default value is 443.

3.5.5. DDNS server

Stands for Dynamic Domain Name Server

The device supports DDNS. If your device is connected to xDSL directly, you might need this feature. However, if your device is behind a NAT router, you will not need to enable this feature. Because DDNS allows the device to use an easier way to remember naming format rather than an IP address. The name of the domain is like the name of a person, and the IP address is like his phone number. On the Internet we have IP numbers for each host (computer, server, router, and so on), and we replace these IP numbers to easy remember names, which are organized into the domain name. As to xDSL environment, most of the users will use dynamic IP addresses. If users want to set up a web or a FTP server, then the Dynamic Domain Name Server is necessary. For more DDNS configuration, please consult your dealer.

Your Internet Service Provider (ISP) provides you at least one IP address which you use to connect to the Internet. The address you get may be static, meaning it never changes, or dynamic, meaning it's likely to change periodically. Just how often it changes, depends on your ISP. A dynamic IP address complicates remote access since you may not know what your current WAN IP address is when you want to access your network over the Internet. The solution to the dynamic IP address problem comes in the form of a dynamic DNS service.

The Internet uses DNS servers to lookup domain names and translates them into IP addresses. Domain names are just easy to remember aliases for IP addresses. A dynamic DNS service is unique because it provides a means of updating your IP address so that your listing will remain current when your IP address changes. There are several excellent DDNS services available on the Internet and best of all they're free to use. One such service you can use is www.DynDNS.org. You'll need to register with the service and set up the domain name of your choice to begin using it. Please refer to the home page of the service for detailed instructions or refer to Appendix E for more information.

Network Wireless IPv6 HTTPS **DDNS** PPPoE Streaming UPnP Bonjour ONVIF IP Filter IP Notification

DDNS Disable Enable

Server Name PLANET DDNS

DDNS Host .planetddns.com (6 ~ 16 Digits)

User Name (6~16 Digits)

Password (6~16 Digits)

Internet Status —

DDNS To enable or disable the DDNS service here.

Server name Choose the built-in DDNS server.

DDNS Host The domain name is applied of this device.

User Name The user name is used to log into DDNS.

Password The password is used to log into DDNS.

3.5.6. PPPoE

PPPoE: Stands for Point to Point Protocol over Ethernet

A standard builds on Ethernet and Point-to-Point network protocol. It allows Internet Camera connect to Internet with xDSL or cable connection; it can dial up your ISP and get a dynamic IP address. For more PPPoE and Internet configuration, please consult your ISP.

It can directly connect to the xDSL, however, it should be setup on a LAN environment to program the PPPoE information first, and then connect to the xDSL modem. Power on again, then the device will dial on to the ISP connect to the WAN through the xDSL modem.

The procedures are

- Connect to a LAN by DHCP or Fixed IP
- Access the device, enter **Setting** → **Network** → **PPPoE** as below

Network Wireless IPv6 HTTPS DDNS **PPPoE** Streaming UPnP Bonjour ONVIF IP Filter IP Notification

PPPoE Disable Enable

User Name (< 65 Digits)

Password (< 65 Digits)

IP Address (readonly)

Subnet Mask (readonly)

Gateway (readonly)

Status (readonly)

PPPoE To enable or disable the PPPoE service here.

User Name Type the user name for the PPPoE service which is provided by ISP.

Password Type the password for the PPPoE service which is provided by ISP.

IP Address / Subnet Mask / Gateway Shows the IP information got from PPPoE server site.

Status Shows the Status of PPPoE connection.

3.5.7. Streaming

RTSP is a streaming control protocol, and a starting point for negotiating transports such as RTP, multicast and Unicast, and for negotiating codecs. RTSP can be considered a "remote control" for controlling the media stream delivered by a media server. RTSP servers typically use RTP as the protocol for the actual transport of audio/video data.

Network Wireless IPv6 HTTPS DDNS PPPoE **Streaming** UPnP Bonjour ONVIF IP Filter IP Notification

RTSP Port (554 ~ 65535)

RTP Port ~ (1024 ~ 65535)

RTSP Port Choose the RTSP port. The RTSP protocol allows a connecting client to start a video stream. Enter the RTSP port number to use. The default value is 554.

RTP Port Specify the range of transmission port number of video stream. The default range is 50000 to 50999. User can specify a number between 1024 and 65535.

- NOTE**
1. To use the 3GPP function, in addition to previous section, you might need more information or configuration to make this function work.
 2. The camera must be set as Multi-profile mode, not Mega-pixel mode. Otherwise this device cannot serve 3GPP stream.
 3. To use the 3GPP function, it strongly recommends installing the Networked Device with a public and fixed IP address without any firewall protection.
 4. Port 554 is the default for RTSP service. However, sometimes, some service providers change this port number for some reasons. If so, user needs to change this port accordingly.

Dialing procedure 1. Choose a verified player (PacketVideo, Quicktime or Realplayer currently)
 2. Use the following URL to access: **rtsp://host/mpeg4/media.3gp**
 Where host is the host name or IP address of the camera.

Compatible 3G mobile phone Please contact your dealer to get the approved list of compatible 3G phone.

3.5.8. UPnP

UPnP is short for Universal Plug and Play, which is a networking architecture that provides compatibility among networking equipment, software, and peripherals. This device is an UPnP enabled Internet Camera. If your operating system is UPnP enabled, the device will automatically be detected and a new icon will be added to “My Network Places.” If you do not want to use the UPnP functionality, it can be disabled

In addition, this device also provides UPnP IGD function for NAT traversal easily. Use NAT traversal when your device is located on an intranet (LAN) and you wish to make it available from the other (WAN) side of a NAT router. With NAT traversal properly configured, all HTTP traffic to an external HTTP port in the NAT router will be forwarded to the device.

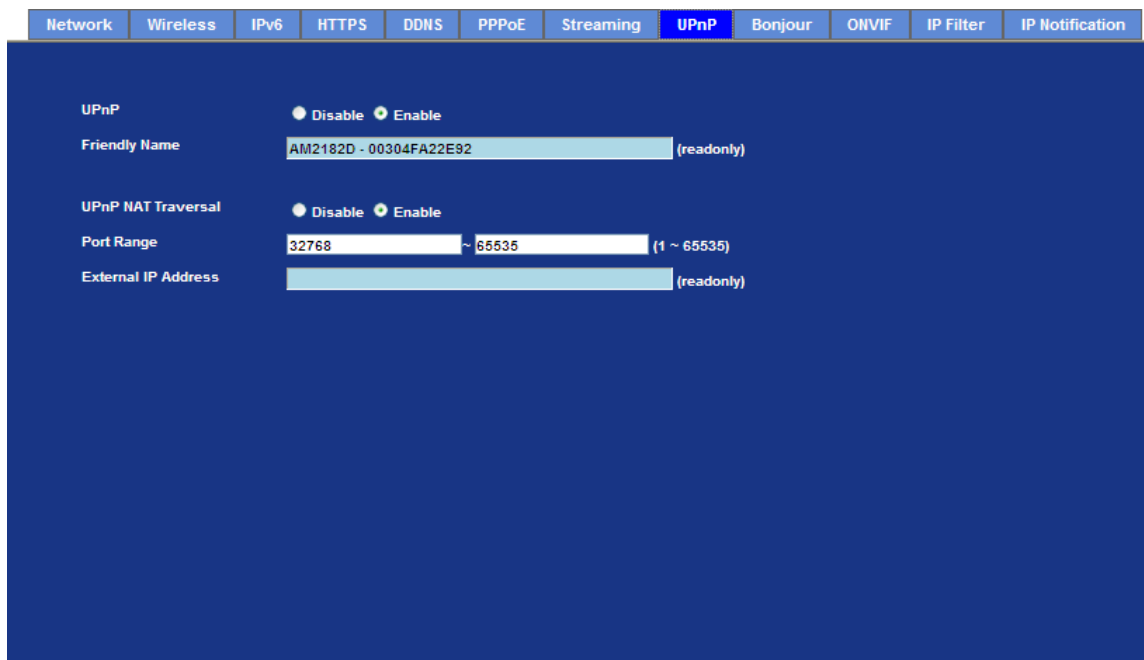

UPnP To enable or disable the UPnP service here.

Friendly Name Shows the friendly name of this device here.

UPnP NAT Traversal When enabled, the device will attempt to configure port mapping in a NAT router on your network, using UPnP™. Note that UPnP™

must be enabled in the NAT router first.

Port Range The port range will open in NAT router.

External IP address Show the IP address and port for WAN access through Internet. If NAT traversal is configured successfully, user can use this IP address and port to access this device.

3.5.9. Bonjour

The Bonjour service allows IP camera can be discovered with Apple Safari browser applied, once the option enable the IP camera will be show the Friendly Name in the Bonjour bookmarks menu of Safari browser.

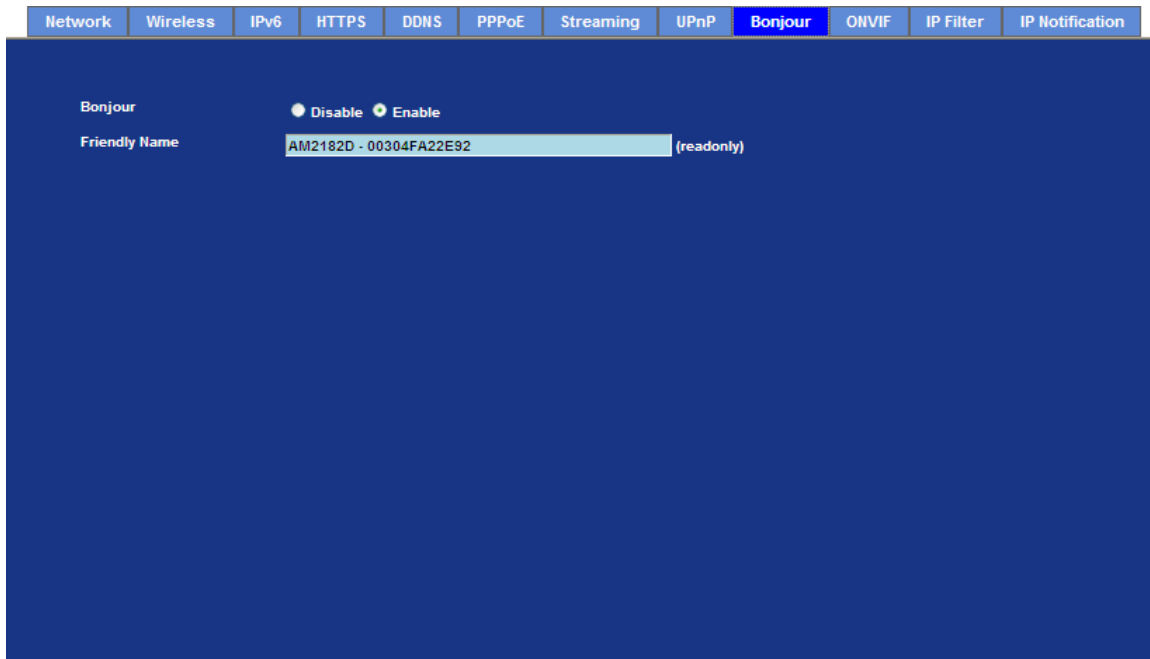

Bonjour To enable or disable the Bonjour service here.

Friendly Name Shows the friendly name of this device here.

3.5.10. ONVIF

ONVIF is a global and open industry forum with the goal to facilitate the development and use of a global open standard for the interface of physical IP-based security products. Or in other words, to create a standard for how IP products within video surveillance and other physical security areas can communicate with each other.

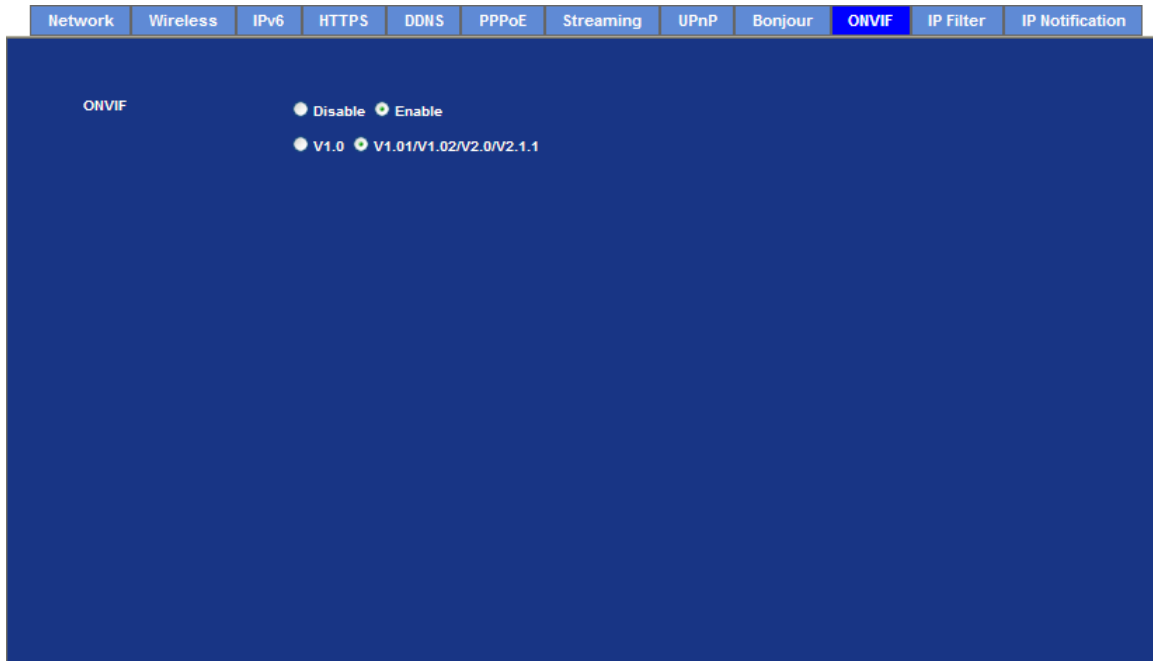

ONVIF

To enable or disable the ONVIF interface here.

Version

Currently, the V1.0 or V1.01/1.02/V2.0/V2.1.1 is available.

3.5.11. IP Filter

You can enter different user's IP address which are allowing enter or denying by the device.

The screenshot shows a web interface for configuring the IP Filter. At the top, there is a navigation bar with tabs for Network, Wireless, IPv6, HTTPS, DDNS, PPPoE, Streaming, UPnP, Bonjour, ONVIF, IP Filter (selected), and IP Notification. The main content area has a dark blue background. It contains the following elements:

- IP Filter:** A section with two radio buttons: Disable and Enable.
- IP Filter Policy:** A section with two radio buttons: Deny and Allow.
- Save:** A button to save the current configuration.
- Filter IP List:** A table with a header "Filter IP List" and a single row with a "Filter IP" label and an empty text input field.
- Buttons:** Below the table are three buttons: "Add", "Delete", and "DeleteAll".

IP Filter To enable or disable the IP filter function here.

IP Filter Policy Choose the filter policy where is denying or allowing.

3.5.12. IP Notification

In case the IP address is changed, system is able to send out an email to alert someone if the function is enabled.

SMTP Notification (e-mail)

If enable this function, then the “**Send to**” and “**Subject**” field need to be filled.

Send To

Type the receiver’s e-mail address. This address is used for reply mail.

Subject

Type the subject/title of the E-mail.

TCP Notification

If enable this function, then the “**TCP Server**”, “**TCP Port**”, and “**Message**” fields need to be filled.

TCP Server

Type the server name or the IP address of the TCP server.

TCP Port

Set port number of TCP server.

Message

The message will be sent to FTP server.

HTTP Notification

If enable this function, then the fields below need to be filled.

URL

Type the server name or the IP address of the HTTP server

HTTP Login name

Type the user name for the HTTP server.

HTTP Login Password	Type the password for the HTTP server.
Proxy Address	Type the server name or the IP address of the HTTP Proxy.
Proxy Port	Set port number of Proxy.
Proxy Login name	Type the user name for the HTTP Proxy.
Proxy Login Password	Type the password for the HTTP Proxy.
Custom parameter	User can set specific parameters to HTTP server.
Message	The message will be sent to HTTP server.

3.6 Camera Configuration

Use this menu to set the function of the camera of Internet Camera

3.6.1. Picture

Picture
Privacy Mask

Rotation	Normal	
White Balance	Auto	
Exposure Control	Auto Exposure	
Maximum Exposure Time	1/15 S	
Power Frequency	<input type="radio"/> 50Hz <input checked="" type="radio"/> 60Hz	
Color Level	<input type="range" value="50"/>	50 (0 ~ 100)
Brightness	<input type="range" value="50"/>	50 (0 ~ 100)
Contrast	<input type="range" value="50"/>	50 (0 ~ 100)
Sharpness	<input type="range" value="50"/>	50 (0 ~ 100)
White-Light LED	On	
<input type="range" value="4717"/>		
Current Value 4717 Refresh		
LED On Threshold 2000 (0 ~ 10000)		
LED Off Threshold 4000 (0 ~ 10000)		
Delay Time 10 (0 ~ 86400)		



Rotation

Turn the “Mirror” and “Vertical Flip” On or OFF. The image will be overturned as below.

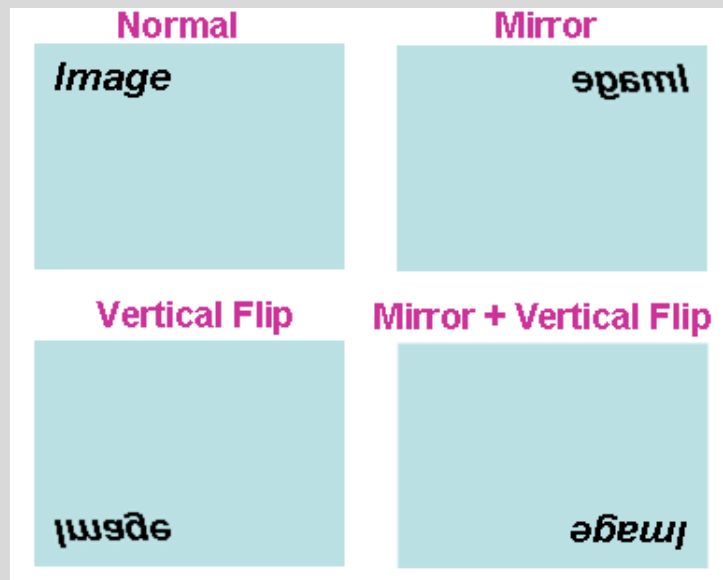

White Balance

Auto: will adjust the white balance automatically.

Hold: will hold the white balance.

Exposure Control	Auto: will adjust the internal gain automatically. Hold: will hold the internal gain.
Maximum Exposure Time	User can limit the maximum exposure time of the image sensor. The larger value means longer exposure time possibly.
Color Level	Large value will be colorful.
Brightness	Large value will brighten camera.
Sharpness	Large value will sharpen camera.
Contrast	Large value will contrast camera heavily.
White-Light LED	<p>User can turn On, Off, Auto or Schedule of the built-in White-light LEDs. This function is very useful under low illumination environment even 0 Lux.</p> <p>In case the Auto mode is selected, user needs to specify 3 parameters in advance:</p> <p>LED ON Threshold (0~10000): this value set the threshold to turn on white-light LED. It should be lower or equal to LED OFF Threshold.</p> <p>LED OFF Threshold (0~10000): this value set the threshold to turn off white-light LED. It should be higher or equal to LED ON Threshold.</p> <p>Delay Time: The delay time between LED ON/OFF switching.</p> <p>Note that Current Value is the current luminance from the captured video. It's a useful reference to set LED ON/OFF Threshold.</p>
3D De-Noise	3D De-Noise can remove or lower unwanted noise and preserve fine details and edges.
Default Settings	Restore to factory image settings.

3.6.2. Privacy Mask

Use this page to specify privacy mask window 1 to window 8 and set the name and gray level for selected window.

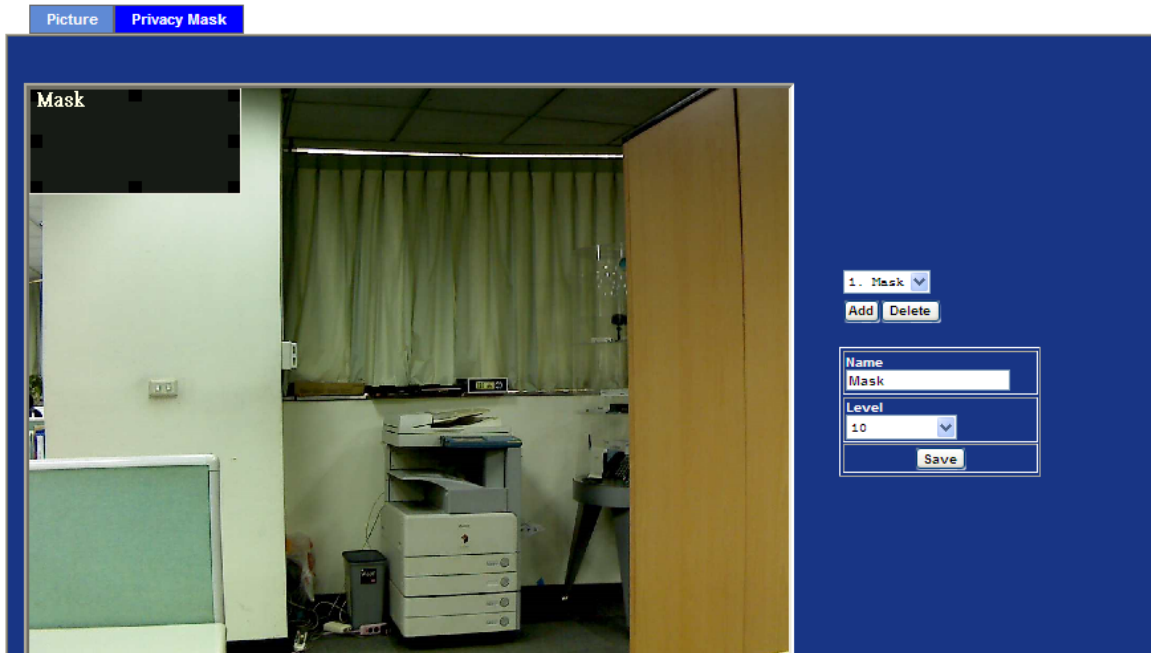

Add and Delete

To add or delete the privacy mask windows, user can specify up to 7 windows to mask the video captured by this device. By dragging mouse on the image, you can change the position and size of the selected window accordingly.

Name

Name of the specified privacy window

Level

To define the gray level of mask block. The smaller value will be darker.

3.7 System

Use this menu to perform the principal settings of Internet Camera.

3.7.1. System

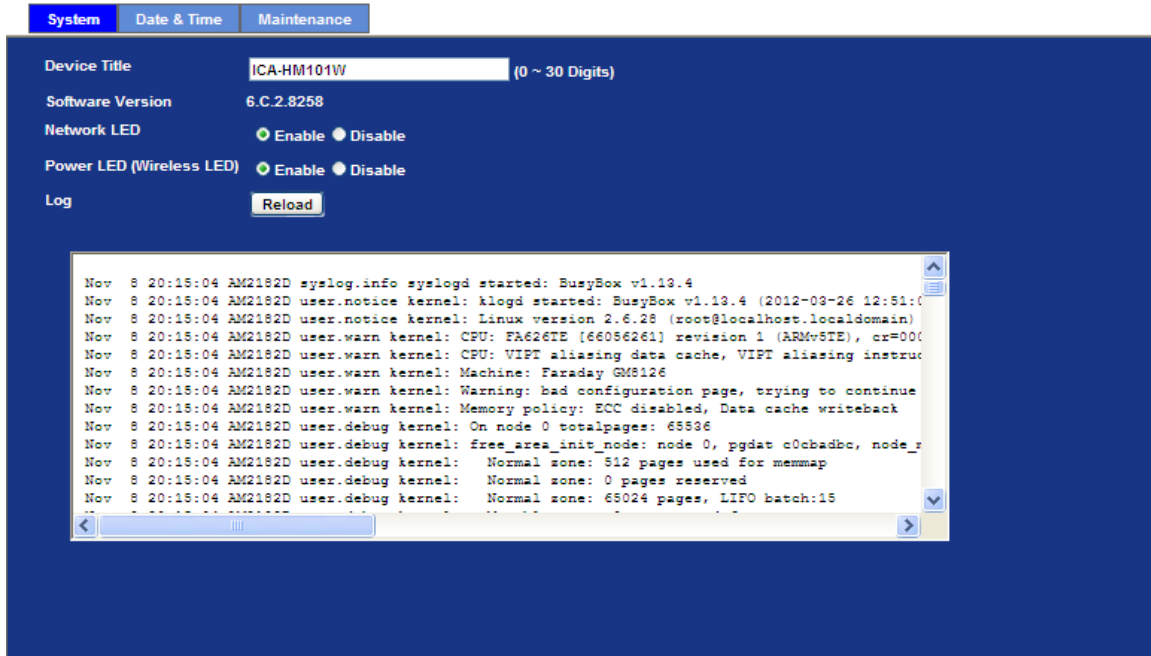

Device title You can enter the name of this unit here. It's very useful to identify the specific device from multiple units.

Software version This information shows the software version in the device.

Network LED Switch the LED light of this Internet Camera on or off, that Network LEDs will stop working, in case you don't want other people know the camera is transferring data.

Power LED Switch the LED light of this Internet Camera on or off.

Log User can check the system log information of the device, including the Main Info, Appended Info, Operator IP, and so on ...

Reload Click this button; user can refresh the log information of the device.

3.7.2. Date & Time

User can setup the time setting of Internet Camera, make it synchronized with PC or remote NTP server. Also, you may select the correct time zone of your country.

Server Date & Time	Displays the date and time of the device	
PC Time	Displays the date and time of the connected PC	
Adjust	Synchronize with PC:	Click this option to enable time synchronization with PC time
	Manual setting:	Click this option to set time and date manually
	Synchronize with NTP:	Click this option if you want to synchronize the device's date and time with those of time server called NTP server (Network Time Protocol)
NTP server name	Type the host name or IP address or domain name of the NTP server.	
NTP sync. Interval	Select an interval between 1 and 23 hours at which you want to adjust the device's time referring to NTP server	
Time zone	Set the time difference from Greenwich Mean Time in the area where the device is installed.	
Daylight saving	Check this item to enable daylight saving adjustment.	
Daylight Saving Start Time	Sets up the date and time of daylight saving start time.	

Daylight Saving Stop Time Sets up the date and time of daylight saving stop time.

Daylight Saving Offset Sets up the date of daylight saving offset.

3.7.3. Maintenance

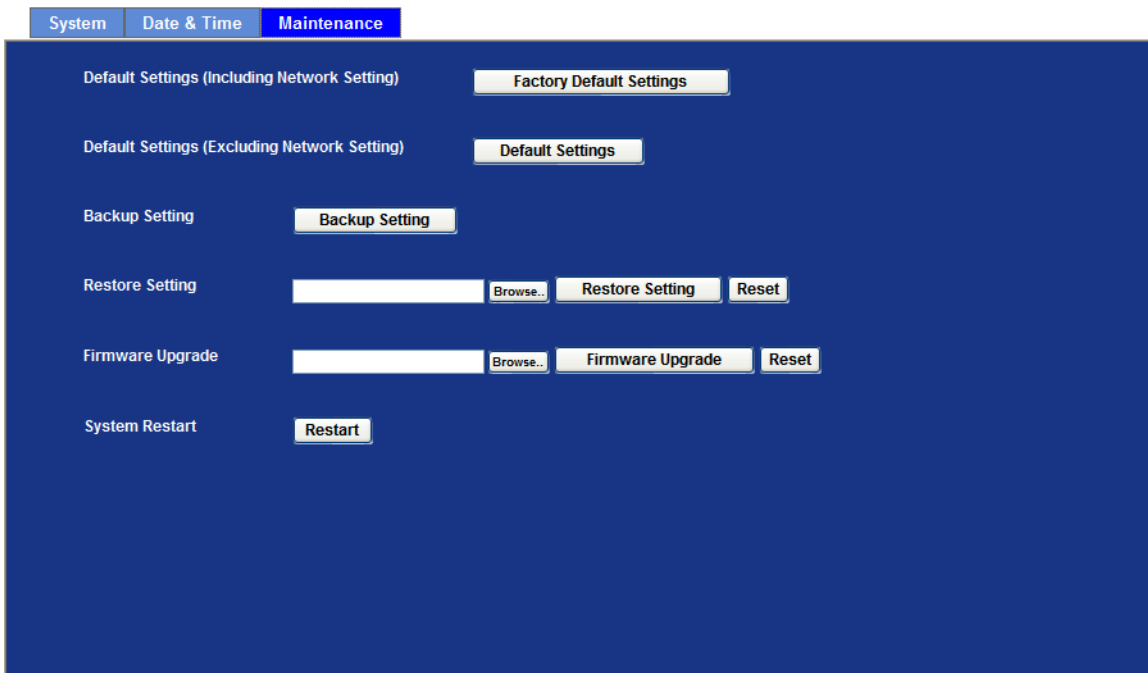

Default Settings (Include the network setting) Recall the device hard factory default settings. Note that click this button will reset all device's parameters to the factory settings (including the IP address).

Default Settings (Except the network setting) The unit is restarted and most current settings are reset to factory default values. This action will not reset the network setting.

Backup Setting To take a backup of all of the parameters, click this button. If necessary, it will then be possible to return to the previous settings, if settings are changed and there is unexpected behavior.

Restore Setting Click the "**Browse**" button to locate the saved backup file and then click the "Restore Setting" button. The settings will be restored to the previous configuration.

Firmware upgrade The device supports new firmware upgrade.

1. Close all other application programs which are not necessary for firmware update.

2. Make sure that only you access this device at this moment
3. Disable Motion Detection function.
4. Select “**Firmware name**”
5. Select the Firmware binary file.

Note :

That it must make sure that the Firmware only applies to this device, once update, it will be burned into FLASH ROM of system.

6. Once the firmware file was selected, select “**Upgrade**”.
7. The upgrade progress information will be displayed on the screen.
8. A message will be shown while the firmware upgraded. Once the upgrading process completed, the device will reboot the system automatically.
9. Please wait for 80 seconds, and then you can use PLANET IPWizard to search the device again.

Warning !!!

The download firmware procedure cannot be interrupted. If the power and/or network connection are broken during the download procedure, it might possibly cause serious damage to the device.

Please be aware that you should not turn off the power during updating the firmware and wait for finish message.

Furthermore, do not try to upgrade new firmware if it's not necessary.

System Restart

The device is restarted without changing any of the settings.

3.8 Video

This device provides 2 modes of video profile. The first one is Mega-pixel mode which supports video resolution up to Mega-pixel. However the maximum frame rate of this mode is up to 15fps only. The second one is VGA mode which supports video resolution up to VGA but frame rate can be up to 30fps. User only can select either Mega-pixel or VGA mode to operate the camera. Switching Mega-pixel and VGA, the device will take time to reboot system.

3.8.1. Common

The screenshot shows a configuration interface with three tabs: 'Common', 'Video Profile', and 'ROI'. The 'Common' tab is active. Under 'Video Profile', there are two radio buttons: '720p Mode' (unselected) and '2 Mega Mode' (selected). Under 'Text Overlay Setting', there are several options: 'Font Color' is set to '797979' with 'Set Color' and 'Default Color' buttons; 'Background Color' is set to '101010' with 'Set Color' and 'Default Color' buttons; 'Transparency' is set to '0 (opacity)' with a dropdown arrow; 'Include Date' is checked, with 'Predefined' selected and 'YYYY-MM-DD' in the dropdown, and 'Own' selected with the format '%Y-%m-%d' and '(0 ~ 12 Digits)'; 'Include Time' is checked, with 'Predefined' selected and '24h' in the dropdown, and 'Own' selected with the format '%H:%M:%S' and '(0 ~ 12 Digits)'; 'Include Text' is checked, with 'General Text' in the dropdown and an empty text field with '(0 ~ 20 Digits)' below it.

Video Profile

User can only choose either VGA Multi-profile or Mega Multi-profile mode. VGA Multi-profile mode can serve H.264, MPEG4, and JPEG streams up to VGA resolution simultaneously. On the other hand, Mega-pixel mode, in addition to VGA resolution, it can serve H.264/Mega and JPEG/Mega two more streams simultaneously.

Text Overlay Setting

There are some important information can be embedded into image, including date, time, and/or text.

3.8.2. Video Profile

User can modify the detail parameter for each video profiles in this page.

Name	Video Type	Resolution	Rate Control	Quality	Bitrate	Max Frame Rate	GOP Control	ROI
Profile1	h264	1600x1200	EVBR	75	-	15	30	no
Profile2	h264	1600x1200	EVBR	90	-	15	30	no
Profile3	mjpeg	1600x1200	VBR	75	-	3	1	no
Profile4 (ROI)	h264	640x480	EVBR	75	-	15	30	yes
Profile5 (ROI)	h264	640x480	EVBR	90	-	15	30	yes
Profile6	h264	640x480	EVBR	70	-	15	30	no
Profile7	h264	640x480	EVBR	80	-	15	30	no
Profile8	h264	640x480	EVBR	90	-	15	30	no
Profile9	mpeg4	640x480	EVBR	90	-	15	30	no
Profile10	mjpeg	640x480	VBR	90	-	3	1	no

Name	Profile1
Video Type	h264
Resolution	1600x1200
ROI	<input checked="" type="radio"/> Yes <input type="radio"/> No
Rate Control	EVBR Quality 75 Max Bitrate 8000 K bps 1024 ~ 15000
Max Frame Rate	15
GOP Control	30

Name To assign a name to the selected profile.

Video Type Video codec of the selected profile.

Resolution Resolution of the selected profile.

ROI Assign the selected profile as a ROI stream or not. (Only available for the profiles with max resolution)

Rate Control Defines the rate control method of this profile. There are four options: Constant Bit Rate (CBR), Variable Bit Rate (VBR), Enhanced Constant Bit Rate (ECBR), and Enhanced Variable Bit Rate (EVBR).

For CBR, the video bit rate is between low to high bandwidth based on different resolutions. User can set the desired bit rate to match the limitation of bandwidth.

For VBR, user should choose the quality level to set the video quality rather than bit rate. The quality level is between 1 and 100. The higher value can reach the better quality but of course will consume higher bandwidth.

For ECBR, the video bitrates is based on normal CBR mode. However, the target bitrates can be increased to max target bitrate while lots of motion in video. The max target bitrates will keep a pre-defined time period and then back to normal CBR bitrates.

For EVBR, the video bitrates is based on normal VBR mode. However, the target bitrates can be increased to max target bitrates while lots of motion in video. The max target bitrates will keep a pre-defined time period and then back to normal VBR mode.

Max Frame Rate Defines the targeted frame rate of this profile. For example, set the frame rate to 15 fps, then the image will be updated for 15 frames per second. User can set the desired max frame rate versus video quality under the limited bandwidth.

GOP Control Defines the Intra/Inter-frame (I/P) ratio of this profile. For example, set the GOP to 30, then the video stream will have one Intra-frame every 30 frames.

3.8.3. ROI

ROI means Region of Interest. Use this page to specify location of ROI windows. Only the maximum resolution profiles can be defined as ROI. In this model, the default ROI windows are profile 4 and 5.

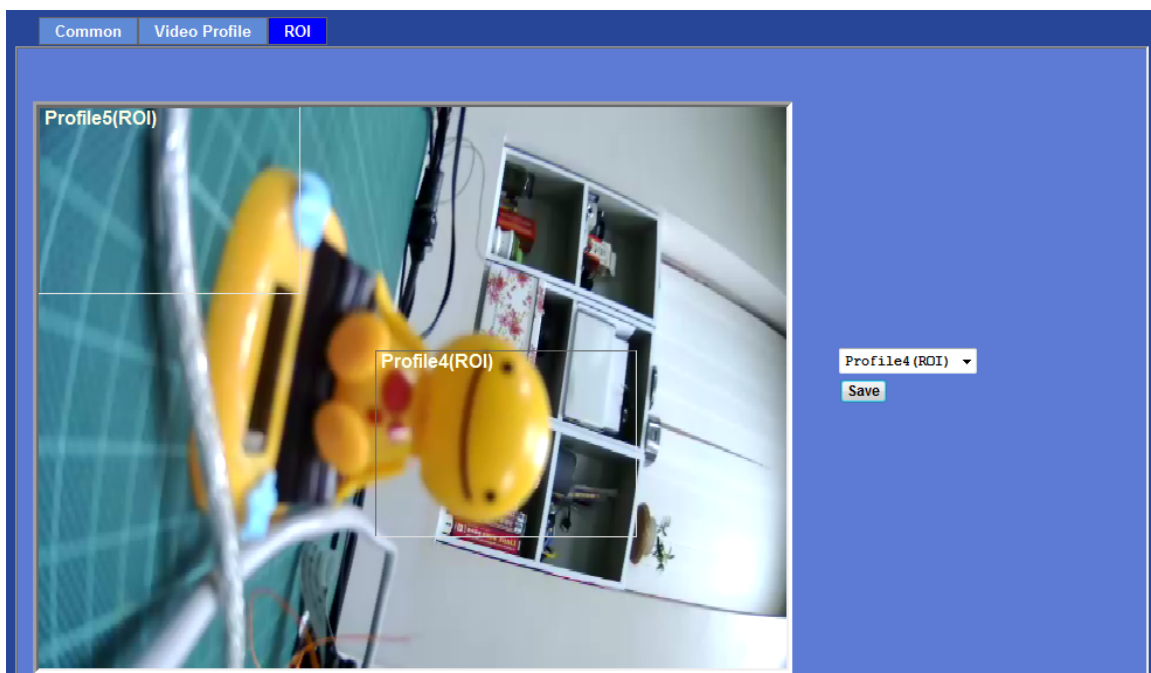

3.9 Audio Configuration

It's M-JPEG mode in this profile.

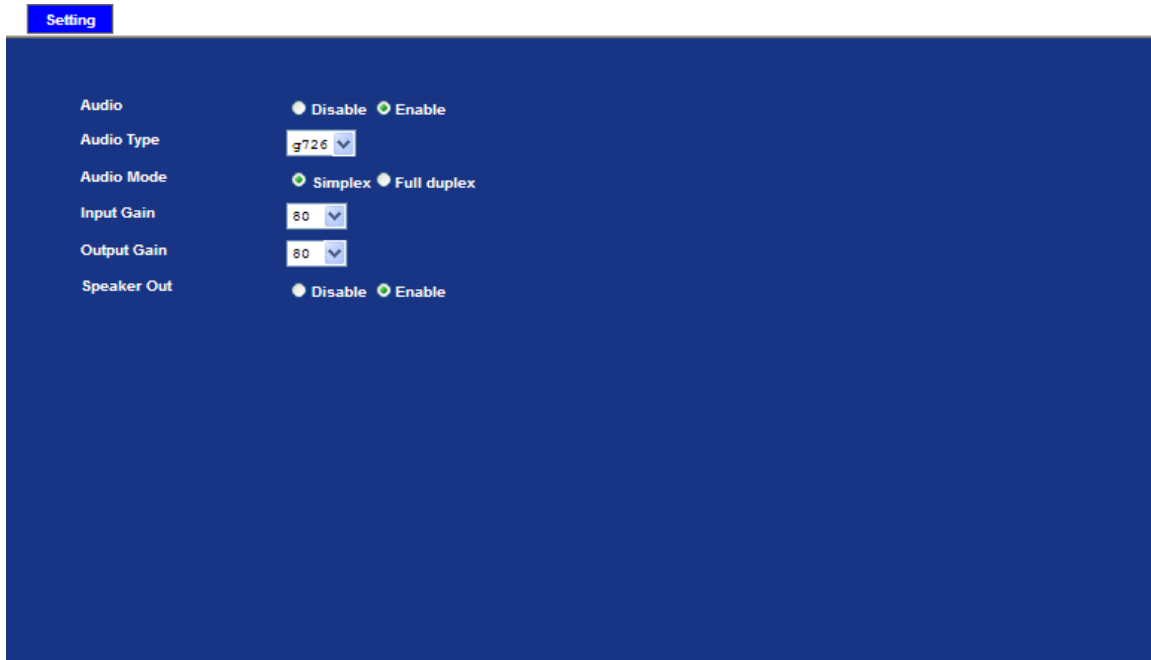

Audio	To enable or disable audio function.
Audio type	To select G711 or G726 for audio coding.
Audio Mode:	To select Simplex or Full duplex (2-way audio) mode.
Input Gain:	To adjust gain of input audio.
Output Gain:	To adjust gain of output audio.
Speaker Our	To enable or disable speaker function.

3.10 User Privilege Access Configuration

Use this menu to set the user names and password of the Administrator and up to 10 users, and access right of each user.

Setting

Viewer Login Anonymous Only users in database

User Name	Access Right
admin	administrator

User List	
User Name	<input type="text"/> (1 ~ 20 Digits)
Password	<input type="text"/> (0 ~ 20 Digits)
Verify Password	<input type="text"/> (0 ~ 20 Digits)
Access Right	<input type="radio"/> Administrator <input checked="" type="radio"/> Viewer
<input type="button" value="Add"/> <input type="button" value="Modify"/> <input type="button" value="Delete"/>	

Viewer Login

Select "Anonymous" to allow any one viewing the video once connected. Otherwise, only users in database can view the video after login.

Access Right

Administrator can access every function in this device. However, Viewers only can view the video and access limited function.

Add, Modify, and Delete of Users account

Manage the user's account of viewer user.

3.11 E-Mail Configuration

You may setup SMTP mail parameters for further operation of Event Schedule. That's, if users want to send the alarm message out, it will need to configure parameters here and also add at least one event schedule to enable event triggering.



The screenshot shows the following configuration details:

Field	Value	Constraint
SMTP Server	mail.planet.com.tw	(< 129 Digits)
SMTP Port	25	(1 ~ 65535)
SSL	<input type="radio"/> Disable <input checked="" type="radio"/> Enable	
SMTP Authentication	<input type="radio"/> Disable <input checked="" type="radio"/> Enable	
Authentication User Name	admin	(< 65 Digits)
Authentication Password	*****	(< 22 Digits)
E-mail From	admin@planet.com.tw	(< 129 Digits)
E-mail To	support@planet.com.tw	(< 129 Digits)
E-mail Subject	message	(< 65 Digits)

SMTP Server	Type the SMTP server name or the IP address of the SMTP server.
Test	Send a test mail to mail server to check this account is available or not.
SMTP Port	Set port number of SMTP service.
SSL	Enable SSL function or not.
SMTP Authentication	Select the authentication required when you send an e-mail. Disable: If no authentication is required when an e-mail is send. Enable: If authentication is required when an e-mail is sent.
Authentication User Name	Type the user name for the SMTP server if Authentication is Enable.
Authentication Password	Type the password for the SMTP server if Authentication is Enable.
E-mail From	Type the sender's E-mail address. This address is used for reply e-mails.
E-mail To	Type the receiver's e-mail address.
E-mail Subject	Type the subject/title of the e-mail.

3.12 Object Detection

Use this menu to specify motion detection window 1 to window 4 and set the conditions for detection while observing a captured image.

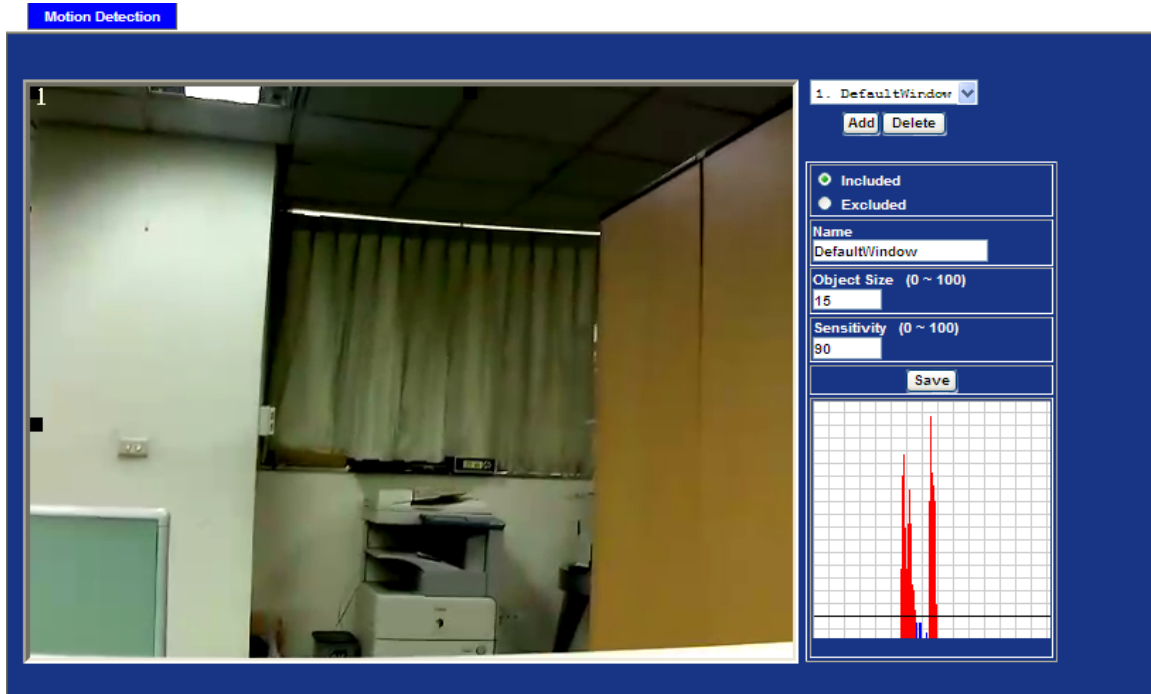

Add and Delete

To add or delete the motion windows. User can specify up to 4 Included and/or Excluded windows to monitor the video captured by this device. By dragging mouse on the image, you can change the position and size of the selected motion window accordingly.

Included or Excluded Window

These windows can be specified as Included or Excluded type.

Included:

Windows target specific areas within the whole video image

Excluded:

Windows define areas within an Include window that should be ignored (areas outside Include windows are automatically ignored)

Name

Name of the specified motion window.

Object Size

Defines the object size of motion detection. The higher object size will only larger objects trigger motion detection. The lower object size will even small objects trigger motion detection too. Generally speaking, the smaller size will be easier to trigger event.

Sensitivity

Defines the sensitivity value of motion detection. The higher value will be more sensitivity.

3.13 Storage Configuration

This page shows the status of attached SD card and Samba server. You may setup related parameters to manage the attached SD card or Samba server also.

The screenshot shows the 'SD Card' configuration page. At the top, there are two tabs: 'SD Card' (selected) and 'SAMB A Server'. The main content area is dark blue. It displays the following information and controls:

- Disk ID:** A text input field containing 'SD_DISK', with 'Mount' and 'Unmount' buttons to its right.
- Status:** A section containing several rows:
 - Free space:** A text input field showing '57% - 1126844KB', with 'Reload' and 'Format' buttons to its right.
 - Total size:** A text input field showing '1966080 KB'.
 - Status:** A text input field showing 'OK'.
 - Full:** A text input field showing 'No'.
 - Readonly:** A text input field showing 'No'.
- Enable automatic disk cleanup:** A checkbox that is currently unchecked.
- Remove recordings older than:** A text input field showing '7' followed by '(day(s))'.
- Remove oldest recordings when disk is:** A text input field showing '95' followed by '% full'.
- Lock disk:** A checkbox that is currently unchecked.

The screenshot shows the 'SAMB A Server' configuration page. At the top, there are two tabs: 'SD Card' and 'SAMB A Server' (selected). The main content area is dark blue. It displays the following information and controls:

- Host:** A text input field containing '192.168.0.201' with '(1 ~ 63 Digits)' to its right.
- Share:** A text input field containing 'share' with '(1 ~ 63 Digits)' to its right.
- User Name:** A text input field containing 'test' with '< 63 Digits)' to its right.
- Password:** A text input field containing '*****' with '< 63 Digits)' to its right.
- Status:** A text input field showing 'Online'.
- Total size:** A text input field showing '13.34 GB'.
- Free space:** A text input field showing '59% - 7.88 GB'.
- SAMB A Server:** A text input field containing 'Unmount' with a button to its right.

Enable automatic disk cleanup Delete old recorded files while the conditions are reached as below.

Remove recordings order than Delete old files by days.

Remove oldest recordings when disk is Delete old files by left capacity.

3.14 Recording List

This page shows the files list information, files list inside the SD Card. User may reload file from SD card that play or remove the selected file.

Recording List Continuous Recording List

Date	File	Trigger by	Size
20120329	20120326_113301.avi	motion0Occur	2004 KB
20120330	20120326_115716.avi	motion0Occur	2068 KB
20120326	20120326_115732.avi	motion0Occur	2081 KB
	20120326_115740.avi	motion0Occur	2067 KB
	20120326_115749.avi	motion0Occur	2093 KB
	20120326_115755.avi	motion0Occur	2059 KB
	20120326_115932.avi	motion0Occur	2057 KB
	20120326_115943.avi	motion0Occur	2056 KB
	20120326_115951.avi	motion0Occur	2090 KB
	20120326_121234.avi	motion0Occur	2074 KB
	20120326_121329.avi	motion0Occur	2067 KB
	20120326_121411.avi	motion0Occur	2056 KB

Reload Play Remove

This page shows the files list information, files list inside the SD Card or Samba server. User may reload file from SD card or Samba server that play or remove the selected file.

Recording List Continuous Recording List

Disk: SD Card
Path: PLANET-00304FA22E92

Date	File	Trigger by	Size
20120326	20120326_113156.avi	continuous	15506 KB
	20120326_113656.avi	continuous	17931 KB
	20120326_114156.avi	continuous	19834 KB
	20120326_114657.avi	continuous	19608 KB
	20120326_115157.avi	continuous	19150 KB
	20120326_115659.avi	continuous	50094 KB
	20120326_120200.avi	continuous	20253 KB
	20120326_120701.avi	continuous	19704 KB
	20120326_121201.avi	continuous	27162 KB

Reload Play Remove

3.15 Continuous Recording

You may enable or disable continuous recording function here. Select SD card or Samba server for storage destination.

Note : When enable continuous recording that press restart will delete correct recording

Continuous Recording

Continuous Recording Disable Enable

Record File Type

Disk SD Card SAMBA Server

Path (For example: Folder1/Folder2/Folder3) (1 ~ 63 Digits)

(Restarting will delete the current recording.)

3.16 Event Server Configuration

3.16.1 FTP Server

You may setup FTP parameters for further operation of Event Schedule. That's, if users want to send the alarm message to an FTP server, it will need to configure parameters here and also add at least one event schedule to enable event triggering as SMTP.

Name	FTP Server	FTP Port	FTP Path
FTP	192.168.0.174	21	/anthony/test

Name	FTP	(< 22 Digits)
FTP Server	192.168.0.174	(< 65 Digits) <input type="button" value="Test"/>
FTP Login Name	admin	(< 22 Digits)
FTP Login Password	*****	(< 22 Digits)
FTP Port	21	(1 ~ 65535)
FTP Path	/admin/test	(< 65 Digits)
FTP Passive Mode	<input type="radio"/> Disable <input checked="" type="radio"/> Enable	

Name	User can specify multiple FTP paths as wish. Therefore, user needs to specify a name for each FTP setting.
FTP Server	Type the server name or the IP address of the FTP server.
Test	Check the FTP server whether this account is available or not.
FTP Login name	Type the user name for the FTP server.
FTP Login Password	Type the password for the FTP server.
FTP Port	Set port number of FTP service.
FTP Path	Set working directory path of FTP server.
FTP Passive Mode	Select passive or active mode connecting to FTP server.

3.16.2 TCP Server

In addition to send video file to FTP server, the device also can send event message to specified TCP server.

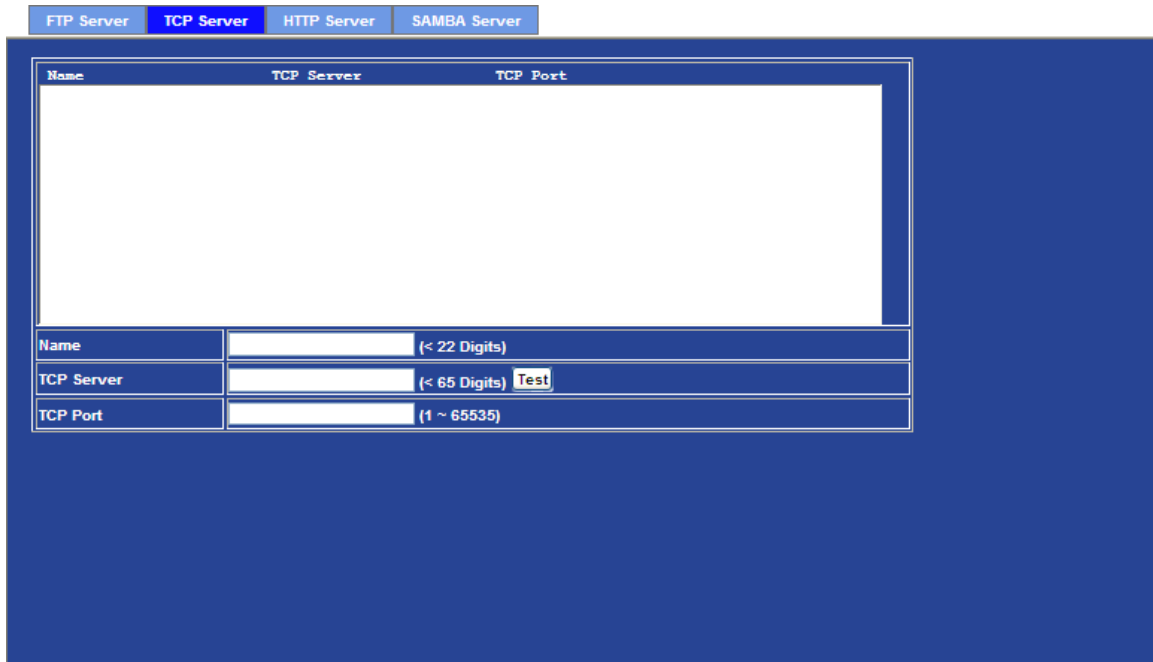

Name	TCP Server	TCP Port
------	------------	----------

Name	<input type="text"/>	(< 22 Digits)
TCP Server	<input type="text"/> <input type="button" value="Test"/>	(< 65 Digits)
TCP Port	<input type="text"/>	(1 ~ 65535)

Name	User can specify multiple TCP servers as wish. Therefore, user needs to specify a name for each TCP server setting.
-------------	---

TCP Server	Type the server name or the IP address of the TCP server.
-------------------	---

TCP Port	Set port number of TCP server.
-----------------	--------------------------------

3.16.3 HTTP Server

The device also can send event message to specified HTTP server.

Name	User can specify multiple HTTP servers as wish. Therefore, user needs to specify a name for each HTTP server setting.
URL	Type the server name or the IP address of the HTTP server.
Test	Check the HTTP server whether it is available or not.
HTTP Login name	Type the user name for the HTTP server.
HTTP Login Password	Type the password for the HTTP server.
Proxy Address	Type the server name or the IP address of the HTTP Proxy.
Proxy Login name	Type the user name for the HTTP Proxy.
Proxy Login Password	Type the password for the HTTP Proxy.
Proxy Port	Set port number of Proxy.

3.16.4 SAMBA Server

The device also can send video stream to specified SAMBA server. Most of the time, the SAMBA server will be another PC or NAS server.

Name	SAMBA Server	SAMBA Path
samba	192.168.0.201	share

Name	samba	(< 22 Digits)
SAMBA Server	192.168.0.201	(< 65 Digits) Test
SAMBA Login Name	test	(< 22 Digits)
SAMBA Login Password	*****	(< 22 Digits)
SAMBA Path	share	(< 65 Digits)

Name User can specify multiple HTTP servers as wish. Therefore, user needs to specify a name for each HTTP server setting.

SAMBA Server Type the server name or the IP address of the SAMBA server.

Test Check the SAMBA server whether this account is available or not.

SAMBA Login name Type the user name for the SAMBA server.

SAMBA Login Password Type the password for the SAMBA server.

SAMBA Path Set working directory path of SAMBA server.

3.17 Event Schedule Configuration

This menu is used to specify the schedule of Events and activate the some actions provided by this device.

Name	Enable	Type	Weekday	Start	Duration	Trigger by	Prefix	Action
Event1	yes	Event	1111111	0:0	24:0	x,x,1		IR

- Name** Name of the Event or Schedule.
- Enable** Enable or disable this Event or Schedule.
- Type** Schedule start with Event trigger or Schedule trigger.
- Enable Time** Define the feasible time slot.
- Trigger by** Select the triggered sources with event trigger.
- Record File Prefix** Define the prefix of recorded filename
- Action** Define the actions once event triggered.

Example1.

The screenshot shows a web interface with three tabs: 'Setting', 'Record', and 'Port Status'. The 'Setting' tab is active. At the top, there is a table with columns: Name, Enable, Type, Weekday, Start, Duration, Trigger by Prefix, and Action. The table contains one entry: 'Send to FTP' with 'yes' for Enable, 'Event' for Type, '1111111' for Weekday, '0:0' for Start, '24:0' for Duration, 'x,M0,1' for Trigger by Prefix, and 'FTP,IR' for Action.

Below the table is a configuration form for the 'Send to FTP' trigger. The form fields are:

- Name: Send to FTP
- Enable: Yes No
- Type: Event Trigger Schedule Trigger, Interval 60 (Seconds)
- Enable Time: Sun Mon Tue Wed Thu Fri Sat. Start from 0:0, Duration 24:0 (max 168:00 hours)
- Trigger by: Sensor Change to active, Motion Area DefaultWindow, PIR Change to active
- Record File Prefix: (0 ~ 20 Digits)
- Action: Voice Alert, Duration (0-86400 Seconds), Alarm Out, Duration (0-86400 Seconds), Send FTP FTP, Send TCP, Send HTTP, Send E-Mail, White-Light LED Night Mode 30 (0-86400 Seconds), Send SD

Send file to FTP server by motion triggered always:

1. Select event trigger
2. Enable time: start from 00:00 to 24:00 every day
3. Trigger by: Motion Area (Added in Object Detection page)
4. Action : Send FTP (Add in Event Server -> FTP Server page)

Example2.

The screenshot shows a web interface with three tabs: 'Setting', 'Record', and 'Port Status'. The 'Setting' tab is active. At the top, there is a table with columns: Name, Enable, Type, Weekday, Start, Duration, Trigger by, Prefix, and Action. One row is visible: 'Send to FTP' with 'yes' for Enable, 'Event' for Type, '1111111' for Weekday, '0:0' for Start, '24:0' for Duration, 'x,MO,1' for Trigger by, and 'FTP,IR' for Action.

Below the table is a form for configuring the 'Send to E-mail' event trigger. The fields are as follows:

- Name: Send to E-mail
- Enable: Yes No
- Type: Event Trigger Schedule Trigger, Interval 60 (Seconds)
- Enable Time: Sun Mon Tue Wed Thu Fri Sat. Start from 0:0, Duration 24:0 ((max 168:00 hours))
- Trigger by: Sensor Change to active Motion Area DefaultWindow PIR Change to active
- Record File Prefix: (0 ~ 20 Digits)
- Action: Voice Alert, Duration (0~86400 Seconds) Alarm Out, Duration (0~86400 Seconds) Send FTP FTP Send TCP Send HTTP Send E-Mail. To email address support@planet.com.tw, Subject Motion Detected!

Send file to E-Mail server by motion triggered from Friday 18:00 to Saturday 06:00

1. Select event trigger.
2. Enable time: start from Friday 18:00 and keep work in 12 hours, so it will stop on Saturday 06:00.
3. Trigger by : Motion Area (Added in Object Detection page)
4. Action : Send e-mail (Add in E-Mail page)
 - i. To email address: You need to input the receiver email address.
 - ii. Subject: You could specify the email subject.
 - iii. Message: You could specify the email content.

Example3.

Setting							
Name	Enable	Type	Weekday	Start	Duration	Trigger by Prefix	Action
Trigger_Voice_A...	yes	Schedule	0111110	18:0	12:0	x,x,x	VOICE,IR

Name	Trigger_Voice_Aalert
Enable	<input checked="" type="radio"/> Yes <input type="radio"/> No
Type	<input type="radio"/> Event Trigger <input checked="" type="radio"/> Schedule Trigger, Interval 600 (Seconds)
Enable Time	<input type="checkbox"/> Sun <input checked="" type="checkbox"/> Mon <input checked="" type="checkbox"/> Tue <input checked="" type="checkbox"/> Wed <input checked="" type="checkbox"/> Thu <input checked="" type="checkbox"/> Fri <input type="checkbox"/> Sat Start from 18:00, Duration 12:00 (max 168:00 hours)
Trigger by	<input type="checkbox"/> Sensor Change to active <input type="checkbox"/> Motion Area <input type="checkbox"/> PIR Change to active
Record File Prefix	(0 ~ 20 Digits)
Action	<input checked="" type="checkbox"/> Voice Alert, Duration 10 (0~86400 Seconds) <input type="checkbox"/> Alarm Out, Duration (0~86400 Seconds) <input type="checkbox"/> Send FTP <input type="checkbox"/> Send TCP <input type="checkbox"/> Send HTTP <input type="checkbox"/> Send E-Mail <input checked="" type="checkbox"/> White-Light LED Night Mode 30 (0~86400 Seconds) <input type="checkbox"/> Send SD

Enable Voice Alert every 10-minute during 18:00 to 24:00 from Monday to Friday.

1. Type: Select schedule trigger and interval is 10-minute.
2. Enable Time: Select Monday to Friday, and set start time from 18:00 and keep work in 6 hours.
3. Trigger by: You do not need to choose it, because this will be triggered every minute.
4. Action: Voice Alert.

3.18 Record Configuration

User can choose the type of record file for event or schedule application.

The screenshot shows a configuration interface with a dark blue background. At the top, there are three tabs: 'Setting', 'Record', and 'Port Status'. The 'Record' tab is selected. Below the tabs, there are five configuration items, each with a label and a corresponding input field:

- Record File Type:** A dropdown menu showing 'Profile1 h264 / 1600x1200'.
- Record File Prefix:** A text input field with '(0 ~ 20 Digits)' to its right.
- Pre Trigger Duration:** A text input field containing '5' with '(0 ~ 20 Seconds)' to its right.
- Best Effort Duration:** A text input field containing '30' with '(1 ~ 60 Seconds)' to its right.
- Max File Size:** A text input field containing '2048' with '(256 ~ 3072 Bytes)' to its right.

Record File Type Choose AVI or JPEG file format for record file.

Record File Prefix Define the prefix of recorded filename.

Pre-Trigger Duration Define the maximum duration of pre-alarm.

Best Effort Duration Define the best effort duration of post-alarm.

Max File Size Define the maximum buffer size of record file.

Appendix A: PING IP Address

The PING (stands for Packet Internet Groper) command is used to detect whether a specific IP address is accessible by sending a packet to the specific address and waiting for a reply. It's also a very useful tool to confirm Internet Camera installed or if the IP address conflicts with any other devices over the network.

If you want to make sure the IP address of Internet Camera, utilize the PING command as follows:

- Start a DOS window.
- Type ping x.x.x.x, where x.x.x.x is the IP address of the Internet Camera.

The replies, as illustrated below, will provide an explanation to the problem.

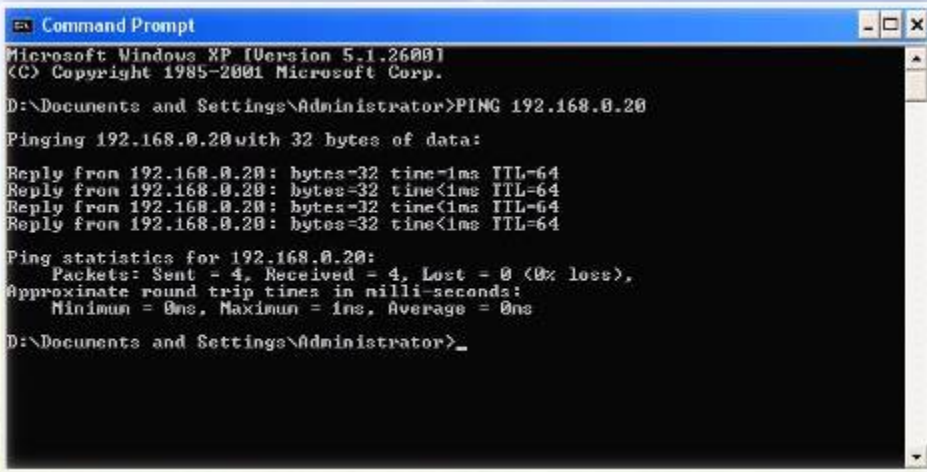

```
Command Prompt
Microsoft Windows XP [Version 5.1.2600]
(C) Copyright 1985-2001 Microsoft Corp.

D:\Documents and Settings\Administrator>PING 192.168.0.20
Pinging 192.168.0.20 with 32 bytes of data:
Reply from 192.168.0.20: bytes=32 time=1ms TTL=64
Reply from 192.168.0.20: bytes=32 time<1ms TTL=64
Reply from 192.168.0.20: bytes=32 time<1ms TTL=64
Reply from 192.168.0.20: bytes=32 time<1ms TTL=64

Ping statistics for 192.168.0.20:
    Packets: Sent = 4, Received = 4, Lost = 0 (0% loss),
    Approximate round trip times in milli-seconds:
        Minimum = 0ms, Maximum = 1ms, Average = 0ms

D:\Documents and Settings\Administrator>_
```

If you want to detect any other devices conflicts with the IP address of Internet Camera, also can utilize the PING command but you must disconnect the Internet Camera from the network first.

Appendix B: 3GPP Access

To use the 3GPP function, in addition to previous section, you might need more information or configuration to make this function work.

Note *That to use the 3GPP function, it strongly recommends to install the Networked Device with a public and fixed IP address without any firewall protection.*

RTSP Port:

Port 554 is the default for RTSP service. However, sometimes, some service providers change this port number for some reasons. If so, user needs to change this port accordingly.

Dialing procedure:

1. Choose a verified player (PacketVideo or Realplayer currently)
2. Use the following URL to access:

rtsp://host/mpeg4/media.3gp

Where *host* is the host name or IP address of the camera.

Compatible 3G mobile phone:

Please contact your dealer to get the approved list of compatible 3G phone.

Note *Besides IP camera and 3G mobile phone. You will also need to make sure the ISP and telephone company has provided the 3GPP service to you.*

Appendix C: Bandwidth and Video Size Estimation

The frame rate of video transmitted from the Internet Camera depends on connection bandwidth between client and server, video resolution, codec type, and quality setting of server. Here is a guideline to help you roughly estimate the bandwidth requirements for your Internet Camera.

The required bandwidth depends on content of video source. The slow motion video will produce smaller bit rate generally and fast motion will produce higher bit rate vice versa. Actual results generated by the Internet Camera may be varying.

Image Resolution	Average range of data sizes for M-JPEG mode	Average bit rate for MPEG-4 mode	Average bit rate for H.264 mode
160 x 120 (QQVGA)	3 ~ 6k byte per frame	64kbps~256kbps @ 30fps	32kbps~192kbps @ 30fps
320 x 240 (QVGA)	8 ~ 20k byte per frame	256kbps~768kbps @ 30fps	192kbps~512kbps @ 30fps
640 x 480 (VGA)	20 ~ 50K byte per frame	512kbps~2048kbps @ 30fps	384kbps~1536kbps @ 30fps
1280x1024 (SXGA)	100 ~ 200k byte per frame	NA	512kbps~3076kbps @ 15fps

NOTE: Audio streaming also takes bandwidth around 5 kbps to 64kbps. Most xDSL/Cable modem upload speeds may not even reach up to 128 kbps. Thus, you may not be able to receive any video while streaming audio on a 128 kbps or lower connection. Even though the upload speed is more than 128kbps, for optimal video performance, disabling audio streaming will get better video performance.

Appendix D: DDNS Application

1. Preface

If you have a Cable modem or xDSL, this is a great way to host your own Networked Device or other TCP/IP Service. Get your own domain like www.yourname.com, www.yourname.com.tw etc. (Note: This domain must be registered with Internic via registration authorities such as Network Solutions, DirectNIC, Register.com etc). Your domain name's dynamic IP address is automatically tracked by a DDNS server.

Host your own Networked Device and much more no matter what your computer's IP address may be and even if you have dialup, DSL or cable modem internet connection where your computer's IP address changes all the time!! DDNS service supports all top level domain names including but not limited to .com, .net, .org, .to, .uk etc.

2. Ethernet Network Environment

Normally, DDNS service is only necessary for the users that could only obtain dynamic IP addresses. As to the users that could obtain the static valid IP address, they do not usually have to apply the DDNS service. Before we decide if DDNS is necessary for the users, we have to check what kind of Ethernet network environment we have to install our Networked Device on.

(1) Environment of Fixed Valid IP Network

If users could obtain valid IP addresses, they could save the effort to apply DDNS service. Because the IP address in this environment is fixed, users could input the IP address or domain name of demo site directly in the IE browser.

(2) Environment of Dynamic IP Network

If users is under an environment of dynamic IP network (Dial-up xDSL), they have to apply a domain name in advance. Then apply DDNS service. Finally setup the necessary information of DDNS and PPPoE of the Networked Device in order to let the outside administrator be able to access through internet.

3. Application Steps – DDNS & Domain Name

(1). Visit the following web site: <http://www.dyndns.org/>

(2). Click “Account”



(3). After the columns show up at the left side, click “Create Account”.

DynDNS

About Services Account

My Account
[Create Account](#)
[Login](#)
[Lost Password?](#)

Search DynDNS

Login

It is strongly recommended that you visit this page

Account Login

Username:

You must have cookies enabled

- (4). Fill the application agreement and necessary information.
- Username
 - E-mail address and confirmation
 - Password and confirmation
 - Submit all the input information and finish creating an account

DynDNS User: Pass:
[Lost Password?](#) - [Create Account](#)

About Services Account Support News

My Account
[Create Account](#)
[Login](#)
[Lost Password?](#)

Create Your DynDNS Account

Please complete the form to create your free DynDNS Account.

It is strongly recommended that you visit this page [securely](#). You are not currently visiting this page securely.

Search DynDNS

Personal Information

Username:

E-mail Address: Instructions: An activate your account will be sent to the e-mail address provided.

Confirm E-mail Address:

Password: Your password needs to be more than 5 characters and cannot be the same as your username.

Confirm Password: Choose a password that is a common word, or can otherwise be easily guessed.

Terms of Service

Please read the acceptable use policy (AUP) and accept it prior to creating your account. Also acknowledge that you may only have one (1) free account, and that creation of multiple free accounts will result in the deletion of all of your accounts.

Policy Last Modified: February 6, 2006

1. ACKNOWLEDGMENT AND ACCEPTANCE OF TERMS OF SERVICE

All services provided by Dynamic Network Services, Inc. ("DynDNS") are provided to you (the "Member") under the Terms and Conditions set forth in this Acceptable Use Policy ("AUP") and any other operating rules and policies set forth by DynDNS. The AUP comprises the entire agreement between the Member and DynDNS and supersedes all prior agreements between the parties regarding the subject matter contained herein. BY COMPLETING THE REGISTRATION PROCESS AND CLICKING THE "Accept" BUTTON, YOU ARE INDICATING YOUR AGREEMENT TO BE BOUND BY ALL OF THE TERMS AND CONDITIONS OF THE AUP.

2. DESCRIPTION OF SERVICE

I agree to the AUP:

I will only create one (1) free account:

Click these two options

Next Step

After you click "Create Account", we will create your account and send you an e-mail to the address you provided. Please follow the instructions in that e-mail to confirm your account. You will need to confirm your account within 48 hours or we will automatically delete your account. (This helps prevent unwanted robots on our systems)

Create Account

- Check your e-mail mailbox. There will be an e-mail with a title "Your DynDNS Account Information". Click the hyperlink address to confirm the DDNS service that you just applied. Then DDNS you applied activated.

Click to confirm

Your DynDNS Account 'kkkkk' has been created. You need to visit the confirmation address below within 48 hours to complete the account creation process:

https://www.dyndns.com/account/confirm/oDDGDYN75qTJk_ICGba6vQ

Our basic service offerings are free, but they are supported by our paid services. See <http://www.dyndns.com/services/> for a full listing of all of our available services.

If you did not sign up for this account, this will be the only communication you will receive. All non-confirmed accounts are automatically deleted after 48 hours, and no addresses are kept on file. We apologize for any inconvenience this correspondence may have caused, and we assure you that it was only sent at the request of someone visiting our site requesting an account.

Sincerely,
The DynDNS Team

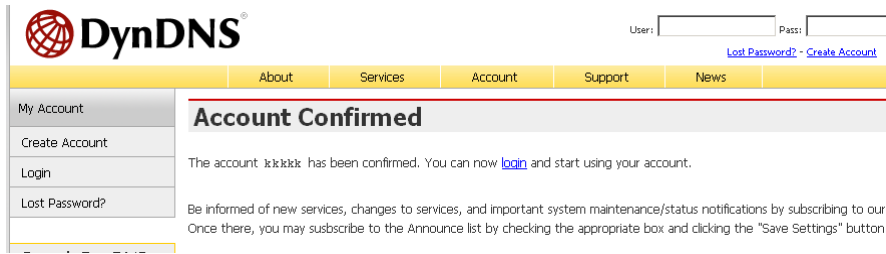

- (6). Enter the web page <http://www.dyndns.org/> again. Input your username and password that you just applied to login administration interface of DDNS server.



- (7). If the correct username and password are input, you can see the following picture at the top-right of the login page.

- (8). Click the "Services".



(9). Click the “Dynamic DNS”.

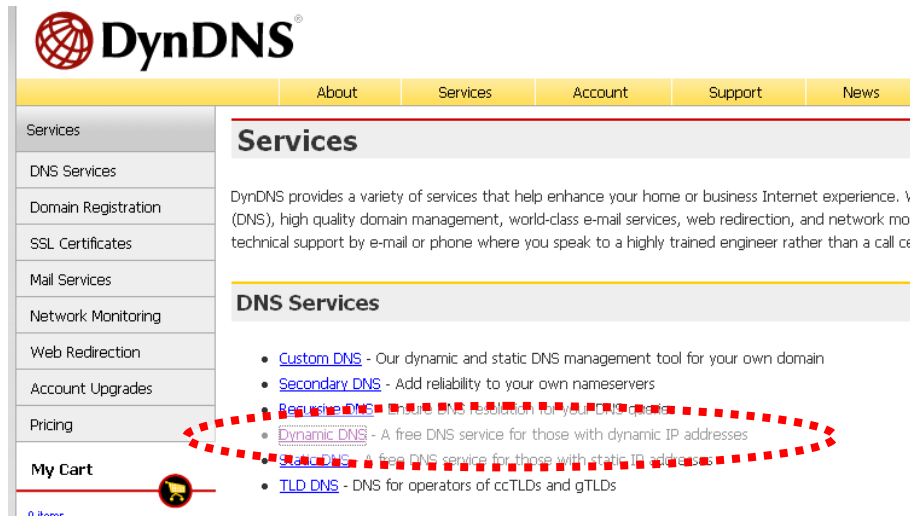

(10). Click the “Create Hosts”.

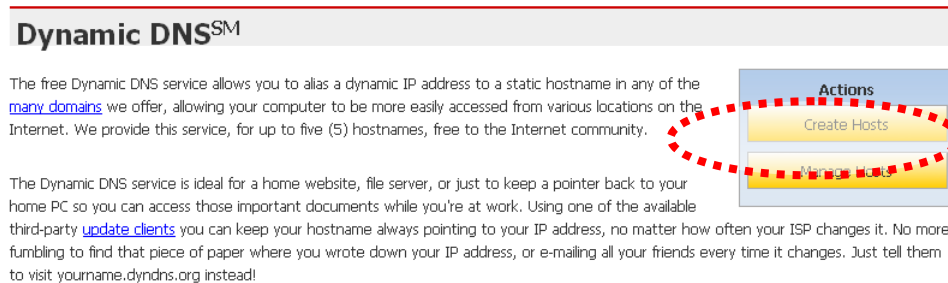

(11). We could create a domain name without any charge at this step. First, we input the host name. (No.1) Then we pick a domain that is easy to remember. Finally (No.2), click the “Add Host” to submit the domain name information. (No.3)

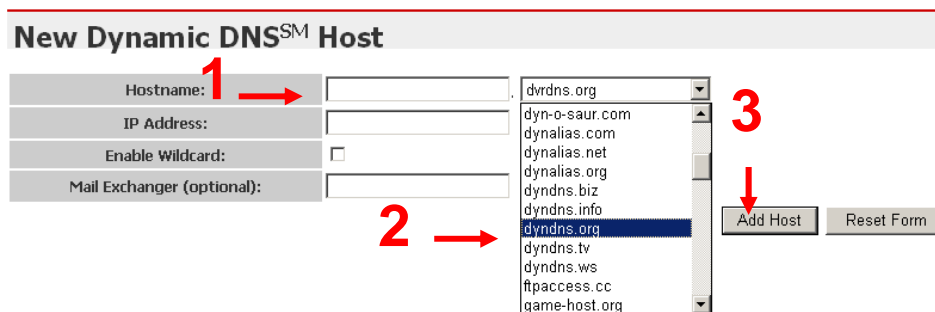

4. Setup the DDNS and PPPoE of network device

At last, users have to enter the web page of Networked Device and setup the necessary information of DDNS and PPPoE after the application of DDNS service. Please check the user manual to access the DDNS and PPPoE pages. After saving the modification, restart the device. The external users could browse the Networked Device by the input of their domain name.

5. Configure PLANET DDNS steps:

Step 1: Enable DDNS option through accessing web page of NAS

Step 2. Select on DDNS server provide, and register an account if you do not use yet.

Let's take dyndns.org as an example. Register an account in <http://planetddns.com>

The screenshot shows the PLANET DDNS website. At the top, there is a navigation bar with the PLANET logo (Network & Communication) on the right, and a home icon followed by 'PLANET DDNS' on the left. Below the navigation bar are links for 'PLANET Website', 'FAQ', and 'Support'. The main content area features a 'Sign in' form with fields for 'ID / Email' and a password field, a 'Sign in' button, and links for 'Forgotten Password / Create A New Account'. Below the sign-in form, there are three product cards: 1. 'XRT-401F Internet Broadband Router' with a 'More Info' button. 2. 'ICA-HM132 2 Mega-Pixel 20M IR Vari-Focal Dome IP Camera' with a 'More Info' button. 3. 'ICA-HM316 2 Mega-Pixel 11n Outdoor IR IP Camera' with a 'More Info' button. At the bottom, there is a dark grey section with two columns: 'Access anytime & anywhere' with a description and a 'Go!' button, and 'Support & Download' with a description. The footer contains the text 'About DDNS | Term of Usage' and 'PLANET Technology Corp. Copyright ©2012 All Rights Reserved.'

Appendix E:

Configure Port Forwarding Manually

The device can be used with a router. If the device wants to be accessed from the WAN, its IP address needs to be setup as fixed IP address, also the port forwarding or Virtual Server function of router needs to be setup. This device supports UPnP traversal function. Therefore, user could use this feature to configure port forwarding of NAT router first. However, if user needs to configure port forwarding manually, please follow the steps as below:

Manually installing the device with a router on your network is an easy 3–step procedure as following:

1. Assign a local/fixed IP address to your device
2. Access the Router with Your Web browser
3. Open/Configure Virtual Server Ports of Your Router

1. Assign a local/fixed IP address to your device

The device must be assigned a local and fixed IP Address that allows it to be recognized by the router. Manually setup the device with a fixed IP address, for example, *192.168.0.100*.

2. Access the Router with Your Web browser

The following steps generally apply to any router that you have on your network. The PLANET WNRT-620 is used as an example to clarify the configuration process. Configure the initial settings of the router by following the steps outlined in the router's **Quick Installation Guide**.

If you have cable or DSL service, you will most likely have a dynamically assigned WAN IP Address. 'Dynamic' means that your router's WAN IP address can change from time to time depending on your ISP. A dynamic WAN IP Address identifies your router on the public network and allows it to access the Internet. To find out what your router's WAN IP Address is, go to the **Status** screen on your router and locate the WAN information for your router. As shown on the following page the WAN IP Address will be listed. This will be the address that you will need to type in your web browser to view your camera over the Internet. Be sure to uncheck the **Reset IP address at next boot** button at the top of the screen after modifying the IP address. Failure to do so will reset the IP address when you restart your computer.

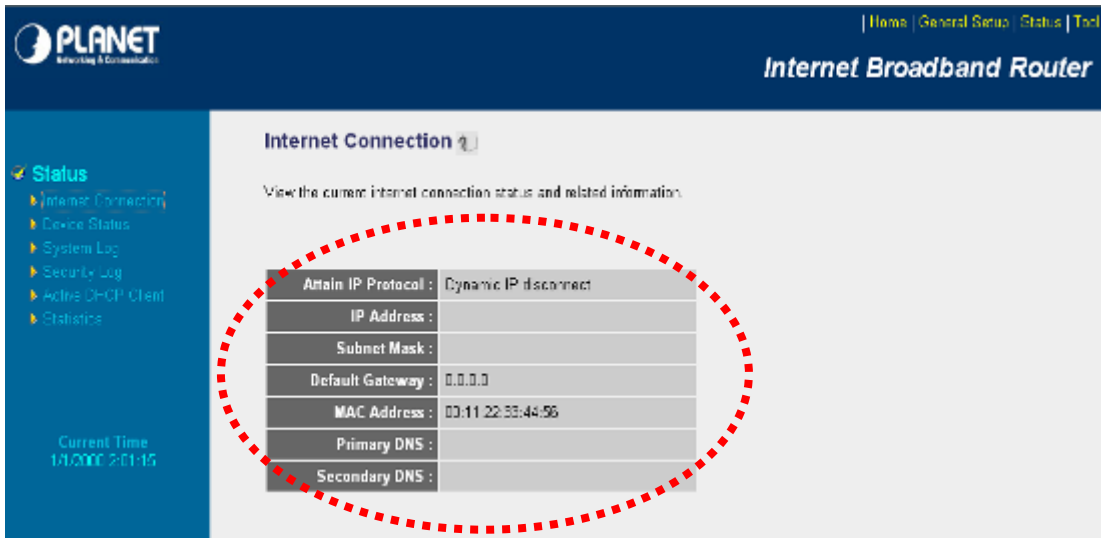

Your WAN IP Address will be listed here.

3. Open/set Virtual Server Ports to enable remote image viewing

The firewall security features built into the router and most routers prevent users from accessing the video from the device over the Internet. The router connects to the Internet over a series of numbered ports. The ports normally used by the device are blocked from access over the Internet. Therefore, these ports need to be made accessible over the Internet. This is accomplished using the **Virtual Server** function on the router. The Virtual Server ports used by the camera must be opened through the router for remote access to your camera.

Follow these steps to configure your router's Virtual Server settings

- Click **Enabled**.
- Enter a unique name for each entry.
- Select **Both** under **Protocol Type (TCP and UDP)**
- Enter your camera's local IP Address (e.g., **192.168.0.100**, for example) in the **Private IP** field.
- If you are using the default camera port settings, enter **80** into the **Public** and **Private Port** section, click **Add**.

A check mark appearing before the entry name will indicate that the ports are enabled.

NOTE Some ISPs block access to port 80. Be sure to check with your ISP so that you can open the appropriate ports accordingly. If your ISP does not pass traffic on port 80, you will need to change the port the camera uses from 80 to something else, such as 8080. Not all routers are the same, so refer to your user manual for specific instructions on how to open ports.

PLANET Networking & Communication | Home | General Setup | Status | Tool | Internet Broadband Router

Virtual Server ?

You can configure the Broadband router as a Virtual Server so that remote users accessing services such as the Web or FTP at your local site via Public IP Addresses can be automatically redirected to local servers configured with Private IP Addresses. In other words, depending on the requested service (TCP/UDP) port number, the Broadband router redirects the external service request to the appropriate internal server (located at one of your LAN's Private IP Address).

Enable Virtual Server

Private IP	Private Port	Type	Public Port	WAN Port	Comment
<input type="text"/>	<input type="text"/>	Both	<input type="text"/>	WAN1	<input type="text"/>

Add Reel

Current Virtual Server Table:

Private IP	Private Port	Type	Public Port	WAN Port	Comment	Select
192.168.0.100	80	TCP+UDP	80	WAN1	ICAHM200	<input type="checkbox"/>

Down Disabled Down All Down

Apply Cancel

Enter valid ports in the **Virtual Server** section of your router. Please make sure to check the box on this line to enable settings. Then the device can be access from WAN by the router's WAN IP Address.

By now, you have finished your entire PC configuration for this device.

Appendix F: Power Line Frequency

COUNTRY	VOLTAGE	FREQUENCY	COMMENTS
Argentina	220V	50 Hz	*Neutral and line wires are reversed from that used in Australia and elsewhere.
Australia	230V*	50 Hz	*Outlets typically controlled by adjacent switch. Though <i>nominal</i> voltage has been officially changed to 230V, 240V is within tolerances and commonly found.
Austria	230V	50 Hz	
Brazil	110/220V*	60 Hz	*127V found in states of Bahia, Paran (including Curitiba), Rio de Janeiro, Paulo and Minas Gerais (though 220V may be found in some hotels). Other areas are 220V only, with the exception of Fortaleza (240V).
Canada	120V	60 Hz	
China	220V	50 Hz	
Finland	230V	50 Hz	
France	230V	50 Hz	
Germany	230V	50 Hz	
Hong Kong	220V*	50 Hz	
India	230V	50 Hz	
Italy	230V	50 Hz	
Japan	100V	50/60 Hz*	*Eastern Japan 50 Hz (Tokyo, Kawasaki, Sapporo, Yokohama, and Sendai); Western Japan 60 Hz (Osaka, Kyoto, Nagoya, Hiroshima)
Malaysia	240V	50 Hz	
Netherlands	230V	50 Hz	
Portugal	230V	50 Hz	
Spain	230V	50 Hz	
Sweden	230V	50 Hz	
Switzerland	230V	50 Hz	
Taiwan	110V	60 Hz	
Thailand	220V	50 Hz	
United Kingdom	230V*	50 Hz	*Outlets typically controlled by adjacent switch. Though nominal voltage has been officially changed to 230V, 240V is within tolerances and commonly found.
United States of America	120V	60 Hz	

Appendix G: Troubleshooting & Frequently Asked Questions

Features	
The video and audio codec is adopted in the device.	<p>The device utilizes H.264, MPEG-4 and M-JPEG triple compression to providing high quality images. Where H.264 and MPEG-4 are standards for video compression and M-JPEG is a standard for image compression.</p> <p>The audio codec is defined as AMR for 3GPP and G.711/G.726 for RTSP streaming.</p>
The maximum number of user accesses the device simultaneously.	The maximum number of users is limited to 20. However, it also depends on the total bandwidth accessed to this device from clients. The maximum data throughput of the device is around 20~25Mbps for UDP mode and 10Mbps for HTTP mode. Therefore, the actual number of connected clients is varying by streaming mode, settings of resolution, codec type, frame rate and bandwidth. Obviously, the performance of the each connected client will slow down when many users are logged on.
The device can be used outdoors or not.	The device is not weatherproof. It needs to be equipped with a weatherproof case for outdoors using. However, equipped with a weatherproof case might disable the audio function of the device.
Install this device	
Status LED does not light up.	Check and confirm that the DC power adaptor, included in packaged, is used. Secure the power connector and re-power it on again.
The network cabling is required for the device.	The device uses Category 5 UTP cable allowing 10 and/or 100 Base-TX networking.
The device will be installed and work if a firewall exists on the network.	If a firewall exists on the network, port 80 is open for ordinary data communication. The HTTP port and RTSP port need to be opened on the firewall or NAT router.
The username and password for the first time or after factory default reset	<p>Username = admin and leave password blank.</p> <p>Note that it's all case sensitivity.</p>
Forgot the username and password	<p>Follow the steps below.</p> <ol style="list-style-type: none"> 1. Restore the factory default setting by press pressing and holding down more than 3 seconds on the device. 2. Reconfigure the device.
Forgot the IP address of the device.	Check IP address of device by using the PLANET IPWizard program or by UPnP discovery or set the device to default by Reset button.

<p>PLANET IP Wizard II program cannot find the device.</p>	<ul style="list-style-type: none"> ● Re-power the device if cannot find the unit within 1 minutes. ● Do not connect device over a router. PLANET IP Wizard II program cannot detect device over a router. ● If IP address is not assigned to the PC which running PLANET IP Wizard II program, then PLANET IP Wizard II program cannot find device. Make sure that IP address is assigned to the PC properly. ● Antivirus software on the PC might interfere with the setup program. Disable the firewall of the antivirus software during setting up this device. ● Check the firewall setting of your PC or Notebook.
<p>Internet Explorer does not seem to work well with the device</p>	<p>Make sure that your Internet Explorer is version 6.0 or later. If you are experiencing problems, try upgrading to the latest version of Microsoft's Internet Explorer from the Microsoft webpage.</p>
<p>PLANET IP Wizard II program fails to save the network parameters.</p>	<p>Network may have trouble. Confirm the parameters and connections of the device.</p>
<p>UPnP NAT Traversal</p>	
<p>Can not work with NAT router</p>	<p>Maybe NAT router does not support UPnP function. Please check user's manual of router and turn on UPnP function.</p>
<p>Some IP cameras are working but others are failed</p>	<p>Maybe too many IP cameras have been installed on the LAN, and then NAT router is out of resource to support more cameras. You could turn off and on NAT router to clear out of date information inside router.</p>
<p>Access this device</p>	
<p>Cannot access the login page and other web pages of the Internet Camera from Internet Explorer</p>	<ul style="list-style-type: none"> ● Maybe the IP Address of the Internet Camera is already being used by another device or computer. To confirm this possible problem, disconnect the Internet Camera from the network first, and then run the PING utility to check it out. ● Maybe due to the network cable. Try correcting your network cable and configuration. Test the network interface by connecting a local computer to the Internet Camera via a crossover cable. ● Make sure the Internet connection and setting is ok. ● Make sure enter the IP address of Internet Explorer is correct. If the Internet Camera has a dynamic address, it may have changed since you last checked it. ● Network congestion may prevent the web page appearing quickly. Wait for a while. <p>The IP address and Subnet Mask of the PC and Internet Camera must be in the same class of the private IP address on the LAN.</p> <ul style="list-style-type: none"> ● Make sure the http port used by the Internet Camera, default=80, is forward to the Internet Camera's private IP address.

	<ul style="list-style-type: none"> • The port number assigned in your Internet Camera might not be available via Internet. Check your ISP for available port. • The proxy server may prevent you from connecting directly to the Internet Camera, set up not to use the proxy server. • Confirm that Default Gateway address is correct. • The router needs Port Forwarding feature. Refer to your router's manual for details. • Packet Filtering of the router may prohibit access from an external network. Refer to your router's manual for details. • Access the Internet Camera from the Internet with the global IP address of the router and port number of Internet Camera. • Some routers reject the global IP address to access the Internet Camera on the same LAN. Access with the private IP address and correct port number of Internet Camera. • When you use DDNS, you need to set Default Gateway and DNS server address. • If it's not working after above procedure, reset Internet Camera to default setting and installed it again.
<p>Image or video does not appear in the main page.</p>	<ul style="list-style-type: none"> • The first time the PC connects to Internet Camera, a pop-up Security Warning window will appear to download ActiveX Controls. When using Windows XP, or Vista, log on with an appropriate account that is authorized to install applications. • Network congestion may prevent the Image screen from appearing quickly. You may choose lower resolution to reduce the required bandwidth.
<p>How to check the device's ActiveX is installed on your computer</p>	<p>Go to C:\Windows\Downloaded Program Files and check to see if there is an entry for the file "IPCamera Control". The status column should show "Installed". If the file is not listed, make sure your Security Settings in Internet Explorer are configured properly and then try reloading the device's home page. Most likely, the ActiveX control did not download and install correctly. Check your Internet Explorer security settings and then close and restart Internet Explorer. Try to browse and log in again.</p>
<p>Internet Explorer displays the following message: "Your current security settings prohibit downloading ActiveX controls".</p>	<p>Setup the IE security settings or configure the individual settings to allow downloading and scripting of ActiveX controls.</p>
<p>The device work locally but not externally.</p>	<ul style="list-style-type: none"> • Might be caused from the firewall protection. Check the Internet firewall with your system or network administrator. The firewall may need to have some settings changed in order for the device to be accessible outside your LAN. • Make sure that the device isn't conflicting with any other web server running on your LAN. • Check the configuration of the router settings allow the device to

	<p>be accessed outside your local LAN.</p> <ul style="list-style-type: none"> ● Check the bandwidth of Internet connection. If the Internet bandwidth is lower than target bit rate, the video streaming will not work correctly.
The unreadable characters are displayed.	Use the operating system of the selected language. Set the Encoding or the Character Set of the selected language on the Internet Explorer.
Frame rate is slower than the setting.	<ul style="list-style-type: none"> ● The traffic of the network and the object of the image affect the frame rate. The network congestion causes frame rate slower than the setting. ● Check the bandwidth of Internet connection. If the Internet bandwidth is lower than target bit rate, the video streaming will not work correctly. ● Ethernet switching hub can smooth the frame rate.
Blank screen or very slow video when audio is enabled.	<ul style="list-style-type: none"> ● Your connection to the device does not have enough bandwidth to support a higher frame rate for the streamed image size. Try reducing the video streaming size to 160x120 or 320x240 and/or disabling audio. ● Audio will consume 32 kbps. Disable audio to improve video. Your Internet connection may not have enough bandwidth to support streaming audio from the device.
Image Transfer on e-mail or FTP does not work.	<ul style="list-style-type: none"> ● Default Gateway and DNS server address should be set up correctly. ● If FTP does not work properly, ask your ISP or network administrator about the transferring mode of FTP server.
Pan/Tilt does not work. (including Click to Center and Preset Positioning)	<ul style="list-style-type: none"> ● Click "Refresh" on the Internet Explorer when the communication stops with the device. The image will refresh. ● Other clients may be operating Pan/Tilt. ● Pan/Tilt operation has reached the end of corner.
Pan/Tilt does not work smoothly.	There may be a slight delay when you are using the Pan/Tilt feature in conjunction with streaming audio and video. If you find that there is a significant delay while panning or tilting the camera, try disabling the audio streaming and/or reducing the video streaming size.
Video quality of the device	
The focus on the Camera is bad.	The lens is dirty or dust is attached. Fingerprints, dust, stain, etc. on the lens can degrade the image quality.
The color of the image is poor or strange.	<ul style="list-style-type: none"> ● Adjust White Balance. ● To insure the images you are viewing are the best they can be, set the Display property setting (color quality) to 16bit at least and

	<p>24 bit or higher if possible within your computer.</p> <ul style="list-style-type: none"> • The configuration on the device image display is incorrect. You need to adjust the image related parameters such as brightness, contrast, hue and sharpness properly.
Image flickers.	<ul style="list-style-type: none"> • Wrong power line frequency makes images flicker. Make sure the 50 or 60Hz format of your device. • If the object is dark, the image will flicker. Make the condition around the Camera brighter.
Noisy images occur.	<p>The video images might be noisy if the device is located in a very low light environment. Make the condition around the camera brighter or turn the White-light LED on.</p>
Miscellaneous	
Can not play the recorded ASF file	<p>Please installed Microsoft®'s DirectX 9.0 or later and uses the Windows Media Player 11.0 or later to play the AVI filed recorded by the Device.</p>

Appendix H: Product Specification

Product	ICA-HM101	ICA-HM101W
Camera		
Image Sensor	1/3" 2 Mega-Pixel CMOS image sensor	
Lens	4.3 mm, F1.8	
View Angle (Horizontal / Vertical)	56 / 43 Degree	
Effective Pixels	1600x1200 (UXGA)	
Min Illumination	0.5 lux @ F1.2	
Signal to Noise	42 dB	
LED	12 x White-light LED	
Indication LED	Green and orange LEDs	
PIR Sensor	Built-in. 6m/120° coverage	
Motion Detection	10 area definable	
Min Illumination	0.5 lux @ F1.2	
Video		
Video Encoder	H.264 / MPEG-4 / M-JPEG	
Video Profile	20 profiles simultaneously	
Video Resolution	H.264 UXGA / VGA / QVGA / QQVGA MPEG4 VGA / QVGA / QQVGA M-JPEG UXGA / VGA / QVGA / QQVGA	
Rate Control	CBR (Constant Bit Rate) / VBR (Variable Bit Rate)	
Frame Rate	Mega-Pixel mode up to 15fps for all resolution VGA mode up to 30fps for VGA / QVGA / QQVGA	
Image Setting	AE, AWB 3D Noise reduction Digital WDR Color, brightness, sharpness, contrast, Hue Mirror/Flip Privacy Masks Text, time and date overlay	
Streaming	Simultaneously multi-profile streaming Streaming over UDP, TCP, or HTTP M-JPEG streaming over HTTP (server push) Supports 3GPP mobile surveillance (MPEG4) Controllable frame rate and bandwidth Constant and variable bit rate (MPEG4 / H.264) ROI	
Audio		
Audio Codec	RTSP: G.711 64kbps, G.726 32kbps 3GPP: AMR	
Audio Streaming	One-way or two-way	
Audio I/O	Audio in: Internal Microphone and Speaker / Audio out: Line	
Network and Configuration		
Network Interface	10/100M auto negotiation	

Network Standard	IEEE 802.3 / IEEE 802.3u	IEEE 802.3 / IEEE 802.3u / IEEE 802.11 b/g/n
Security	--	WEP and WPA encryption
Network Protocol	TCP/IP, UDP, HTTP, SMTP, FTP, NTP, DNS, DDNS, DHCP, ARP, Bonjour, UPnP, RTSP, RTP, RTCP, PPPoE, 3GPP, ICMP	
Browser / Software	Microsoft ® Internet Explorer 6.0 or later, Cam Viewer Three Lite/Pro	
Users	20 simultaneous unicast users	
Connection type	Static IP, DHCP	
Management	Web, CV3P, CV3L	
System Integration		
SDK	Open API for software integration ONVIF	
Alarm Triggers	Intelligent video motion detection, external input, PIR detector (Human detect)	
Alarm Events	File upload via FTP, SAMBA, SD card or email Notification via email, HTTP, and TCP External output activation Audio alerting output	
Video Buffer	Pre- and post- alarm buffering	
Environment Specifications		
Power Requirement	12V DC, 1A IEEE 802.3af	12V DC, 1A
Dimension (H x W x D)	91x61x39 mm	
Weight	150g	
Power Consumption	7W (12VDC)	
Operating Temperature	-10 ~ 40 Degree C	
Operating Humidity	20 ~ 80% (non-condensing)	
Emission	CE, FCC	