

## Quick Installation Guide

WNAP-6335

300Mbps 802.11n Wireless Outdoor CPE



### 1. Package Contents

Thank you for choosing PLANET WNAP-6335. Before installing the AP, please verify the contents inside the package box.

WNAP-6335



Quick Guide



PoE Injector & Power Cord



Plastic Strap x 1



Note

If there is any item missing or damaged, please contact the seller immediately.

- 1 -

### 3. Physical Introduction

#### Rear Panel Description – LED Indication

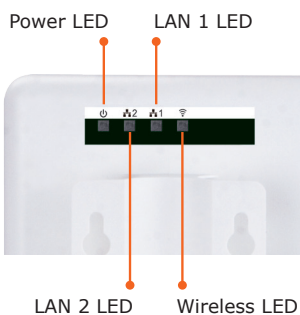

#### Bottom Panel Description – Port

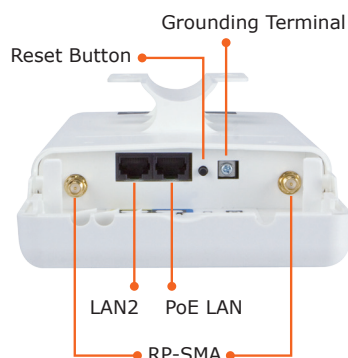

- 3 -

## 2. Installation Precautions

### IMPORTANT SAFETY PRECAUTIONS:

- 1) **LIVES MAY BE AT RISK!** Please be aware of the electrical wires around, and tighten the pole. Carefully read the section "**OUTDOOR INSTALLATION WARNING**" in the manual before installation.
- 2) Users **MUST** use the "**PoE Injector**" and "**Power Cord**" shipped in the box with the WNAP-6335. Otherwise, the product might be damaged.
- 3) Users **MUST** use a proper and well-installed surge arrester and grounding wired with the WNAP-6335; otherwise, a sudden lightning could cause fatal damage to the WNAP-6335. **EMD (Lightning) DAMAGE IS NOT COVERED UNDER WARRANTY.**
- 4) Users **MUST** have the antenna connected first before powering on the WNAP-6335; otherwise, damage to the WNAP-6335 might happen.
- 5) The Antenna is required, and must be purchased separately.



Caution

- 2 -

### 4. Hardware Installation

**STEP 1:** (A) Push the latch on the bottom of the WNAP-6335 to remove the sliding cover.

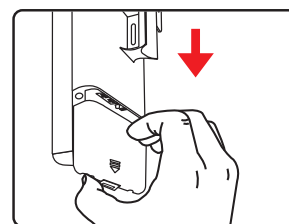
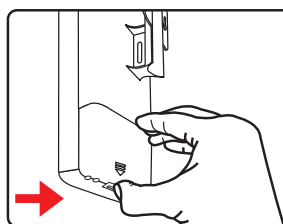

(B) Plug the RJ45 Ethernet cable into the PoE LAN Port and connect the external antenna to the RP-SMA connectors of the WNAP-6335. Then, slide back the cover of the WNAP-6335 to finish the installation.

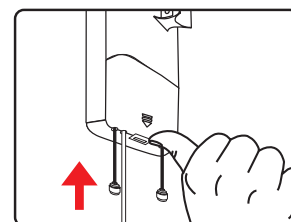
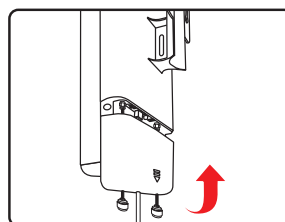

RP-SMA(Male) to N-male Cable

- 4 -

**STEP 2:** Plug the power cord into the DC port and the other side into the AC socket. Then, plug the RJ45 cable (as shown in picture 4 under Step 1) into the POE port of the PoE injector.

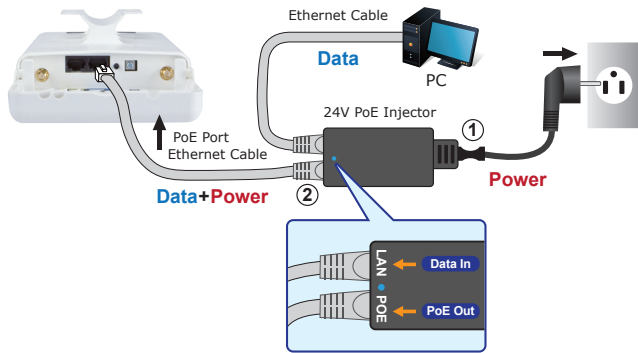

## 5. Pole Mounting

### STEP 1:

Place the strap through the slot on the back of the WNAP-6335 and then around the pole. Tighten the strap to secure the WNAP-6335.



- 5 -

Default IP Address: **192.168.1.253**  
 Default Username: **admin**  
 Default Password: **admin**  
 Default SSID: **WNAP-6335**

**STEP 1:** The Web management allows you to access and manage the wireless AP easily. Launch the Web browser and enter the default IP address <http://192.168.1.253>.



**STEP 2:** When the login window pops up, please enter the User Name and Password. The default User Name and Password are both **"admin"**. Then click the **OK** button to continue.



For security reasons, it is recommended to change the password at the first login and memorize it.

- 7 -

## 6. Web Login

Connect the WNAP-6335 with your PC via the PoE injector where one end of an Ethernet cable is plugged into the LAN port of the PoE injector while the other end into the LAN port of the PC. Power on the WNAP-6335 via the PoE injector.

1. Click the **"Start"** button located in the lower-left corner of your computer.
2. Click **"Control Panel"**.
3. Double-click the **"Network and Sharing Center"** icon.
4. Click **"Change Adapter Settings"**.
5. Double-click **"Local Area Connection"**.
6. Select **"Internet Protocol Version 4 (TCP/IPv4)"** and click **"Properties"**.
7. Select **"Use the following IP address"**, and then click **"OK"** button twice to save the configuration. For example, as the default IP address of the WNAP-6335 is 192.168.1.253 and the router is 192.168.1.254, then you may choose from 192.168.1.1 to 192.168.1.252.

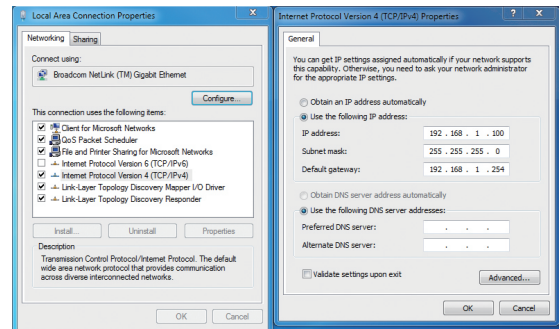

- 6 -

**STEP 3:** After you enter into the Web User Interface, go to **Wireless Basic Settings** to configure your wireless network.



## Further Information:

The above steps introduce the simple installations and configurations of the WNAP-6335. For further configurations of different operation modes, please refer to the user manual which can be downloaded from the website.

<http://www.planet.com.tw/en/support/download.php?type1=4&model=48687&type=3>

If you have further questions, please contact the local dealer or distributor where you purchased this product.



2011-E10600-000

- 8 -