

User's Manual

WGSW-24020
WGSW-48040

***24/48-Port 10/100/1000Mbps
with 2/4 Shared SFP
Managed Ethernet Switch***



Trademarks

Copyright © PLANET Technology Corp. 2007.

Contents subject to which revision without prior notice.

PLANET is a registered trademark of PLANET Technology Corp. All other trademarks belong to their respective owners.

Disclaimer

PLANET Technology does not warrant that the hardware will work properly in all environments and applications, and makes no warranty and representation, either implied or expressed, with respect to the quality, performance, merchantability, or fitness for a particular purpose.

PLANET has made every effort to ensure that this User's Manual is accurate; PLANET disclaims liability for any inaccuracies or omissions that may have occurred.

Information in this User's Manual is subject to change without notice and does not represent a commitment on the part of PLANET. PLANET assumes no responsibility for any inaccuracies that may be contained in this User's Manual. PLANET makes no commitment to update or keep current the information in this User's Manual, and reserves the right to make improvements to this User's Manual and/or to the products described in this User's Manual, at any time without notice.

If you find information in this manual that is incorrect, misleading, or incomplete, we would appreciate your comments and suggestions.

FCC Warning

This equipment has been tested and found to comply with the limits for a Class A digital device, pursuant to Part 15 of the FCC Rules. These limits are designed to provide reasonable protection against harmful interference when the equipment is operated in a commercial environment. This equipment generates, uses, and can radiate radio frequency energy and, if not installed and used in accordance with the Instruction manual, may cause harmful interference to radio communications. Operation of this equipment in a residential area is likely to cause harmful interference in which case the user will be required to correct the interference at whose own expense.

CE Mark Warning

This is a Class A product. In a domestic environment, this product may cause radio interference, in which case the user may be required to take adequate measures.

WEEE Warning



To avoid the potential effects on the environment and human health as a result of the presence of hazardous substances in electrical and electronic equipment, end users of electrical and electronic equipment should understand the meaning of the crossed-out wheeled bin symbol. Do not dispose of WEEE as unsorted municipal waste and have to collect such WEEE separately.

Revision

PLANET 24/48-Port 10/100/1000Mbps with 2/4 Shared SFP Managed Ethernet Switch User's Manual

FOR MODELS: WGSW-24020 / WGSW-48040

REVISION: 1.0 (MAY.2007)

Part No: EM-WGSW24020_484040_v1.0 (2081-A34030-001)

TABLE OF CONTENTS

| | |
|--|----|
| 1. INTRODUCTION | 14 |
| 1.1 Packet Contents | 14 |
| 1.2 How to Use This Manual | 14 |
| 1.3 Product Feature | 15 |
| 1.4 Product Specification | 16 |
| 2. INSTALLATION | 18 |
| 2.1 Product Description | 18 |
| 2.1.1 Product Overview | 18 |
| 2.1.2 Switch Front Panel | 18 |
| 2.1.3 LED Indications | 19 |
| 2.1.4 Switch Rear Panel | 19 |
| 2.2 Install the Switch | 20 |
| 2.2.1 Desktop Installation | 20 |
| 2.2.2 Rack Mounting | 21 |
| 2.2.3 Installing the SFP transceiver | 22 |
| 3. CONFIGURATION | 24 |
| 3.1 Management Access Overview | 24 |
| 3.1.1 Administration Console | 25 |
| 3.1.2 Direct Access | 25 |
| 3.2 Web Management | 25 |
| 3.3 SNMP-Based Network Management | 26 |
| 3.4 Protocols | 26 |
| 3.4.1 Virtual Terminal Protocols | 26 |
| 3.4.2 SNMP Protocol | 26 |
| 3.4.3 Management Architecture | 26 |
| 4. Web Configuration | 27 |
| 4.1 Main Screen | 29 |
| 4.2 Setup | 30 |
| 4.2.1 Summary | 30 |
| 4.2.2 Network Settings | 32 |
| 4.2.3 Time | 33 |
| 4.3 Port Configuration | 36 |
| 4.3.1 Port settings | 36 |
| 4.3.2 Link Aggregation | 38 |
| 4.3.3 LACP | 40 |
| 4.4 VLAN Configuration | 41 |
| 4.4.1 Create VLAN | 42 |
| 4.4.2 Port setting | 43 |
| 4.4.3 Ports to VLAN | 44 |

| | |
|--|-----|
| 4.4.4 GVRP | 45 |
| 4.5 Statistics | 46 |
| 4.5.1 RMON Statisti | 46 |
| 4.5.2 RMON History | 47 |
| 4.5.3 RMON Alarm | 49 |
| 4.5.4 RMON Events | 51 |
| 4.5.5 Port Utilization | 52 |
| 4.5.6 802.1x Statistics | 53 |
| 4.5.7 GVRP Statistics | 54 |
| 4.6 ACL | 57 |
| 4.6.1 IP Based ACL | 57 |
| 4.6.2 IP Based ACL Configure Sample | 60 |
| 4.6.3 MAC Based ACL | 63 |
| 4.6.4 MAC Based ACL Configure Sample | 65 |
| 4.7 Security | 69 |
| 4.7.1 ACL Binding | 69 |
| 4.7.2 Radius | 70 |
| 4.7.3 TACACS+ | 72 |
| 4.7.4 802.1x settings | 73 |
| 4.7.5 Port Security | 78 |
| 4.7.6 Multiple Hosts | 80 |
| 4.7.7 Storm control | 81 |
| 4.8 QoS | 82 |
| 4.8.1 CoS Settings | 82 |
| 4.8.2 Queue Setting | 84 |
| 4.8.3 DSCP Settings | 85 |
| 4.8.4 Bandwidth | 86 |
| 4.8.5 Basic Mode | 87 |
| 4.8.6 Advanced Mode | 88 |
| 4.9. Spanning Tree | 93 |
| 4.9.1 STP Status | 99 |
| 4.9.2 The Global STP | 100 |
| 4.9.3 STP Port Settings | 102 |
| 4.9.4 RSTP Port settings | 105 |
| 4.9.5 MSTP Properties | 106 |
| 4.9.6 MSTP Instance Settings | 107 |
| 4.9.7 MSTP Interface Settings | 109 |
| 4.10 Multicast | 111 |
| 4.10.1 IGMP Snooping | 113 |
| 4.10.2 Bridge Multicast | 115 |

| | |
|--|-----|
| 4.10.3 Bridge Multicast Forward All | 117 |
| 4.11 SNMP | 118 |
| 4.11.1 Global Parameters | 118 |
| 4.11.2 Views | 119 |
| 4.11.3 Group Profile | 120 |
| 4.11.4 Group Membership | 121 |
| 4.11.5 Communities | 123 |
| 4.11.6 Notification Filter | 125 |
| 4.11.7 Notification Recipient | 126 |
| 4.12 Admin | 128 |
| 4.12.1 User Authentication | 128 |
| 4.12.2 Static Address | 129 |
| 4.12.3 Dynamic Address | 131 |
| 4.12.4 Logging | 132 |
| 4.12.5 Port Mirroring | 133 |
| 4.12.6 Cable Test | 134 |
| 4.12.7 Save Configuration | 135 |
| 4.12.8 Jumbo Frame | 136 |
| 4.12.9 Firmware Upgrade | 136 |
| 4.12.10 Reboot | 138 |
| 4.12.11 Factory Defaults | 138 |
| 4.12.12 Server Logs | 138 |
| 4.12.13 Memory Logs | 140 |
| 4.12.14 Flash Logs | 141 |
| 5. COMMAND STRUCTURE | 142 |
| 5.1 Connect to PC's RS-232 serial port | 142 |
| 5.2 Using the CLI | 143 |
| 5.2.1 CLI Command Modes | 143 |
| 5.2.2 Starting the CLI | 145 |
| 5.2.3 Editing Features | 146 |
| 5.3 AAA Commands | 149 |
| 5.3.1 aaa authentication login | 149 |
| 5.3.2 aaa authentication enable | 150 |
| 5.3.3 login authentication | 151 |
| 5.3.4 enable authentication | 152 |
| 5.3.5 ip http authentication | 153 |
| 5.3.6 ip https authentication | 154 |
| 5.3.7 show authentication methods | 155 |
| 5.3.8 password | 156 |
| 5.3.9 enable password | 156 |

| | |
|--|-----|
| 5.3.10 username..... | 157 |
| 5.3.11 show users accounts | 158 |
| 5.4 Address Table Commands | 158 |
| 5.4.1 bridge address..... | 158 |
| 5.4.2 bridge multicast filtering | 159 |
| 5.4.3 bridge multicast address..... | 160 |
| 5.4.4 bridge multicast forbidden address..... | 161 |
| 5.4.5 bridge multicast forward-unregistered | 162 |
| 5.4.6 bridge multicast forbidden forward-unregistered..... | 162 |
| 5.4.7 bridge multicast forward-all..... | 163 |
| 5.4.8 bridge multicast forbidden forward-all..... | 164 |
| 5.4.9 bridge aging-time | 165 |
| 5.4.10 clear bridge..... | 165 |
| 5.4.11 port security | 166 |
| 5.4.12 port security routed secure-address | 166 |
| 5.4.13 show bridge address-table..... | 167 |
| 5.4.14 show bridge address-table static | 168 |
| 5.4.15 show bridge address-table count..... | 169 |
| 5.4.16 show bridge multicast address-table..... | 169 |
| 5.4.17 show bridge multicast filtering..... | 170 |
| 5.4.18 show ports security | 171 |
| 5.5 Clock Commands | 172 |
| 5.5.1 clock set..... | 172 |
| 5.5.2 clock source..... | 173 |
| 5.5.3 clock timezone..... | 173 |
| 5.5.4 clock summer-time | 174 |
| 5.5.5 snmp authentication-key..... | 176 |
| 5.5.6 snmp authenticate | 176 |
| 5.5.7 snmp trusted-key | 177 |
| 5.5.8 snmp client poll timer | 177 |
| 5.5.9 snmp broadcast client enable | 178 |
| 5.5.10 snmp anycast client enable | 179 |
| 5.5.11 snmp client enable (interface)..... | 179 |
| 5.5.12 snmp unicast client enable | 180 |
| 5.5.13 snmp unicast client poll..... | 180 |
| 5.5.14 snmp server..... | 181 |
| 5.5.15 show clock..... | 182 |
| 5.5.16 show snmp configuration | 183 |
| 5.5.17 show snmp status..... | 184 |
| 5.6 Configuration and Image Files | 185 |

| | |
|--|-----|
| 5.6.1 copy | 185 |
| 5.6.2 show startup-config..... | 188 |
| 5.7 Ethernet Configuration Commands..... | 190 |
| 5.7.1 interface ethernet..... | 190 |
| 5.7.2 interface range ethernet..... | 190 |
| 5.7.3 shutdown | 191 |
| 5.7.4 description | 192 |
| 5.7.5 speed..... | 192 |
| 5.7.6 duplex..... | 193 |
| 5.7.7 negotiation | 194 |
| 5.7.8 flowcontrol | 194 |
| 5.7.9 mdix..... | 195 |
| 5.7.10 back-pressure | 196 |
| 5.7.11 port jumbo-frame..... | 196 |
| 5.7.12 clear counters | 197 |
| 5.7.13 set interface active..... | 197 |
| 5.7.14 show interfaces configuration | 198 |
| 5.7.15 show interfaces status | 199 |
| 5.7.16 show interfaces description | 201 |
| 5.7.17 show interfaces counters | 201 |
| 5.7.18 show ports jumbo-frame | 204 |
| 5.7.19 port storm-control broadcast enable | 205 |
| 5.7.20 port storm-control broadcast rate..... | 205 |
| 5.7.21 show ports storm-control | 206 |
| 5.8 GVRP Commands | 207 |
| 5.8.1 gvrp enable (global)..... | 207 |
| 5.8.2 gvrp enable (interface)..... | 207 |
| 5.8.3 garp timer | 208 |
| 5.8.4 gvrp vlan-creation-forbid | 209 |
| 5.8.5 gvrp registration-forbid..... | 210 |
| 5.8.7 clear gvrp statistics | 210 |
| 5.8.8 show gvrp configuration..... | 211 |
| 5.8.9 show gvrp statistics..... | 212 |
| 5.8.10 show gvrp error-statistics..... | 213 |
| 5.9 IGMP Snooping Commands | 214 |
| 5.9.1 ip igmp snooping (Global)..... | 214 |
| 5.9.2 ip igmp snooping (Interface) | 214 |
| 5.9.3 ip igmp snooping mrouter | 215 |
| 5.9.4 ip igmp snooping host-time-out..... | 215 |
| 5.9.5 ip igmp snooping mrouter-time-out | 216 |

| | |
|---|-----|
| 5.9.6 ip igmp snooping leave-time-out | 217 |
| 5.9.7 show ip igmp snooping mrouter | 217 |
| 5.9.8 show ip igmp snooping interface | 218 |
| 5.9.9 show ip igmp snooping groups | 219 |
| 5.10 IP Addressing Commands | 220 |
| 5.10.1 ip address | 220 |
| 5.10.2 ip address dhcp | 220 |
| 5.10.3 ip default-gateway | 221 |
| 5.10.4 show ip interface | 222 |
| 5.10.5 arp | 223 |
| 5.10.6 arp timeout | 223 |
| 5.10.7 clear arp-cache | 224 |
| 5.10.8 show arp | 224 |
| 5.11 LACP Commands | 225 |
| 5.11.1 lacp system-priority | 225 |
| 5.11.2 lacp port-priority | 226 |
| 5.11.3 lacp timeout | 226 |
| 5.11.4 show lacp ethernet | 227 |
| 5.11.5 show lacp port-channel | 228 |
| 5.12 Line Commands | 229 |
| 5.12.1 line | 229 |
| 5.12.2 speed | 229 |
| 5.12.3 exec-timeout | 230 |
| 5.12.4 show line | 230 |
| 5.13 Management ACL Commands | 231 |
| 5.13.1 management access-list | 231 |
| 5.13.2 permit (management) | 233 |
| 5.13.3 deny (management) | 233 |
| 5.13.4 management access-class | 234 |
| 5.13.5 show management access-list | 235 |
| 5.13.6 show management access-class | 236 |
| 5.14 PHY Diagnostics Commands | 236 |
| 5.14.1 test copper-port tdr | 236 |
| 5.14.2 show copper-ports tdr | 237 |
| 5.14.3 show copper-ports cable-length | 238 |
| 5.14.4 show fiber-ports optical-transceiver | 238 |
| 5.15 Port Channel Commands | 240 |
| 5.15.1 interface port-channel | 240 |
| 5.15.2 interface range port-channel | 241 |
| 5.15.3 channel-group | 241 |

| | |
|--|-----|
| 5.15.4 show interfaces port-channel | 242 |
| 5.16 Port Monitor Commands | 243 |
| 5.16.1 port monitor | 243 |
| 5.16.2 show ports monitor | 244 |
| 5.17 QoS Commands | 246 |
| 5.17.1 qos..... | 246 |
| 5.17.2 show qos | 246 |
| 5.17.3 wrr-queue cos-map..... | 247 |
| 5.17.4 wrr-queue bandwidth | 248 |
| 5.17.5 priority-queue out num-of-queues..... | 249 |
| 5.17.6 show qos interface..... | 249 |
| 5.17.7 qos map dscp-queue | 252 |
| 5.17.8 qos trust (Global)..... | 253 |
| 5.17.9 qos trust (Interface) | 254 |
| 5.17.10 qos cos | 254 |
| 5.17.11 qos cos override..... | 255 |
| 5.17.12 show qos map | 256 |
| 5.18 Radius Commands | 257 |
| 5.18.1 radius-server host..... | 257 |
| 5.18.2 radius-server key | 259 |
| 5.18.3 radius-server retransmit..... | 259 |
| 5.18.4 radius-server source-ip..... | 260 |
| 5.18.5 radius-server timeout..... | 260 |
| 5.18.6 radius-server deadtime | 261 |
| 5.18.7 show radius-servers | 262 |
| 5.19 RMON Commands | 263 |
| 5.19.1 show rmon statistics | 263 |
| 5.19.2 rmon collection history | 265 |
| 5.19.3 show rmon collection history..... | 265 |
| 5.19.4 show rmon history | 266 |
| 5.19.5 rmon alarm | 269 |
| 5.19.6 show rmon alarm-table | 270 |
| 5.19.7 show rmon alarm | 271 |
| 5.19.8 rmon event..... | 273 |
| 5.19.9 show rmon events..... | 274 |
| 5.19.10 show rmon log | 275 |
| 5.19.11 rmon table-size | 276 |
| 5.20 SNMP Commands | 277 |
| 5.20.1 snmp-server community | 277 |
| 5.20.2 snmp-server contact | 278 |

| | |
|--|-----|
| 5.20.3 snmp-server location | 279 |
| 5.20.4 snmp-server enable traps | 279 |
| 5.20.5 snmp-server trap authentication | 280 |
| 5.20.6 snmp-server host | 280 |
| 5.20.7 snmp-server set | 281 |
| 5.20.8 show snmp | 282 |
| 5.21 Spanning-Tree Commands | 284 |
| 5.21.1 spanning-tree | 284 |
| 5.21.2 spanning-tree mode | 284 |
| 5.21.3 spanning-tree forward-time | 285 |
| 5.21.4 spanning-tree hello-time | 285 |
| 5.21.5 spanning-tree max-age | 286 |
| 5.21.6 spanning-tree priority | 287 |
| 5.21.7 spanning-tree disable | 287 |
| 5.21.8 spanning-tree cost | 288 |
| 5.21.9 spanning-tree port-priority | 289 |
| 5.21.10 spanning-tree portfast | 289 |
| 5.21.11 spanning-tree link-type | 290 |
| 5.21.12 spanning-tree bpdu | 291 |
| 5.21.13 clear spanning-tree detected-protocols | 292 |
| 5.21.14 show spanning-tree | 292 |
| 5.22 SSH and SLOGIN Commands | 294 |
| 5.22.1 ip ssh port | 294 |
| 5.22.2 ip ssh server | 295 |
| 5.22.3 crypto key generate dsa | 296 |
| 5.22.4 crypto key generate rsa | 296 |
| 5.22.5 ip ssh pubkey-auth | 297 |
| 5.22.6 crypto key pubkey-chain ssh | 297 |
| 5.22.7 user-key | 298 |
| 5.22.8 key-string | 299 |
| 5.22.9 show ip ssh | 300 |
| 5.22.10 show crypto key mypubkey | 301 |
| 5.22.11 show crypto key pubkey-chain ssh | 301 |
| 5.23 System Management | 302 |
| 5.23.1 ping | 302 |
| 5.23.2 traceroute | 303 |
| 5.23.3 telnet | 306 |
| 5.23.4 resume | 308 |
| 5.23.5 reload | 309 |
| 5.23.6 hostname | 310 |

| | |
|--------------------------------------|-----|
| 5.23.7 show users | 310 |
| 5.23.8 show sessions | 311 |
| 5.23.9 show system | 312 |
| 5.23.10 show version | 313 |
| 5.24 Syslog Commands | 313 |
| 5.24.1 logging on | 313 |
| 5.24.2 logging | 314 |
| 5.24.3 logging console | 315 |
| 5.24.4 logging buffered | 316 |
| 5.24.5 logging buffered size | 316 |
| 5.24.6 clear logging | 317 |
| 5.24.7 logging file | 317 |
| 5.24.8 clear logging file | 318 |
| 5.24.9 show logging | 319 |
| 5.24.10 show logging file | 320 |
| 5.24.11 show syslog-servers | 321 |
| 5.25 TACACS Commands | 322 |
| 5.25.1 tacacs-server host | 322 |
| 5.25.2 tacacs-server key | 323 |
| 5.25.3 tacacs-server timeout | 323 |
| 5.25.4 tacacs-server source-ip | 324 |
| 5.25.5 show tacacs | 325 |
| 5.26 User Interface Commands | 326 |
| 5.26.1 enable | 326 |
| 5.26.2 disable | 327 |
| 5.26.3 configure | 327 |
| 5.26.4 login | 328 |
| 5.26.5 exit(configuration) | 328 |
| 5.26.6 exit(EXEC) | 329 |
| 5.26.7 end | 329 |
| 5.26.8 help | 330 |
| 5.26.9 history | 330 |
| 5.26.10 history size | 331 |
| 5.26.11 show history | 331 |
| 5.26.12 show privilege | 332 |
| 5.27 VLAN Commands | 333 |
| 5.27.1 vlan database | 333 |
| 5.27.2 vlan | 333 |
| 5.27.3 default-vlan disable | 334 |
| 5.27.4 interface vlan | 335 |

| | |
|--|-----|
| 5.27.5 interface range vlan | 335 |
| 5.27.6 name..... | 336 |
| 5.27.7 switchport mode | 336 |
| 5.27.8 switchport access vlan..... | 337 |
| 5.27.9 switchport trunk allowed vlan..... | 338 |
| 5.27.10 switchport trunk native vlan | 339 |
| 5.27.11 switchport general allowed vlan | 339 |
| 5.27.12 switchport general pvid..... | 340 |
| 5.27.13 switchport general ingress-filtering disable | 341 |
| 5.27.14 switchport general acceptable-frame-type taggedonly..... | 341 |
| 5.27.15 switchport forbidden vlan | 342 |
| 5.27.16 map protocol protocols-group | 343 |
| 5.27.17 switchport general map protocols-group vlan | 344 |
| 5.27.18 ip internal-usage-vlan | 344 |
| 5.27.19 show vlan..... | 345 |
| 5.27.20 show vlan internal usage | 346 |
| 5.27.21 show interfaces switchport..... | 346 |
| 5.28 Web Server Commands..... | 348 |
| 5.28.1 ip http server..... | 348 |
| 5.28.2 ip http port..... | 348 |
| 5.28.3 ip https server | 349 |
| 5.28.4 ip https port..... | 350 |
| 5.28.5 crypto certificate generate | 350 |
| 5.28.6 show ip http | 351 |
| 5.28.7 show ip https..... | 351 |
| 5.29 802.1x Commands..... | 352 |
| 5.29.1 aaa authentication dot1x..... | 352 |
| 5.29.2 dot1x system-auth-control | 353 |
| 5.29.3 dot1x port-control..... | 353 |
| 5.29.4 dot1x re-authentication | 354 |
| 5.29.5 dot1x timeout re-authperiod..... | 355 |
| 5.29.6 dot1x re-authenticate | 355 |
| 5.29.7 dot1x timeout quiet-period | 356 |
| 5.29.8 dot1x timeout tx-period | 357 |
| 5.29.9 dot1x max-req..... | 358 |
| 5.29.10 dot1x timeout supp-timeout | 358 |
| 5.29.11 dot1x timeout server-timeout | 359 |
| 5.29.12 show dot1x | 360 |
| 5.29.13 show dot1x users..... | 362 |
| 5.29.14 show dot1x statistics..... | 363 |

| | |
|---|-----|
| 5.29.15 dot1x auth-not-req | 364 |
| 5.29.16 dot1x multiple-hosts | 365 |
| 5.29.17 dot1x single-host-violation | 366 |
| 5.29.18 show dot1x advanced | 366 |
| TROUBLE SHOOTING | 368 |
| APPENDEX A | 369 |
| A.1 Switch's RJ-45 Pin Assignments | 369 |
| A.2 RJ-45 cable pin assignment | 369 |
| A.3 Available Modules | 371 |

1. INTRODUCTION

Thank you for purchasing PLANET WGSW Gigabit Managed Switch- WGSW-24020 and WGSW-48040. In the following section, the term “**Switch**” means the two Switches, i.e. WGSW-24020 and WGSW-48040; term of “**switch**” can be any third part switches.

1.1 Packet Contents

Check the contents of your package for following parts:

- The WGSW Managed Switch x1
- CD-ROM user's manual x1
- Quick installation guide x1
- 19" rack mounting kit x1
- Power Cord x1
- RS-232 console x 1
- Rubber feet x 4



If any of these are missing or damaged, please contact your dealer immediately, if possible, retain the carton including the original packing material, and use them against to repack the product in case there is a need to return it to us for repair.

1.2 How to Use This Manual

This User Manual is structured as follows:

- **Section 2, Installation**
The section explains the functions of the Switch and how to physically install the Switch.
- **Section 3, Configuration**
The section contains the information about the software function of the Switch.
- **Section 4, Web Configuration**
The section explains how to manage the Switch by Web interface.
- **Section 5, COMMAND STRUCTURE**
The section explains how to manage the Switch by Console interface..
- **Appendix A**
The section contains cable information of the Switch.

1.3 Product Feature

➤ **Physical Port**

WGSW-24020

- 24-Port 10/100/1000Base-T RJ-45
- 2 SFP slots, shared with Port#12 and Port#24
- Console interface for Switch basic management and setup

WGSW-48040

- 48-Port 10/100/1000Base-T RJ-45
- 4 SFP slots, shared with Port#23, Port#24, Port#47 and Port#48
- Console interface for Switch basic management and setup

➤ **Layer 2 Features**

- Complies with the IEEE 802.3, IEEE 802.3u, IEEE 802.3ab, IEEE 802.3z Gigabit Ethernet standard
- Supports Auto-negotiation and half duplex/full duplex modes for all 10Base-T/100Base-TX and 1000Base-T ports.
- Auto-MDI/MDI-X detection on each RJ-45 port
- Prevents packet loss with back pressure (Half-Duplex) and IEEE 802.3x PAUSE frame flow control (Full-Duplex)
- High performance Store and Forward architecture, broadcast storm control, runt/CRC filtering eliminates erroneous packets to optimize the network bandwidth
- 8K MAC address table, automatic source address learning and ageing
- 6Mbit embedded memory for packet buffers
- Supports IEEE 802.1Q Tagged based VLAN
- GVRP protocol for VLAN Management
- Support up to 8 Trunk groups, each trunk for up to maximum 8 port with 1.6Gbps bandwidth (Duplex Mode)
- IEEE802.1d, IEEE802.1w, classic Spanning Tree Algorithm or Rapid Spanning Tree support
- Supports the IEEE 802.1s specification for multiple spanning trees on a single port (spanning tree per VLAN).

➤ **Quality of Service**

- 4 priority queues on all switch ports.
- Support for strict priority and weighted round robin (WRR) CoS policies
- Support QoS and bandwidth control on each port
- Traffic-policing policies on the switch port

➤ **Multicast**

- Support IGMP Snooping v1 and v2
- Port Mirroring to monitor the incoming or outgoing traffic on a particular port

➤ **Security**

- 802.1x Port-Based Authentication
- IP-Based Access Control List (ACL)
- MAC-Based Access Control List
- Port Security

Management

- WEB-Based, Telnet, Console Command Line management
- SSH(Secure Shell), SSL
- Access through SNMPv1, v2c and v3 security set and gets requests.
- Four groups (**history, statistics, alarms, and events**) of embedded remote monitoring (**RMON**) agents for network monitoring and traffic analysis
- Built-in Trivial File Transfer Protocol (**TFTP**) client
- Virtual Cable Test (**VCT**) technology provides the mechanism to detect and report potential cabling issues, such as cable opens, cable shorts, etc. on Copper Links
- EMI standards comply with FCC, CE class A

1.4 Product Specification

| Products | WGSW-24020 | WGSW-48040 |
|-------------------------------|---|--|
| Description | 24-Port 10/100/1000Mbps with 2 Shared SFP Managed Gigabit Switch | 48-Port 10/100/1000Mbps with 4 Shared SFP Managed Gigabit Switch |
| Hardware Specification | | |
| 10/100/1000Base-T Ports | 24 RJ-45 Auto-MDI/MDI-X ports | 48 RJ-45 Auto-MDI/MDI-X ports |
| SFP/mini-GBIC Slots | 2 SFP interfaces (Shared with Port#12 and Port#24) | 4 SFP interfaces (Shared with Port#23, 24, 47 and 48) |
| Switch Architecture | Store-and-Forward | |
| Switch Fabric | 48Gbps | 96Gbps |
| Switch Throughput | 35.7Mpps / Wire-Speed | 71.4Mpps / Wire-Speed |
| Address Table | 8K entries | |
| Share data Buffer | 6 Mbit | |
| Flow Control | Back pressure for Half-Duplex, IEEE 802.3x Pause Frame for Full-Duplex | |
| Jumbo Frame | 9K bytes per 10/100/1000Base-T Ports | |
| Dimension | 430 x 350 x 44.5mm (W x D x H), 1U height | |
| Weight | 3.4 KG | 3.5KG |
| Power Requirement | 100~240V AC, 50-60, Auto-sensing | |
| Layer 2 function | | |
| Management Interface | Console. Telnet, SSH, Web Browser, SSL, SNMPv1, v2c and v3 | |
| Port configuration | Port disable/enable. Auto-negotiation 10/100Mbps full and half duplex mode selection. Flow Control disable / enable. Bandwidth control on each port. | |
| Port Status | Display each port's speed duplex mode, link status, Flow control status. Auto negotiation status, trunk status. | |
| VLAN | IEEE 802.1Q Tagged Based VLAN ,up to 255 VLAN groups | |

| | |
|------------------------------|---|
| Link Aggregation | Supports 8 groups of 8-Port trunk support, IEEE 802.3ad LACP |
| QoS | Traffic classification based on Port Number, 802.1p priority and DS/TOS field in IP Packet |
| IGMP Snooping | Allow to be disabled or enable. Supports IGMP Snooping v1 and v2 |
| SNMP MIBs | <p>RFC-1213 MIB-2</p> <p>RFC-2863 Interface MIB</p> <p>RFC-2665 EtherLike MIB</p> <p>RFC-1493 Bridge MIB</p> <p>RFC-2674 Extended Bridge MIB</p> <p>RFC-2819 RMON MIB (Group 1, 2, 3 and 9)</p> <p>RFC-2737 Entity MIB</p> <p>RFC-2618 RADIUS Client MIB</p> |
| Standards Conformance | |
| Regulation Compliance | FCC Part 15 Class A, CE |
| Standards Compliance | <p>IEEE 802.3 10BASE-T</p> <p>IEEE 802.3u 100BASE-TX/100BASE-FX</p> <p>IEEE 802.3z Gigabit SX/LX</p> <p>IEEE 802.3ab Gigabit 1000T</p> <p>IEEE 802.3x Flow Control and Back pressure</p> <p>IEEE 802.3ad Port trunk with LACP</p> <p>IEEE 802.1d Spanning tree protocol</p> <p>IEEE 802.1w Rapid spanning tree protocol</p> <p>IEEE 802.1p Class of service</p> <p>IEEE 802.1Q VLAN Tagging</p> |
| Environment | |
| Regulation Compliance | FCC Part 15 Class A, CE |
| Operating Temperature | 0°C~50°C, |
| Storage Temperature | -40°C~70°C, |
| Operating Humidity | 5% to 90%, relative humidity, non-condensing |
| Storage Humidity | 5% to 90%, relative humidity, non-condensing |

2. INSTALLATION

This section describes the functionalities of the Switch's components and guides how to install it on the desktop or shelf. Basic knowledge of networking is assumed. Please read this chapter completely before continuing.

2.1 Product Description

The PLANET WGSW-24020/WGSW-48040 is a 24/48-Port 10/100/1000Mbps with 2/4 shared SFP interfaces Gigabit Ethernet Switch. It boasts a high performance switch architecture that is capable of providing non-blocking switch fabric and wire-speed throughput as high as 48Gbps and 96Gbps. Its two/four built-in GbE uplink ports also offer incredible extensibility, flexibility and connectivity to the Core switch or Servers.

2.1.1 Product Overview

PLANET WGSW-24020/WGSW-48040 is loaded with powerful traffic management and QoS features to enhance services offered by telecom. It provides 4 priority queues per port for different types of traffic, allowing administrators to set policies for classified filtering and rule-based rate limitation. The WGSW-24020/WGSW-48040 prioritizes applications with WFQ (**Weighted Fair Queuing**) scheduling algorithm to allocate more bandwidth to key traffics such as voice transmission, empowering the enterprise to take full advantages of the limited network resources and guarantee the best performance.

PLANET WGSW-24020/WGSW-48040 offers comprehensive Access Control List (**ACL**) for enforcing security to the edge. Its protection mechanisms comprised of port-based 802.1x user and device authentication. The administrators can now construct highly secured corporate networks with time and effort considerably less than before.

With its built-in web-based management, the PLANET WGSW-24020/WGSW-48040 offers an easy-to-use, platform-independent management and configuration facility. The PLANET WGSW-24020 /WGSW-48040 support standard Simple Network Management Protocol (**SNMP**) and can be managed via any standard-based management software. For text-based management, the WGSW-24020/WGSW-48040 can also be accessed via Telnet and the console interfaces. For secure remote management, the WGSW-24020/WGSW-48040 supports SSL and SSH connection which encrypt the packet content at each session.

2.1.2 Switch Front Panel

Figure 2-1 shows the front panel of the Switch.

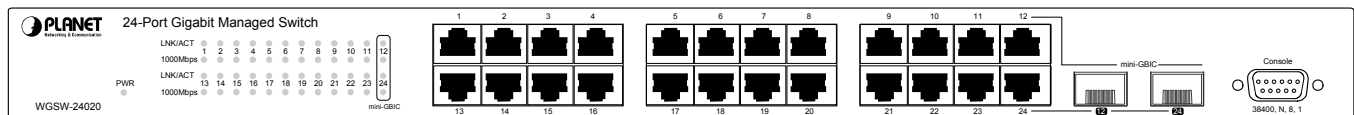

Figure 2-1 WGSW-24020 front panel.



Figure 2-2 WGSW-48040 front panel.

2.1.3 LED Indications

2.1.3.1 WGSW-24020 LED Indications

■ System

| LED | Color | Function |
|-----|-------|---|
| PWR | Green | Lights to indicate that the Switch has power. |

■ Per Per 10/100/1000Base-T RJ-45 port /SFP interfaces (Shared with 10/100/1000Base-T Port#12 and Port#24)

| LED | Color | Function |
|---------|--------|---|
| LNK/ACT | Green | Lights to indicate the link through that port is successfully established. Blink: indicate that the Switch is actively sending or receiving data over that port. |
| 1000 | Orange | Lights to indicate the port is running in 1000Mbps speed. Off: indicate that the port is operating at 10Mbps or 100Mbps. |

2.1.3.2 WGSW-48040 LED Indications

■ System

| LED | Color | Function |
|-----|-------|---|
| PWR | Green | Lights to indicate that the Switch has power. |

■ Per 10/100/1000Base-T RJ-45 port

| LED | Color | Function |
|-------------------------|--------|--|
| LNK/ACT (Dual Color) | Orange | Lights to indicate the port is running in 1000Mbps speed. Blink: indicate that the Switch is actively sending or receiving data over that port. |
| | Green | Lights: indicate that the port is operating at 10Mbps or 100Mbps. Blink: indicate that the Switch is actively sending or receiving data over that port. |

■ Per SFP interfaces (Shared with 10/100/1000Base-T Port#23, Port#24, Port#47 and Port#48)

| LED | Color | Function |
|---------|--------|---|
| LNK/ACT | Orange | Lights to indicate the link through that port is successfully established. Blink: indicate that the switch is actively sending or receiving data over that port. |

2.1.4 Switch Rear Panel

Figure 2-3 and 2-4 shows the rear panel of the Switch

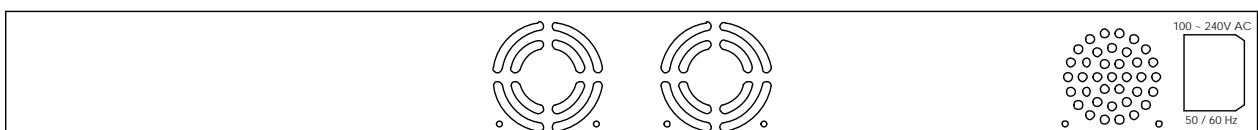

Figure 2-3 WGSW-24020 rear panel.



Figure 2-4 WGSW-48040 rear panel.

Power Notice:

1. The device is a power-required device, it means, it will not work till it is powered. If your networks should active all the time, please consider using UPS (Uninterrupted Power Supply) for your device. It will prevent you from network data loss or network downtime.
2. In some area, installing a surge suppression device may also help to protect your switch from being damaged by unregulated surge or current to the Switch or the power adapter.

2.2 Install the Switch

This section describes how to install the Ethernet Switch and make connections to the Switch. Please read the following topics and perform the procedures in the order being presented. To install your Switch on a desktop or shelf, simply complete the following steps.

2.2.1 Desktop Installation

To install the Switch on desktop or shelf, please follows these steps:

Step1: Attach the rubber feet to the recessed areas on the bottom of the Switch.

Step2: Place the Switch on the desktop or the shelf near an AC power source.

Step3: Keep enough ventilation space between the Switch and the surrounding objects.

 **Notice:** When choosing a location, please keep in mind the environmental restrictions discussed in Chapter 1, Section 4, and Specification.

Step4: Connect the Switch to network devices.

- A. Connect one end of a standard network cable to the 10/100 RJ-45 ports or Gigabit RJ-45 / SFP mini-GBIC slot on the front of the Switch.
 - B. Connect the other end of the cable to the network devices such as printer servers, workstations or routers...etc.
-

 **Notice:** Connection to the Switch requires UTP Category 5 network cabling with RJ-45 tips. For more information, please see the Cabling Specification in Appendix A.

Step5: Supply power to the Switch.

- A. Connect one end of the power cable to the Switch.
- B. Connect the power plug of the power cable to a standard wall outlet.

When the Switch receives power, the Power LED should remain solid Green.

2.2.2 Rack Mounting

To install the Switch in a **19-inch** standard rack, please follows the instructions described below.

Step1: Place the Switch on a hard flat surface, with the front panel positioned towards the front side.

Step2: Attach the rack-mount bracket to each side of the Switch with supplied screws attached to the package. Figure 2-5 shows how to attach brackets to one side of the Switch.

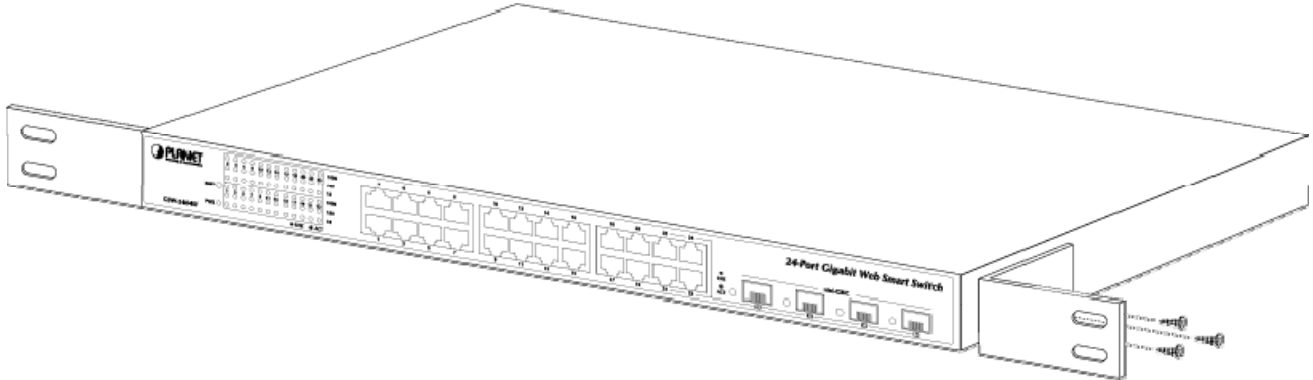

Figure 2-5 Attach brackets to the Switch.

Caution:

You must use the screws supplied with the mounting brackets. Damage caused to the parts by using incorrect screws would invalidate the warranty.

Step3: Secure the brackets tightly.

Step4: Follow the same steps to attach the second bracket to the opposite side.

Step5: After the brackets are attached to the Switch, use suitable screws to securely attach the brackets to the rack, as shown in Figure 2-6.

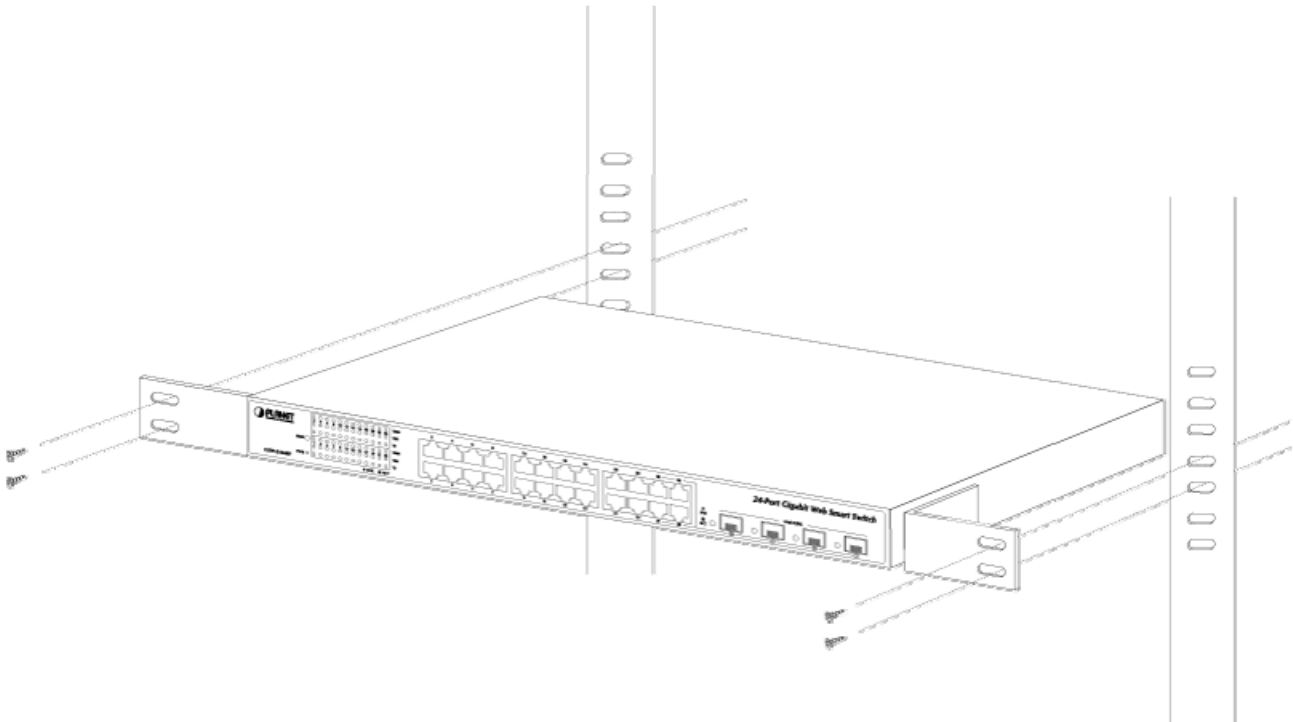

Figure 2-6 Mounting the Switch in a Rack

Step6: Proceeds with the steps 4 and steps 5 of session 2.2.1 **Desktop Installation** to connect the network cabling and supply power to the Switch.

2.2.3 Installing the SFP transceiver

The sections describe how to insert an SFP transceiver into an SFP slot.

The SFP transceivers are hot-pluggable and hot-swappable. You can plug-in and out the transceiver to/from any SFP port without having to power down the Switch. As the Figure 2-7 appears.

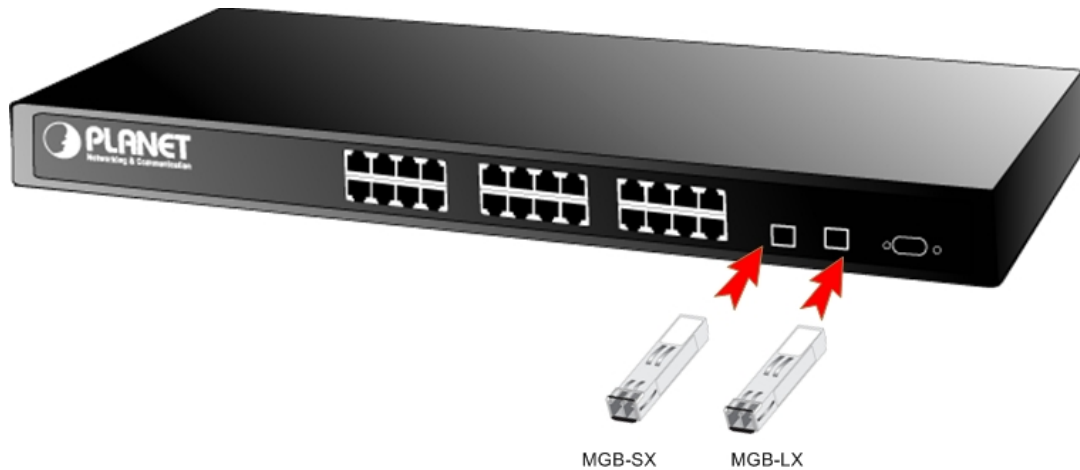

Figure 2-7 Plug-in the SFP transceiver

Approved PLANET SFP Transceivers

PLANET WGSW-24020/WGSW-48040 support both single mode and multi mode SFP transceiver. The following list of approved PLANET SFP transceivers is correct at the time of publication:

- MGB-SX SFP (1000BASE-SX SFP transceiver)
- MGB-LX SFP (1000BASE-LX SFP transceiver)



Notice:

It recommends using PLANET SFPs on the Switch. If you insert a SFP transceiver that is not supported, the Switch will not recognize it.

Before connect the other switches, workstation or Media Converter.

1. Make sure both side of the SFP transfer are with the same media type, for example: 1000Base-SX to 1000Base-SX, 1000Bas-LX to 1000Base-LX.
2. Check the fiber-optic cable type match the SFP transfer model.
 - To connect to **1000Base-SX** SFP transfer, use the **multi-mode** fiber cable- with one side must be male duplex LC connector type.
 - To connect to **1000Base-LX** SFP transfer, use the **single-mode** fiber cable-with one side must be male duplex LC connector type.

Connect the fiber cable

1. Attach the duplex LC connector on the network cable into the SFP transceiver.
2. Connect the other end of the cable to a device – switches with SFP installed, fiber NIC on a workstation or a Media Converter.
3. Check the LNK/ACT LED of the SFP slot on the front of the Switch. Ensure that the SFP transceiver is operating correctly.
4. Check the Link mode of the SFP port if the link failed. Co works with some fiber-NICs or Media Converters, set the Link mode to “**1000 Force**” is needed.

Remove the transceiver module

1. Make sure there is no network activity by consult or check with the network administrator. Or through the management interface of the switch/converter (if available) to disable the port in advance.
2. Remove the Fiber Optic Cable gently.
3. Turn the handle of the MGB/MFB module to horizontal.
4. Pull out the module gently through the handle.

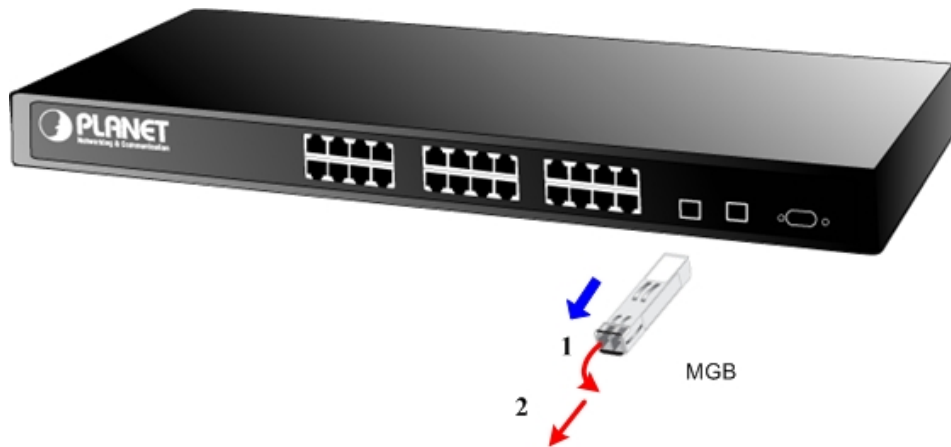

Figure 2-8 Pull out the SFP transceiver



Notice:

Never pull out the module without pull the handle or the push bolts on the module. Direct pull out the module with violent could damage the module and SFP module slot of the device.

3. CONFIGURATION

This chapter explains the methods that you can use to configure management access to the Switch. It describes the types of management applications and the communication and management protocols that deliver data between your management device (work-station or personal computer) and the system. It also contains information about port connection options.

This chapter covers the following topics:

- Management Access Overview
- Key Concepts
- Key Guidelines for Implementation
- Administration Console Access
- Web Management Access
- SNMP Access
- Standards, Protocols, and Related Reading

3.1 Management Access Overview

The Switch gives you the flexibility to access and manage the Switch using any or all of the following methods:

- An administration console
- Web browser interface
- An external SNMP-based network management application

The administration console and Web browser interface support are embedded in the Switch software and are available for immediate use. Each of these management methods has their own advantages. Table 3-1 compares the three management methods.

| Method | Advantages | Disadvantages |
|--------------------|---|--|
| Console | <ul style="list-style-type: none"> • No IP address or subnet needed. • Text-based. • Telnet functionality and HyperTerminal built into Windows 95/98/NT/2000/ME/XP operating systems. • Secure. | <ul style="list-style-type: none"> • Must be near switch or use dial-up connection. • Not convenient for remote users. • Modem connection may prove to be unreliable or slow. |
| Web Browser | <ul style="list-style-type: none"> • Ideal for configuring the switch remotely. • Compatible with all popular browsers. • Can be accessed from any location. • Most visually appealing. | <ul style="list-style-type: none"> • Security can be compromised (hackers need only know the IP address and subnet mask). • May encounter lag times on poor connections. |
| SNMP Agent | <ul style="list-style-type: none"> • Communicates with switch functions at the MIB level. • Based on open standards. | <ul style="list-style-type: none"> • Requires SNMP manager software. • Least visually appealing of all three methods. • Some settings require calculations. • Security can be compromised (hackers need only know the community name). |

Table 3-1 Management Methods Comparison

3.1.1 Administration Console

The administration console is an internal, character-oriented, and command line user interface for performing system administration such as displaying statistics or changing option settings. Using this method, you can view the administration console from a terminal, personal computer, Apple Macintosh, or workstation connected to the switch's console (**serial**) port. There are two ways to use this management method: via direct access or modem port access. The following sections describe these methods. For more information about using the console, refer to Chapter 5 Command Line Interface Console Management.

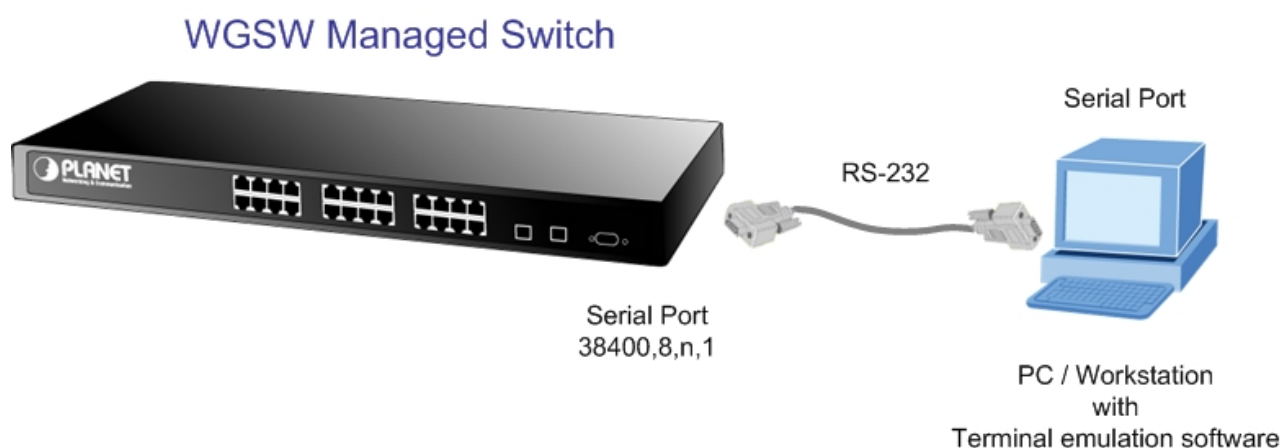

3.1.2 Direct Access

Direct access to the administration console is achieved by directly connecting a terminal or a PC equipped with a terminal-emulation program (**such as HyperTerminal**) to the Switch console (**serial**) port.

When using this management method, a null-modem cable is required to connect the Switch to the PC. After making this connection, configure the terminal-emulation program to use the following parameters:

The default parameters are:

- **38400 bps**
- **8 data bits**
- **No parity**
- **1 stop bit**

You can change these settings, if desired, after you log on. This management method is often preferred because you can remain connected and monitor the system during system reboots. Also, certain error messages are sent to the serial port, regardless of the interface through which the associated action was initiated. A Macintosh or PC attachment can use any terminal-emulation program for connecting to the terminal serial port. A workstation attachment under UNIX can use an emulator such as TIP.

3.2 Web Management

The Switch provides a browser interface that lets you configure and manage the switch remotely. After you set up your IP address for the Switch, you can access the Switch's Web interface applications directly in your Web browser by entering the IP address of the Switch. You can then use your Web browser to list and manage Switch configuration parameters from one central location, just as if you were directly connected to the Switch's console port.

Web Management requires either Microsoft Internet Explorer 4.01 or later or Netscape Navigator 4.03 or later.

3.3 SNMP-Based Network Management

You can use an external SNMP-based application to configure and manage the Switch. This management method requires the SNMP agent on the switch and the SNMP Network Management Station to use the same community string. This management method, in fact, uses two community strings: the get community string and the set community string. If the SNMP Network management Station only knows the set community string, it can read and write to the MIBs. However, if it only knows the get community string, it can only read MIBs. The default gets and sets community strings for the Switch are public.

3.4 Protocols

The Switch supports the following protocols:

- Virtual terminal protocols, such as Telnet
- Simple Network Management Protocol (SNMP)

3.4.1 Virtual Terminal Protocols

A virtual terminal protocol is a software program, such as Telnet, that allows you to establish a management session from a Macintosh, a PC, or a UNIX workstation. Because Telnet runs over TCP/IP, you must have at least one IP address configured on the switch before you can establish access to it with a virtual terminal protocol.

**Notice:**

Terminal emulation differs from a virtual terminal protocol in that you must connect a terminal directly to the console (serial) port.

3.4.2 SNMP Protocol

Simple Network Management Protocol (SNMP) is the standard management protocol for multi-vendor IP networks. SNMP supports transaction-based queries that allow the protocol to format messages and to transmit information between reporting devices and data-collection programs. SNMP runs on top of the User Datagram Protocol (UDP), offering a connectionless-mode service.

3.4.3 Management Architecture

All of the management application modules use the same Messaging Application Programming Interface (MAPI). By unifying management methods with a single MAPI, configuration parameters set using one method (console port, for example) are immediately displayable by the other management methods (for example, SNMP agent of Web browser).

The management architecture of the Switch adheres to the IEEE open standard. This compliance assures customers that the Switch is compatible with, and will interoperate with other solutions that adhere to the same open standard.

4. Web Configuration

The WGSW-24020/WGSW-48040 can be configured through an Ethernet connection, make sure the manager PC must be set on same the IP subnet address with the switch. For example, if you have changed the default IP address of the Switch to 192.168.1.1 with subnet mask 255.255.255.0 via console, then the manager PC should be set at 192.168.1.x (where x is a number between 1 and 253) with subnet mask 255.255.255.0. Or you can use the factory default IP address **192.168.1.254** to do the relative configuration on manager PC. The screen in Figure 4-1 appears.

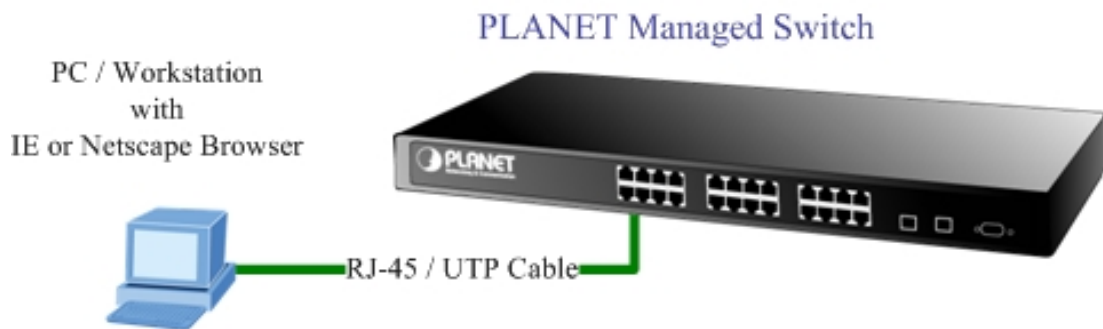

Figure 4-1 Web Management via Ethernet

■ Logging on the switch

1. Use Internet Explorer 5.0 or above Web browser. Enter the factory-default IP address to access the Web interface. The factory-default IP Address as following:

http://192.168.1.254

2. When the following login screen appears, the system will ask you to enter the username and password.

Default User name: **admin**

Default Password: **admin**

The login screen in Figure 4-2 appears.

Notice:

The following section will base on the screens of WGSW-24020, for WGSW-24020 the display will be the same to WGSW-48040.

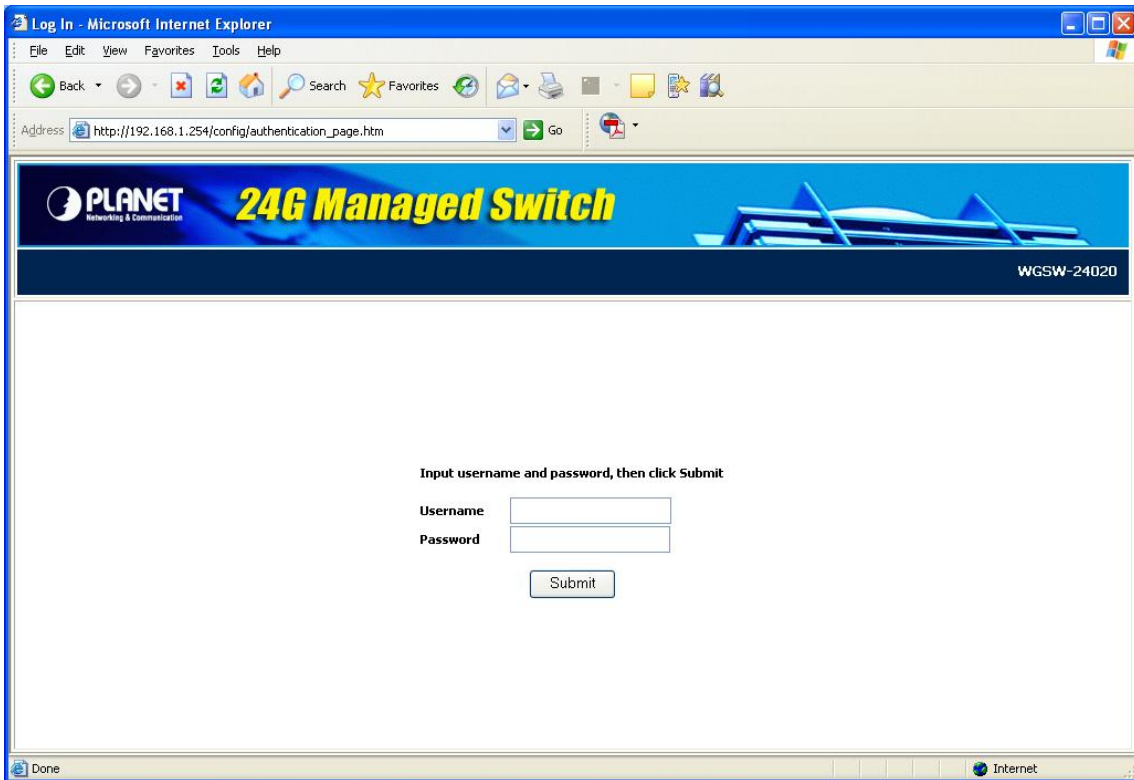

Figure 4-2 Switch Web Login screen

3. After entering the username and password, the main screen appears as Figure 4-3.

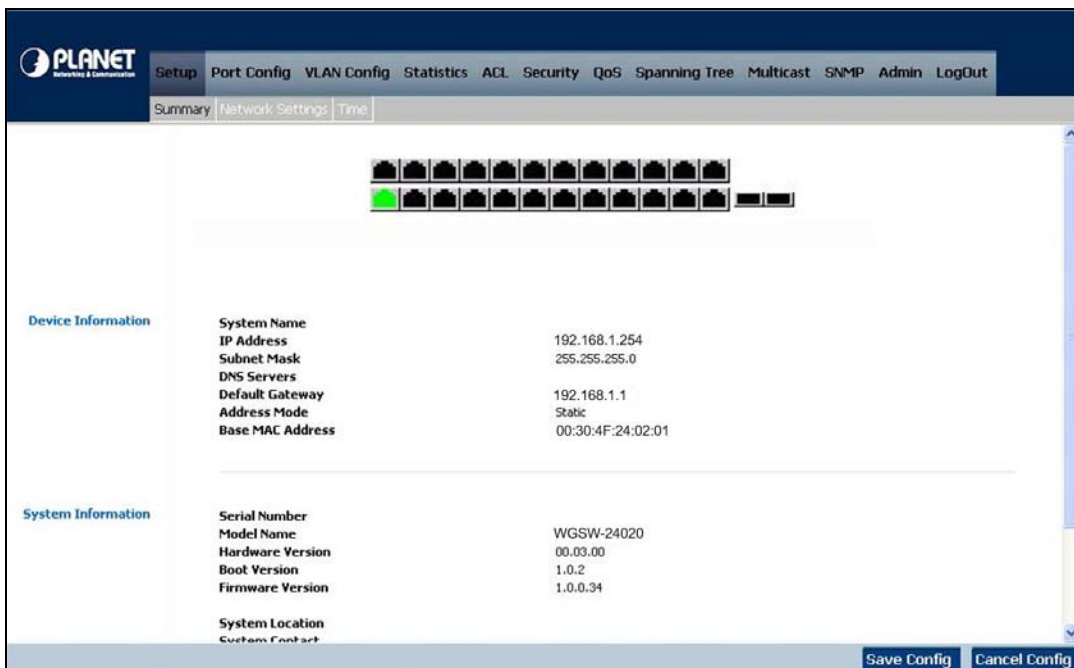

Figure 4-3 Switch Web Main Screen

Now, you can use the Web management interface to continue the Switch management or manage the Switch by console interface.

Notice: It is recommended to use Internet Explore 6.0 or above to access WGSW-Switch.

4.1 Main Screen

The Switch provide Web-based browser interface for configuring and managing the Switch. This interface allows you to access the Switch using the Web browser of your choice. This chapter describes how to use the Switch's Web browser interface to configure and manage the Switch.

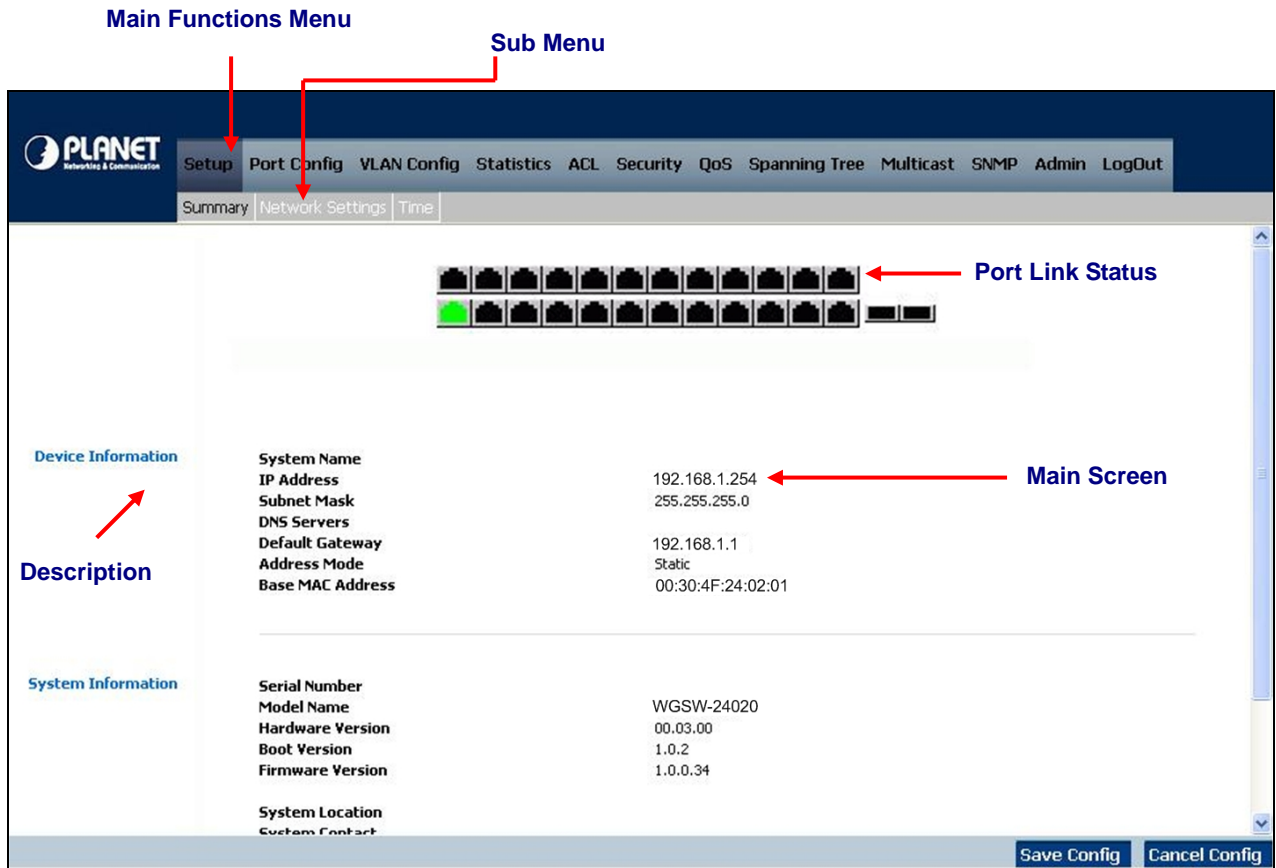

Figure 4-4 Switch Web Main Screen

Save Config

Via the Web-Management, the administrator can setup the WGSW-24020/WGSW-48040 by select the functions those listed in the Main Function. The screen in Figure 4-5 appears.



Figure 4-5 Switch Main Functions Menu

The following functions can be configured here:

- Setup
- Port Config
- VLAN Config
- Statistics
- ACL
- Security
- QoS
- Spanning Tree

- Multicast
- SNMP
- Admin

4.2 Setup

The Setup menus include the tree sub-menus:

- Summary
- Network Settings
- Time

4.2.1 Summary

The summary screen provides Device and System Information about the Switch.

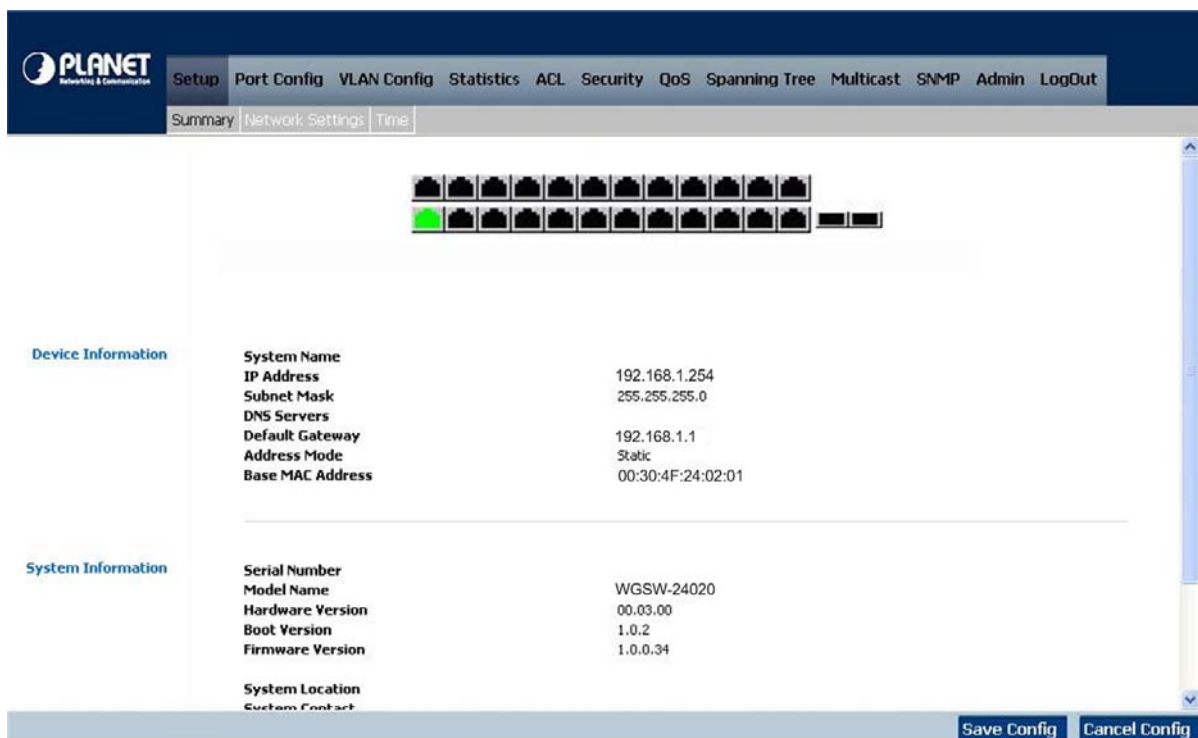

Figure 4-6 Switch System Summary screen

The page contains the following informations:

- **Device Information**

| | |
|------------------------|--|
| System Name | Display the system name. |
| IP Address | Display the current IP address of the device. |
| Subnet Mask | Display the subnet mask address of the device. |
| DNS Servers | Display the current DNS Servers, no matter by manual setting or assigned by the DHCP server. |
| Default Gateway | Display the current default gateway of the device. |

| | |
|-------------------------|---|
| Address Mode | Show the IP Address mode of the system – By Static or Dynamic (DHCP). |
| Base MAC Address | Display the MAC address of the Switch. |

■ **System Information**

| | |
|-------------------------|--|
| Serial Number | The unique box serial number for this Switch. |
| Model Name | The product name of this Switch. |
| Hardware Version | The release version maintenance number of the hardware. |
| Boot Version | The version of boot system currently running on the Switch. |
| Firmware Version | The version of operating system currently running on the Switch. |
| System Location | Display where the Switch is located. |
| System Contact | Display the administrative contact person. |
| System Up Time | The time in days, hours and minutes since the last Switch reboot. |
| Current Time | Specifies the time and date. The format is hour, minute, second, month, day, year. |

]

4.2.2 Network Settings

The Basic Setup Table include the Network Settings (see figure 4-7), which allows you to assign DHCP or static IP settings to interfaces and assign default gateways. In the Networking Setting screen, you can set these parts as below:

Figure 4-7 Switch Network Setting screen

The page includes the following fields:

■ Identification:

| | |
|-------------------------|---|
| System Name | Input the system name. |
| System Location | Input the location where the Switch is located. |
| System Contact | Input the administrative contact person. |
| System Object ID | The system object identifier is in this field. |
| Base MAC Address | Display the MAC address of the Switch. |

■ IP Configuration:

| | |
|------------------------|---|
| Management VLAN | Allow to select the Management VLAN, the default Management VLAN is VLAN 1. |
| IP Address Mode | Where select Static or Dynamic IP address configuration, the Default Mode is Static . |
| Host Name | This field allows input the DHCP Host Name. |
| IP Address | Allow input the IP address for a static address, the default IP Address is 192.168.1.254 . |

| | |
|------------------------|---|
| Subnet Mask | Allow to input the IP subnet mask address, the factory default value is 255.255.255.0 |
| Default Gateway | Allow to input the default gateway address, the factory default value is 0.0.0.0 |
| DNS Server | Allow to input the IP Address for the DNS Server. The Domain Name System (DNS) converts user-defined domain names into IP addresses. |

4.2.3 Time

In the Basic Setup Table, you can see the Time Setup (see figure 4-8), by which you can configure the time settings for the Switch. You can select SNTP Servers: Server1 for the primary SNTP server and Server2 for the secondary SNTP server.

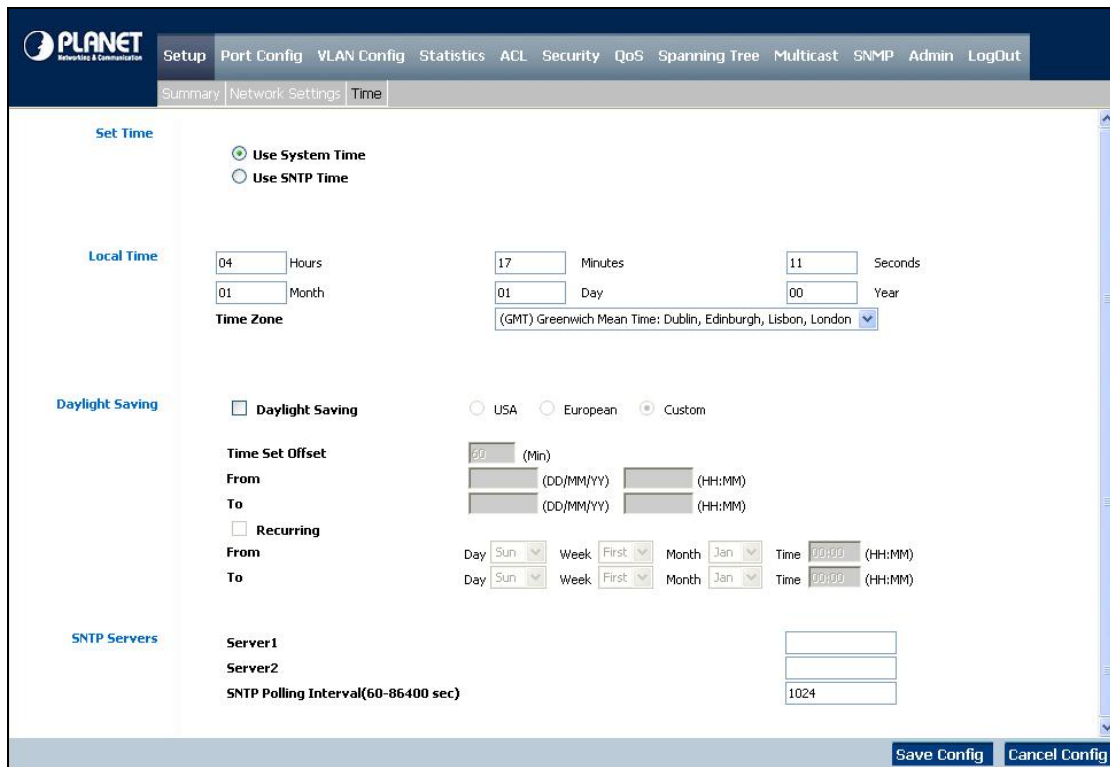

Figure 4-8 Switch Time screen

The Time page includes the following fields:

- **Set Time**

Use System Time Specifies that the system time is not set by an external source but the Local time settings.

Use SNTP Time Specifies that the system time is set via an SNTP server.

- **Local Time**

| | |
|-----------------------------------|---|
| Hours / Minuntes / Seconds | Defines the system time. The field format is HH:MM:SS, for example, 21:15:03. |
| Month / Day / Year | Defines the system date. The field format is Day:Month:Year, for example, 04 May 2007. |
| Time Zone | The difference between Greenwich Mean Time (GMT) and local time. For example, the Time Zone Offset for Paris is GMT +1, while the local time in Taipei is GTM +8. |

■ Daylight Saving

| | |
|------------------------|---|
| Daylight Saving | <p>Enables the Daylight Savings Time (DST) on the device based on the devices location. The possible field values are:</p> <ul style="list-style-type: none"> • USA -- The device switches to DST at 2 a.m. on the first Sunday of April, and reverts to standard time at 2 a.m. on the last Sunday of October. • European -- The device switches to DST at 1:00 am on the last Sunday in March and reverts to standard time at 1:00 am on the last Sunday in October. The European option applies to EU members, and other European countries using the EU standard. • Other -- The DST definitions are user-defined based on the device locality. If Other is selected, the From and To fields must be defined. |
| Time Set Offset | <p>For non USA and European countries, the amount of time for DST can be set in minutes. The value range is (1-1440).</p> <p>The default time is 60 minutes.</p> |
| From | <p>Defines the time that DST begins in countries other than USA or Europe, in the format DayMonthYear in one field and time in another. For example, DST begins on the 25th October 2007 5:00 am, the two fields will be 25Oct07 and 5:00. The possible field values are:</p> <ul style="list-style-type: none"> • Date -- The date at which DST begins. The possible field range is 1-31. • Month -- The month of the year in which DST begins. The possible field range is Jan-Dec. • Year-- The year in which the configured DST begins. • Time -- The time at which DST begins. The field format is Hour:Minute, for example, 05:30. |
| To | <p>Defines the time that DST ends in countries other than USA or European in the format DayMonthYear in one field and time in another. For example, DST ends on the 23rd March 2008 12:00 am, the two fields will be 23Mar08 and 12:00. The possible field values are:</p> <ul style="list-style-type: none"> • Date -- The date at which DST ends. The possible field range is 1-31. • Month -- The month of the year in which DST ends. The possible field range is Jan-Dec. • Year-- The year in which the configured DST ends. • Time -- The time at which DST starts. The field format is Hour:Minute, for example, 05:30. |
| Recurring | <p>Defines the time that DST starts in countries other than USA or Europe where the DST is constant year to year. The possible field values are:</p> |
| From | <p>Defines the time that DST begins each year. For example, DST begins locally every second Sunday in April at 5:00 am. The possible field values are:</p> <ul style="list-style-type: none"> • Day -- The day of the week from which DST begins every year. The possible field range is Sunday-Saturday. • Week -- The week within the month from which DST begins every year. The possible field range is 1-5. • Month -- The month of the year in which DST begins every year. The possible field |

range is Jan.-Dec.

- **Time** -- The time at which DST begins every year. The field format is Hour:Minute, for example, 02:10.

To

Defines the recurring time that DST ends each year. For example, DST ends locally every fourth Friday in October at 5:00 am. The possible field values are:

- **Day** -- The day of the week at which DST ends every year. The possible field range is Sunday-Saturday.
- **Week** -- The week within the month at which DST ends every year. The possible field range is 1-5.
- **Month** -- The month of the year in which DST ends every year. The possible field range is Jan.-Dec.
- **Time** -- The time at which DST ends every year. The field format is Hour:Minute, for example, 05:30.

■ **SNTP Server**

| | |
|---|---|
| Server1 | Enter a user-defined SNTP server IP addresses or hostname. Up to two SNTP servers can be defined. The primary server provides SNTP information. |
| Server2 | The backup server provides SNTP information. |
| Poll Interval (60-86400 sec) | Defines the interval (in seconds) at which the SNTP server is polled for Unicast information. The factory default value is 1024. |



Notice:

The Switch supports the **Simple Network Time Protocol (SNTP)**. SNTP assures accurate network device clock time synchronization up to the millisecond. Time synchronization is performed by a network SNTP server. SNTP operates only as a client, and cannot provide time services to other systems.

4.3 Port Configuration

In this field, you can see these parts, such as port settings, Link aggregation, LACP.

4.3.1 Port settings

To use the port settings screen for setting up each of the switch's ports. It shows these parts: port, description, admin status, link status, speed, duplex, MDI/MDIX, Flow control, type, LAG, PVE (see Figure 4-9):

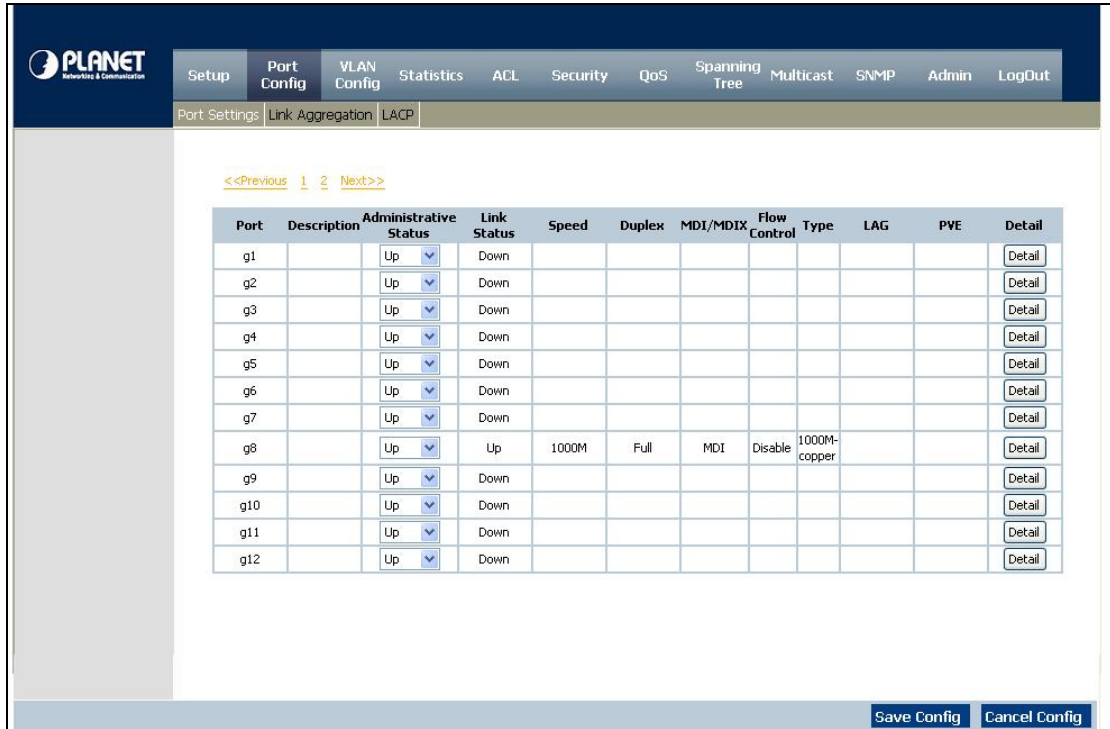

Figure 4-9 Switch Port Settings screen

The Port Settings screen contains the following fields:

| | |
|------------------------------|--|
| Port | Shows the port number. You can click on the Detail button of the appropriate port (G1, G2) to use an SFP module, and the Detail button shows the Port Configuration Detail screen, which include port, description, port type, admin status, current port status |
| Description | Click up the Detail button to make a brief description of the port. |
| Administrative Status | When to choose the UP button, the port can be accessed normally, to choose the Down button, the port will be taken offline. |
| Link Status | Shows an active connection when you choose the UP button, there is no active connection or the port has been taken offline by an Administrator when you choose the Down button. |
| Speed | Shows the connection speed of the port and the speed can be configured only when auto-negotiation is disabled on that port. |
| Duplex | The port duplex mode, Full (transmission occurs in both directions simultaneously) or Half (transmission occurs in only one direction at a time). This mode can be configured only when auto-negotiation is disabled and port speed is set to 10Mbps or 100Mbps. It cannot be configured on Link Aggregation Groups (LAGs). |
| MDI/ MDIX | Shows the MDI/MDIX status of the port. To use the MDI setting if the port is connected to an end station. To use the MDIX setting if the port is connected to a hub or another switch. |
| Flow control | Shows the flow control status of the port. It is active when the port uses Full Duplex Mode. |

| | |
|---------------|---|
| Type | Shows the port type. |
| LAG | Shows whether the port is part of a LAG. |
| PVE | It bypasses the Forwarding Database and forwards all unicast, multicast, and broadcast traffic to an uplink when a port is a Private VLAN Edge (PVE) port, Uplinks can be ports or LAGs. |
| Detail | It will open the port configuration detail screen. |

Click the **Detail** button for more detail port configuration, the **Port Configuration Detail screen** (see figure 4-10)

Figure 4-10 Per Port Configuration detail screen

The Port Configuration screen contains the following fields:

| | |
|----------------------------------|---|
| Port | Indicates the number of each port. |
| Description | Where can be entered by clicking on the Detail button. |
| Port Type | Display the port type of each port. |
| Admin Status | The port can be taken offline by selecting the Down option. When Up is selected, the port can be accessed normally. |
| Current Port Status | Display current status of the each port. |
| Reactivate Suspended Port | To reactivate a port that has been suspended, click the check box. |

| | |
|---------------------------------|--|
| Operational Status | This indicates the port is active or not. |
| Admin Speed | Change the speed of each port. |
| Current Port Speed | Display current speed of each port. |
| Admin Duplex | Change the duplex mode of each port. |
| Current Duplex Mode | Display current duplex mode of each port. |
| Auto Negotiation | Allow enable or disable per port's Auto Negotiation feature. If using an SFP module, Auto Negotiation for the specific port should be set to disable. |
| Current Auto Negotiation | Display current setting of the port's Auto Negotiation status. |
| Admin Advertisement | Specifies the capabilities to be advertised by the port. Multiple options may be selected or Max Capability can be selected to cover all of the options. The available options are: <ul style="list-style-type: none"> Max Capability, which indicates that the port speeds and duplex mode settings can be accepted. 10 Half, indicates that the port is advertising a 10Mbps half duplex mode setting. 10 Full indicates that the port is advertising a 10Mbps full duplex mode setting. 100 Half, indicates that the port is advertising a 100Mbps half duplex mode setting. 100 Full indicates that the port is advertising a 100Mbps full duplex mode setting. 1000 Full, indicates that the port is advertising a 1000Mbps full duplex mode setting. |
| Current Advertisement | The port advertises its capabilities to its neighbor port to begin the negotiation process. This field displays the current advertisement settings. |
| Neighbor Advertisement | The neighbor port (the port to which the selected interface is connected) advertises its capabilities to the port to start the negotiation process. This field displays the neighbor's current settings. |
| Back Pressure | The Back Pressure feature of the selected port can be enabled or disabled . |
| Current Back Pressure | Displays whether Back Pressure is enabled or disabled on the currently selected port |
| Flow Control | The Flow Control feature of the selected port can be enabled or disabled . |
| Current Flow Control | Displays whether Flow Control is enabled or disabled on the currently selected port. |
| MDI/ MDIX | <ul style="list-style-type: none"> • Auto - the port to automatically detect the cable type. • MDI - if the port is connected to an end station. • MDIX - if the port is connected to a hub or another switch |
| Current MDI/MDIX | Display the current MDI/MDIX status on each port. |
| PVE | For Gigabit Ethernet switches ONLY. When a port is a Private VLAN Edge (PVE) port, it bypasses the Forwarding Database and forwards all unicast, multicast, and broadcast traffic to an uplink. Uplinks can be ports or LAGs. |

After setup complete, please click the **Save** button to save your changes.

4.3.2 Link Aggregation

When you enter the Link Aggregation, the screen appears in figure 4-11, such as: LAG, shows whether the port is part of a LAG.

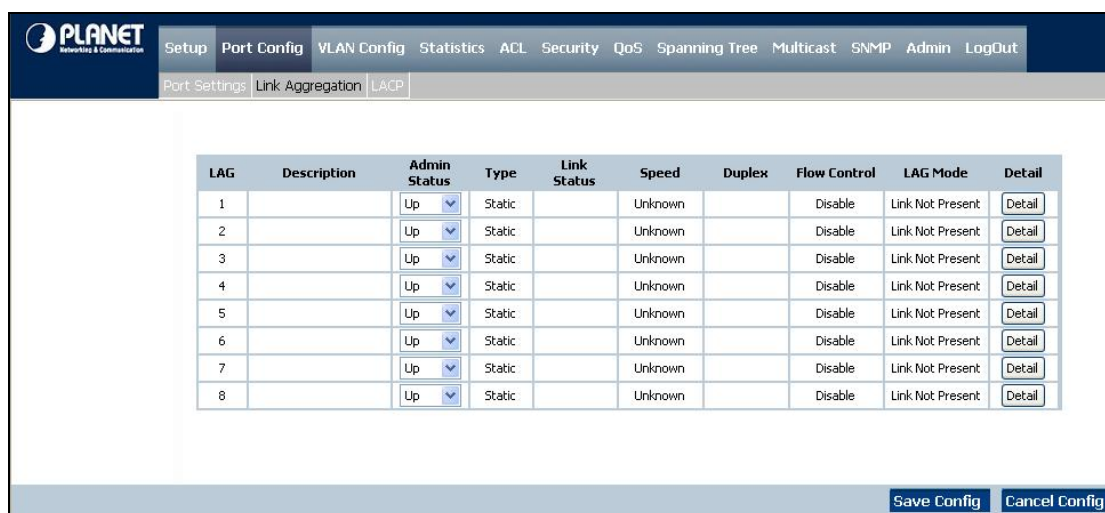

Figure 4-11 Switch Link Aggregation screen

The Link Aggregation page contains the following fields:

| | |
|---------------------|--|
| LAG | Indicates the number of the LAG interface. Up to eight LAG interfaces can be configured. |
| Description | Indicates the description of the LAG ports. |
| Admin Status | Up indicates that the port is available and down shows administrator has taken the port offline. after setup completed, please click the Save Settings option to save current setting. |
| Type | The port types that comprise the LAG. |
| Link Status | Shows an active connection when you choose the UP button, there is no active connection or the port has been taken offline by an Administrator when you choose the Down button. |
| Speed | Shows the connection speed on each port and the speed can be configured only when auto-negotiation is disabled on that port. |
| Duplex | The port duplex mode, Full (transmission occurs in both directions simultaneously) or Half (transmission occurs in only one direction at a time). This mode can be configured only when auto-negotiation is disabled and port speed is set to 10Mbps or 100Mbps. |
| Flow control | Shows the flow control status of the port. It is active when the port runs at Full Duplex Mode. |
| LAG Mode | Shows the current mode of the LAG interface. |

Click the **Detail** button for more detail port configuration.

■ Link Aggregation detail configuration

At per-LAG detail configuration page, the administrator can select ports to be the members of the LAG interface. The screen

appears as follow:

Link Aggregation

LAG Configuration

LAG:

Description:

LACP:

LAG Type:

Administrative Status:

Current Status:

Reactivate Suspended LAG:

Operational Status:

Admin Auto Negotiation:

Current Auto Negotiation:

Admin Speed:

Current LAG Speed:

Admin Flow Control:

Current Flow Control:

PVE:

Select Ports

g1 g2 g3 g4 g5 g6 g7 g8 g9 g10 g11 g12 g13 g14 g15 g16 g17 g18 g19 g20 g21 g22 g23 g24

Port:

Figure 4-12 Switch per Link Aggregation screen

4.3.3 LACP

Aggregated Links can be manually setup or automatically established on the relevant links by enabling Link Aggregation Control Protocol (LACP). Aggregate ports can be linked into link-aggregation port-groups. Each group is comprised of ports with the same speed, set to full-duplex operation, the LACP screen contains fields for configuring LACP LAGs (see figure 4-13).

PLANET
Networking & Communication

[Setup](#) | [Port Config](#) | [VLAN Config](#) | [Statistics](#) | [ACL](#) | [Security](#) | [QoS](#) | [Spanning Tree](#) | [Multicast](#) | [SNMP](#) | [Admin](#) | [LogOut](#)

[Port Settings](#) | [Link Aggregation](#) | [LACP](#)

System Priority

LACP System Priority (1-65535):

Port Priority

Port:

LACP Port Priority:

LACP Timeout:

Admin Key:

LACP Port Table

<<Previous 1 2 Next>>

| | Port | Admin Key | Port-Priority | LACP Timeout |
|----|------|-----------|---------------|--------------|
| 1 | g1 | 0 | 1 | Long |
| 2 | g2 | 0 | 1 | Long |
| 3 | g3 | 0 | 1 | Long |
| 4 | g4 | 0 | 1 | Long |
| 5 | g5 | 0 | 1 | Long |
| 6 | g6 | 0 | 1 | Long |
| 7 | g7 | 0 | 1 | Long |
| 8 | g8 | 0 | 1 | Long |
| 9 | g9 | 0 | 1 | Long |
| 10 | g10 | 0 | 1 | Long |
| 11 | g11 | 0 | 1 | Long |
| 12 | g12 | 0 | 1 | Long |

Figure 4-13 Switch LACP configuration screen

The page contains the following fields:

| | |
|-----------------------------|---|
| LACP System Priority | Indicates the global LACP priority value. The possible range is 1- 65535 and the default value is 1. |
| Port | Set the port number which need to timeout and the priority values are assigned. |
| LACP Port Priority | Where set the LACP priority value for the port and the field range is 1-65535. |
| LACP Timeout | Administrative LACP timeout. A short or long timeout value can be selected. Long is the default. |
| Admin Key | A channel will only be formed between ports having the same admin key, in other words, this only applies to ports located on the same switch. |

4.4 VLAN Configuration

A Virtual LAN (VLAN) is a logical network grouping that limits the broadcast domain. It allows you to isolate network traffic so only members of the VLAN receive traffic from the same VLAN members. Basically, creating a VLAN from a switch is logically equivalent of reconnecting a group of network devices to another Layer 2 switch. However, all the network devices are still plug into the same switch physically.

The Switch supports IEEE 802.1Q (tagged-based) and GVRP Dynamic VLAN setting in web management page. In the default configuration, VLAN support is “**802.1Q**”.

IEEE 802.1Q VLANs

IEEE 802.1Q (tagged) VLAN are implemented on the Switch. 802.1Q VLAN require tagging, which enables them to span the entire network (assuming all switches on the network are IEEE 802.1Q-compliant).

VLAN allow a network to be segmented in order to reduce the size of broadcast domains. All packets entering a VLAN will only be forwarded to the stations (over IEEE 802.1Q enabled switches) that are members of that VLAN, and this includes broadcast, multicast and unicast packets from unknown sources.

VLAN can also provide a level of security to your network. IEEE 802.1Q VLAN will only deliver packets between stations that are members of the VLAN. Any port can be configured as either tagging or untagging. The untagging feature of IEEE 802.1Q VLAN allows VLAN to work with legacy switches that don't recognize VLAN tags in packet headers. The tagging feature allows VLAN to span multiple 802.1Q-compliant switches through a single physical connection and allows Spanning Tree to be enabled on all ports and work normally.

Any port can be configured as either tagging or untagging. The untagging feature of IEEE 802.1Q VLAN allows VLAN to work with legacy switches that don't recognize VLAN tags in packet headers. The tagging feature allows VLAN to span multiple 802.1Q-compliant switches through a single physical connection and allows Spanning Tree to be enabled on all ports and work normally.

| Frame Income Frame Leave | Income Frame is tagged | Income Frame is untagged |
|-----------------------------|-------------------------------|---------------------------------|
| Leave port is tagged | Frame remains tagged | Tag is inserted |
| Leave port is untagged | Tag is removed | Frame remain untagged |

In this field, there are five items, such as Create VLAN, Port setting, Ports to VLAN, VLAN to Ports, GVRP.

4.4.1 Create VLAN

In this table, the information and global parameters for configuring and working with VLAN s will be provided (see figure 4-14).

The screenshot shows the 'VLAN Config' page in the Planet Network & Communication web interface. The page has a navigation menu at the top with options like Setup, Port Config, VLAN Config, Statistics, ACL, Security, QoS, Spanning Tree, Multicast, SNMP, Admin, and LogOut. Below the menu, there are sub-tabs: Create VLAN, Port Setting, Ports to VLAN, VLAN to Ports, and GVRP. The 'Create VLAN' sub-tab is active. On the left, there are three sections: 'Single VLAN', 'VLAN Range', and 'VLAN Table'. The 'Single VLAN' section has input fields for 'VLAN ID (2-4094):' and 'VLAN Name:', and an 'Add' button. The 'VLAN Range' section has input fields for 'VLAN Range:' and an 'Add Range' button. The 'VLAN Table' section contains a table with the following data:

| VLAN ID | VLAN NAME | Status |
|---------|-----------|---------|
| 1 | | Default |
| 2 | VLAN_2 | Static |
| 3 | VLAN_3 | Static |

Below the table is a 'Remove' button. At the bottom of the page, it says 'Total existing VLANs: 1' and has 'Save Config' and 'Cancel Config' buttons.

Figure 4-14 Switch Create VLAN screen

The page contains the following fields:

■ Single VLAN

| | |
|-------------------------|---|
| VLAN ID (2-4094) | You can configure the ID number of the VLAN by this item. Up to 256 VLANs can be created. This field is used to add VLANs one at a time. If you want to add the defined VLAN ID number, you can press the Add button. |
| VLAN Name | Where shows the user-defined VLAN name. |
| VLAN Range | Indicates a range of VLANs configured. To add the defined range of VLAN ID numbers, press the Add Range button. |

■ VLAN Table

The VLAN Table displays a list of all configured VLANs, include the

- **VLAN ID,**
- **VLAN Name,**
- **Status**

To remove a VLAN, click the **Remove** button.

4.4.2 Port setting

In this port setting screen (refer to figure 4-15), the parameters managing ports that are part of a VLAN will be provided, and you can set the default VLAN ID (PVID). All untagged packets arriving to the device are tagged by the ports PVID.

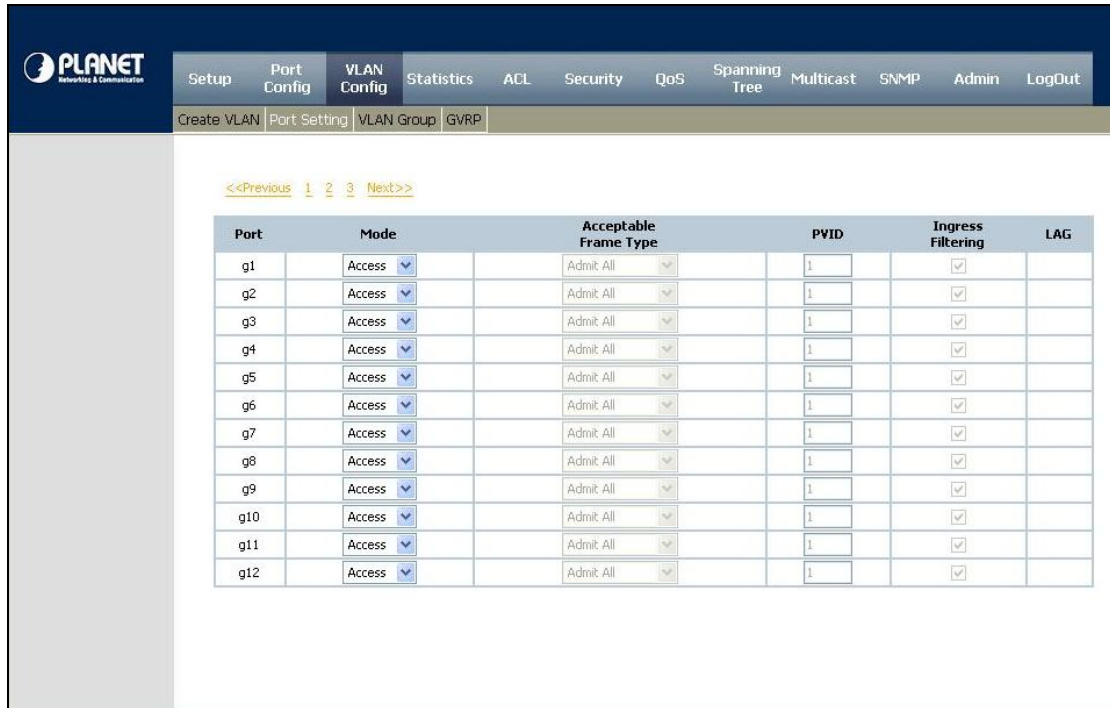

Figure 4-15 VLAN Port Setting screen

The page contains the following fields:

| | |
|------------------------------|--|
| Port | Displays the port number included in the VLAN. |
| Mode | Indicates the port mode. Possible values are: <ul style="list-style-type: none"> • General - The port belongs to VLANs, and each VLAN is user-defined as tagged or untagged (full 802.1Q mode). • Access - The port belongs to a single untagged VLAN. When a port is in Access mode, the packet types which are accepted on the port (packet type) cannot be designated. It is also not possible to enable/ disable ingress filtering on an access port. • Trunk - The port belongs to VLANs in which all ports are tagged (except for an optional single native VLAN). |
| Acceptable Frame Type | Packet type accepted on the port. Possible values are: <ul style="list-style-type: none"> • Admit Tag Only - indicates that only tagged packets are accepted on the port. • Admit All - indicates that both tagged and untagged packets are accepted on the port. |
| PVID | Assigns a VLAN ID to untagged packets. The possible values are 2 to 4094. VLAN 4095 is defined as per standard and industry practice as the discard VLAN. Packets classified to the Discard VLAN are dropped. |
| Ingress Filtering | Enables or disables Ingress filtering on the port. Ingress filtering discards packets which do not include an ingress port. |
| LAG | Indicates the LAG to which the VLAN is defined. |

| Port Mode | VLAN Membership | Frame Leave |
|-----------|---|--|
| Access | Belongs to a single untagged VLAN | Untagged (Tag=PVID be removed) |
| General | Allowed to belongs to multiple untagged VLANs at the same time | Untagged (Tag=PVID be removed) |
| Trunk | Allowed to belongs to multiple Tagged VLANs at the same time | Tagged (Tag=PVID or Original VID be remained) |

4.4.3 Ports to VLAN

The Ports to VLAN screen contains fields for configuring ports to a VLAN. The port default VLAN ID (PVID) is configured on the Create VLAN screen. All untagged packets arriving to the device are tagged by the ports PVID. The Ports to VLAN screen contains a Port Table for VLAN parameters for each port. Ports are assigned VLAN membership by selecting and configuring the presented configuration options, please refer to figure 4-16.

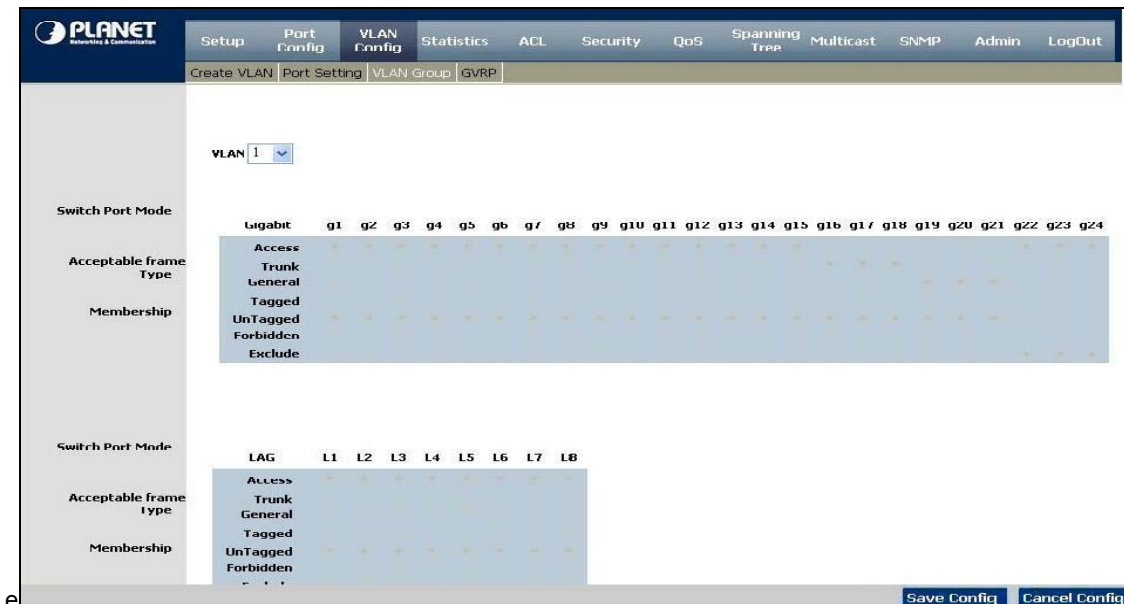

Figure 4-16 Ports to VLAN screen

The page contains the following fields:

| | |
|------------------|--|
| VLAN | Where means the VLAN number. |
| Access | Indicates the port belongs to a single untagged VLAN. When a port is in Access mode, the packet types which are accepted on the port cannot be designated. Ingress filtering cannot be enabled/disabled on an access port. |
| Trunk | Which indicates the port belongs to VLANs in which all ports are tagged, except for one port that can be untagged. |
| General | Which indicates the port belongs to VLANs, and each VLAN is user-defined as tagged or untagged (full 802.1Q mode). |
| Tagged | Defines the interface as a tagged member of a VLAN. All packets forwarded by the interface are tagged. The packets contain VLAN information. |
| Untagged | Packets forwarded by the interface are untagged. |
| Forbidden | Forbidden ports are not included in the VLAN. |
| Exclude | Excludes the interface from the VLAN. However, the interface can be added to the VLAN through GVRP. |

4.4.4 GVRP

GARP VLAN Registration Protocol (GVRP) is specifically provided for automatic distribution of VLAN membership information among VLAN-aware bridges. GVRP allows VLAN-aware bridges to automatically learn VLANs to bridge ports mapping, without having to individually configure each bridge and register VLAN membership. The Global System LAG information displays the same field information as the ports, but represents the LAG GVRP information. The GVRP screen (refer to 4-17) is divided into two areas, GVRP and GVRP Table. The field definitions for both areas are the same.

The screenshot shows the GVRP configuration interface. At the top, there is a navigation bar with tabs for Setup, Port Config, VLAN Config, Statistics, ACL, Security, QoS, Spanning Tree, Multicast, SNMP, Admin, and LogOut. Below this is a sub-menu with options: Create VLAN, Port Setting, Ports to VLAN, VLAN to Ports, and GVRP. The main configuration area has the following fields:

- Enable GVRP:**
- Interface:** Port: e1 LAG
- GVRP State:**
- Dynamic VLAN Creation:**
- GVRP Registration:**

An **Update** button is located below the checkboxes. Below the configuration fields is the **GVRP Table** section, which includes navigation links: <<Previous | 1 | 2 | Next>>. The table has the following data:

| Interface | GVRP State | Dynamic VLAN Creation | GVRP Registration |
|-----------|------------|-----------------------|-------------------|
| e1 | Disabled | Enabled | Enabled |
| e2 | Disabled | Enabled | Enabled |
| e3 | Disabled | Enabled | Enabled |
| e4 | Disabled | Enabled | Enabled |
| e5 | Disabled | Enabled | Enabled |
| e6 | Disabled | Enabled | Enabled |
| e7 | Disabled | Enabled | Enabled |
| e8 | Disabled | Enabled | Enabled |
| g1 | Disabled | Enabled | Enabled |
| g2 | Disabled | Enabled | Enabled |

At the bottom right of the screen are **Save Config** and **Cancel Config** buttons.

Figure 4-17 GVRP configuration screen

The page contains the following fields:

| | |
|------------------------------|---|
| Enable GVRP | Enables and disables GVRP on the device. |
| Interface | Displays the interface on which GVRP is enabled. Possible field values are: Port - indicates the port number on which GVRP is enabled. LAG - indicates the LAG number on which GVRP is enabled. |
| GVRP State | When the checkbox is checked, GVRP is enabled on the interface. |
| Dynamic VLAN Creation | When the checkbox is checked, Dynamic VLAN creation is enabled on the interface. |
| GVRP Registration | When the checkbox is checked, VLAN registration through GVRP is enabled on the device. |
| Update | The Update button adds the configured GVRP setting to the table at the bottom of the screen. |

4.5 Statistics

The Statistic of the switch, this field includes these parts as below:

4.5.1 RMON Statistics

The RMON Statistics screen (refer to figure 4-18) contains fields for viewing information about device utilization and errors that occurred on the device.

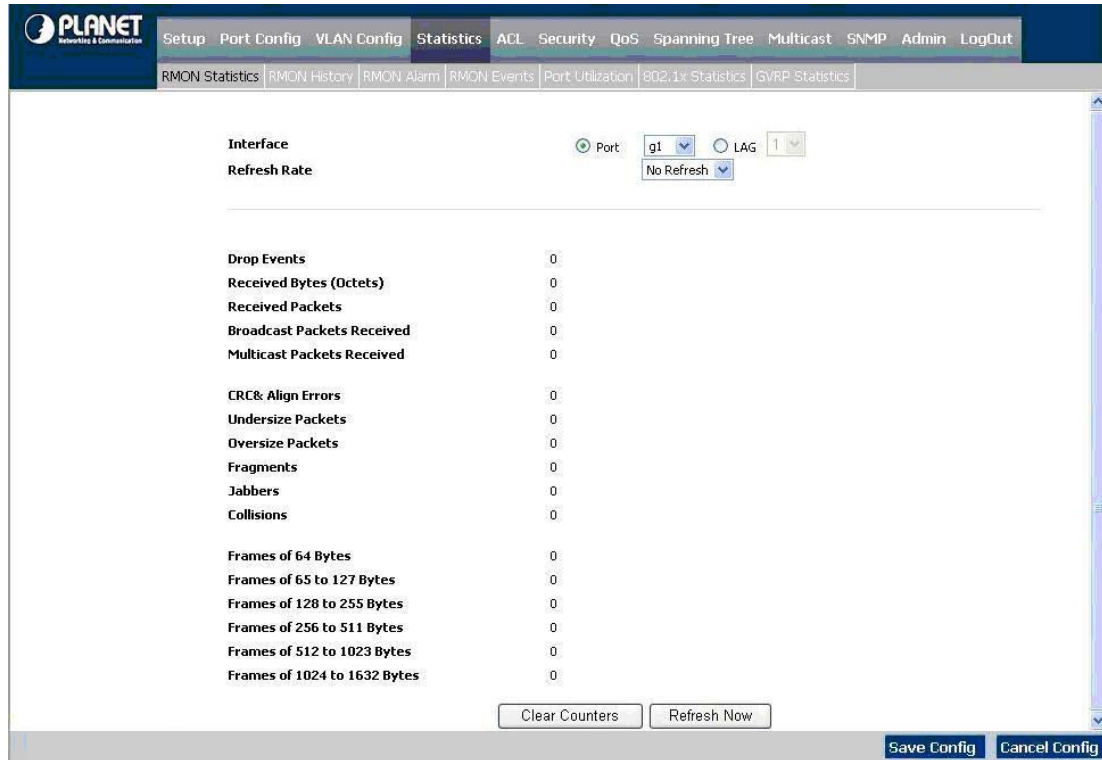

Figure 4-18 RMON Statistics screen

The page contains the following fields:

| | |
|-----------------------------------|--|
| Interface | Indicates the device for which statistics are displayed. The possible field values are: <ul style="list-style-type: none"> • Port - defines the specific port for which RMON statistics are displayed. • LAG - defines the specific LAG for which RMON statistics are displayed. |
| Refresh Rate | Defines the amount of time that passes before the interface statistics are refreshed. The possible field values are: <ul style="list-style-type: none"> • No Refresh, indicates that the RMON statistics are not refreshed. • 15 Sec, which indicates that the RMON statistics are refreshed every 15 seconds. • 30 Sec, which indicates that the RMON statistics are refreshed every 30 seconds. • 60 Sec, which indicates that the RMON statistics are refreshed every 60 seconds. |
| Drop Events | which displays the number of dropped events that have occurred on the interface since the device was last refreshed. |
| Received Bytes (Octets) | Displays the number of octets received on the interface since the device was last refreshed. This number includes bad packets and FCS octets, but excludes framing bits. |
| Received Packets | Displays the number of packets received on the interface, including bad packets, Multicast and broadcast packets, since the device was last refreshed. |
| Broadcast Packets Received | Which displays the number of good broadcast packets received on the interface since the device was last refreshed. This number does not include Multicast packets. |
| Multicast Packets Received | Displays the number of good Multicast packets received on the interface since the device was last refreshed. |
| CRC & Align Errors | which displays the number of CRC and Align errors that have occurred on the interface since the device was last refreshed. |
| Undersize Packets | Displays the number of undersized packets (less than 64 octets) received on the interface since the device was last refreshed. |
| Oversize Packets | Displays the number of oversized packets (over 1518 octets) received on the interface since the device was last refreshed. |

- Fragments** Indicates the number of fragments (packets with less than 64 octets, excluding framing bits, but including FCS octets) received on the interface since the device was last refreshed.
- Jabbers** Indicates the total number of received packets that were **longer than 1518 octets**. This number excludes frame bits, but includes FCS octets that had either a bad Frame Check Sequence (FCS) with an integral number of octets (FCS Error) or a bad FCS with a non-integral octet (Alignment Error) number. The field range to detect jabbers is between 20 ms and 150 ms.
- Collisions** Displays the number of collisions received on the interface since the device was last refreshed.
- Frames of xx Bytes** Number of xx-byte frames received on the interface since the device was last refreshed. Clear Counters button, this option will reset all of the statistic counts. Refresh Now button, which use this option to refresh the statistics.

4.5.2 RMON History

The RMON History contains information about samples of data taken from ports. For example, the samples may include interface definitions or polling periods. The RMON History Control screen is divided into **RMON History** and **Log Table**. Log Table includes the following parts (see figure 4-19).

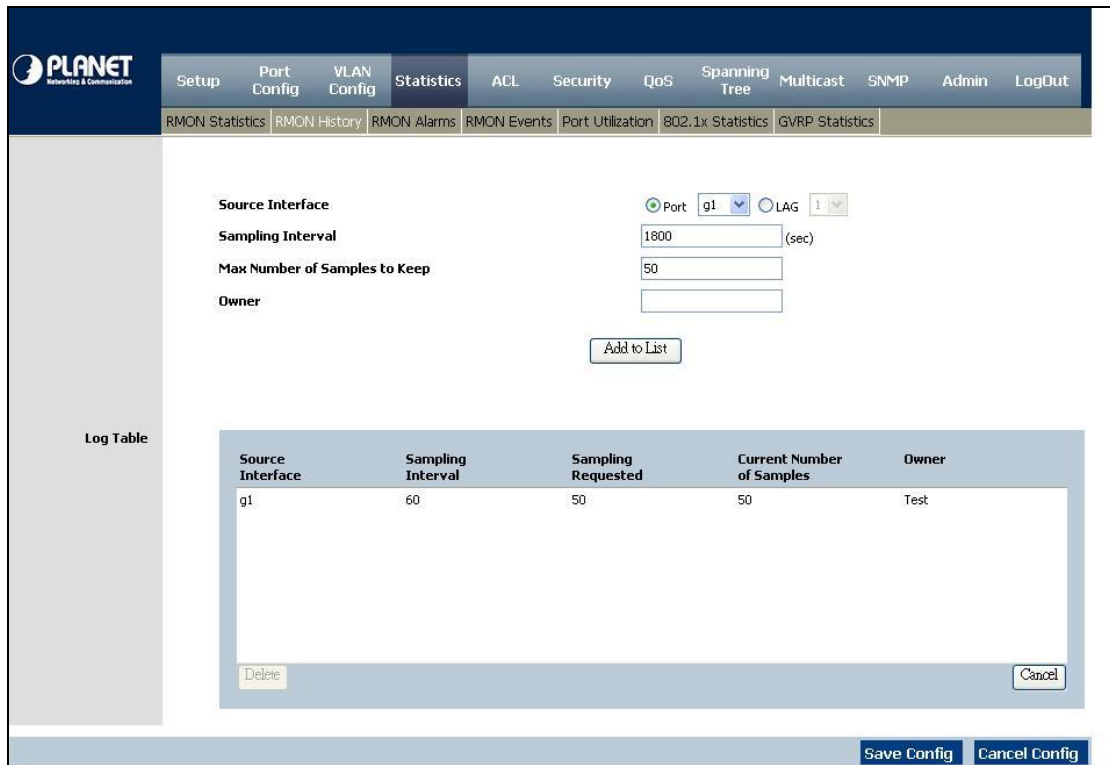

Figure 4-19 RMON History screen

The page contains the following fields:

■ **RMON History**

| | |
|------------------------------------|---|
| • Source Interface | Displays the interface from which the history samples were taken. The possible field values are: Port , specifies the port from which the RMON information was taken. LAG , specifies the port from which the RMON information was taken. |
| • Sampling Interval | Indicates (in seconds) the time that samplings are taken from the ports. The field range is 1-3600. The default is 1800 seconds (equal to 30 minutes) |
| • Sampling Requested | Displays the number of samples to be saved. The field range is 1-65535. The default value is 50 . |
| • Current Number of Samples | Displays the current number of samples taken. View History button. This button opens the RMON History screen. |
| • Owner | Where displays the RMON station or user that requested the RMON information. The field range is 0-20 characters. |

Use the **Add to List** button when you add the configured RMON sampling to the Log Table at the bottom of the screen

■ **RMON History Table**

The RMON History screen (see figure 4-20) contains interface specific statistical network samplings. Each table entry represents all counter values compiled during a single sample.

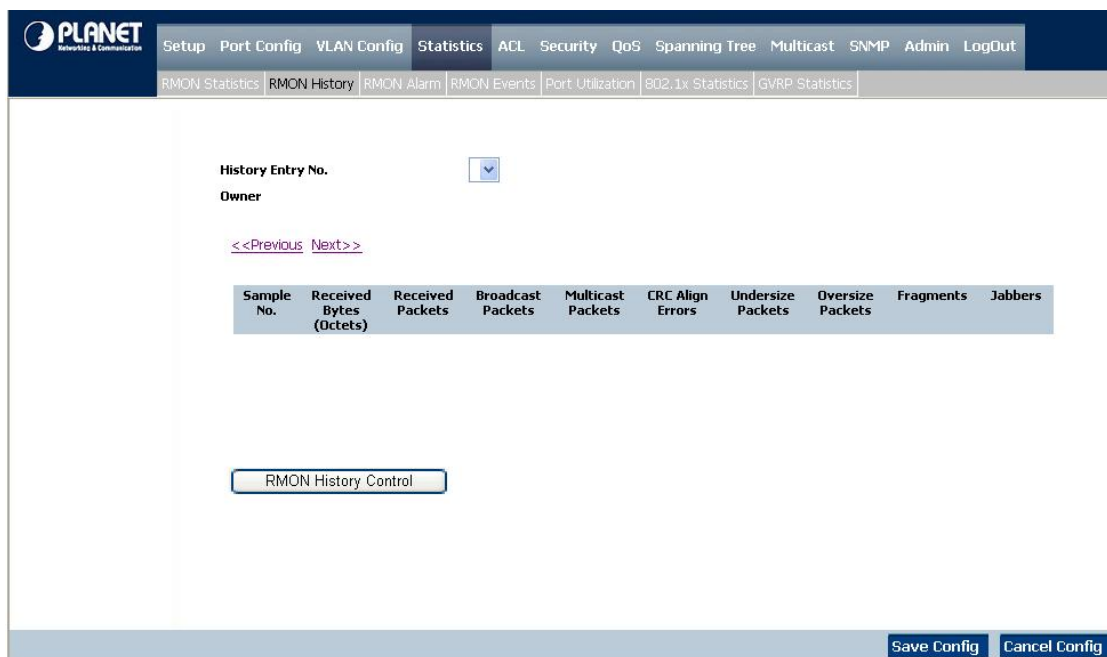

Figure 4-20 RMON History Table screen

The page contains the following fields:

| | |
|--------------------------------|--|
| Sample No | Indicates the sample number from which the statistics were taken. |
| Received Bytes (Octets) | Displays the number of octets received on the interface since the device was last refreshed. This number includes bad packets and FCS octets, but excludes framing bits. |
| Received Packets | Displays the number of packets received on the interface since the device was last refreshed, including bad packets, Multicast and Broadcast packets. |
| Broadcast Packets | Displays the number of good Broadcast packets received on the interface since the device was last refreshed. This number does not include Multicast packets. |
| Multicast Packets | Displays the number of good Multicast packets received on the interface since the device was last refreshed. |
| CRC Align Errors | Which displays the number of CRC and Align errors that have occurred on the interface since the device was last refreshed. |
| Undersize Packets | Displays the number of undersized packets (less than 64 octets) received on the interface since the device was last refreshed. |
| Oversize Packets | Displays the number of oversized packets (over 1518 octets) received on the interface since the device was last refreshed. |
| Fragments | Displays the number of fragments (packets with less than 64 octets, excluding framing bits, but including FCS octets) received on the interface since the device was last refreshed. |
| Jabbers | Displays the total number of received packets that were longer than 1518 octets. This number excludes frame bits, but includes FCS octets that had either a bad Frame Check Sequence (FCS) with an integral number of octets (FCS Error) or a bad FCS with a non-integral octet (Alignment Error) number. The field range to detect jabbers is between 20 ms and 150 ms. |

4.5.3 RMON Alarm

The RMON Alarm screen (see figure 4-21) contains fields for setting network alarms. Network alarms occur when a network problem, or event, is detected. Rising and falling thresholds generate events.

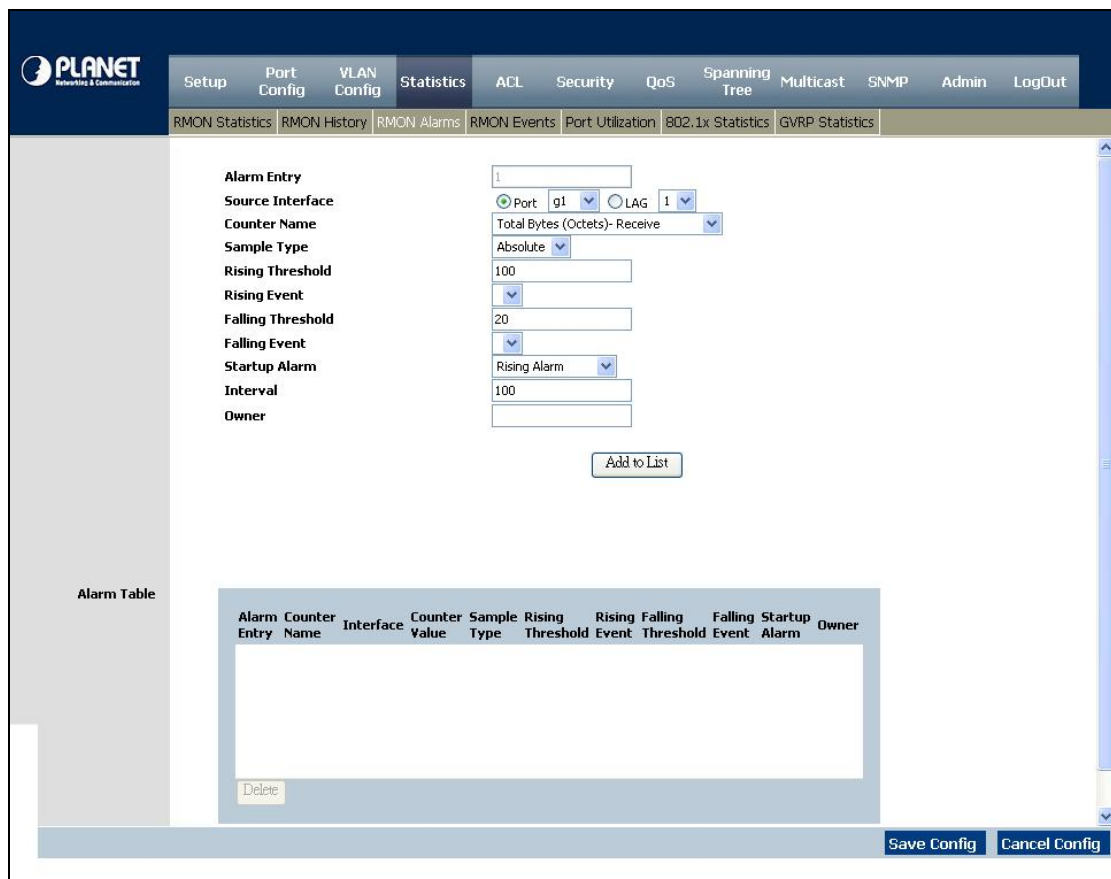

Figure 4-21 RMON Alarm screen

The page contains the following fields:

| | |
|--------------------------|--|
| Alarm Entry | Indicates a specific alarm. |
| Source Interface | Displays the interface for which RMON statistics are displayed. The possible field values are: <ul style="list-style-type: none"> • Port, displays the selected port of the RMON statistics. • LAG, displays the RMON statistics for the selected LAG. |
| Counter Name | Displays the selected MIB variable. |
| Sample Type | Defines the sampling method for the selected variable and comparing the value against the thresholds. The possible field values are: <ul style="list-style-type: none"> • Absolute, compares the values directly with the thresholds at the end of the sampling interval. • Delta, subtracts the last sampled value from the current value. The difference in the values is compared to the threshold. |
| Rising Threshold | Displays the rising counter value that triggers the rising threshold alarm. The rising threshold is presented on top of the graph bars. Each monitored variable is designated a color. |
| Rising Event | Displays the mechanism in which the alarms are reported. The possible field values are: <ul style="list-style-type: none"> • LOG. Indicates there is not a saving mechanism for either the device or in the management system. If the device is not reset, the entry remains in the Log Table. • TRAP, indicates that an SNMP trap is generated, and sent via the Trap mechanism. The Trap can also be saved using the Trap mechanism. • Both, indicates that both the Log and Trap mechanism are used to report alarms. |
| Falling Threshold | Displays the falling counter value that triggers the falling threshold alarm. The falling threshold is graphically presented on top of the graph bars. Each monitored variable is designated a color. |
| Falling Event | Displays the mechanism in which the alarms are reported. The possible field values are: <ul style="list-style-type: none"> • LOG, indicates there is not a saving mechanism for either the device or in the management system. If the device is not reset, the entry remains in the Log Table. • TRAP, indicates that a SNMP trap is generated, and sent via the Trap mechanism. The Trap can also be saved using the Trap mechanism. • Both, indicates that both the Log and Trap mechanism are used to report alarms. |
| Startup Alarm | Displays the trigger that activates the alarm generation. Rising is defined by crossing the threshold from a low-value threshold to a higher-value threshold. |
| Interval | Defines the alarm interval time in seconds. |
| Owner | Where displays the device or user that defined the alarm. |

Use the **Add to List** button when you add the RMON Alarms Table entry.

4.5.4 RMON Events

The RMON Events screen (see figure 4-22) contains fields for defining RMON events.

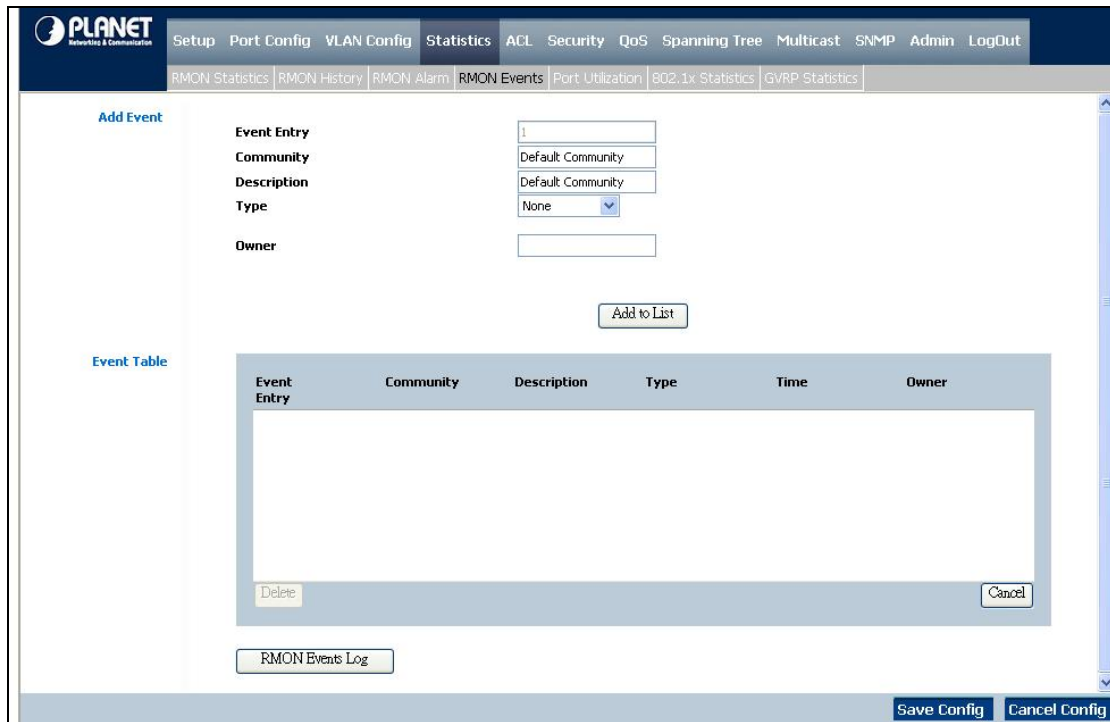

Figure 4-22 RMON Event screen

The page contains the following fields:

■ **Add Event:**

| | |
|--------------------|--|
| Event Entry | Displays the event. |
| Community | where displays the community to which the event belongs. |
| Description | Displays the user-defined event description. |
| Type | Describes the event type. Possible values are: <ul style="list-style-type: none"> • None, where indicates that no event occurred. • Log, indicates that the event is a log entry. • Trap, indicates that the event is a trap. • Log and Trap, indicates that the event is both a log entry and a trap. |
| Owner | Where displays the device or user that defined the event. Use the Add to List button when you add the configured RMON event to the Event Table at the bottom of the screen (see figure 4-21). |

The **Event Table** area contains the following additional field:

| | |
|-------------|---|
| Time | Where displays the time that the event occurred |
|-------------|---|

Press the **RMON Event Log** button to display the log store in the flash. Only the Event type is Log or Log and Trap, then the entries appear. The screen in Figure 4-23 appears.

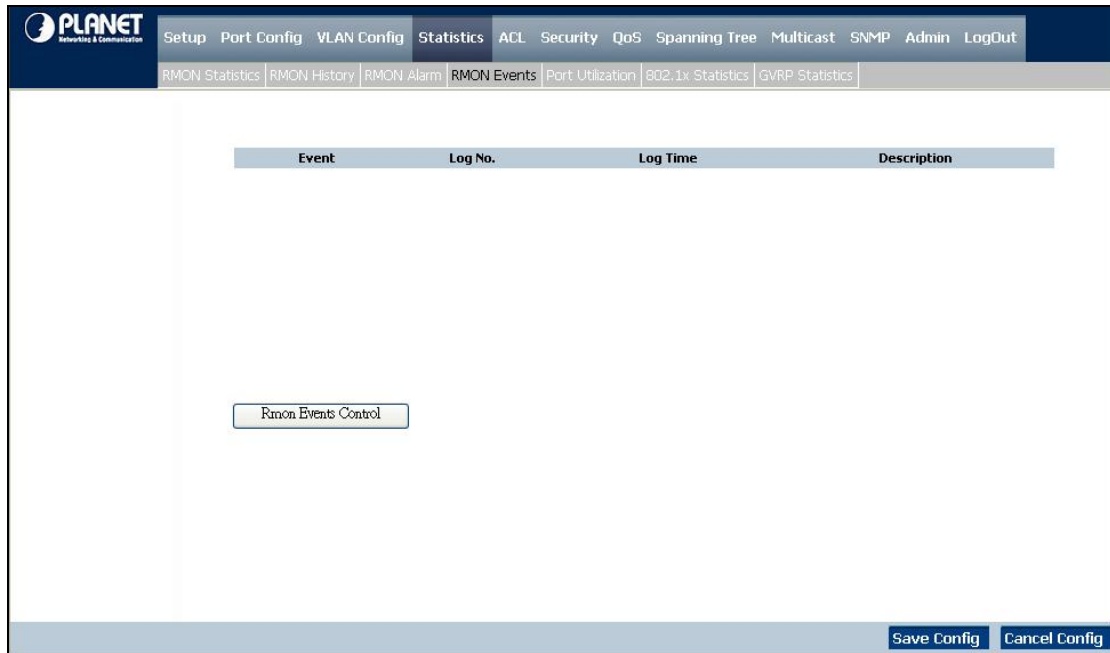

Figure 4-23 RMON Event Log Screen

4.5.5 Port Utilization

The Port Utilization screen (see figure 4-24) indicates the amount of resources each interface is currently consuming. Ports in green are functioning normally, while ports in red are currently transmitting an excessive amount of network traffic.



Figure 4-24 Port Utilization screen

The page includes the following fields:

Refresh Rate Indicates the amount of time that passes before the port utilization statistics are refreshed. The possible field values are:

- **No Refresh** - indicates that the statistics are not refreshed.
- **15 Sec** - indicates that the statistics are refreshed every 15 seconds.
- **30 Sec** - indicates that the statistics are refreshed every 30 seconds.
- **60 Sec** - indicates that the statistics are refreshed every 60 seconds.

4.5.6 802.1x Statistics

The 802.1X Statistics screen (see figure 4-25) contains information about EAP packets received on a specific port.

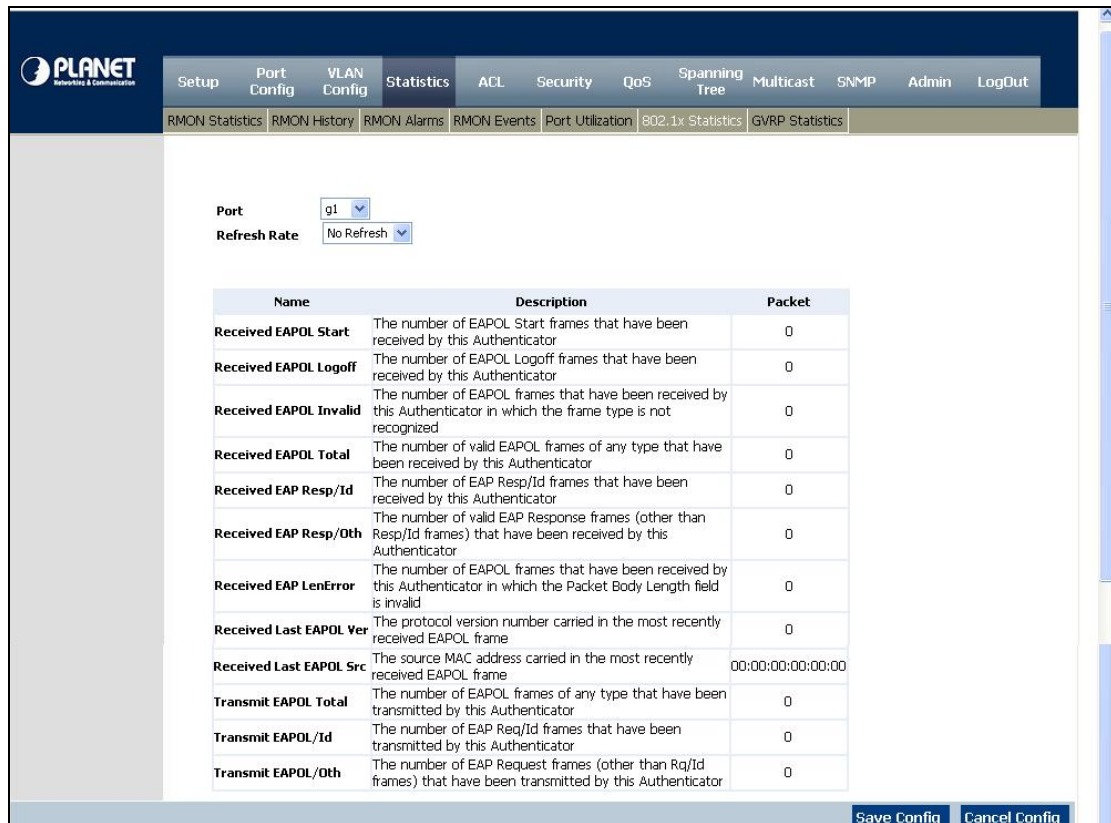

Figure 4-25 802.1x Statistics screen

The page includes the following fields:

| | |
|---------------------|--|
| Port | Indicates the port, which is polled for statistics. |
| Refresh Rate | Indicates the amount of time that passes before the EAP statistics are refreshed. The possible field values are: <ul style="list-style-type: none"> • No Refresh, indicates that the EAP statistics are not refreshed. • 15 Sec, which indicates that the EAP statistics are refreshed every 15 seconds. • 30 Sec, which indicates that the EAP statistics are refreshed every 30 seconds. • 60 Sec, which indicates that the EAP statistics are refreshed every 60 seconds |
| Name | Displays the measured 802.1x statistic. |
| Description | Describes the measured 802.1x statistic. |
| Packet | Displays the amount of packets measured for the particular 802.1x statistic. |

4.5.7 GVRP Statistics

The GVRP Statistics screen (see figure 4-26) contains device statistics for GVRP.

The GVRP Statistics screen is divided into two areas, **GVRP Statistics Table** and **GVRP Error Statistics Table**.

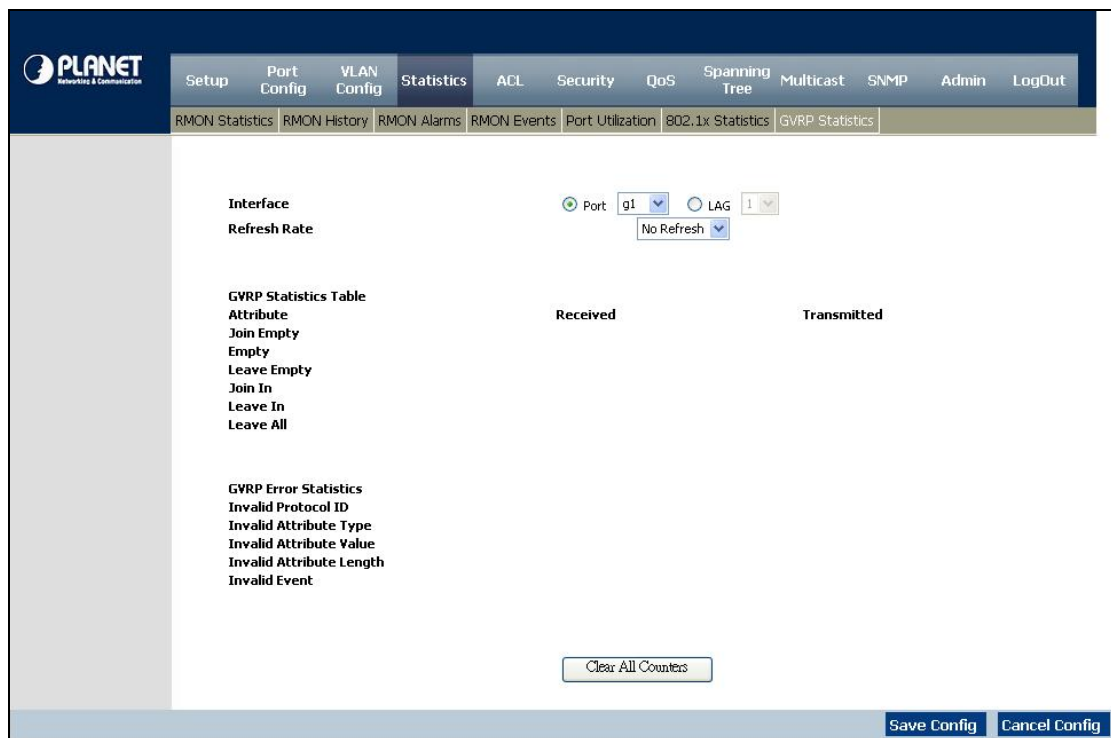

Figure 4-26 GVRP Statistics screen

The following fields are relevant for both tables:

| | |
|---------------------|--|
| Interface | Specifies the interface type for which the statistics are displayed. <ul style="list-style-type: none"> • Port, indicates port statistics are displayed. • LAG, indicates LAG statistics are displayed. |
| Refresh Rate | Indicates the amount of time that passes before the GVRP statistics are refreshed. The possible field values are: <ul style="list-style-type: none"> • No Refresh, indicates that the GVRP statistics are not refreshed. • 15 Sec, which indicates that the GVRP statistics are refreshed every 15 seconds. • 30 Sec, which indicates that the GVRP statistics are refreshed every 30 seconds. • 60 Sec, which indicates that the GVRP statistics are refreshed every 60 seconds. |

The **GVRP Statistics Table** contains the following fields:

| | |
|--------------------|---|
| Join Empty | Which displays the device GVRP Join Empty statistics. |
| Empty | Displays the device GVRP Empty statistics. |
| Leave Empty | By which displays the device GVRP Leave Empty statistics. |
| Join In | By which displays the device GVRP Join In statistics. |
| Leave In | By which displays the device GVRP Leave in statistics. |
| Leave All | By which displays the device GVRP Leave all statistics. |

The **GVRP Error Statistics Table** contains the following fields:

| | |
|-------------------------------|--|
| Invalid Protocol ID | Where displays the device GVRP Invalid Protocol ID statistics. |
| Invalid Attribute Type | Where displays the device GVRP Invalid Attribute ID statistics. Invalid. |
| Attribute Value | Displays the device GVRP Invalid Attribute Value statistics. Invalid Attribute Length, where displays the device GVRP Invalid Attribute Length statistics. |
| Invalid Events | Where displays the device GVRP Invalid Events statistics. The Clear All Counters button resets all tables. |

4.6 ACL

An ACL consists of a set of rules which are matched sequentially against a packet. When a packet meets the match criteria of a rule, the specified rule action (Permit/Deny) is taken and the additional rules are not checked for a match. On this menu the interfaces to which an ACL applies must be specified, as well as whether it applies to inbound or outbound traffic. Rules for the ACL are specified/created using the ACL Rule Configuration menu.

4.6.1 IP Based ACL

The IP Based ACL (Access Control List) screen (see figure 4-27) contains information for defining IP Based ACLs.

The screenshot shows the 'IP based ACL' configuration page. At the top, there are navigation tabs for 'Setup', 'Port Config', 'VLAN Config', 'Statistics', 'ACL', 'Security', 'QoS', 'Spanning Tree', 'Multicast', 'SNMP', 'Admin', and 'LogOut'. Below these, there are sub-tabs for 'IP based ACL' and 'MAC based ACL'. The main configuration area includes:

- ACL Name:** A dropdown menu set to 'Select an ACL' and a 'Delete ACL' checkbox.
- New ACL Name:** A text input field containing 'All-income-drop'.
- Action:** A dropdown menu set to 'Deny'.
- Protocol:** A radio button for 'Select from List' (selected) and a dropdown set to 'Any', plus a 'Protocol ID To Match' input field.
- TCP Flags:** Checkboxes for 'Urg', 'Ack', 'Psh', 'Rst', 'Syn', and 'Fin', each with a 'Set' button.
- Source Port and Destination Port:** Radio buttons for 'Any' (selected) and an input field.
- Source IP Address and Destination IP Address:** Input fields for IP addresses and 'Wild Card Mask'.
- Match DSCP and Match IP Precedence:** Radio buttons for 'Any' (selected) and an input field.
- Update:** A button to save the configuration.

Below the configuration fields is a table showing the current rule:

| Action | Protocol | Source Port | Destination Port | Source IP Address | Destination IP Address | Match DSCP | Match IP Precedence |
|--------|----------|-------------|------------------|-------------------|------------------------|------------|---------------------|
| Deny | Any | | | 0.0.0.0 | 0.0.0.0 | | |

At the bottom of the table, there are 'Delete' and 'Cancel' buttons. At the very bottom of the screen, there are 'Save Config' and 'Cancel Config' buttons.

Figure 4-27 IP-Base ACL screen

The Page contains the following fields:

| | |
|-------------------------|---|
| ACL Name | Displays the user-defined IP based ACLs. |
| New ACL Name | Defines a new user-defined IP based ACL. |
| Delete ACL | By which deletes the selected ACL. |
| Action | <p>Indicates the action assigned to the packet matching the ACL. Packets are forwarded or dropped. In addition, the port can be shutdown, a trap can be sent to the network administrator, or a packet assigned rate limiting restrictions for forwarding. The options are as follows:</p> <ul style="list-style-type: none"> • Permit, by which forwards packets which meet the ACL criteria. • Deny, which drops packets which meet the ACL criteria. • Shutdown, where drops packet that meets the ACL criteria, and disables the port to which the packet was addressed. Ports are reactivated from the Port Management screen. |
| Protocol | By which creates an ACE (Access Control Event) based on a specific protocol |
| Select from List | <p>Where selects from a protocols list on which ACE can be based. The possible field values are:</p> <ul style="list-style-type: none"> • Any, matches the protocol to any protocol. • EIGRP, which indicates that the Enhanced Interior Gateway Routing Protocol (EIGRP) is used to classify network flows. • ICMP, which indicates that the Internet Control Message Protocol (ICMP) is used to classify network flows. • IGMP, which indicates that the Internet Group Management Protocol (IGMP) is used to classify network flows. • TCP, which indicates that the Transmission Control Protocol is used to classify network flows. • OSPF, by which matches the packet to the Open Shortest Path First (OSPF) protocol. • UDP, which indicates that the User Datagram Protocol is used to classify network flows. • Protocol ID to Match, adds user-defined protocols to which packets are matched to the ACE. Each protocol has a specific protocol number which is unique. The possible field range is 0-255. |
| TCP Flags | <p>This filters packets by TCP flag. Filtered packets are either forwarded or dropped. Filtering packets by TCP flags increases packet control, and network security. The values that can be assigned are:</p> <ul style="list-style-type: none"> • Set, which enables filtering packets by selected flags. • Unset, disables filtering packets by selected flags. • Don't care, which indicates that selected packets do not influence the packet |

filtering process.

The TCP Flags that can be selected are:

- **Urg**, indicates the packet is urgent.
- **Ack**, indicates the packet is acknowledged.
- **Psh**, indicates the packet is pushed.
- **Rst**, indicates the connection is dropped.
- **Syn**, indicates request to start a session.
- **Fin**, indicates request to close a session.

| | |
|-------------------------------|---|
| Source Port | Defines the TCP/UDP source port to which the ACE is matched. This field is active only if 800/6-TCP or 800/17-UDP is selected in the Select from List drop-down menu. The possible field range is 0 – 65535 . |
| Destination Port | Defines the TCP/UDP destination port. This field is active only if 800/6-TCP or 800/17-UDP is selected in the Select from List drop-down menu. The possible field range is 0 – 65535 . |
| Source IP Address | Matches the source port IP address to which packets are addressed to the ACE. |
| Wildcard Mask | <p>Defines the source IP address wildcard mask. Wildcard masks specify which bits are used and which bits are ignored.</p> <p>A wild card mask of 255.255.255.255 indicates that no bit is important.</p> <p>A wildcard of 0.0.0.0 indicates that all the bits are important.</p> <p>For example, if the source IP address 149.36.184.198 and the wildcard mask is 255.36.184.00, the first eight bits of the IP address are ignored, while the last eight bits are used.</p> |
| Destination IP Address | Matches the destination port IP address to which packets are addressed to the ACE |
| Wildcard Mask | Defines the destination IP address wildcard mask. |
| Match DSCP | <p>Matches the packet DSCP value to the ACE. Either the DSCP value or the IP Precedence value is used to match packets to ACLs.</p> <p>The possible field range is 0-63.</p> |
| Match IP Precedence | <p>Matches the packet IP Precedence value to the ACE. Either the DSCP value or the IP Precedence value is used to match packets to ACLs.</p> <p>The possible field range is 0-7.</p> |

Use the **Add to List** button when you add the configured IP Based ACLs to the IP Based ACL Table at the bottom of the screen.

4.6.2 IP Based ACL Configure Sample

This section shows how to build a IP Based ACL and apply to specify interface.

■ **Sample Case: Deny IP packets to specific Class C network**

➤ **Purpose:**

Verify a positive and negative matches to network IP address with a **Class C (24 bit mask)** , no matter the rule defined as permit or deny.

1. **Any packets** pass through the switch will be **dropped** – if the Destination IP Addresses match specific **Class C**.
2. **Any packets** pass through the switch will be **forwarded** – if the Destination IP Addresses **not** match specific **Class C**.

➤ **Case Design:**

| | |
|------------------------|---------------------------------------|
| Action | DENY |
| Match | IP |
| Source IP Address | Any |
| Destination IP Address | Class C 172.16.0.0 / 255.255.255.0 |
| Applied Interface | Interface g1 |

➤ **Device Connection and Configuration:**

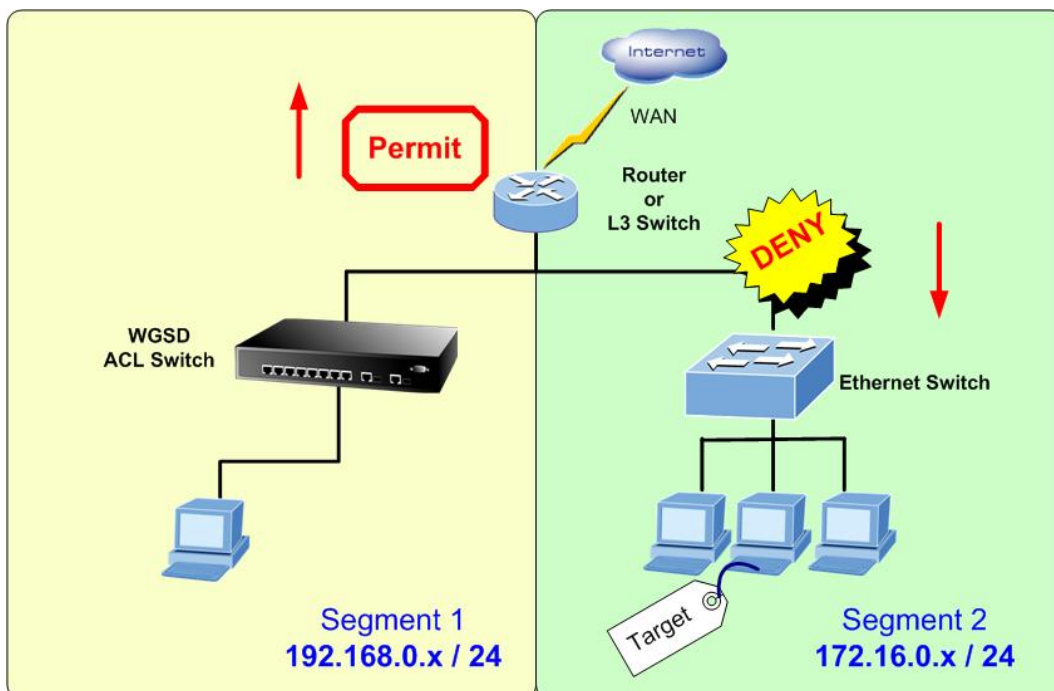

| Target | Stream | | | Protocol |
|--------|--------|----------------|-------------------------------|----------|
| | ID | Source Address | Destination Address | |
| Any | 3 | Any | 172.16.0.0 / 255.255.255.0 | Any |

The procedure as following

■ Create Deny ACL and add to list.

1. **[DENY Rule]:** Choose “New ACL Name”, then key in “Deny-IP Destination A”. Choose “Action”—“Deny”.
(The ACL Name can de entered with other policy name).
2. **[DENY Rule]:** Keep the “Source IP Address” and “Wild Card Mask” be blanked.
3. **[DENY Rule]:** Enter “172.16.0.0” in the “Destination IP Address” and “0.0.0.255” in the Wild Card Mask.
4. After click “Add to List” button, the entry would be show at the table.

| Action | Protocol | Source Port | Destination Port | Source IP Address | Destination IP Address | Match DSCP | Match IP Precedence |
|--------|----------|-------------|------------------|-------------------|------------------------|------------|---------------------|
| Deny | Any | | | | 172.16.0.0 | | |

Delete Cancel

■ **Create Permit ACL and add to list**

5. **[Permit Rule]:** Within the same ACL *“Deny-IP Destination A”*, choose **“Action”**—**“Permit”**.
6. **[Permit Rule]:** Keep the **“Source IP Address”** and **“Wild Card Mask”** be blanked.
7. **[Permit Rule]:** Keep the **“Destination IP Address”** and **“Wild Card Mask”** be blanked.
8. After click **“Add to List”** button, the entry would be show at the table.
9. Rember to click the **“Save Config”** button.

| Action | Protocol | Source Port | Destination Port | Source IP Address | Destination IP Address | Match DSCP | Match IP Precedence |
|--------|----------|-------------|------------------|-------------------|------------------------|------------|---------------------|
| Deny | Any | | | | 172.16.0.0 | | |
| Permit | Any | | | | | | |

Delete Cancel

■ **Binding the IP ACL to specify interface**

10. Select **“Security” \ “ACL Binding”** in the Menu bar.
11. Choose Port **“g1”** at the Interface.
12. Choose **“IP Based ACL”**, select ACL name with *“Deny-Source A”* – that we had been created at step-1. Click **“Add to List”** button, the entry would be show at the table.

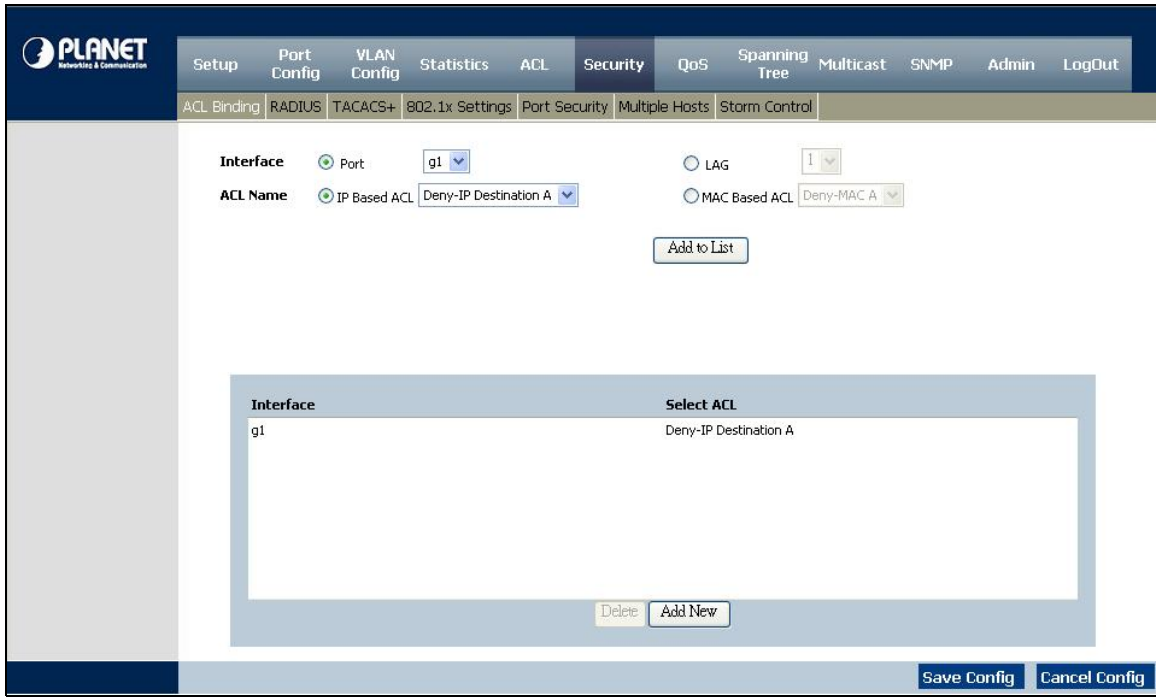

4.6.3 MAC Based ACL

The MAC Based ACL screen (see figure 4-28) allows a MAC based ACL to be defined. ACEs can be added only if the ACL is not bound to an interface.

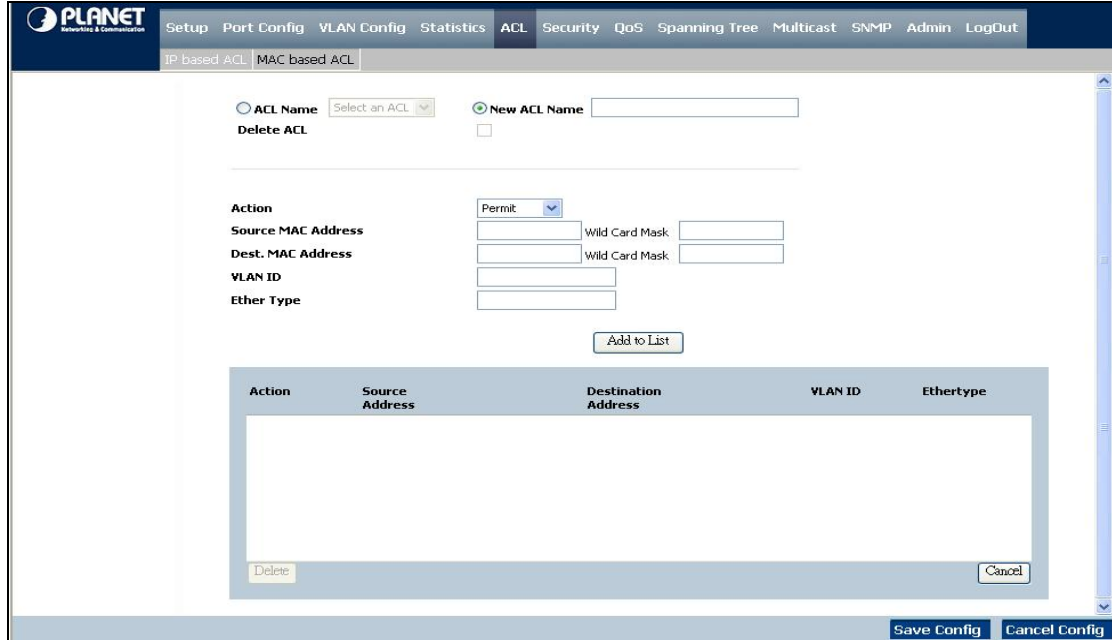

Figure 4-28 MAC-Base ACL screen

The Page contains the following fields:

| | |
|---------------------------|---|
| ACL Name | Displays the user-defined MAC based ACLs |
| New ACL Name | Specifies a new user-defined MAC based ACL name. |
| Delete ACL | By which deletes the selected ACL |
| Action | Indicates the ACL forwarding action. Possible field values are: <ul style="list-style-type: none"> • Permit, by which forwards packets which meet the ACL criteria. • Deny, drops packets which meet the ACL criteria. • Shutdown, where drops packet that meet the ACL criteria, and disables the port to which the packet was addressed. |
| Source MAC Address | Matches the source MAC address to which packets are addressed to the ACE. |
| Wildcard Mask | Defines the source IP address wildcard mask. Wildcard masks specify which bits are used and ignored. <p>A wild card mask of 255.255.255.255 indicates that no bit is important.</p> <p>A wildcard of 0.0.0.0 indicates that all the bits are important.</p> <p>For example, if the source IP address 149.36.184.198 and the wildcard mask is 255.36.184.00, the first eight bits of the IP address are ignored, while the last eight bits are used.</p> |
| Dest. MAC Address | Where matches the destination MAC address to which packets are addressed to the ACE. <p>Wildcard Mask, which defines the destination IP address wildcard mask.</p> |
| VLAN ID | Which matches the packet's VLAN ID to the ACE. <p>The possible field values are 2 to 4094.</p> |
| Ether Type | Where specifies the packet's Ethernet type. |

Use the "**Add to List**" button to add the configured MAC Based ACLs to the MAC Based ACL Table at the bottom of the screen.

4.6.4 MAC Based ACL Configure Sample

This chapter will teach you how to configure a MAC based ACL in the Switch.

■ Sample Case: Deny IP packets to specific Class C network

➤ Purpose:

When the workstation with IP address 192.168.99.188 and MAC address 00-11-08-57-E0-1E ping to PC with IP address 192.168.99.57 and MAC address 00-30-4F-1D-9F-DE, use MAC based ACL function from ACL to deny or shutdown and permit the traffic transmit ability of notebook that connect to port 8 of Switch.

➤ Case Design:

| | |
|-------------------------|-------------------|
| Action | DENY |
| Match | MAC Address |
| Source MAC Address | 00-11-08-57-E0-1E |
| Destination MAC Address | 00-30-4F-1D-9F-DE |
| Applied Interface | Interface g2 |

➤ Device Connection and Configuration:

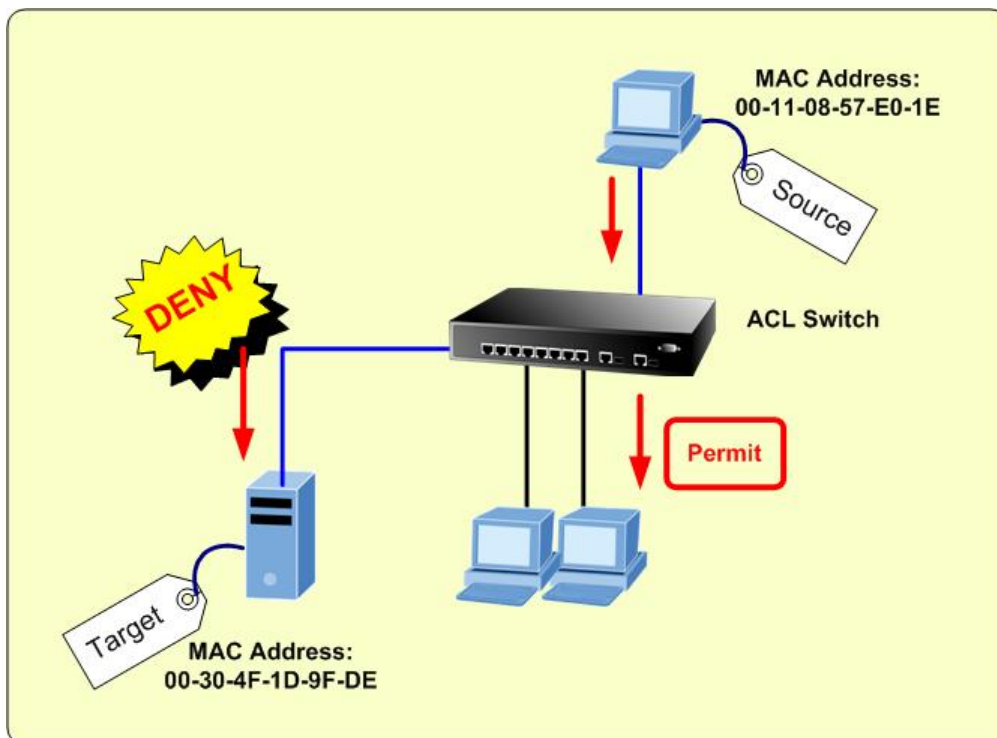

Setting procedure from Switch Web interface:

■ Create Deny MAC ACL and add to list

1. Please enter into Web interface and choose "ACL" function,
2. Then choose "MAC based ACL" function.
3. Please input a new ACL name, for example: "Deny MAC A".

4. To defined "Permit", "Deny" or "Shutdown" from Action item.
5. **[Deny Rule]:** Input Source MAC Address "00:11:08:57:E0:1E" with Wild Card Mask "00:00:00:00:00:00".
6. **[Deny Rule]:** Enter Dest. Mac Address "00:30:4F:1D:9F:DE" with Wild Card Mask "00:00:00:00:00:00".
7. **[Deny Rule]:**Input the VLAN ID and default VLAN ID is 1.
8. Press "Add to List" button to complete this setting.

| Action | Source Address | Destination Address | VLAN ID | Ethertype |
|--------|-------------------|---------------------|---------|-----------|
| Deny | 00:11:08:57:E0:1E | 00:30:4F:1D:9F:DE | 1 | |

Buttons: Delete, Cancel

■ **Create Permit MAC ACL and add to list (To allow all other packets be forwarded)**

9. **[Permit Rule]:** Within the same ACL "*Deny-MAC A*", choose "Action"—"**Permit**".
10. **[Permit Rule]:** Keep the "Source MAC Address" and "Wild Card Mask" be blanked.
11. **[Permit Rule]:** Keep the "Destination MAC Address" and "Wild Card Mask" be blanked.
12. After click "**Add to List**" button, the entry would be show at the table.

ACL Name
 New ACL Name

Delete ACL

Action

Source MAC Address **Wild Card Mask**

Dest. MAC Address **Wild Card Mask**

VLAN ID

Ether Type

| Action | Source Address | Destination Address | VLAN ID | Ethertype |
|--------|-------------------|---------------------|---------|-----------|
| Deny | 00:11:08:57:E0:1E | 00:30:4F:1D:9F:DE | 1 | |
| Permit | | | | |

13. Please press "**Save Config**" to save current setting.

■ **Binding the MAC ACL to specify interface**

14. Select "**Security**" \ "**ACL Binding**" in the Menu bar.
15. Choose Port "**g2**" from Interface item.
16. Choose "**MAC Based ACL**", select ACL name with "**Deny-MAC A**" – that we had been created at step-1. Click "**Add to List**" button, the entry would be show at the table.

The screenshot shows the PLANET network configuration interface. The top navigation bar includes: Setup, Port Config, VLAN Config, Statistics, ACL, Security, QoS, Spanning Tree, Multicast, SNMP, Admin, and LogOut. Below this, a sub-menu shows: ACL Binding, RADIUS, TACACS+, 802.1x Settings, Port Security, Multiple Hosts, and Storm Control. The main configuration area is for the Security section, specifically for interface g2. It shows two radio buttons for 'Interface': 'Port' (selected) and 'LAG'. The 'Port' option has a dropdown menu showing 'g2'. The 'LAG' option has a dropdown menu showing '1'. Under 'ACL Name', there are two radio buttons: 'IP Based ACL' (selected) and 'MAC Based ACL'. The 'IP Based ACL' option has a dropdown menu showing 'Deny-Source A'. The 'MAC Based ACL' option has a dropdown menu showing 'Deny-MAC A'. Below these options is an 'Add to List' button. A table below shows the current configuration:

| Interface | Select ACL |
|-----------|------------|
| g2 | Deny-MAC A |

At the bottom of the table are 'Delete' and 'Add New' buttons. At the bottom right of the interface are 'Save Config' and 'Cancel Config' buttons.

17. Please press "**Save Config**" to save current setting.

Notice: If action "**shutdown**" is selected, the port will be force disabled

4.7 Security

This section is to control the security access of the Switch, includes the user access and management control.

The Security function contains links to the following topics:

- **ACL Binding**
- **RADIUS**
- **TACACS+**
- **802.1x Settings**
- **Port Security**
- **Multiple Hosts**
- **Storm Control**

4.7.1 ACL Binding

When an ACL is bound to an interface, all the **ACE (Access Control Event)** rules that have been defined are applied to the selected interface. Whenever an ACL is assigned on a port, LAG or, VLAN, flows from that ingress interface that do not match the ACL are matched to the default rule, which is Drop unmatched packets. You can refer to figure 4-29.

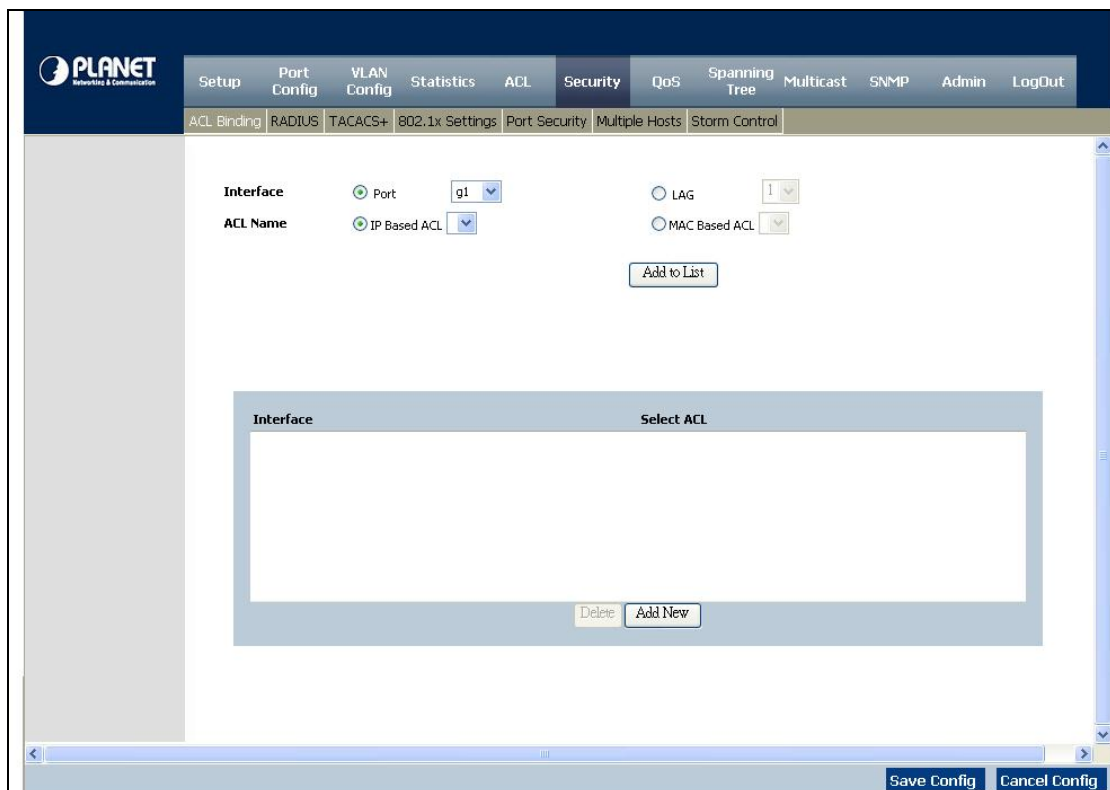

Figure 4-29 ACL Binding screen

The Page contains the following fields:

| | |
|------------------|---|
| Interface | Indicates the interface to which the ACL is bound. The selection includes: <ul style="list-style-type: none"> • Port, indicates port to apply the ACL • LAG, indicates LAG to apply the ACL |
| ACL Name | Indicates the ACL which is bound to the interface. The selection includes: <ul style="list-style-type: none"> • IP Based ACL • MAC Based ACL |

Use the **Add to List** button to add the ACL Binding configuration to the ACL Binding Table at the bottom of the screen.

4.7.2 Radius

Remote Authorization Dial-In User Service (RADIUS) servers provide additional security for networks. RADIUS servers provide a centralized authentication method for web access (see figure 4-30).

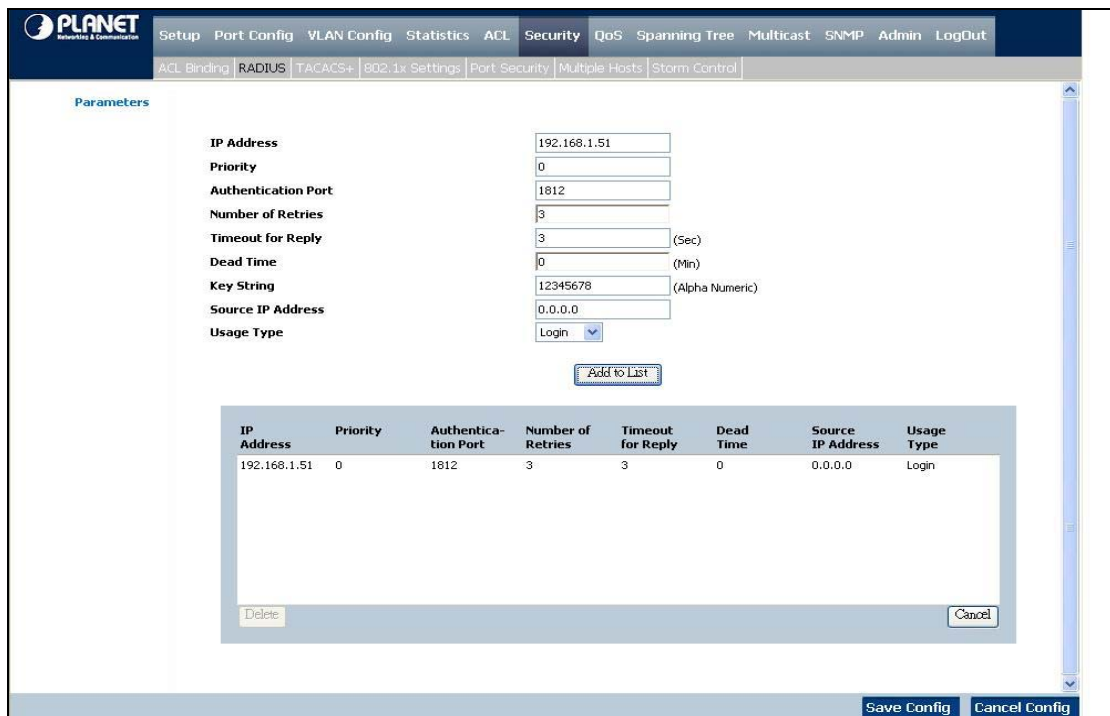

Figure 4-30 RADIUS screen

The Page contains the following fields:

| | |
|----------------------------|--|
| IP Address | The Authentication Server IP address. |
| Priority | Displays the server priority. The possible values are 0-65535, where 1 is the highest value. The RADIUS Server priority is used to configure the server query order. |
| Authentication Port | Identifies the authentication port. The authentication port is used to verify the RADIUS server authentication. The authenticated port default is 1812 . |
| Number of Retries | Defines the number of transmitted requests sent to RADIUS server before a failure occurs. The possible field values are 1 - 10. 3 is the default value. |
| Timeout for Reply | This defines the amount of the time in seconds the device waits for an answer from the RADIUS server before retrying the query, or switching to the next server. The possible field values are 1 - 30. 3 is the default value. |
| Dead Time | This defines the amount of time (minutes) that a RADIUS server is bypassed for service requests. The range is 0-2000. The Dead Time default is 0 minutes. |
| Key String | This defines the default key string used for authenticating and encrypting all RADIUS communications between the device and the RADIUS server. This key must match the RADIUS encryption. |
| Source IP Address | Defines the source IP address that is used for communication with RADIUS servers. |
| Usage Type | Specifies the RADIUS server authentication type. The default value is Login. The possible field values are: <ul style="list-style-type: none"> • Login, indicates that the RADIUS server is used for authenticating user name and passwords. • 802.1X, indicates that the RADIUS server is used for 802.1X authentication. • All, where indicates that the RADIUS server is used for authenticating user name and passwords, and 802.1X port authentication. |

Use the **Add to List** button when you add the RADIUS configuration to the RADIUS Table at the bottom of the screen.

4.7.3 TACACS+

The device provides Terminal Access Controller Access Control System (TACACS+) client support. TACACS+ provides centralized security for validation of users accessing the device. TACACS+ provides a centralized user management system, while still retaining consistency with RADIUS and other authentication processes. The TACACS+ protocol ensures network integrity through encrypted protocol exchanges between the device and TACACS+ server. You can refer to figure 4-31.

Figure 4-31 TACACS+ screen

The Page contains the following fields:

| | |
|------------------------------|---|
| Host IP Address | Indicates the TACACS+ Server IP address. |
| Priority | Displays the order in which the TACACS+ servers are used. The default is 0. |
| Source IP Address | By which displays the device source IP address used for the TACACS+ session between the device and the TACACS+ server. |
| Key String | This defines the authentication and encryption key for TACACS+ server. The key must match the encryption key used on the TACACS+ server. |
| Authentication Port | Displays the port number through which the TACACS+ session occurs. |
| The Timeout for Reply | This displays the amount of time that passes before the connection between the device and the TACACS+ server times out. The field range is 1-30 seconds. |
| Status | Displays the connection status between the device and the TACACS+ server. The possible field values are: <ul style="list-style-type: none"> • Connected, there is currently a connection between the device and the TACACS+ server. • Not Connected, there is not currently a connection between the device and the TACACS+ server. |
| Single Connection | Maintains a single open connection between the device and the TACACS+ server when selected the Add to List button to add the TACACS+ configuration to the TACACS+ table at the bottom of the screen. |

4.7.4 802.1x settings

Understanding IEEE 802.1X Port-Based Authentication

The IEEE 802.1X standard defines a client-server-based access control and authentication protocol that restricts unauthorized clients from connecting to a LAN through publicly accessible ports. The authentication server authenticates each client connected to a switch port before making available any services offered by the switch or the LAN.

Until the client is authenticated, 802.1X access control allows only Extensible Authentication Protocol over LAN (EAPOL) traffic through the port to which the client is connected. After authentication is successful, normal traffic can pass through the port.

This section includes this conceptual information:

- [Device Roles](#)
- [Authentication Initiation and Message Exchange](#)
- [Ports in Authorized and Unauthorized States](#)

■ Device Roles

With 802.1X port-based authentication, the devices in the network have specific roles as shown below.

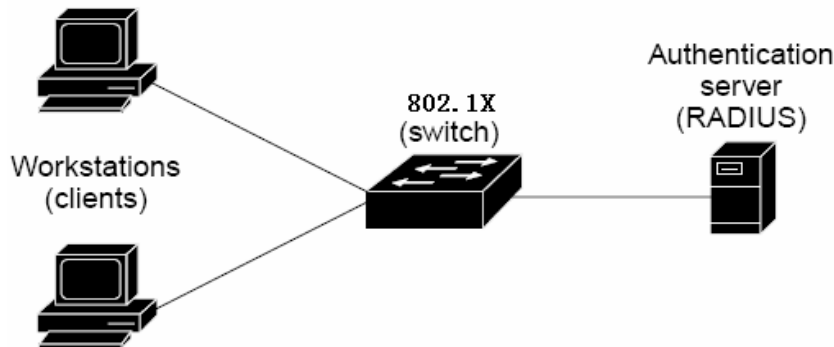

- **Client**—the device (workstation) that requests access to the LAN and switch services and responds to requests from the switch. The workstation must be running 802.1X-compliant client software such as that offered in the Microsoft Windows XP operating system. (The client is the *supplicant* in the IEEE 802.1X specification.)
- **Authentication server**—performs the actual authentication of the client. The authentication server validates the identity of the client and notifies the switch whether or not the client is authorized to access the LAN and switch services. Because the switch acts as the proxy, the authentication service is transparent to the client. In this release, the Remote Authentication Dial-In User Service (RADIUS) security system with Extensible Authentication Protocol (EAP) extensions is the only supported authentication server; it is available in Cisco Secure Access Control Server version 3.0. RADIUS operates in a client/server model in which secure authentication information is exchanged between the RADIUS server and one or more RADIUS clients.
- **Switch (802.1X device)**—controls the physical access to the network based on the authentication status of the client. The switch acts as an intermediary (proxy) between the client and the authentication server, requesting identity information

from the client, verifying that information with the authentication server, and relaying a response to the client. The switch includes the RADIUS client, which is responsible for encapsulating and decapsulating the Extensible Authentication Protocol (EAP) frames and interacting with the authentication server. When the switch receives EAPOL frames and relays them to the authentication server, the Ethernet header is stripped and the remaining EAP frame is re-encapsulated in the RADIUS format. The EAP frames are not modified or examined during encapsulation, and the authentication server must support EAP within the native frame format. When the switch receives frames from the authentication server, the server's frame header is removed, leaving the EAP frame, which is then encapsulated for Ethernet and sent to the client.

■ Authentication Initiation and Message Exchange

The switch or the client can initiate authentication. If you enable authentication on a port by using the **dot1x port-control auto** interface configuration command, the switch must initiate authentication when it determines that the port link state transitions from down to up. It then sends an EAP-request/identity frame to the client to request its identity (typically, the switch sends an initial identity/request frame followed by one or more requests for authentication information). Upon receipt of the frame, the client responds with an EAP-response/identity frame.

However, if during bootup, the client does not receive an EAP-request/identity frame from the switch, the client can initiate authentication by sending an EAPOL-start frame, which prompts the switch to request the client's identity.



If 802.1X is not enabled or supported on the network access device, any EAPOL frames from the client are dropped. If the client does not receive an EAP-request/identity frame after three attempts to start authentication, the client transmits frames as if the port is in the authorized state. A port in the authorized state effectively means that the client has been successfully authenticated.

When the client supplies its identity, the switch begins its role as the intermediary, passing EAP frames between the client and the authentication server until authentication succeeds or fails. If the authentication succeeds, the switch port becomes authorized.

The specific exchange of EAP frames depends on the authentication method being used. Following figure shows a message exchange initiated by the client using the One-Time-Password (OTP) authentication method with a RADIUS server.

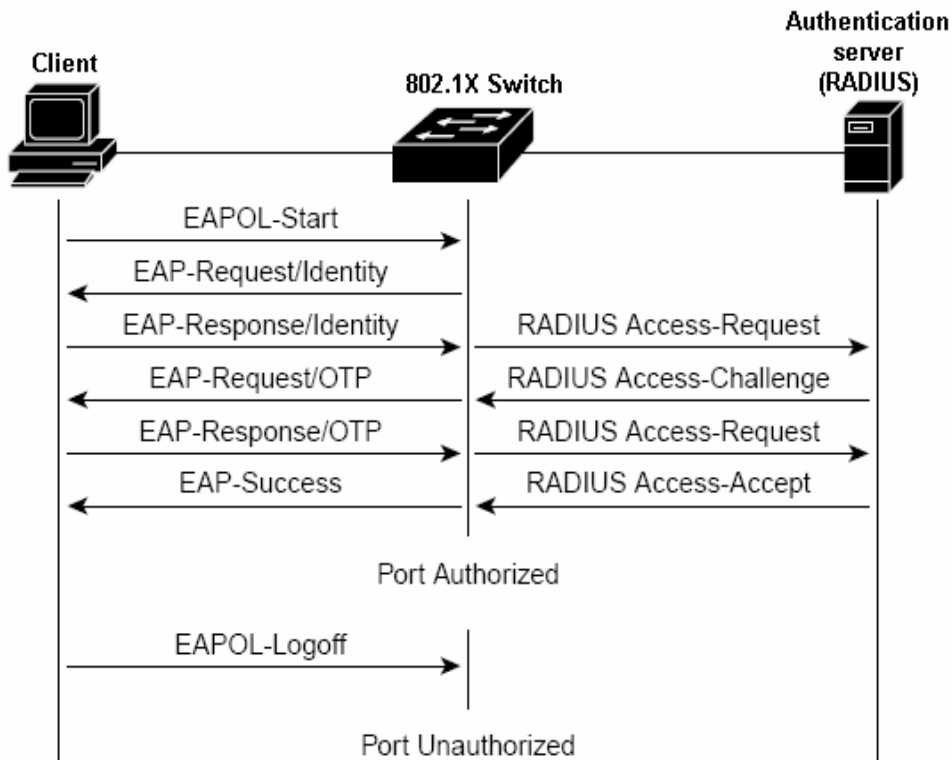

■ Ports in Authorized and Unauthorized States

The switch port state determines whether or not the client is granted access to the network. The port starts in the *unauthorized* state. While in this state, the port disallows all ingress and egress traffic except for 802.1X protocol packets. When a client is successfully authenticated, the port transitions to the *authorized* state, allowing all traffic for the client to flow normally.

If a client that does not support 802.1X is connected to an unauthorized 802.1X port, the switch requests the client's identity. In this situation, the client does not respond to the request, the port remains in the unauthorized state, and the client is not granted access to the network.

In contrast, when an 802.1X-enabled client connects to a port that is not running the 802.1X protocol, the client initiates the authentication process by sending the EAPOL-start frame. When no response is received, the client sends the request for a fixed number of times. Because no response is received, the client begins sending frames as if the port is in the authorized state.

If the client is successfully authenticated (receives an Accept frame from the authentication server), the port state changes to authorized, and all frames from the authenticated client are allowed through the port. If the authentication fails, the port remains in the unauthorized state, but authentication can be retried. If the authentication server cannot be reached, the switch can retransmit the request. If no response is received from the server after the specified number of attempts, authentication fails, and network access is not granted.

When a client logs off, it sends an EAPOL-logoff message, causing the switch port to transition to the unauthorized state.

If the link state of a port transitions from up to down, or if an EAPOL-logoff frame is received, the port returns to the unauthorized state.

■ 802.1X Settings of WGSW-Switch

Port based authentication enables authenticating system users on a per-port basis via an external server. Only authenticated and approved system users can transmit and receive data. Ports are authenticated via the **RADIUS server** using the **Extensible Authentication Protocol (EAP)**. Refer to figure 4-32.

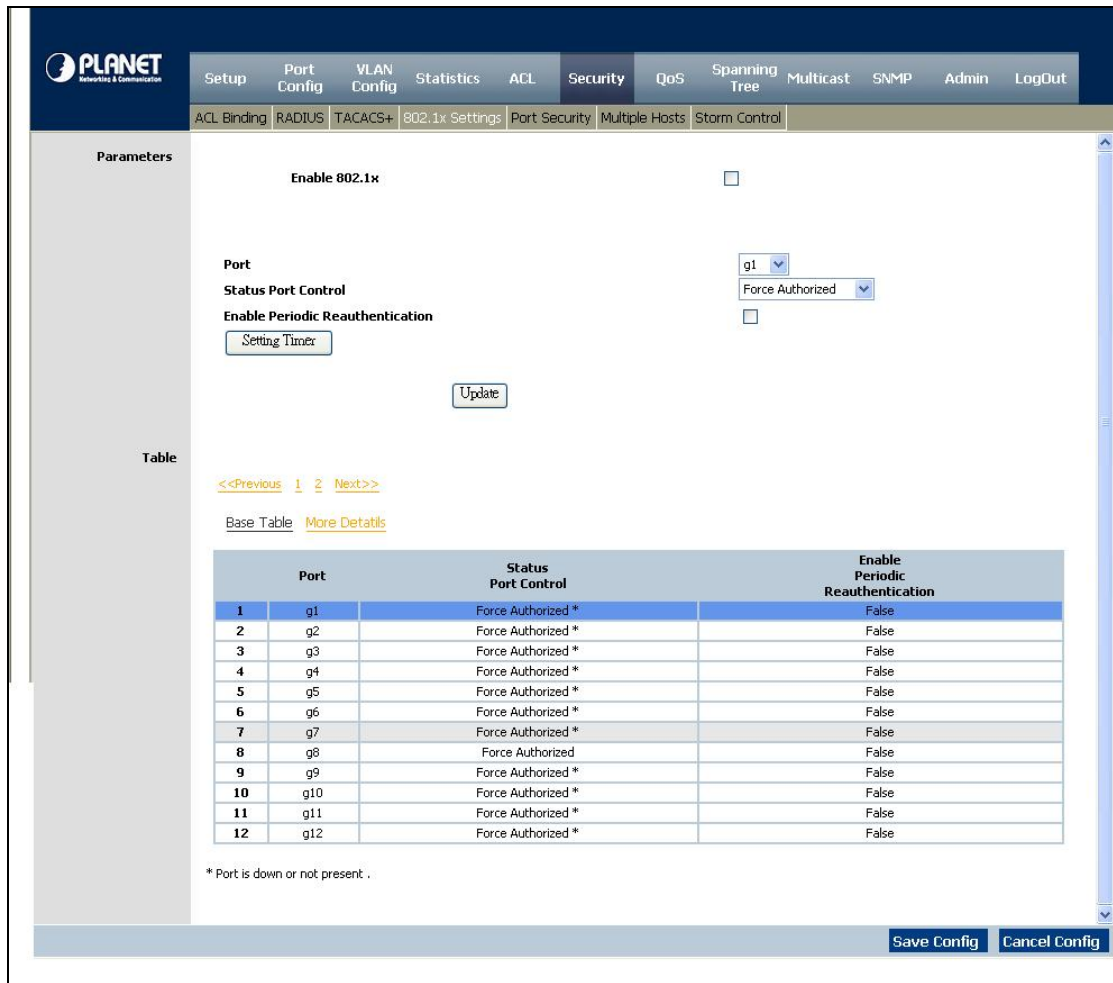

Figure 4-32 802.1x setting screen

The Page contains the following fields:

| | |
|--|---|
| Enable 802.1x | Place a checkmark in the check box to enable 802.1x, authentication. |
| Port | Indicates the port name. |
| Status Port Control | This specifies the port authorization state. The possible field values are as follows: <ul style="list-style-type: none"> • Force-Authorized, the controlled port state is set to Force-Authorized (forward traffic). • Force-Unauthorized, the controlled port state is set to Force-Unauthorized (discard traffic). |
| Enable Periodic Re-authentication | Permits immediate port re-authentication. The Setting Timer button opens the Setting Timer screen to configure ports for 802.1x functionality. |

■ Setting Timer

On this screen, it includes port, re-authentication, resending EAP (Refer to figure 4-33)

| Setting Timer | |
|-------------------------|-----------------------------------|
| Port | g1 |
| Reauthentication Period | <input type="text" value="3600"/> |
| Quiet Period | <input type="text" value="60"/> |
| Resending EAP | <input type="text" value="30"/> |
| Max EAP Requests | <input type="text" value="2"/> |
| Supplicant Timeout | <input type="text" value="30"/> |
| Server Timeout | <input type="text" value="30"/> |

Figure 4-33 Setting Timer parameter screen

The Page contains the following fields:

| | |
|---------------------------|---|
| Quiet Period | Specifies the number of seconds that the switch remains in the quiet state following a failed authentication exchange. (Range: 0-65535). |
| Resending EAP | Specifies the number of seconds that the switch waits for a response to an EAP - request/ identity frame, from the supplicant (client), before resending the requests. |
| Max EAP Requests | Which the total amount of EAP requests sent. If a response is not received after the defined period, the authentication process is restarted. The field default is 2 retries. |
| Supplicant Timeout | Which displays the number of seconds that lapses before EAP requests are resent to the supplicant (Range: 1-65535). The field default is 30 seconds. |
| Server Timeout | Which specifies the number of seconds that lapses before the switch resends a request to the authentication server (Range: 1-65535). The field default is 30 seconds. |

4.7.5 Port Security

Work security screen (see figure 4-34) can be increased by limiting access on a specific port only to users with specific MAC addresses. MAC addresses can be **dynamically learned** or **statically configured**. Locked port security monitors both received and learned packets that are received on specific ports. Access to the locked port is limited to users with specific MAC addresses. These addresses are either manually defined on the port, or learned on that port up to the point when it is locked.

When a packet is received on a locked port, and the packet source MAC address is not tied to that port (either it was learned on a different port, or it is unknown to the system), the protection mechanism is invoked, and can provide various options.

Unauthorized packets arriving at a locked port are either: Forwarded, Discarded with no trap, Discarded with a trap, Cause the port to be shut down.

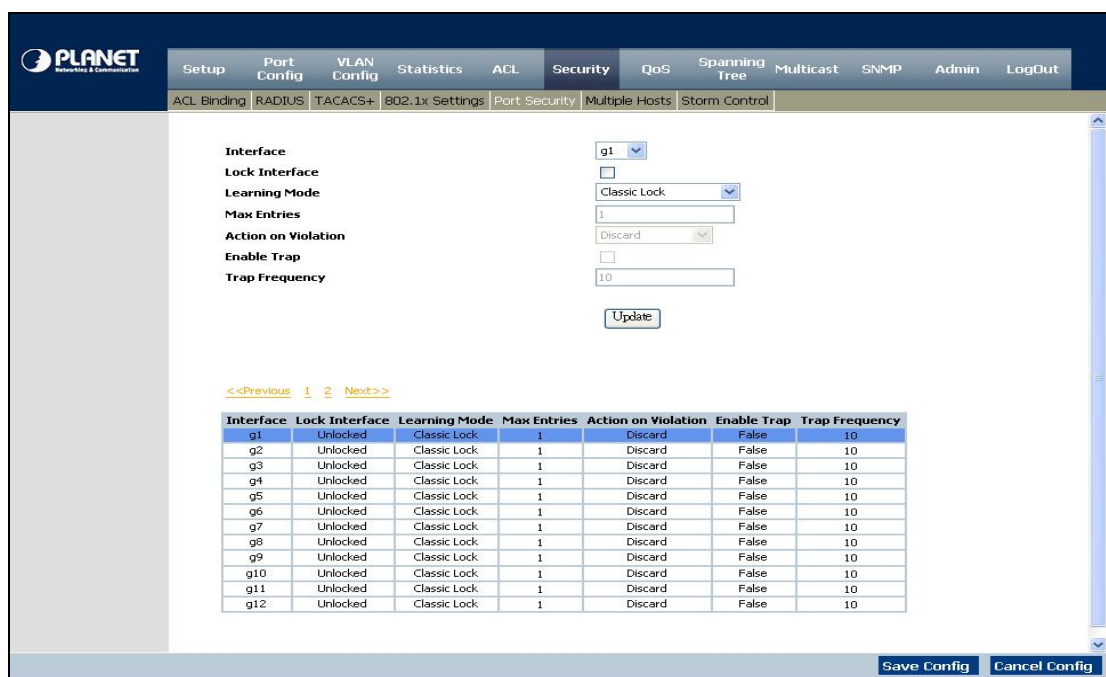

Figure 4-34 Port Security screen

Locked port security also enables storing a list of MAC addresses in the configuration file. The MAC address list can be restored after the device has been reset.

Disabled ports are activated from the Port Security page.

Interface

Where displays the port or LAG name

Lock Interface

Which selecting this option locks the specified interface.

Learning Mode

Where defines the locked port type. The Learning Mode field is enabled only if Locked is selected in the Interface Status field. The possible field values are:

- **Classic Lock**, by which locks the port using the classic lock mechanism. The port is immediately locked, regardless of the number of addresses that have already been learned.
- **Limited Dynamic Lock**, which locks the port by deleting the current dynamic

MAC addresses associated with the port. The port learns up to the maximum addresses allowed on the port. Both relearning and aging MAC addresses are enabled.

Max Entries Specifies the number of MAC addresses that can be learned on the port. The Max Entries field is enabled only if Locked is selected in the Interface Status field. In addition, the Limited Dynamic Lock mode is selected.

The default is **1**.

Action on Violation Where indicates the action to be applied to packets arriving on a locked port. The possible field values are:

- **Discard**, which discards packets from any unlearned source. This is the default value.
- **Forward Normal**, forwards packets from an unknown source without learning the MAC address.
- **Discard Disable**, which discards packets from any unlearned source and shuts down the port. The port remains shut down until reactivated, or until the device is reset.

Enable Trap This enables traps when a packet is received on a locked port.

Trap Frequency Which the amount of time (in seconds) between traps.

The default value is **10** seconds

 **Notice** In order to change the Learning Mode, the Lock Interface must be set to unlocked. Once the mode is changed, the Lock Interface can be reinstated.

4.7.6 Multiple Hosts

The Multiple Hosts screen (see figure 4-35) allows network managers to configure advanced port-based authentication settings for specific ports and VLANs.

The screenshot shows the 'Multiple Hosts' configuration page. At the top, there is a navigation menu with tabs for Setup, Port Config, VLAN Config, Statistics, ACL, Security, QoS, Spanning Tree, Multicast, SNMP, Admin, and LogOut. Below this, there is a sub-menu with tabs for ACL Binding, RADIUS, TACACS+, 802.1x Settings, Port Security, Multiple Hosts, and Storm Control. The 'Multiple Hosts' tab is selected.

The configuration area includes the following fields:

- Port:** A dropdown menu showing 'g1'.
- Enable Multiple Hosts:** A checkbox that is currently unchecked.
- Action on Violation:** A dropdown menu showing 'Discard'.
- Enable Traps:** A checkbox that is currently unchecked.
- Trap Frequency:** A text input field containing the value '10'.

Below the configuration fields is an 'Update' button. At the bottom of the configuration area, there are navigation links: '<<Previous', '1', and 'Next>>'.

The main part of the screen displays a table with the following columns: Port, Multiple Hosts, Action on Violation, Traps, Trap Frequency, Status, and Number of Violations. The table contains 12 rows, one for each port from g1 to g12. All ports are currently in 'Not in auto mode*' status and have 0 violations.

| Port | Multiple Hosts | Action on Violation | Traps | Trap Frequency | Status | Number of Violations |
|------|----------------|---------------------|-------|----------------|-------------------|----------------------|
| g1 | Single | Discard | False | 10 | Not in auto mode* | 0 |
| g2 | Single | Discard | False | 10 | Not in auto mode* | 0 |
| g3 | Single | Discard | False | 10 | Not in auto mode* | 0 |
| g4 | Single | Discard | False | 10 | Not in auto mode* | 0 |
| g5 | Single | Discard | False | 10 | Not in auto mode* | 0 |
| g6 | Single | Discard | False | 10 | Not in auto mode* | 0 |
| g7 | Single | Discard | False | 10 | Not in auto mode* | 0 |
| g8 | Single | Discard | False | 10 | Not in auto mode* | 0 |
| g9 | Single | Discard | False | 10 | Not in auto mode* | 0 |
| g10 | Single | Discard | False | 10 | Not in auto mode* | 0 |
| g11 | Single | Discard | False | 10 | Not in auto mode* | 0 |
| g12 | Single | Discard | False | 10 | Not in auto mode* | 0 |

At the bottom of the screen, there is a note: '* Port is down or not present.' and two buttons: 'Save Config' and 'Cancel Config'.

Figure 4-35 Multiple Hosts screen

The Page contains the following fields:

| | |
|------------------------------|---|
| Port | Displays the port number for which advanced port-based authentication is enabled. |
| Enable Multiple Hosts | When checked, indicates that multiple hosts are enabled. Multiple hosts must be enabled in order to either disable the ingress-filter, or to use port-lock security on the selected port. |
| Action on Violation | This defines the action to be applied to packets arriving in single-host mode, from a host whose MAC address is not the supplicant MAC address. The possible field values are: <ul style="list-style-type: none"> • Discard, which discards the packets. This is the default value. • Forward, by which forwards the packet. • DiscardDisable, discards the packets and shuts down the port. The ports remains shut down until reactivated, or until the device is reset. |
| Enable Traps | When checked, indicates that traps are enabled for Multiple Hosts. |

Trap Frequency Defines the time period by which traps are sent to the host. The Trap Frequency (1-1000000) field can be defined only if multiple hosts are disabled.

The default is **10** seconds.

Status Where indicates the host status.

4.7.7 Storm control

A BroadcastStorm is a result of an excessive amount of broadcast messages simultaneously transmitted across a network by a single port. Forwarded message responses are heaped onto the network, straining network resources or causing the network to time out.

The system measures the incoming Broadcast and Multicast frame rate separately on each port, and discard frames when the rate exceeds a user-defined rate.

The Storm Control page provides fields for enabling and configuring Storm Control. The screen in Figure 4-36 appears.

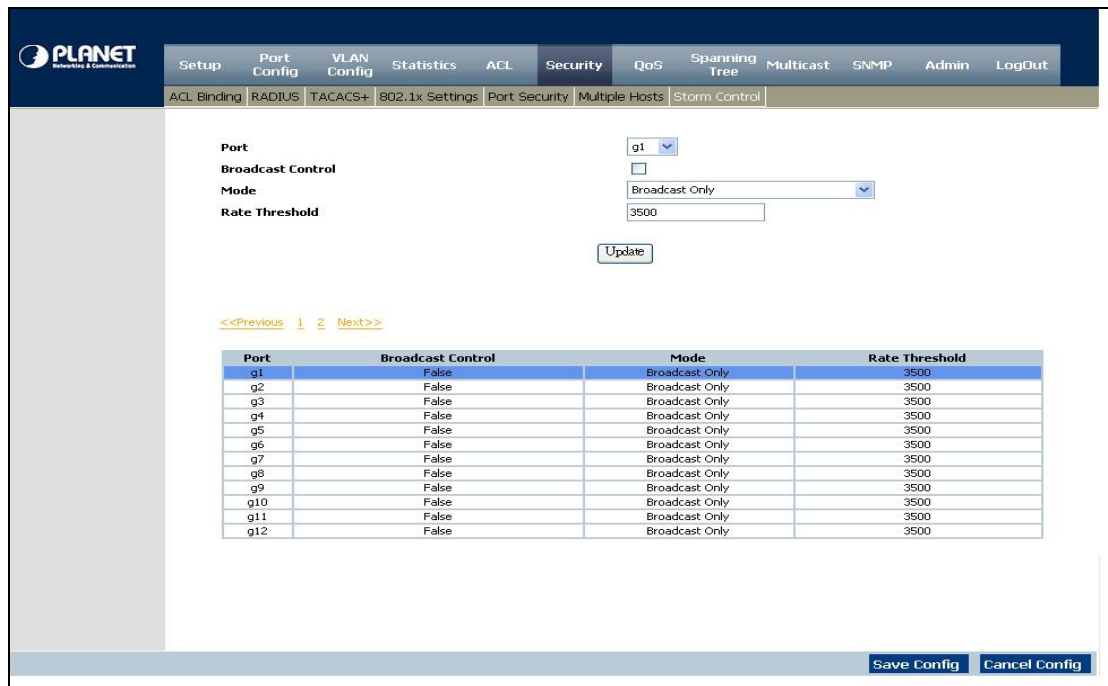

Figure 4-36 Storm Control screen

The Page contains the following fields:

- Port** Displays the port number for which storm control is enabled
- Broadcast Control** This indicates whether broadcast packet types are forwarded on the specific interface.
- Mode** By which specifies the Broadcast mode currently enabled on the device. The possible field values are:
 - **Unknown Unicast, Multicast & Broadcast**, counts Unicast, Multicast, and Broadcast traffic.

- **Multicast & Broadcast**, counts Broadcast and Multicast traffic together.
- **Broadcast Only**, counts only Broadcast traffic.

Rate Threshold Where the maximum rate (packets per second) at which unknown packets are forwarded. The range is 70 -100000.
The default value is **3500**.

4.8 QoS

Network traffic is usually unpredictable, and the only basic assurance that can be offered is best effort traffic delivery. To overcome this challenge, Quality of Service (QoS) is applied throughout the network. This ensures that network traffic is prioritized according to specified criteria, and that specific traffic receives preferential treatment. And Cos Settings, Queue settings, Dscp Settings, Bandwidth, Basic Mode, Advanced mode are provided.

4.8.1 CoS Settings

The terms **Class of Service (CoS)** and QoS are used in the following:

CoS provides varying Layer 2 traffic services. CoS refers to classification of traffic to traffic-classes, which are handled as an aggregate whole, with no per-flow settings. CoS is usually related to the **802.1p** service that classifies flows according to their Layer 2 priority, as set in the VLAN header. QoS refers to Layer 2 traffic and above. QoS handles per-flow settings, even within a single traffic class.

The CoS Settings screen (see figure 4-37) contains fields for enabling or disabling CoS. In addition, the Trust mode can be selected. The Trust mode relies on predefined fields within the packet to determine the egress queue settings. (To configure the Trust Mode, see 4.8.5.)

The CoS Settings screen has two areas, **CoS Settings** and **CoS to Queue**.

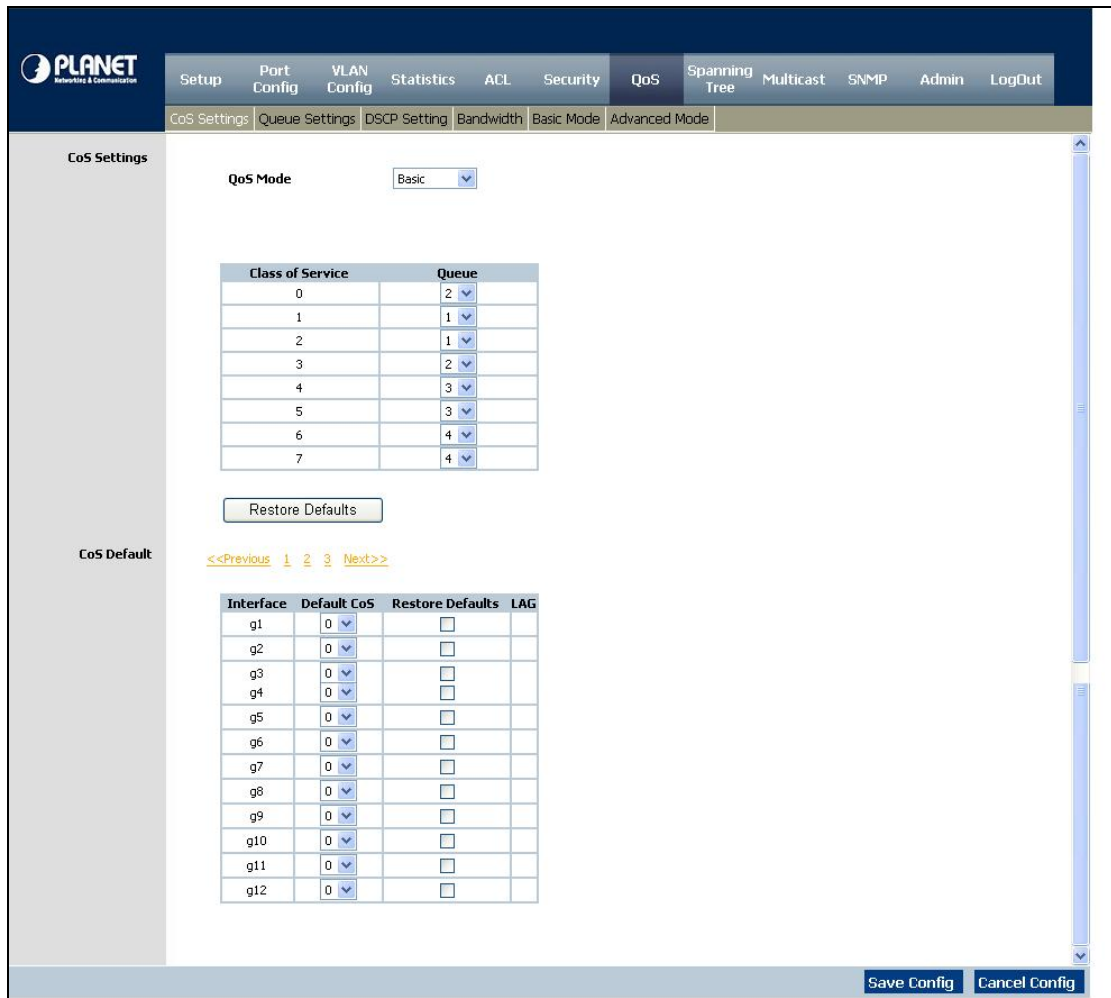

Figure 4-37 CoS Settings screen

The Page contains the following fields:

| | |
|-------------------------|---|
| CoS Mode | This indicates if QoS is enabled on the interface. The possible values are: <ul style="list-style-type: none"> • Disable, disables QoS on the interface. • Basic, enables QoS on the interface. • Advanced, enables the Advanced Mode QoS on the interface. |
| Class of Service | Specifies the CoS priority tag values, where zero is the lowest and 7 is the highest |
| Queue | Defines the traffic forwarding queue to which the CoS priority is mapped. Four traffic priority queues are supported. |

The **Restore Defaults** button restores the device factory defaults for mapping CoS values to a forwarding queue.

■ **CoS Default:**

The Table contains the following fields:

| | |
|-------------------------|--|
| Interface | Interface to which the CoS configuration applies. |
| Default CoS | Determines the default CoS value for incoming packets for which a VLAN tag is not defined. The possible field values are 0-7 . The default CoS is 0 . |
| Restore Defaults | Restores the device factory defaults for mapping CoS values to forwarding queue. |
| LAG | LAG to which the CoS configuration applies. |

4.8.2 Queue Setting

The Queue Setting screen (see figure 4-38) contains fields for defining the QoS queue forwarding types.

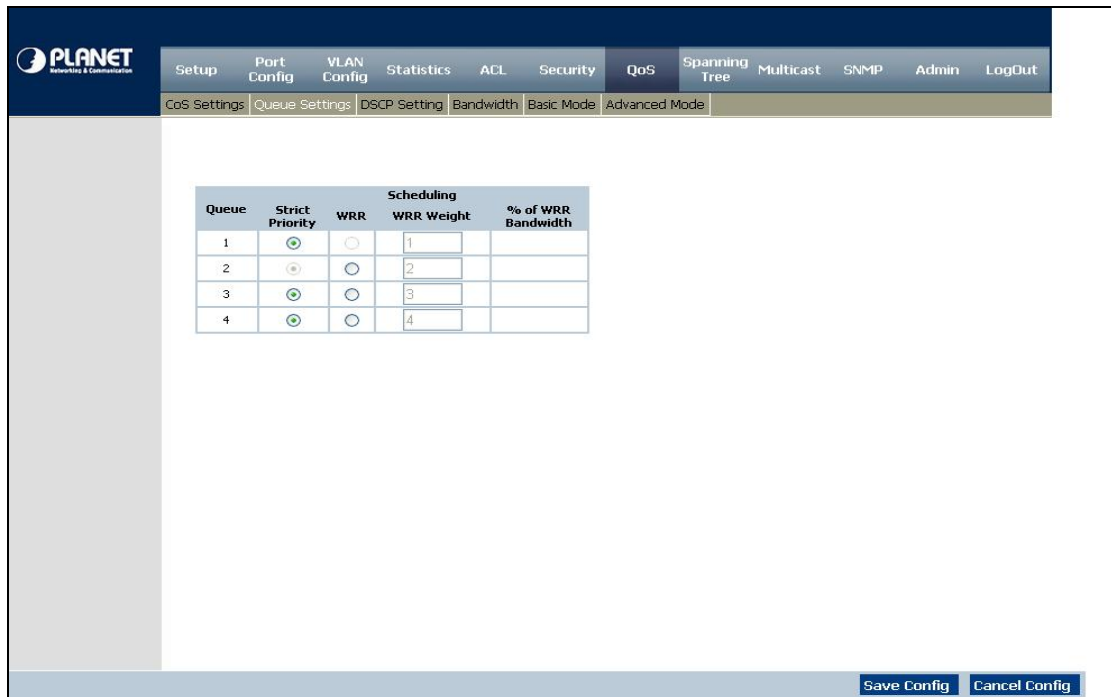

Figure 4-38 Queue Setting screen

The page contains the following fields:

| | |
|------------------------|---|
| Strict Priority | This indicates that traffic scheduling for the selected queue is based strictly on the queue priority. |
| WRR | This indicates that traffic scheduling for the selected queue is based strictly on the WRR. |
| Queue | Shows the queue for which the queue settings are displayed. The possible field range is 1 - 4 . |
| WRR Weight | This displays the WRR weights to queues. Default Rate 1:2:4:8 |

% of WRR Bandwidth Displays the amount of bandwidth assigned to the queue.

These values are fixed and are not user- defined.

- 6.67%
- 13.33%
- 26.67%
- 53.33%

4.8.3 DSCP Settings

The DSCP Settings screen (see figure 4-39) enables mapping DSCP values to specific queues.

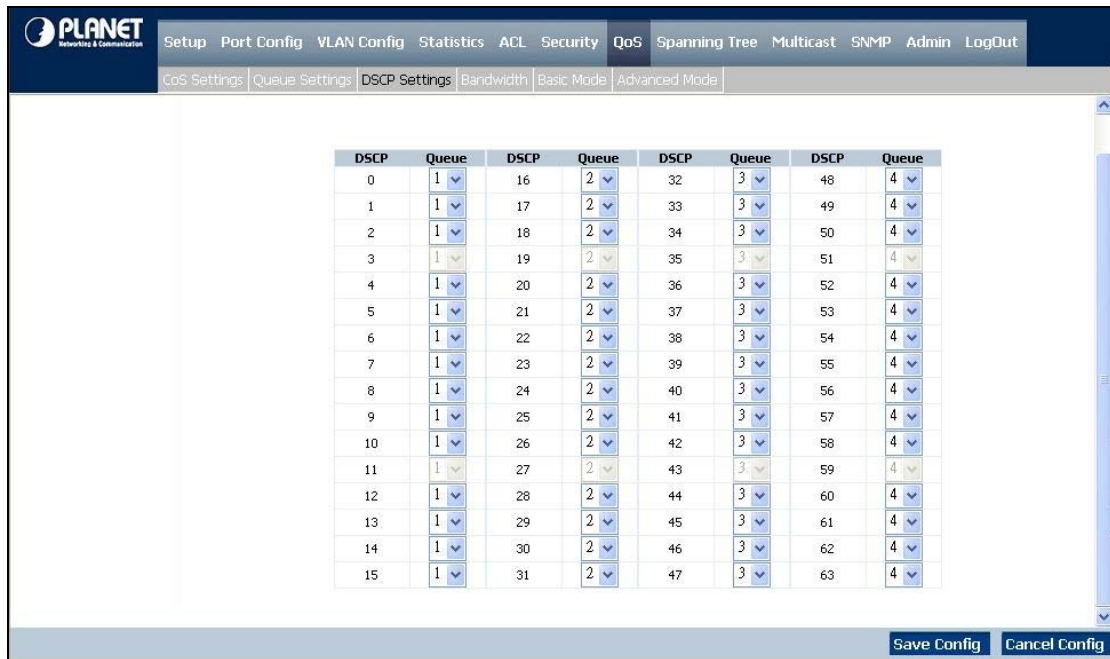

Figure 4-39 DSCP Settings screen

The DSCP Settings screen contains the following fields:

| | |
|--------------|--|
| DSCP | Indicates the Differentiated Services Code Point value in the incoming packet. |
| Queue | Maps the DSCP value to the selected queue. |

4.8.4 Bandwidth

The Bandwidth screen (refer to figure 4-40) allows network managers to define the bandwidth settings for a specified egress interface. Modifying queue scheduling affects the queue settings globally. The Bandwidth screen is not used with the Service mode, as bandwidth settings are based on services.

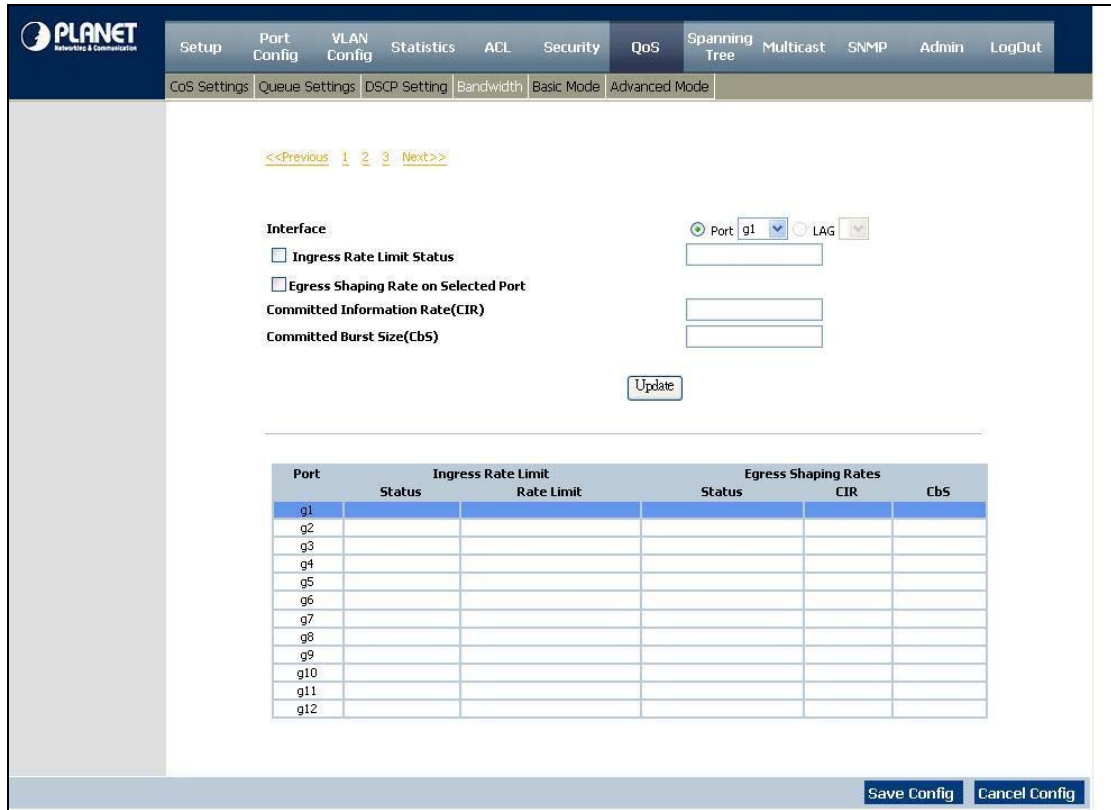

Figure 4-40 Bandwidth screen

Queue shaping can be based per queue and/or per interface. Shaping is determined by the lower specified value. The queue shaping type is selected in the Bandwidth screen, include interface, port, LAG, Rate Limit, Ingress Rate Limit Status, Rate Limit....

The page contains the following fields:

| | |
|---|---|
| Interface | Indicates the interface for which the queue shaping information is displayed. The possible field values are: <ul style="list-style-type: none"> • Port, indicates the port for which the bandwidth settings are displayed. • LAG, indicates the LAG for which the bandwidth settings are displayed. |
| Ingress Rate Limit Status | which indicates if rate limiting is defined on the interface. |
| Rate Limit (62-1000000 Kbps) | Defines the amount of bandwidth assigned to the interface. The possible field values are 62-1000000 Kbps. |
| Egress Shaping Rate on Selected Port | Indicates if rate limiting is enabled on the interface. |

| | |
|------------------------------|---|
| Committed Information | Defines CIR as the queue shaping type. |
| Rate (CIR) | The possible field value is 64 - 1,000,000 Kbps. |

4.8.5 Basic Mode

The Basic Mode screen (see figure 4-41) contains the following fields:

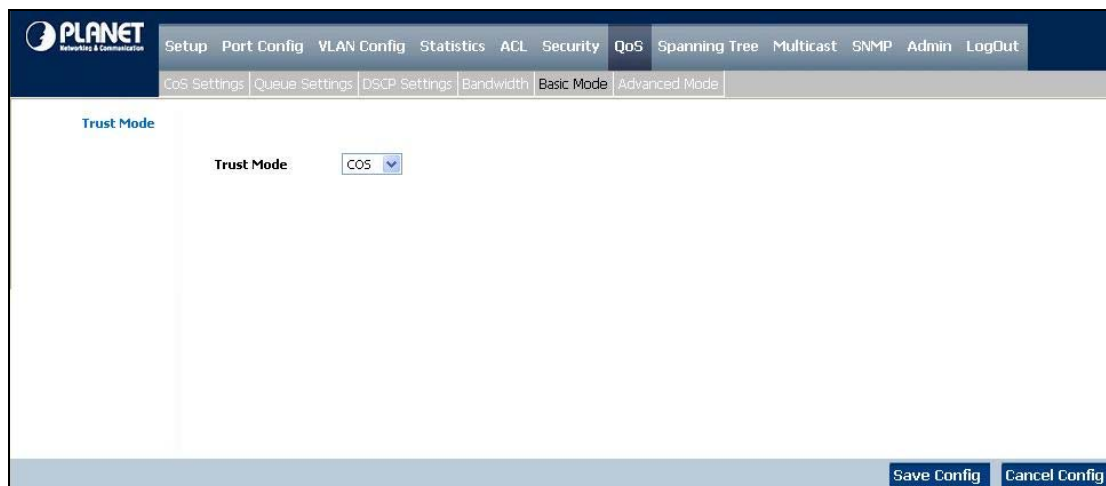

Figure 4-41 Basic Mode screen

The page contains the following fields:

| | |
|-------------------|---|
| Trust Mode | <p>Displays the trust mode. If a packet's CoS tag and DSCP tag are mapped to different queues, the Trust Mode determines the queue to which the packet is assigned. Possible values are:</p> <ul style="list-style-type: none"> • CoS, which sets trust mode to CoS on the device and the CoS mapping determined the packet queue. • DSCP, sets trust mode to the DSCP on the device. The DSCP mapping determines the packet queue. |
|-------------------|---|

4.8.6 Advanced Mode

Advanced QoS mode (see figure 4-42) provides rules for specifying flow classification and assigning rule actions that relate to bandwidth management. The rules are based on the **Access Control Lists** (see Access Control Tab).

The screenshot displays the 'Advanced Mode' configuration page for QoS. The top navigation bar includes 'Setup', 'Port Config', 'VLAN Config', 'Statistics', 'ACL', 'Security', 'QoS', 'Spanning Tree', 'Multicast', 'SNMP', 'Admin', and 'LogOut'. Below this, a sub-menu shows 'CoS Settings', 'Queue Settings', 'DSCP Settings', 'Bandwidth', 'Basic Mode', and 'Advanced Mode'. The main content area is titled 'Policy Settings' and features a button for 'Out of Profile DSCP Assignments'. On the left, there are checkboxes for 'Class Map', 'Action', and 'Police', along with a 'Type' dropdown set to 'Single'. The 'Aggregate Policer' section includes input fields for 'Ingress Committed Information Rate (CIR)' (3 kbps per Second) and 'Ingress Committed Burst Size (CBS)' (3000 Bytes), and an 'Exceed Action' dropdown set to 'None'. On the right, there are buttons for 'Policy Settings', 'Class Map Settings', and 'Aggregate Policer Settings'. A 'Trust' dropdown is set to 'CoS-DSCP', and a 'Set DSCP' section has a 'New Value' input field. At the bottom, a 'Policy Content' table is shown with columns: '# Class-Map', 'Trust Set', 'Attribute Set', 'Value', 'Type', 'Aggregate Policer Name', 'CIR', 'CBS', 'Exceed Action', and 'Remove'. A 'View Interface to Policy' button is located at the bottom left, and 'Save Config' and 'Cancel Config' buttons are at the bottom right.

Figure 4-42 Advance Mode screen

MAC ACLs and **IP ACLs** can be grouped together in more complex structures, called policies. Policies can be applied to an interface. Policy ACLs are applied in the sequence they appear within the policy. Only a single policy can be attached to a port.

In advanced QoS mode, ACLs can be applied directly to an interface in the Security -ACL Binding. However, a policy and ACL cannot be simultaneously applied to an interface.

After assigning packets to a specific queue, services such as configuring output queues for the scheduling scheme, or configuring output shaping for burst size, CIR, or CBS per interface or per queue, can be applied.

Out of Profile DSCP Assignments, this button opens up the DSCP Map screen. (See figure 4-43):

| DSCP In | DSCP Out | DSCP In | DSCP Out | DSCP In | DSCP Out | DSCP In | DSCP Out |
|---------|----------|---------|----------|---------|----------|---------|----------|
| 0 | 0 | 16 | 16 | 32 | 32 | 48 | 48 |
| 1 | 1 | 17 | 17 | 33 | 33 | 49 | 49 |
| 2 | 2 | 18 | 18 | 34 | 34 | 50 | 50 |
| 3 | 3 | 19 | 19 | 35 | 35 | 51 | 51 |
| 4 | 4 | 20 | 20 | 36 | 36 | 52 | 52 |
| 5 | 5 | 21 | 21 | 37 | 37 | 53 | 53 |
| 6 | 6 | 22 | 22 | 38 | 38 | 54 | 54 |
| 7 | 7 | 23 | 23 | 39 | 39 | 55 | 55 |
| 8 | 8 | 24 | 24 | 40 | 40 | 56 | 56 |
| 9 | 9 | 25 | 25 | 41 | 41 | 57 | 57 |
| 10 | 10 | 26 | 26 | 42 | 42 | 58 | 58 |
| 11 | 11 | 27 | 27 | 43 | 43 | 59 | 59 |
| 12 | 12 | 28 | 28 | 44 | 44 | 60 | 60 |
| 13 | 13 | 29 | 29 | 45 | 45 | 61 | 61 |
| 14 | 14 | 30 | 30 | 46 | 46 | 62 | 62 |
| 15 | 15 | 31 | 31 | 47 | 47 | 63 | 63 |

Figure 4-43 Out of Profile DSCP Assignments screen

The page contains the following fields:

| | |
|-----------------|--|
| DSCP In | This displays the DSCP In value. The value is form 0-63 . |
| DSCP Out | This displays the current DSCP out value. A new value can be selected from the pull-down menu. |

The **Policy Settings** button opens the Policy Name screen (see figure 4-44):

Policy Name

Policy Name

Policy Name

Figure 4-44 Policy Settings screen

The page contains the following fields:

| | |
|------------------------|---|
| Policy Name | Defines a new Policy name. |
| Add to List | This button will add the policy to the Policy Name table. |
| Select Policy | This selects an existing Policy by name. |
| New Policy Name | Which defines a new Policy name. |
| Class Map | Where selects an existing Class Map by name. |

■ Class Map setting

New Class Map, by which the New Class Map button opens the New Class Map screen (see figure 4-45)

Figure 4-45 Class Map Settings screen

The page contains the following fields:

| | |
|-----------------------|---|
| Class Map Name | defines a new Class Map name. |
| Preferred ACL | <p>which indicates if packets are first matched to an IP based ACL or a MAC based ACL, the possible field values are:</p> <ul style="list-style-type: none"> • IP Based ACLs, matches packets to IP based ACLs first, then matches packets to MAC based ACLs. • MAC Based ACLs, matches packets to MAC based ACLs first, then matches packets to IP based ACLs. |
| IP ACL | Matches packets to IP based ACLs first, and then matches packets to MAC based ACLs. |
| Match | <p>Criteria used to match IP addresses and /or MAC addresses with an ACL's address. The possible field values are:</p> <ul style="list-style-type: none"> • And, both the MAC-based and the IP-based ACL must match a packet. • Or, either the MAC-based or the IP-based ACL must match a packet. |
| MAC ACL | Matches packets to MAC based ACLs and to IP based ACLs. |

Aggregate Policer, where user-defined aggregate policers. The Aggregate Policer button opens the New Aggregate Policer screen.

■ Aggregate Policer Setting

New Aggregate Policer screen (see figure 4-46):

Figure 4-46 Aggregate Policer Settings screen

The page contains the following fields:

| | |
|---|---|
| Aggregate Policer Name | Where enter a name in this field. |
| Ingress Committed Information Rate (CIR) | This defines the CIR in bits per second. This field is only relevant when the Police value is Single. |
| Ingress Committed Burst Size (CBS) | This defines the CBS in bytes per second. This field is only relevant when the Police value is Single. |
| Exceed Action | <p>Action assigned to incoming packets exceeding the CIR.</p> <p>This field is only relevant when the Police value is Single. Possible values are:</p> <ul style="list-style-type: none"> • Drop, which drops packets exceeding the defined CIR value. • Remark DSCP, where remarks packet's DSCP values exceeding the defined CIR value. • None, forwarding packets exceeding the defined CIR value. |

4.9. Spanning Tree

■ Theory of Spanning Tree Protocol

The IEEE 802.1D Spanning Tree Protocol and IEEE 802.1W Rapid Spanning Tree Protocol allow for the blocking of links between switches that form loops within the network. When multiple links between switches are detected, a primary link is established. Duplicated links are blocked from use and become standby links. The protocol allows for the duplicate links to be used in the event of a failure of the primary link. Once the Spanning Tree Protocol is configured and enabled, primary links are established and duplicated links are blocked automatically. The reactivation of the blocked links (at the time of a primary link failure) is also accomplished automatically without operator intervention.

This automatic network reconfiguration provides maximum uptime to network users. However, the concepts of the Spanning Tree Algorithm and protocol are a complicated and complex subject and must be fully researched and understood. It is possible to cause serious degradation of the performance of the network if the Spanning Tree is incorrectly configured. Please read the following before making any changes from the default values.

The Switch STP performs the following functions:

- Creates a single spanning tree from any combination of switching or bridging elements.
- Creates multiple spanning trees – from any combination of ports contained within a single switch, in user specified groups.
- Automatically reconfigures the spanning tree to compensate for the failure, addition, or removal of any element in the tree.
- Reconfigures the spanning tree without operator intervention.

Bridge Protocol Data Units

For STP to arrive at a stable network topology, the following information is used:

- The unique switch identifier.
- The path cost to the root associated with each switch port.
- The port identifier.

STP communicates between switches on the network using Bridge Protocol Data Units (BPDUs). Each BPDU contains the following information:

- The unique identifier of the switch that the transmitting switch currently believes is the root switch.
- The path cost to the root from the transmitting port.
- The port identifier of the transmitting port.

The switch sends BPDUs to communicate and construct the spanning-tree topology. All switches connected to the LAN on which the packet is transmitted will receive the BPDU. BPDUs are not directly forwarded by the switch, but the receiving switch uses the information in the frame to calculate a BPDU, and, if the topology changes, initiates a BPDU transmission.

The communication between switches via BPDUs results in the following:

- One switch is elected as the root switch.
- The shortest distance to the root switch is calculated for each switch.
- A designated switch is selected. This is the switch closest to the root switch through which packets will be forwarded to the root.
- A port for each switch is selected. This is the port providing the best path from the switch to the root switch.
- Ports included in the STP are selected.

Creating a Stable STP Topology

It is to make the root port a fastest link. If all switches have STP enabled with default settings, the switch with the lowest MAC address in the network will become the root switch. By increasing the priority (lowering the priority number) of the best switch, STP can be forced to select the best switch as the root switch.

When STP is enabled using the default parameters, the path between source and destination stations in a switched network might not be ideal. For instance, connecting higher-speed links to a port that has a higher number than the current root port can cause a root-port change.

STP Port States

The BPDUs take some time to pass through a network. This propagation delay can result in topology changes where a port that transitioned directly from a Blocking state to a Forwarding state could create temporary data loops. Ports must wait for new network topology information to propagate throughout the network before starting to forward packets. They must also wait for the packet lifetime to expire for BPDU packets that were forwarded based on the old topology. The forward delay timer is used to allow the network topology to stabilize after a topology change. In addition, STP specifies a series of states a port must transition through to further ensure that a stable network topology is created after a topology change.

Each port on a switch using STP exists in one of the following five states:

- **Blocking** – the port is blocked from forwarding or receiving packets.
- **Listening** – the port is waiting to receive BPDU packets that may tell the port to go back to the blocking state.
- **Learning** – the port is adding addresses to its forwarding database, but not yet forwarding packets.
- **Forwarding** – the port is forwarding packets.
- **Disabled** – the port only responds to network management messages and must return to the blocking state first.

A port transitions from one state to another as follows:

- From initialization (switch boot) to blocking.
- From blocking to listening or to disabled.
- From listening to learning or to disabled.
- From learning to forwarding or to disabled.
- From forwarding to disabled.
- From disabled to blocking.

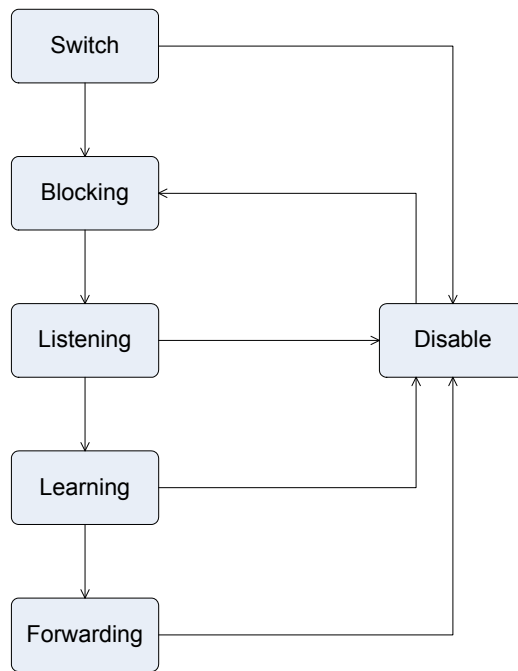

STP Port State Transitions

You can modify each port state by using management software. When you enable STP, every port on every switch in the network goes through the blocking state and then transitions through the states of listening and learning at power up. If properly configured, each port stabilizes to the forwarding or blocking state. No packets (except BPDUs) are forwarded from, or received by, STP enabled ports until the forwarding state is enabled for that port.

2. STP Parameters

STP Operation Levels

The Switch allows for two levels of operation: the switch level and the port level. The switch level forms a spanning tree consisting of links between one or more switches. The port level constructs a spanning tree consisting of groups of one or more ports. The STP operates in much the same way for both levels.



Notice

On the switch level, STP calculates the Bridge Identifier for each switch and then sets the Root Bridge and the Designated Bridges. On the port level, STP sets the Root Port and the Designated Ports.

The following are the user-configurable STP parameters for the switch level:

| Parameter | Description | Default Value |
|--|---|---------------|
| Bridge Identifier(Not user configurable except by setting priority below) | A combination of the User-set priority and the switch's MAC address. The Bridge Identifier consists of two parts: a 16-bit priority and a 48-bit Ethernet MAC address 32768 + MAC. | 32768 + MAC |
| Priority | A relative priority for each switch – lower numbers give a higher priority and a greater chance of a given switch being elected as the root bridge. | 32768 |
| Hello Time | The length of time between broadcasts of the hello message by the switch. | 2 seconds |
| Maximum Age Timer | Measures the age of a received BPDU for a port and ensures that the BPDU is discarded when its age exceeds the value of the maximum age timer. | 20 seconds |
| Forward Delay Timer | The amount time spent by a port in the learning and listening states waiting for a BPDU that may return the port to the blocking state. | 15 seconds |

The following are the user-configurable STP parameters for the port or port group level:

| Variable | Description | Default Value |
|----------------------|--|---|
| Port Priority | A relative priority for each port –lower numbers give a higher priority and a greater chance of a given port being elected as the root port. | 32768 |
| Port Cost | A value used by STP to evaluate paths – STP calculates path costs and selects the path with the minimum cost as the active path. | 19-100Mbps Fast Ethernet ports 4-1000Mbps Gigabit Ethernet ports |

Default Spanning-Tree Configuration

| Feature | Default Value |
|-----------------|---------------------------|
| Enable state | STP enabled for all ports |
| Port priority | 128 |
| Port cost | 19 |
| Bridge Priority | 32,768 |

User-Changeable STA Parameters

The Switch's factory default setting should cover the majority of installations. However, it is advisable to keep the default settings as set at the factory; unless, it is absolutely necessary. The user changeable parameters in the Switch are as follows:

Priority – A Priority for the switch can be set from 0 to 65535. 0 is equal to the highest Priority.

Hello Time – The Hello Time can be from 1 to 10 seconds. This is the interval between two transmissions of BPDU packets sent by the Root Bridge to tell all other Switches that it is indeed the Root Bridge. If you set a Hello Time for your Switch, and it is not the Root Bridge, the set Hello Time will be used if and when your Switch becomes the Root Bridge.



Notice The Hello Time cannot be longer than the Max. Age. Otherwise, a configuration error will occur.

Max. Age – The Max Age can be from 6 to 40 seconds. At the end of the Max Age, if a BPDU has still not been received from the Root Bridge, your Switch will start sending its own BPDU to all other Switches for permission to become the Root Bridge. If it turns out that your Switch has the lowest Bridge Identifier, it will become the Root Bridge.

Forward Delay Timer – The Forward Delay can be from 4 to 30 seconds. This is the time any port on the Switch spends in the listening state while moving from the blocking state to the forwarding state.



Observe the following formulas when setting the above parameters:

Max. Age $\geq 2 \times$ (Forward Delay - 1 second)

Max. Age $\geq 2 \times$ (Hello Time + 1 second)

Port Priority – A Port Priority can be from 0 to 255. The lower the number, the greater the probability the port will be chosen as the Root Port.

Port Cost – A Port Cost can be set from 0 to 65535. The lower the number, the greater the probability the port will be chosen to forward packets.

3. Illustration of STP

A simple illustration of three switches connected in a loop is depicted in Figure 5-7. In this example, you can anticipate some major network problems if the STP assistance is not applied. If switch A broadcasts a packet to switch B, switch B will broadcast it to switch C, and switch C will broadcast it to back to switch A ... and so on. The broadcast packet will be passed indefinitely in a loop, potentially causing a network failure. In this example, STP breaks the loop by blocking the connection between switch B and C. The decision to block a particular connection is based on the STP calculation of the most current Bridge and Port settings. Now, if switch A broadcasts a packet to switch C, then switch C will drop the packet at port 2 and the broadcast will end there. Setting-up STP using values other than the defaults, can be complex. Therefore, you are advised to keep the default factory settings and STP will automatically assign root bridges/ports and block loop connections. Influencing STP to choose a particular switch as the root bridge using the Priority setting, or influencing STP to choose a particular port to block using the

Port Priority and Port Cost settings is, however, relatively straight forward.

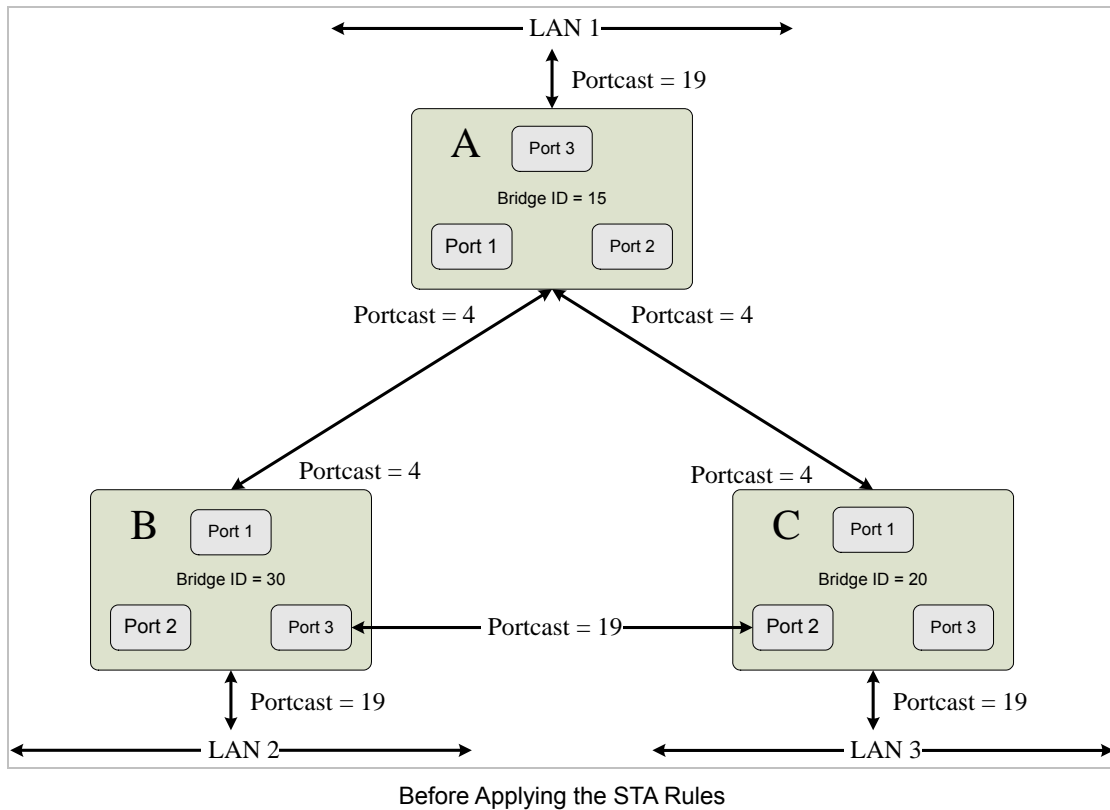

In this example, only the default STP values are used.

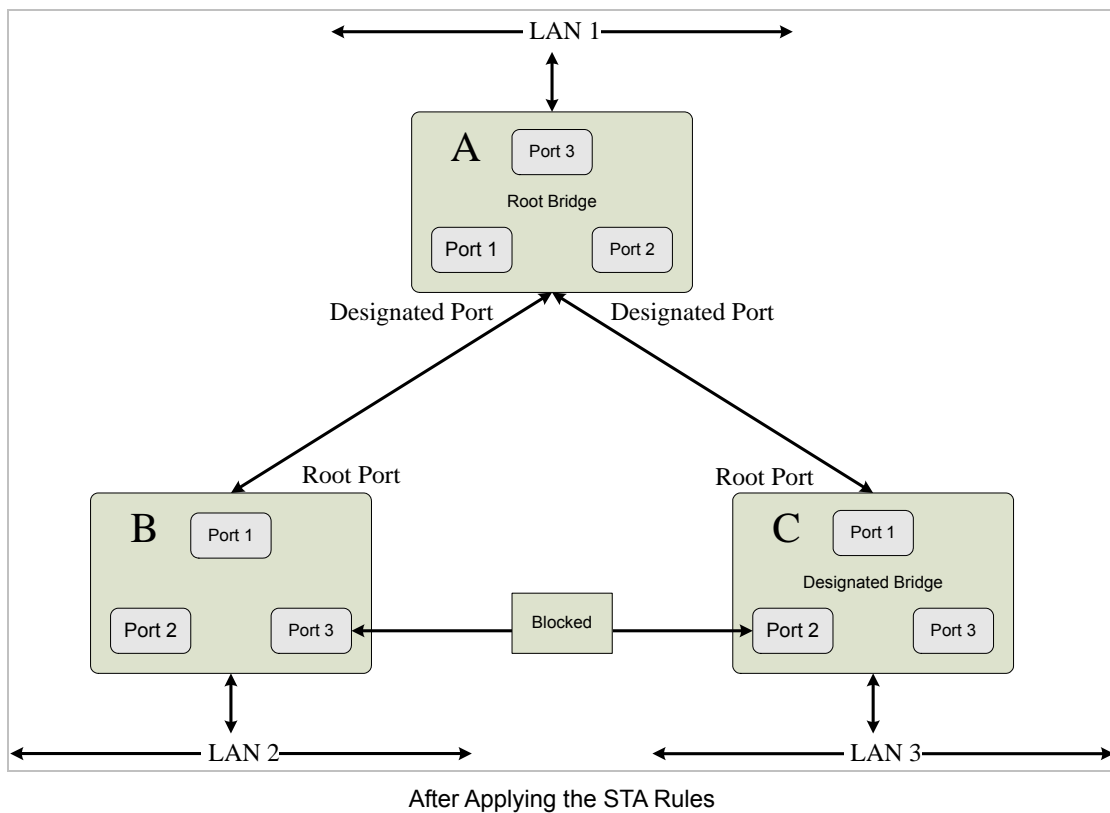

The switch with the lowest Bridge ID (switch C) was elected the root bridge, and the ports were selected to give a high port cost between switches B and C. The two (optional) Gigabit ports (default port cost = 4) on switch A are connected to one (optional) Gigabit port on both switch B and C. The redundant link between switch B and C is deliberately chosen as a 100 Mbps Fast Ethernet link (default port cost = 19). Gigabit ports could be used, but the port cost should be increased from the default to

ensure that the link between switch B and switch C is the blocked link.

■ Supported Spanning Tree Protocol of WGSD Series Switch

Spanning Tree Protocol (STP) provides tree topography for any arrangement of bridges. STP also provides one path between end stations on a network, eliminating loops.

Loops occur when alternate routes exist between hosts. Loops in an extended network can cause bridges to forward traffic indefinitely, resulting in increased traffic and reducing network efficiency.

The device supports the following Spanning Tree versions:

- **Classic STP**, by which provides a single path between end stations, avoiding and eliminating loops.
- **Rapid STP**, which detects and uses network topologies that provide faster convergence of the spanning tree, without creating forwarding loops.
- **Multiple STP**, which provides full connectivity for packets allocated to any VLAN. Multiple STP is based on the RSTP. In addition, Multiple STP transmits packets assigned to different VLANs through different MST regions. MST regions act as a single bridge.

4.9.1 STP Status

The STP Status screen (see figure 4-47) describes the STP status on the device.

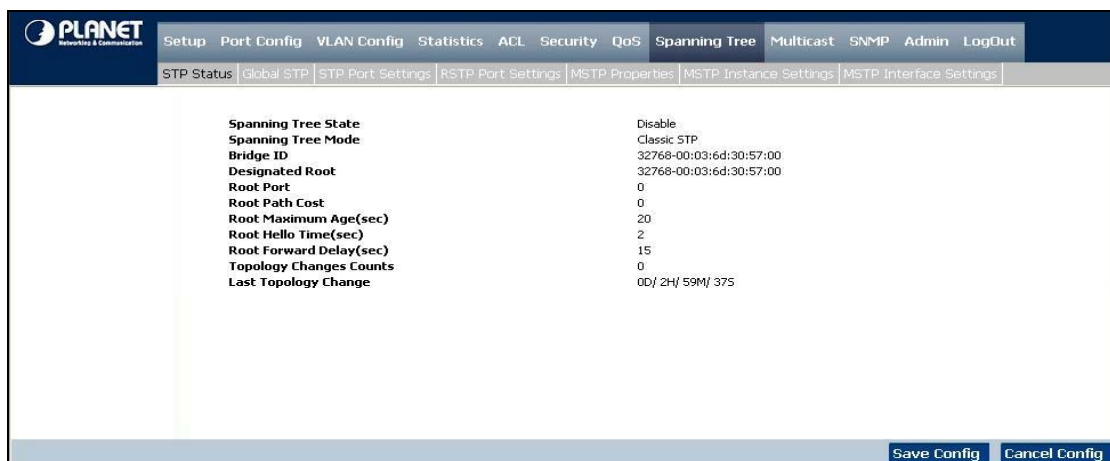

Figure 4-47 STP Status screen

The page contains the following fields:

| | |
|----------------------------|--|
| Spanning Tree State | By which indicates if STP is enabled on the device. |
| Spanning Tree Mode | By which indicates the STP mode by which STP is enabled on the device. |
| Bridge ID | Where identifies the Bridge priority and MAC address. |
| Designated Root | This indicates the ID of the bridge with the lowest path cost to the instance ID. |
| Root Port | Where indicates the port number that offers the lowest cost path from this bridge to the Root Bridge. It is significant when the Bridge is not the Root. The default is 0. |
| Root Path Cost | Where the cost of the path from this bridge to the root. |

- Root Maximum Age (sec)** This indicates the device Maximum Age Time. The Maximum Age Time indicates the amount of time in seconds a bridge waits before sending configuration messages. The default max age is **20** seconds. The range is 6 to 40 seconds.
- Root Hello Time (sec)** This indicates the device Hello Time. The Hello Time indicates the amount of time in seconds a root bridge waits between configuration messages. The default is **2** seconds. The range is 1 to 10 seconds.
- Root Forward delay (sec)** This indicates the device forward delay time. The Forward Delay Time indicates the amount of time in seconds a bridge remains in a listening and learning state before forwarding packets. The default is **15** seconds. The range is 4 to 30 seconds.
- Topology Changes Counts** This indicates the total amount of STP state changes that have occurred.
- Last Topology Change** Which indicates the amount of time that has elapsed since the bridge was initialized or reset, and the last topographic change occurred. The time is displayed in a day hour minute second format, for example, 2 days 5 hours 10 minutes and 4 seconds.

4.9.2 The Global STP

The Global STP screen (see figure 4-48) contains parameters for enabling STP on the device. Global Setting Spanning Tree State, which indicates if STP is enabled on the device.

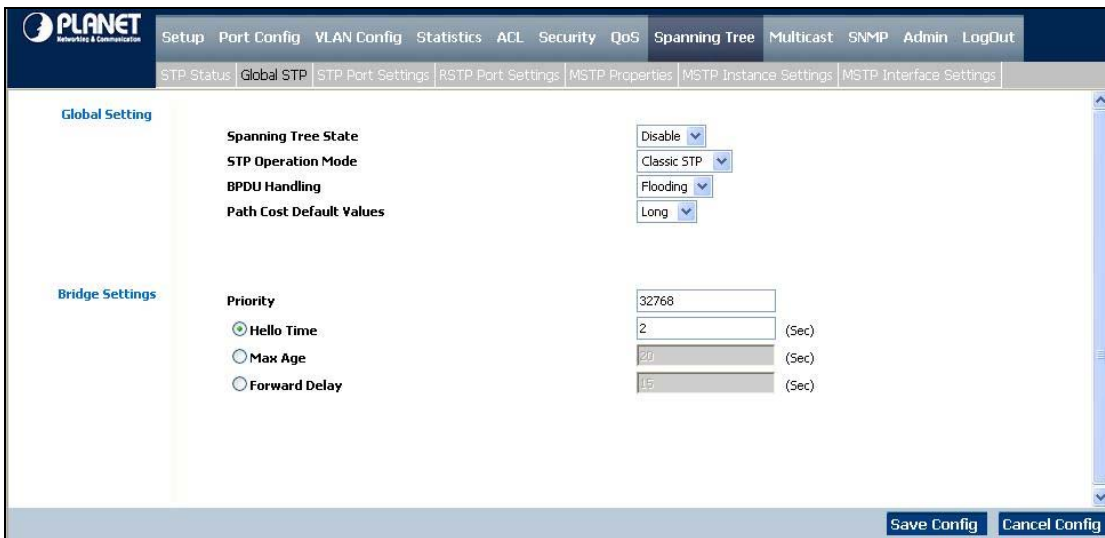

Figure 4-48 Global STP screen

The page contains the following fields:

■ Global Setting

| | |
|---------------------------------|--|
| STP Operation Mode | <p>This indicates the STP mode by which STP is enabled on the device. The possible field values are:</p> <ul style="list-style-type: none"> • Classic STP, where enables Classic STP on the device. This is the default value. • Rapid STP, where enables Rapid STP on the device. • Multiple STP, where enables Multiple STP on the device. |
| BPDU Handling | <p>This determines how BPDU packets are managed when STP is disabled on the port/ device. BPDUs are used to transmit spanning tree information. The possible field values are:</p> <ul style="list-style-type: none"> • Filtering, where filters BPDU packets when spanning tree is disabled on an interface. This is the default value. • Flooding, where floods BPDU packets when spanning tree is disabled on an interface. |
| Path Cost Default Values | <p>This specifies the method used to assign default path costs to STP ports. The possible field values are:</p> <ul style="list-style-type: none"> • Short, specifies 1 through 65,535 range for port path costs. This is the default value. • Long, specifies 1 through 200,000,000 range for port path costs. The default path costs assigned to an interface varies according to the selected method. |

■ Bridge Settings

| | |
|------------------------|---|
| • Priority | <p>Specifies the bridge priority value. When switches or bridges are running STP, each is assigned a priority. After exchanging BPDUs, the device with the lowest priority value becomes the Root Bridge.</p> <p>The port priority value is provided in increments of 4096. For example, 4096, 8192, 12288, etc. The range is 0 to 65535.</p> <p>The default value is 32768.</p> |
| • Hello Time | <p>This specifies the device Hello Time. The Hello Time indicates the amount of time in seconds a root bridge waits between configuration messages.</p> <p>The default is 2 seconds. The range is 1 to 10 seconds.</p> |
| • Max Age | <p>Where specifies the device Maximum Age Time. The Maximum Age Time indicates the amount of time in seconds a bridge waits before sending configuration messages.</p> <p>The default max age is 20 seconds. The range is 6 to 40 seconds.</p> |
| • Forward Delay | <p>This specifies the device forward delay time. The Forward Delay Time indicates the amount of time in seconds a bridge remains in a listening and learning state before forwarding packets.</p> <p>The default is 15 seconds. The range is 4 to 30 seconds.</p> |

4.9.3 STP Port Settings

Network administrators can assign STP settings to specific interfaces using the STP Interface Settings screen (see figure 4-49).

The STP Interface Settings page contains the following fields:

Figure 4-49 STP Port Settings screen

The page contains the following fields:

| | |
|-------------------|--|
| Interface | Indicates the port or LAG on which STP is enabled. |
| STP | which indicates if STP is enabled on the port. |
| Port Fast | Indicates if Fast Link is enabled on the port. If Fast Link mode is enabled for a port, the Port State is automatically placed in the Forwarding state when the port link is up. Fast Link optimizes the STP protocol convergence. STP convergence can take 30-60 seconds in large networks. |
| Port State | Displays the current STP state of a port. If enabled, the port state determines what forwarding action is taken on traffic. Possible port states are: <ul style="list-style-type: none"> • Disabled, indicates that STP is currently disabled on the port. The port forwards traffic while learning MAC addresses. • Blocking, where indicates that the port is currently blocked and cannot forward traffic or learn MAC addresses. Blocking is displayed when Classic STP is enabled. • Listening, where indicates that the port is in Listening mode. The port cannot forward traffic nor can it learn MAC addresses. • Learning, where indicates that the port is in whose mode. The port cannot forward traffic, however it can learn new MAC addresses. • Forwarding, the port that can forward traffic and learn new MAC addresses. |
| Speed | Indicates the speed at which the port is operating. |

| | |
|-----------------------------|---|
| Path Cost | Indicates the port contribution to the root path cost. The path cost is adjusted to a higher or lower value, and is used to forward traffic when a path being rerouted. Value Range : 1-20000000. Default Path Cost - The default path cost of the port is automatically set by the port speed and the default path cost method. The default values for path costs are: - Ethernet - 2000000 - Fast Ethernet - 200000 - Gigabit Ethernet - 20000 |
| Default Path Cost | When selected the default path cost is implemented. |
| Priority | Indicates priority value of the port. The priority value influences the port choice when a bridge has two ports connected in a loop. The priority value is between 0 -240. The priority value is provided in increments of 16. |
| Designated Bridge ID | Indicates the bridge priority and the MAC Address of the designated bridge. |
| Designated Port ID | Indicates the selected port's priority and interface. |
| Designated Cost | Where indicates the cost of the port participating in the STP topology. Ports with a lower cost are less likely to be blocked if STP detects loops. |
| Forward Transitions | This indicates the number of times the port has changed from the Blocking state to Forwarding state. |

■ STP Port status table

Setup Port Config VLAN Config Statistics ACL Security QoS **Spanning Tree** Multicast SNMP Admin LogOut

STP Status Global STP **STP Port Settings** RSTP Port Settings MSTP Properties MSTP Instance Settings MSTP Interface Settings

<<Previous 1 2 Next>>

| Port | STP | Port Fast | Port State | Port Role | Speed | Path Cost | Priority | Designated Bridge ID | Designated Port ID | Designated Cost | Forward Transitions |
|------|---------|-----------|------------|------------|-------|-----------|----------|----------------------|--------------------|-----------------|---------------------|
| g13 | Enabled | Disabled | Disabled | Designated | 1000M | 2000000 | 128 | N/A | N/A | N/A | N/A |
| g14 | Enabled | Disabled | Disabled | Designated | 1000M | 2000000 | 128 | N/A | N/A | N/A | N/A |
| g15 | Enabled | Disabled | Disabled | Designated | 1000M | 2000000 | 128 | N/A | N/A | N/A | N/A |
| g16 | Enabled | Disabled | Disabled | Designated | 1000M | 2000000 | 128 | N/A | N/A | N/A | N/A |
| g17 | Enabled | Disabled | Disabled | Designated | 1000M | 2000000 | 128 | N/A | N/A | N/A | N/A |
| g18 | Enabled | Disabled | Disabled | Designated | 1000M | 2000000 | 128 | N/A | N/A | N/A | N/A |
| g19 | Enabled | Disabled | Disabled | Designated | 1000M | 2000000 | 128 | N/A | N/A | N/A | N/A |
| g20 | Enabled | Disabled | Disabled | Designated | 1000M | 2000000 | 128 | N/A | N/A | N/A | N/A |
| g21 | Enabled | Disabled | Disabled | Designated | 1000M | 2000000 | 128 | N/A | N/A | N/A | N/A |
| g22 | Enabled | Disabled | Disabled | Designated | 1000M | 2000000 | 128 | N/A | N/A | N/A | N/A |
| g23 | Enabled | Disabled | Disabled | Designated | 1000M | 2000000 | 128 | N/A | N/A | N/A | N/A |
| g24 | Enabled | Disabled | Disabled | Designated | 1000M | 2000000 | 128 | N/A | N/A | N/A | N/A |

| Global System LAGs | | | | | | | | | | | |
|--------------------|--------|-----------|----------|------------|-----------|----------|----------------------|--------------------|-----------------|---------------------|--|
| LAG | STP | Port Fast | State | Port Role | Path Cost | Priority | Designated Bridge ID | Designated Port ID | Designated Cost | Forward Transitions | |
| LAG1 | Enable | Disabled | Disabled | Designated | 20000 | 128 | N/A | N/A | N/A | N/A | |
| LAG2 | Enable | Disabled | Disabled | Designated | 20000 | 128 | N/A | N/A | N/A | N/A | |
| LAG3 | Enable | Disabled | Disabled | Designated | 20000 | 128 | N/A | N/A | N/A | N/A | |
| LAG4 | Enable | Disabled | Disabled | Designated | 20000 | 128 | N/A | N/A | N/A | N/A | |
| LAG5 | Enable | Disabled | Disabled | Designated | 20000 | 128 | N/A | N/A | N/A | N/A | |
| LAG6 | Enable | Disabled | Disabled | Designated | 20000 | 128 | N/A | N/A | N/A | N/A | |
| LAG7 | Enable | Disabled | Disabled | Designated | 20000 | 128 | N/A | N/A | N/A | N/A | |
| LAG8 | Enable | Disabled | Disabled | Designated | 20000 | 128 | N/A | N/A | N/A | N/A | |

Save Config Cancel Config

Figure 4-50 STP Port status screen

4.9.4 RSTP Port settings

While the classic spanning tree prevents Layer 2 forwarding loops in a general network topology, convergence can take between 30-60 seconds. This time may delay detecting possible loops, and propagating status topology changes. Rapid Spanning Tree Protocol (RSTP) detects and uses network topologies that allow a faster STP convergence without creating forwarding loops (refer to figure 4-51).

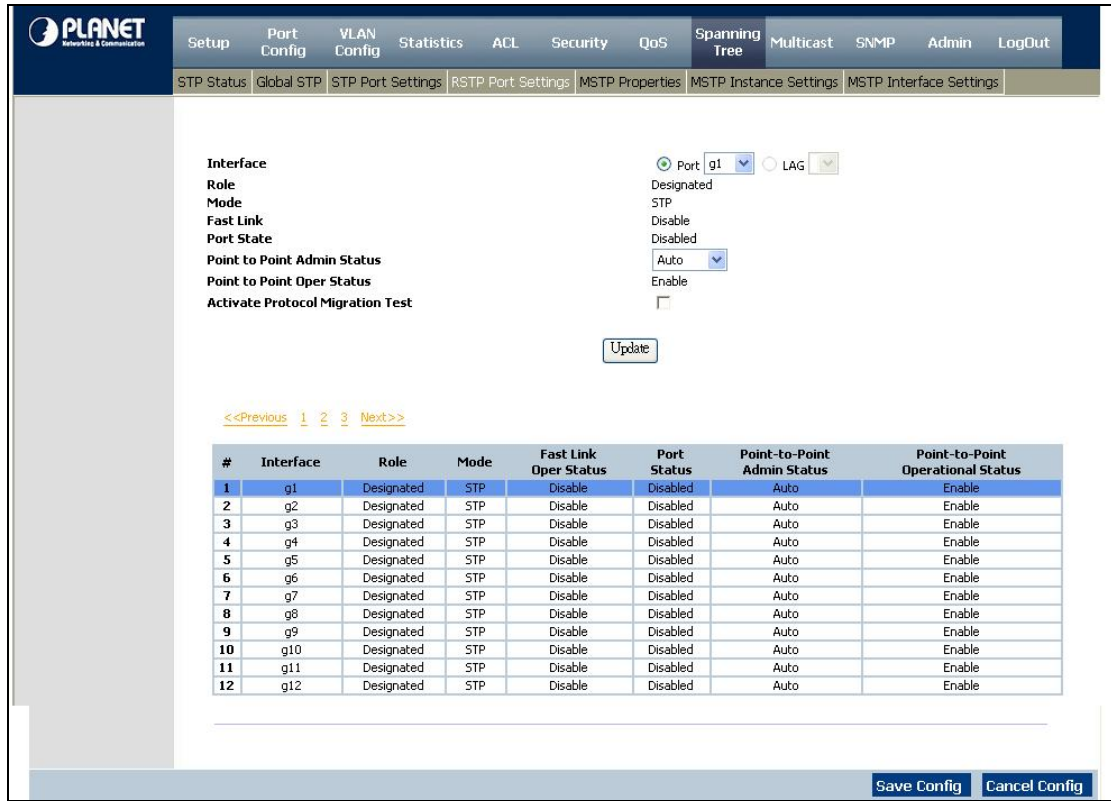

Figure 4-51 RSTP Port Settings screen

The page contains the following fields:

-
- Interface** Where displays the port or LAG on which Rapid STP is enabled.

 - Role** Where indicates the port role assigned by the STP algorithm in order to provide to STP paths. The possible field values are:
 - **Root**, where provides the lowest cost path to forward packets to root switch.
 - **Designated**, where indicates that the port or LAG via which the designated switch is attached to the LAN.
 - **Alternate**, which provides an alternate path to the root switch from the root interface.
 - **Backup**, which provides a backup path to the designated port path toward the Spanning Tree leaves. Backup ports occur only when two ports are connected in a loop by a point-to-point link. Backup ports also occur when a LAN has two or more connections connected to a shared segment.
 - **Disabled**, which indicates the port is not participating in the Spanning Tree.

 - Mode** Where indicates the current Spanning Tree mode. The Spanning Tree mode is selected in the Global STP screen. The possible field values are:
 - **Classic STP**, which indicates that Classic STP is enabled on the device.

- **Rapid STP**, which indicates that Rapid STP is enabled on the device.
- **Multiple STP**, which indicates that Multiple STP is enabled on the device.

Fast Link This indicates if Fast Link is enabled or disabled for the port or LAG. If Fast Link is enabled for a port, the port is automatically placed in the forwarding state.

Port State Indicates if RSTP is enabled on the interface.

Point-to-Point Admin Status Indicates if a point-to-point links are established, or permits the device to establish a point-to-point link. The possible field values are:

- **Auto**. Point-to-point links are automatically established by the device.
- **Enabled**, enables the device to establish a point-to-point link.
- **Disabled**, where disables point-to-point link.

Point-to-Point Oper Status Indicates the Point-to-Point operating state. To run a migration test, press Activate next to the Activate Protocol Migration Test field. The test sends Link Control Protocol (LCP) packets to test if a data link is enabled.



Notice To establish communications over a point-to-point link, the originating PPP first sends Link Control Protocol (LCP) packets to configure and test the data link. After a link is established and optional facilities are negotiated as needed by the LCP, the originating PPP sends Network Control Protocols (NCP) packets to select and configure one or more network layer protocols. When each of the chosen network layer protocols has been configured, packets from each network layer protocol can be sent over the link. The link remains configured for communications until explicit LCP or NCP packets close the link, or until some external event occurs. This is the actual switch port link type. It may differ from the administrative state.

4.9.5 MSTP Properties

MSTP provides differing load balancing scenarios. For example, while port A is blocked in one STP instance, the same port is placed in the Forwarding State in another STP instance. The MSTP Properties screen (see figure 4-52) contains information for defining global MSTP settings, region names, MSTP revisions, and maximum hops.

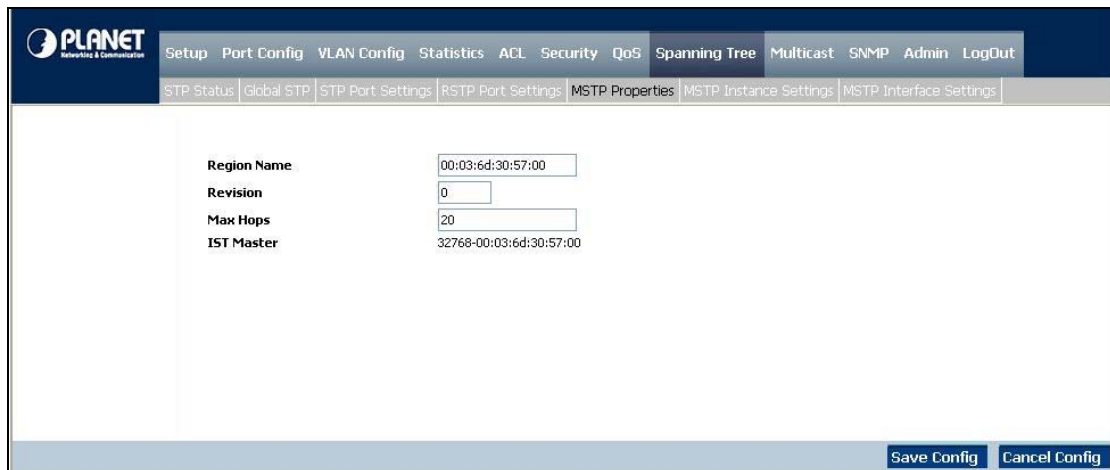

Figure 4-52 MSTP Properties

The page contains the following fields:

| | |
|--------------------|--|
| Region Name | Where provides a user-defined STP region name. |
| Revision | Where defines unsigned 16-bit number that identifies the revision of the current MST configuration. The revision number is required as part of the MST configuration. The possible field range 0-65535 . |
| Max Hops | Which indicates the total number of hops that occur in a specific region before the BPDU is discarded. Once the BPDU is discarded, the port information is aged out. The possible field range is 1-40. The field default is 20 hops. |
| IST Master | Where identifies the Spanning Tree Master instance. The IST Master is the specified instance root. |

4.9.6 MSTP Instance Settings

MSTP operation maps VLANs into STP instances (see figure 4-53) Packets assigned to various VLANs are transmitted along different paths within Multiple Spanning Trees Regions (MST Regions), Regions are one or more Multiple Spanning Tree bridges by which frames can be transmitted. In configuring MST, the MST region to which the device belongs is defined. A configuration consists of the name, revision, and region to which the device belongs.

Network Administrators can define MSTP Instances settings using the MSTP Instance Settings screen.

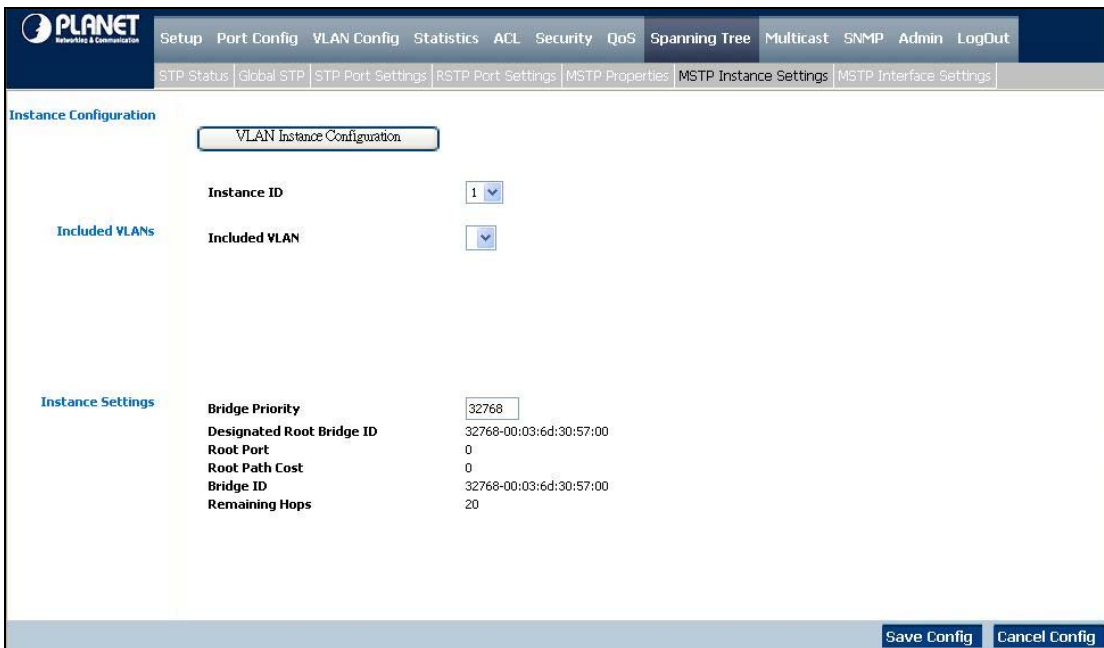

Figure 4-53 MSTP Instance Settings screen

The page contains the following fields:

■ **Instance Configuration**

Press the **VLAN Instance Configuration** button, a new window popup. Assign selected VLAN to specify MST Instance at the **VLAN Instance Configuration** page. The screen in Figure 4-54 appears.

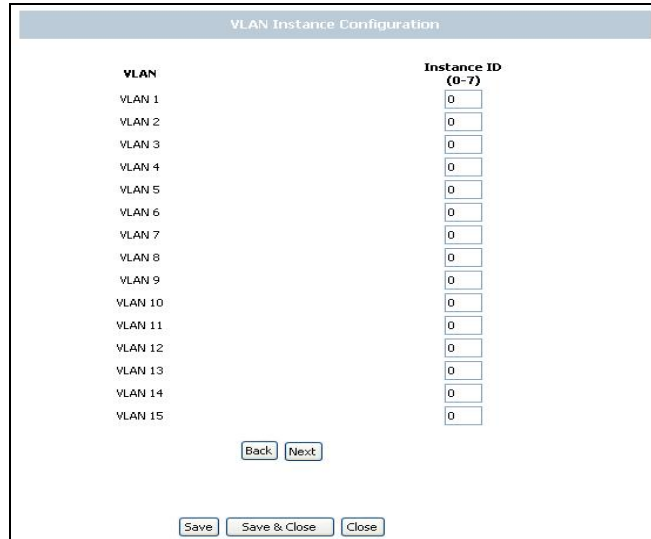

Figure 4-54 MSTP VLAN Instance Configuration screen

| | |
|--------------------|--|
| Instance ID | Defines the VLAN group to which the interface is assigned. |
|--------------------|--|

■ **Included VLANs**

| | |
|----------------------|---|
| Included VLAN | Where maps the selected VLAN to the selected instance. Each VLAN belongs to one instance. |
|----------------------|---|

■ **Instance Settings**

| | |
|------------------------|--|
| Bridge Priority | Specifies the selected spanning tree instance device priority. The field range is 0-61440. |
|------------------------|--|

| | |
|----------------------------------|--|
| Designated Root Bridge ID | which indicates the ID of the bridge with the lowest path cost to the instance ID. |
|----------------------------------|--|

| | |
|------------------|--|
| Root Port | Where indicates the selected instance's root port. |
|------------------|--|

| | |
|-----------------------|--|
| Root Path Cost | Indicates the selected instance's path cost. |
|-----------------------|--|

| | |
|------------------|---|
| Bridge ID | Indicates the bridge ID of the selected instance. |
|------------------|---|

| | |
|-----------------------|---|
| Remaining Hops | Indicates the number of hops remaining to the next destination. |
|-----------------------|---|

4.9.7 MSTP Interface Settings

Network Administrators can assign MSTP Interface settings using the MSTP Interface Settings screen (see figure 4-55).

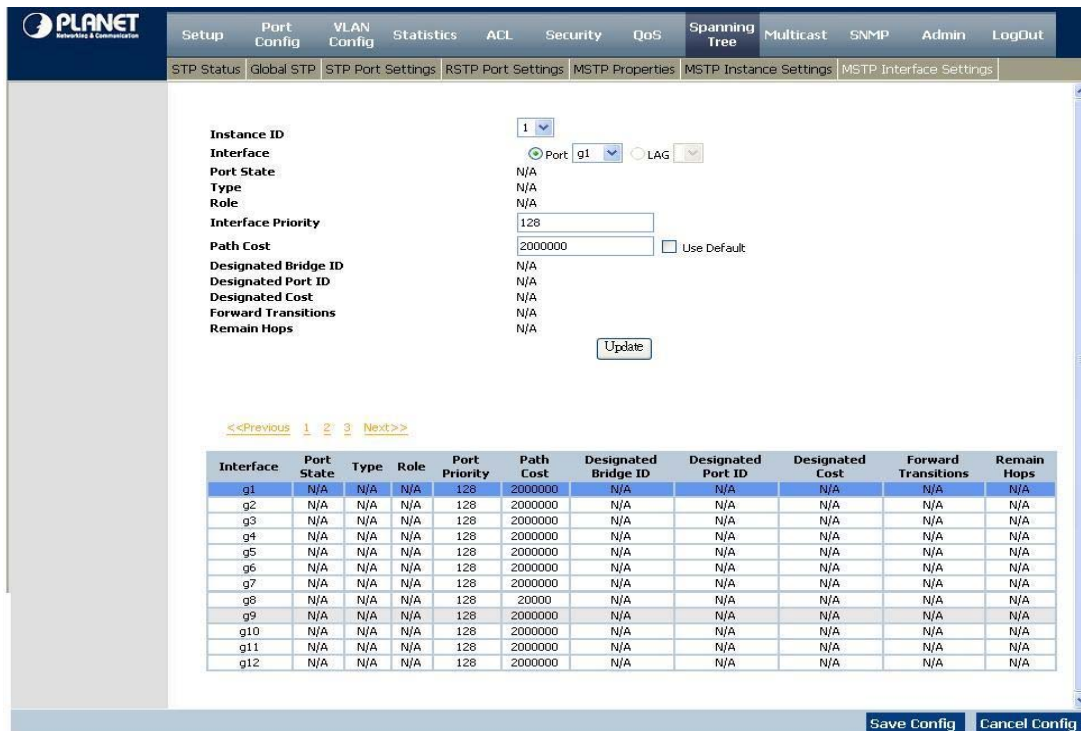

Figure 4-55 MSTP Interface Settings screen

The MSTP Interface Settings screen contains the following fields:

| | |
|---------------------------|---|
| Instance ID | Lists the MSTP instances configured on the device. Possible field range is 0-15 . |
| Interface | Indicates the interface for which the MSTP settings are displayed. The possible field values are two types: <ul style="list-style-type: none"> • Port - Specifies the port for which the MSTP settings are displayed. • LAG - Specifies the LAG for which the MSTP settings are displayed. |
| Port State | where indicates whether the port is enabled for the specific instance. |
| Type | indicates if the port is a point-to-point port, or a port connected to a hub. The possible field values are: <ul style="list-style-type: none"> • Boundary Port, attaches MST bridges to LAN in an outlying region. If the port is a boundary port, it also indicates whether the device on the other side of the link is working in RSTP or STP mode. • Master Port, where provides connectivity from a MSTP region to the outlying CIST root. • Internal, indicates the port is an internal port. |
| Role | Indicates the port role assigned by the STP algorithm in order to provide to STP paths. The possible field values are: <ul style="list-style-type: none"> • Root, provides the lowest cost path to forward packets to root device. • Designated, indicates the port or LAG via which the designated device is attached to the LAN. • Alternate, provides an alternate path to the root device from the root interface. • Backup, provides a backup path to the designated port path toward the Spanning Tree leaves. Backup ports occur only when two ports are connected in a loop by a point-to-point link. Backup ports also occur when a LAN has two or more connections connected to a shared segment. • Disabled, which indicates the port is not participating in the Spanning Tree. |
| Interface Priority | Defines the interface priority for specified instance. The default value is 128 . |

| | |
|-----------------------------|--|
| Path Cost | Indicates the port contribution to the Spanning Tree instance. The range should always be 1200,000,000. |
| Designated Bridge ID | Where indicates that the bridge ID number that connects the link or shared LAN to the root. |
| Designated Port ID | By which indicates that the Port ID number on the designated bridge that connects the link or the shared LAN to the root. |
| Designated Cost | Indicates that the default path cost is assigned according to the method selected on the Spanning Tree Global Settings screen. |
| Forward Transitions | This indicates the number of times the port has changed from the Forwarding state to Blocking state. |
| Remaining Hops | Indicates the hops remaining to the next destination. |

■ **MSTP Interface status table**

The page displays the current MST Interfaces configuration and status.

| Interface | Port State | Type | Role | Port Priority | Path Cost | Designated Bridge ID | Designated Port ID | Designated Cost | Forward Transitions | Remain Hops |
|-----------|------------|------|------|---------------|-----------|----------------------|--------------------|-----------------|---------------------|-------------|
| g1 | N/A | N/A | N/A | 128 | 2000000 | N/A | N/A | N/A | N/A | N/A |
| g2 | N/A | N/A | N/A | 128 | 2000000 | N/A | N/A | N/A | N/A | N/A |
| g3 | N/A | N/A | N/A | 128 | 2000000 | N/A | N/A | N/A | N/A | N/A |
| g4 | N/A | N/A | N/A | 128 | 2000000 | N/A | N/A | N/A | N/A | N/A |
| g5 | N/A | N/A | N/A | 128 | 2000000 | N/A | N/A | N/A | N/A | N/A |
| g6 | N/A | N/A | N/A | 128 | 2000000 | N/A | N/A | N/A | N/A | N/A |
| g7 | N/A | N/A | N/A | 128 | 2000000 | N/A | N/A | N/A | N/A | N/A |
| g8 | N/A | N/A | N/A | 128 | 20000 | N/A | N/A | N/A | N/A | N/A |
| g9 | N/A | N/A | N/A | 128 | 2000000 | N/A | N/A | N/A | N/A | N/A |
| g10 | N/A | N/A | N/A | 128 | 2000000 | N/A | N/A | N/A | N/A | N/A |
| g11 | N/A | N/A | N/A | 128 | 2000000 | N/A | N/A | N/A | N/A | N/A |
| g12 | N/A | N/A | N/A | 128 | 2000000 | N/A | N/A | N/A | N/A | N/A |

Figure 4-56 MSTP Interface configuration screen

4.10 Multicast

On this field, included IGMP Snooping, Bridge Multicast, Forward All.

About the Internet Group Management Protocol (IGMP) Snooping

Computers and network devices that want to receive multicast transmissions need to inform nearby routers that they will become members of a multicast group. The Internet Group Management Protocol (IGMP) is used to communicate this information. IGMP is also used to periodically check the multicast group for members that are no longer active. In the case where there is more than one multicast router on a sub network, one router is elected as the 'queried'. This router then keeps track of the membership of the multicast groups that have active members. The information received from IGMP is then used to determine if multicast packets should be forwarded to a given sub network or not. The router can check, using IGMP, to see if there is at least one member of a multicast group on a given subnet work. If there are no members on a sub network, packets will not be forwarded to that sub network.

IGMP Versions 1 and 2

Multicast groups allow members to join or leave at any time. IGMP provides the method for members and multicast routers to communicate when joining or leaving a multicast group.

IGMP version 1 is defined in RFC 1112. It has a fixed packet size and no optional data.

The format of an IGMP packet is shown below:

IGMP Message Format

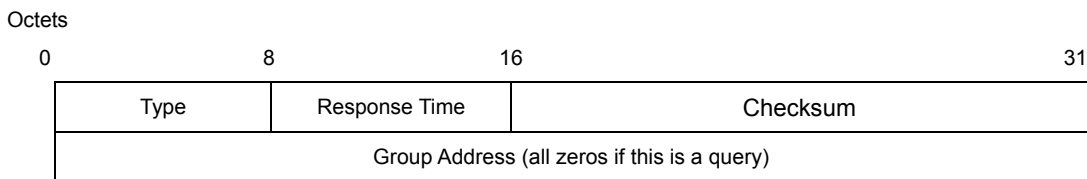

The IGMP Type codes are shown below:

| Type | Meaning |
|------|---|
| 0x11 | Membership Query (if Group Address is 0.0.0.0) |
| 0x11 | Specific Group Membership Query (if Group Address is Present) |
| 0x16 | Membership Report (version 2) |
| 0x17 | Leave a Group (version 2) |
| 0x12 | Membership Report (version 1) |

IGMP packets enable multicast routers to keep track of the membership of multicast groups, on their respective sub networks.

The following outlines what is communicated between a multicast router and a multicast group member using IGMP.

A host sends an IGMP "**report**" to join a group

A host will never send a report when it wants to leave a group (for version 1).

A host will send a "**leave**" report when it wants to leave a group (for version 2).

Multicast routers send IGMP queries (to the all-hosts group address: 224.0.0.1) periodically to see whether any group members exist on their sub networks. If there is no response from a particular group, the router assumes that there are no group members

on the network.

The Time-to-Live (TTL) field of query messages is set to 1 so that the queries will not be forwarded to other sub networks.

IGMP version 2 introduces some enhancements such as a method to elect a multicast queried for each LAN, an explicit leave message, and query messages that are specific to a given group.

The states a computer will go through to join or to leave a multicast group are shown below:

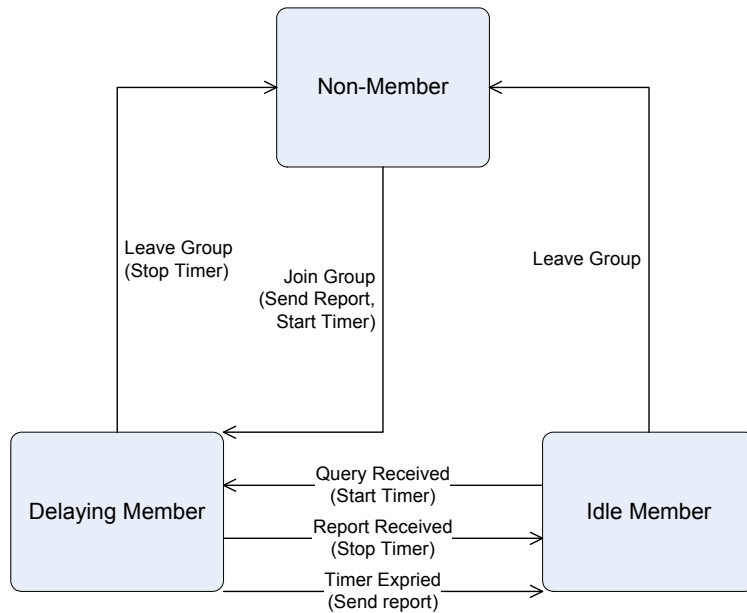

IGMP State Transitions

IGMP Snooping Configuration

The default status of the IGMP Snooping function is disabled. To turn on the IGMP Snooping, select “Enable” of the **IGMP Snooping Status** field and click on the “OK” button to save.

4.3.3.1 IGMP Configuration

The switch support IP multicast, you can enable IGMP protocol on web management's switch setting advanced page, then display the IGMP snooping information in this page, you can view difference multicast group VID and member port in here, IP multicast addresses range from 224.0.0.0 through 239.255.255.255.

The Internet Group Management Protocol (IGMP) is an internal protocol of the Internet Protocol (IP) suite. IP manages multicast traffic by using switches, routers, and hosts that support IGMP. Enabling IGMP allows the ports to detect IGMP queries and report packets and manage IP multicast traffic through the switch. IGMP have three fundamental types of message as follows:

| Message | Description |
|---------|--|
| Query | A message sent from the querier (IGMP router or switch) asking for a response from each host belonging to the multicast group. |

| | |
|--------------------|--|
| Report | A message sent by a host to the querier to indicate that the host wants to be or is a member of a given group indicated in the report message. |
| Leave Group | A message sent by a host to the querier to indicate that the host has quit to be a member of a specific multicast group. |

4.10.1 IGMP Snooping

When IGMP Snooping (see figure 4-57) is enabled globally, all IGMP packets are forwarded to the CPU. The CPU analyzes the incoming packets and determines which ports want to join which Multicast groups, which ports have Multicast routers generating IGMP queries, which routing protocols are forwarding packets and Multicast traffic. Ports requesting to join a specific Multicast group issue an IGMP report, specifying that Multicast group is accepting members. This results in the creation of the Multicast filtering database.

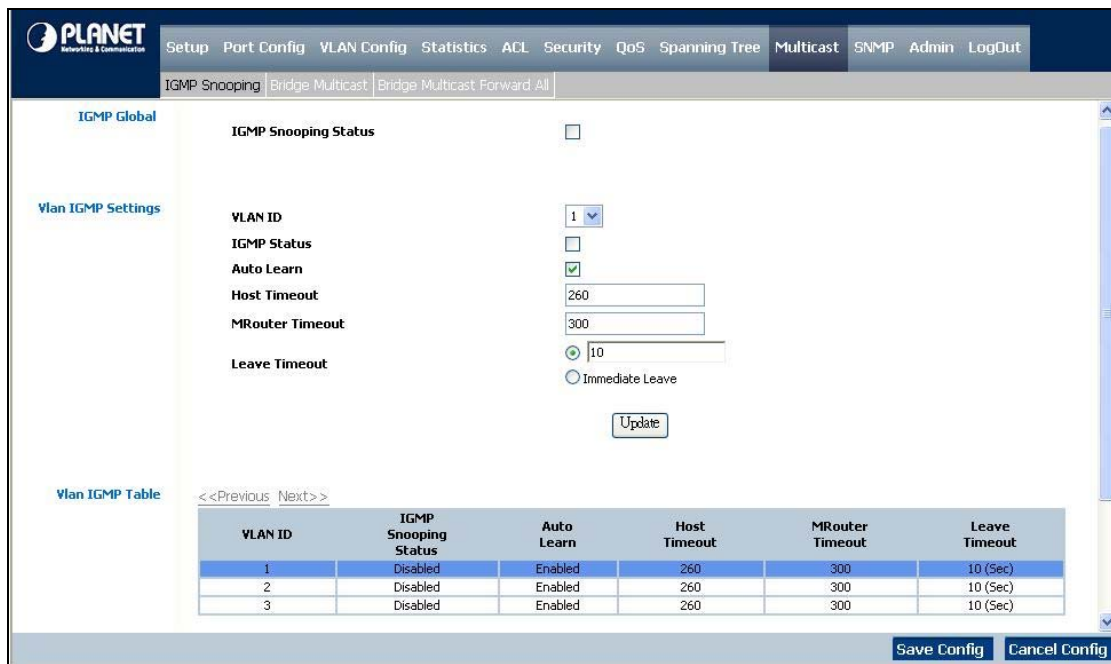

Figure 4-57 IGMP Snooping screen

The page contains the following fields:

- **IGMP Global**

IGMP Snooping Status Indicates if IGMP Snooping is **enabled** or **Disabled** on the device.

- **VLAN IGMP Settings**

VLAN ID Specifies the VLAN ID.

| | |
|------------------------|--|
| IGMP Status | Indicates if IGMP snooping is enabled on the VLAN. |
| Auto Learn | Indicates if Auto Learn is enabled on the device. If Auto Learn is enabled, the device automatically learns where other Multicast groups are located. Enables or disables Auto Learn on the Ethernet device. |
| Host Timeout | Indicates the amount of time host waits to receive a message before timing out. The default time is 260 seconds. |
| MRouter Timeout | Indicates the amount of the time the Multicast router waits to receive a message before it times out. The default value is 300 seconds. |
| Leave Timeout | Indicates the time the host waits, after requesting to leave the IGMP group and not receiving a Join message from another station, before timing out. If a Leave Timeout occurs, the switch notifies the Multicast device to stop sending traffic. The Leave Timeout value is either user-defined, or an immediate leave value. The default timeout is 10 seconds. |

 **Notice:** IGMP Snooping can be enabled only if Bridge Multicast Filtering is enabled.

4.10.2 Bridge Multicast

The Bridge Multicast screen (see figure 4-58) displays the ports and LAGs attached to the Multicast service group in the Ports and LAGs tables. The Port and LAG tables also reflect the manner in which the port or LAGs joined the Multicast group. Ports can be added either to existing groups or to new Multicast service groups.

This screen permits new Multicast service groups to be created, also assigns ports to a specific Multicast service address group, and included two areas, **Configuring Multicast** and **Multicast Table**.

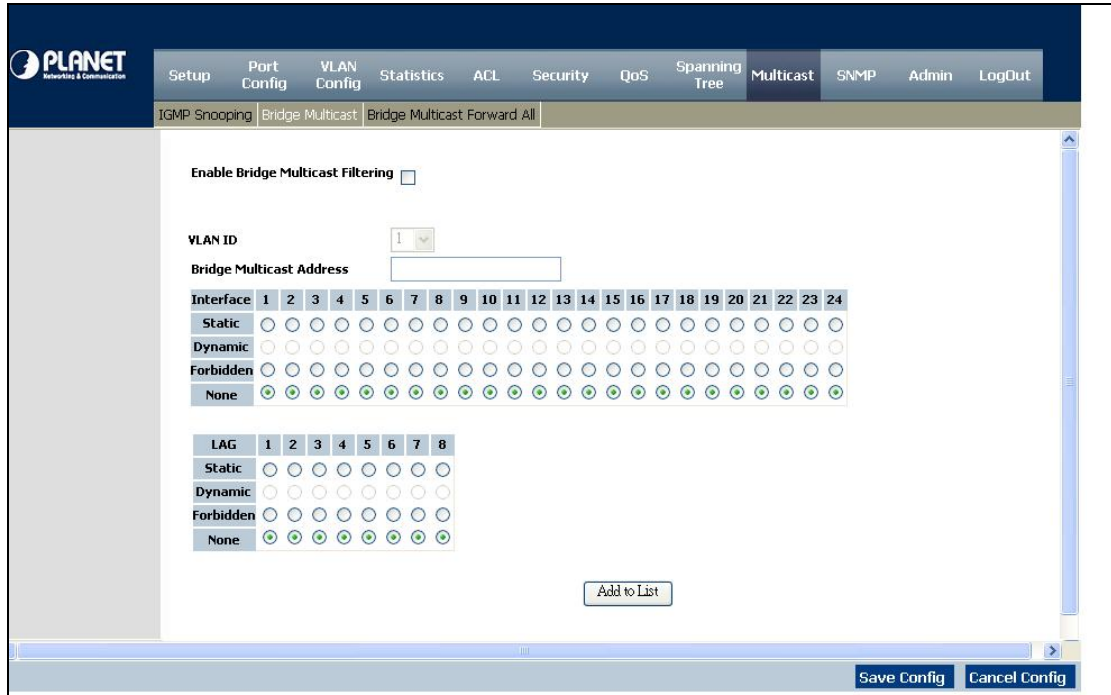

Figure 4-58 Bridge Multicast screen

The Page contains the following fields:

■ Configure Multicast

Enable Bridge Multicast Filtering

The check box allows enabling Bridge Multicast Filtering function.

VLAN ID

This identifies a VLAN to be configured to a Multicast service.

Bridge Multicast Address

Identifies the Multicast group MAC address/IP address.

Interface

Displays Interface that can be added to a Multicast service.

The configuration options are as follows:

- **Static**, indicates the port is user-defined.
- **Dynamic**, indicates the port is configured dynamically.
- **Forbidden**, forbidden ports are not included the Multicast group, even if IGMP snooping designated the port to join a Multicast group.
- **None**, displays the port is not configured for Multicast service.

LAG

Displays LAG that can be added to a Multicast service.

The fields are the same for both areas. se the **Add to List** button when you want to assigns ports to a specific Multicast service address group.

■ **Multicast Table**

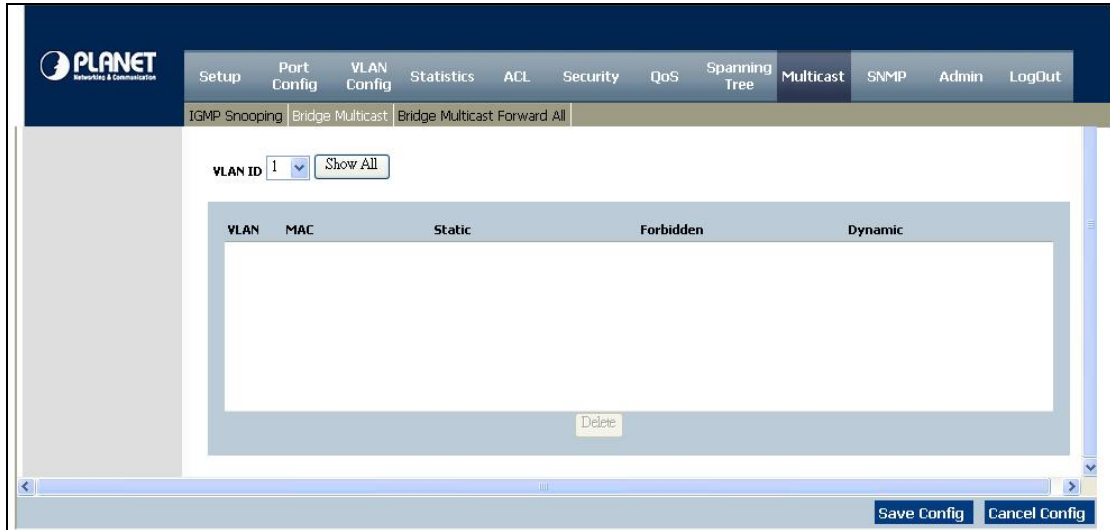

Figure 4-59 Bridge Multicast screen

Example:

■ **Adding Bridge Multicast Addresses**

1. Click the check box to enable the Bridge Multicast Filtering.
2. Define the VLAN ID and New Bridge Multicast Address fields.
3. Check a port to **Static** to join the port to the selected Multicast group.
4. Click **“Add to List”** button.
5. Click the **“Save Config”** to apply the sttings.

The bridge Multicast address is assigned to the Multicast group, and the device is updated.

■ **Defining Ports to Receive Multicast Service**

1. Define the VLAN ID and the Bridge Multicast Address fields.
2. Check and click a port to **Static** to join the port to the selected Multicast group.
3. Click **“Add to List”** button.
4. Click the **“Save Config”** to apply the sttings.
5. Select the VLAN ID to check if the entries be added.

The port is assigned to the Multicast group, and the device is updated.

■ **Assigning LAGs to Receive Multicast Service**

1. Define the VLAN ID and the Bridge Multicast Address fields.
2. Check and click the **LAG to Static** to join the port to the selected Multicast group.
3. Click **“Add to List”** button.
4. Click the **“Save Config”** to apply the sttings.

The LAG is assigned to the Multicast group, and the device is updated.

4.10.3 Bridge Multicast Forward All

The Bridge Multicast Forward All Screen contains fields for attaching ports or LAGs to a device attached to a neighboring Multicast router/switch. Once IGMP Snooping is enabled, Multicast packets are forwarded to the appropriate port or VLAN. Refer to figure 4-60.

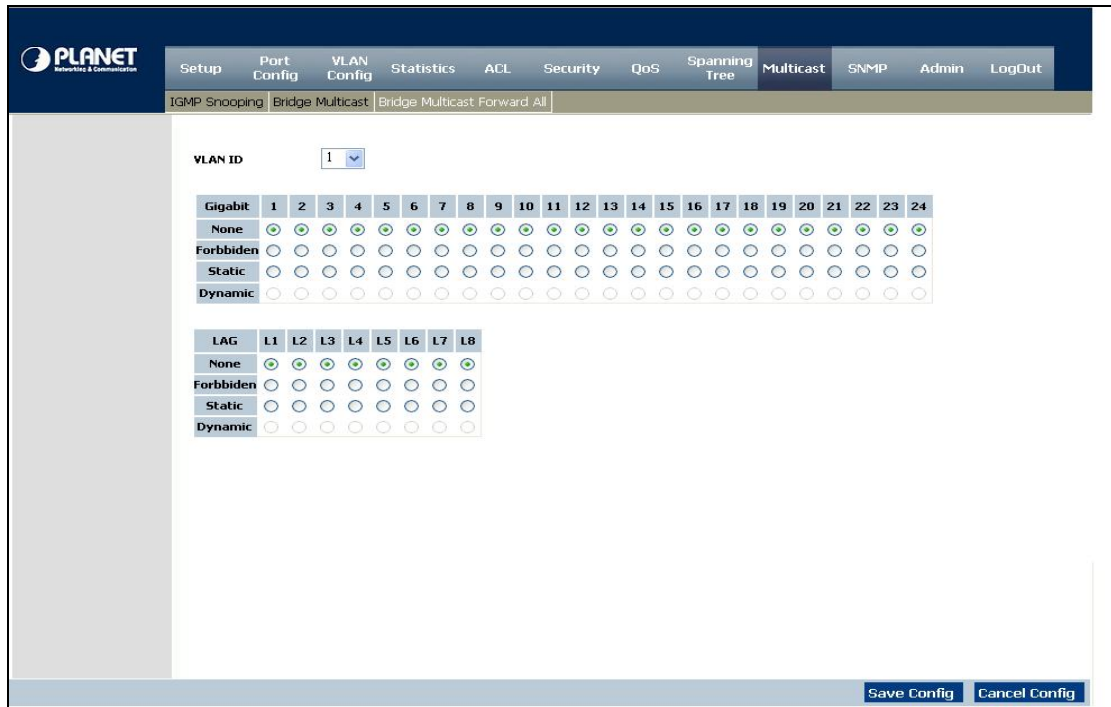

Figure 4-60 Multicast Bridge Forward All screen

The Bridge Multicast Forward All Screen contains the following fields:

| | |
|------------------|---|
| VLAN ID | For which Multicast parameters are displayed. This identifies a VLAN to be configured to a Multicast service. |
| Interface | <p>Displays Interface that can be added to a Multicast service.</p> <p>The configuration options are as follows:</p> <ul style="list-style-type: none"> • Static, indicates the port is user-defined. • Dynamic, indicates the port is configured dynamically. • Forbidden, forbidden ports are not included the Multicast group, even if IGMP snooping designated the port to join a Multicast group. • None, displays the port is not configured for Multicast service. |
| LAG | Displays LAG that can be added to a Multicast service. |

4.11 SNMP

Simple Network Management Protocol (SNMP) provides a method for managing network devices. Devices supporting SNMP run a local software (agent).

The SNMP agents maintain a list of variables, which are used to manage the device. The variables are defined in the Management Information Base (MIB). The MIB contains the variables controlled by the agent. The SNMP protocol defines the MIB specification format, as well as the format used to access the information over the network.

Access rights to the SNMP agents are controlled by access strings. To communicate with the device, the Embedded Web Server submits a valid community string for authentication.

4.11.1 Global Parameters

The Global Parameters screen (see figure 4-61) contains parameters for defining SNMP notification parameters.

Figure 4-61 SNMP Global Parameter

The Global Parameter Screen contains the following fields:

■ SNMPV3

| | |
|------------------------|---|
| Local Engine ID | Indicates the local device engine ID. The field value is a hexadecimal string. Each byte in hexadecimal character strings consists of two hexadecimal digits. Each byte can be separated by a period or a colon. The Engine ID must be defined before SNMPv3 is enabled. For stand-alone devices, select a default Engine ID that is comprised of Enterprise number and the default MAC address. For a stackable system configure the Engine ID, and verify that the Engine ID is unique for the administrative domain. This prevents two devices in a network from having the same Engine ID. |
| Use Default | Uses the device generated Engine ID. It's defined per standard as: First 4 octets — first bit = 1, the rest is IANA Enterprise number. To locate the IANA Enterprise number by referring to the Vendor website, or use the show SNMP command using a CLI interface. |

The default Engine ID is based on the **device MAC address**.

■ **Notification**

SNMP Notifications This indicates if the device can send SNMP notifications.

Authentication Notifications This indicates if SNMP Authentication failure notification is enabled on the device.

4.11.2 Views

SNMP Views provide access or block access to device features or feature aspects. For example, a view can be defined that states that SNMP Group A has Read Only (R/O) access to Multicast groups, while SNMP Group B has Read-Write (R/W) access to Multicast groups. Feature access is granted via the MIB name, or MIB Object ID (refer to figure 4-62)

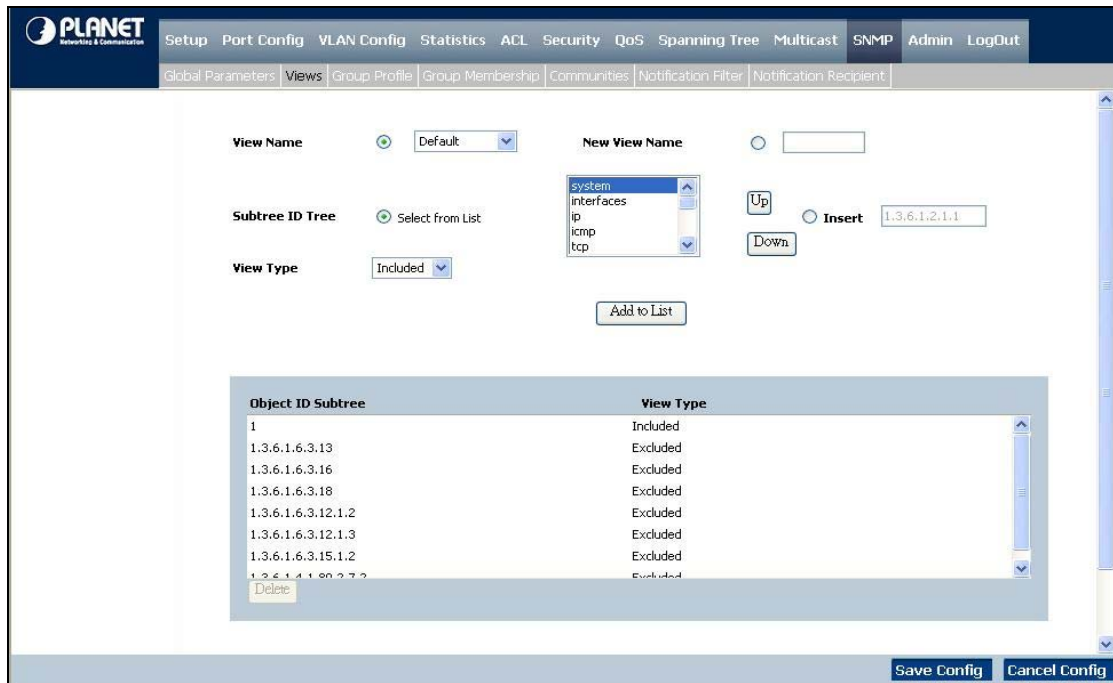
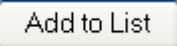

Figure 4-62 SNMP View screen

The page contains the following fields:

| | |
|-------------------------|--|
| View Name | Indicates the user-defined views. The options are as follows: <ul style="list-style-type: none"> • Default - which displays the default SNMP view for read and read/write views. • DefaultSuper - indicates the default SNMP view for administrator views. |
| Subtree ID Tree | Indicates the device feature OID included or excluded in the selected SNMP view. The options to select the following Subtree: |
| Select from List | Select the Subtree from the list provided. |
| Insert | Enables a Subtree not included in the Select from List field to be entered. |

View Type This indicates if the defined OID branch will be **included** or **excluded** in the selected SNMP view.

Use the  button when you want to add the Views configuration to the Views Table at the bottom of the screen.

4.11.3 Group Profile

The Group Profile screen (see figure 4-63) provides information for creating SNMP groups and assigning SNMP access control privileges to SNMP groups. Groups allow network managers to assign access rights to specific device features, or features aspects.

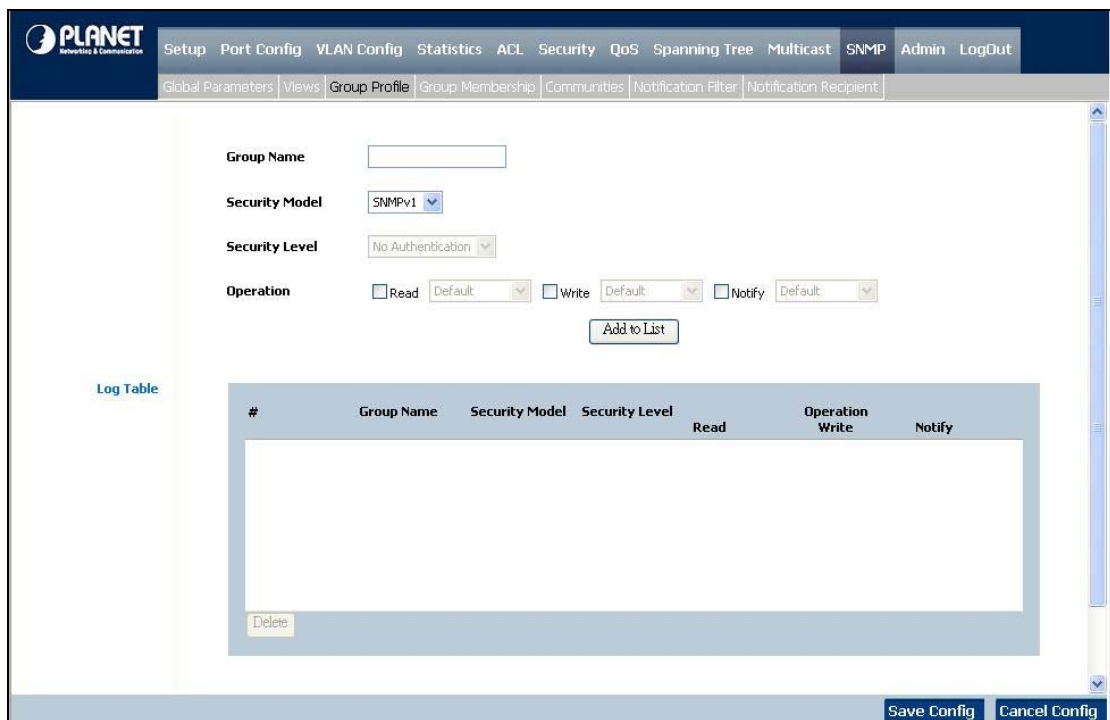

Figure 4-63 Group Profile screen

The page contains the following fields:

| | |
|-----------------------|---|
| Group Name | Displays the user-defined group to which access control rules are applied. The field range is up to 30 characters. |
| Security Model | Defines the SNMP version attached to the group. The possible field values are: <ul style="list-style-type: none"> • SNMPv1, defined for the group. • SNMPv2, defined for the group. • SNMPv3, defined for the group. |
| Security Level | Defines the security level attached to the group. Security levels apply to SNMPv3 only . The possible field values are: <ul style="list-style-type: none"> • No Authentication, which indicates that neither the Authentication nor the Privacy security levels are assigned to the group. |

- **Authentication**, which authenticates SNMP messages, and ensures the SNMP messages original is authenticated.

Privacy Where encrypts SNMP messages.

Operation Defines the group access rights. The possible field values are:

- **Read**. The management access is restricted to read-only, and changes cannot be made to the assigned SNMP view.
- **Write**. The management access is read-write and changes can be made to the assigned SNMP view.
- **Notify**. Sends traps for the assigned SNMP view.

4.11.4 Group Membership

The Group Membership screen (see figure 4-64) provides information for assigning SNMP access control privileges to SNMP groups.

Figure 4-64 Group Membership

The page contains the following fields:

User name By which provides a user-defined local user list.

Engine ID Indicates either the local or remote SNMP entity to which the user is connected. Changing or removing the local SNMP Engine ID deletes the SNMPv3 User Database.

- **Local** - Indicates that the user is connected to a local SNMP entity.
- **Remote** - Indicates that the user is connected to a remote SNMP entity. If the Engine ID is defined, remote devices receive inform messages.

| | |
|------------------------------|---|
| Group Name | Contains a list of user-defined SNMP groups. SNMP groups are defined in the SNMP Group Profile page. |
| Authentication Method | Indicates the Authentication method used. The possible field values are: <ul style="list-style-type: none"> • None, that no authentication method is used to authenticate the port. • MD5 Password, that port authentication is performed via HMAC-MD5-96 password authentication. • SHA Password, that port authentication is performed via HMAC-SHA-96 password authentication. • MD5 Key, that port authentication is performed via the HMAC-MD5 algorithm. • SHA Key, that port authentication is performed via HMAC-SHA-96 authentication. |
| Password | Define the local user password. Local user passwords can contain up to 159 characters. |
| Authentication Key | Define the HMAC-MD5-96 or HMAC-SHA-96 authentication level. The authentication and privacy keys are entered to define the authentication key. If only authentication is required, 16 bytes are defined. If both privacy and authentication are required, 32 bytes are defined. Each byte in hexadecimal character strings is two hexadecimal digits. Each byte can be separated by a period or a colon. |
| Privacy Key | Defines the Privacy Key (LSB). If only authentication is required, 20 bytes are defined. If both privacy and authentication are required, 36 bytes are defined. Each byte in hexadecimal character strings is two hexadecimal digits. Each byte can be separated by a period or colon. |

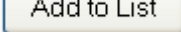
Use the  button when you want to add the Group Membership configuration to the respective table at the bottom of the screen.

4.11.5 Communities

The Communities screen contains three areas:

- **Communities**
- **Basic Table**
- **Advanced Table**

The screens in Figure 4-65 and 4-66 appears

■ Communities

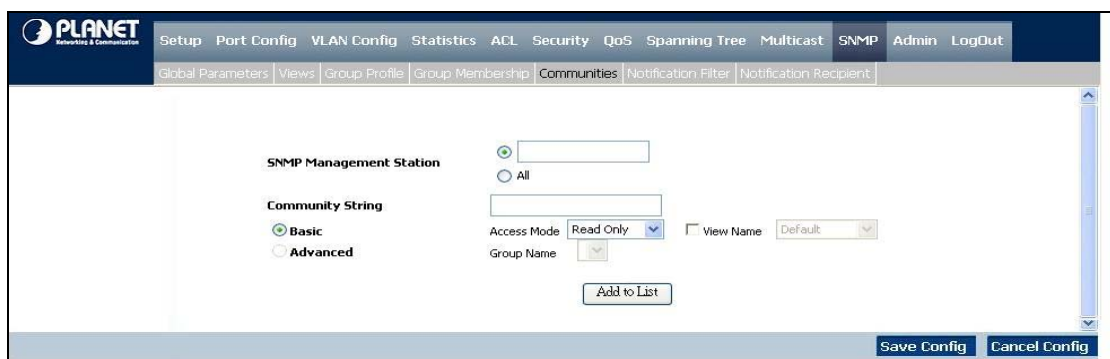
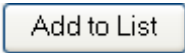

Figure 4-65 Communities configuration screen

The page contains the following fields:

| | |
|--------------------------------|--|
| SNMP Management Station | Defines the management station IP address for which the advanced SNMP community is defined. There are two definition options: <ul style="list-style-type: none"> • IP Address - Define the management station IP address. • All - which includes all management station IP addresses. |
| Community String Basic | Defines the password used to authenticate the management station to the device, which enables SNMP Basic mode for a selected community and contains the following fields: <p>Access Mode - Defines the access rights of the community. The possible field values are:</p> <ul style="list-style-type: none"> • Read Only - which indicates management access is restricted to read-only, and changes cannot be made to the community. • Read Write - management access is read-write and changes can be made to the device configuration, but not to the community. • SNMP Admin - user has access to all device configuration options, as well as permissions to modify the community. <p>View Name - contains a list of user-defined SNMP views.</p> |
| Advanced | Enables SNMP Advanced Mode for a selected community and contains the following fields: <p>Group Name - defines advanced SNMP communities group names.</p> |

Use the  button when you want to add the Communities configuration to the respective Table at the bottom of the screen.

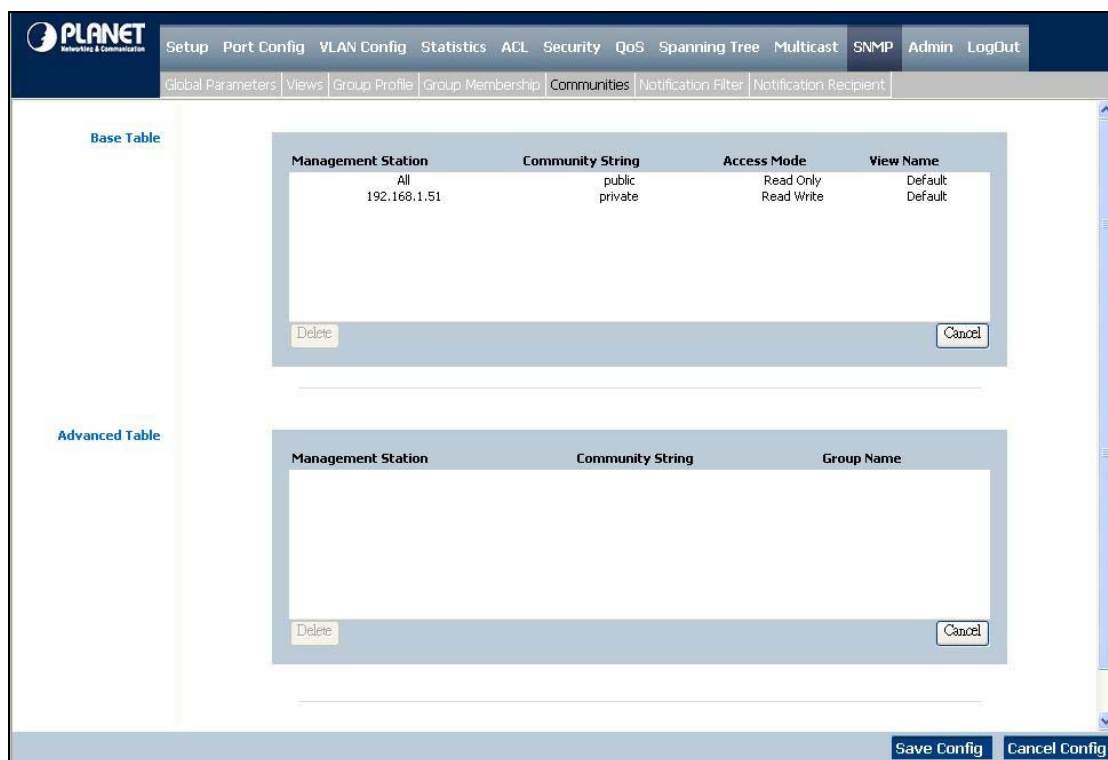

Figure 4-66 Communities table screen

■ Base Table

The page contains the following fields:

| | |
|---------------------------|---|
| Management Station | Displays the management station IP address for which the basic SNMP community is defined. |
| Community String | Displays the password used to authenticate the management station to the device. |
| Access Mode | Where displays the access rights of the community. |
| View Name | Displays the user-defined SNMP view. |

■ Advanced Table

| | |
|---------------------------|---|
| Management Station | Displays the management station IP address for which the basic SNMP community is defined. Community String, which displays the password used to authenticate the management station to the device. |
| Group Name | Displays advanced SNMP communities group name. |

4.11.6 Notification Filter

The Notification Filter screen (see figure 4-67) permits filtering traps based on OIDs. Each OID is linked to a device feature or a feature aspect. The Notification Filter screen also allows network managers to filter notifications.

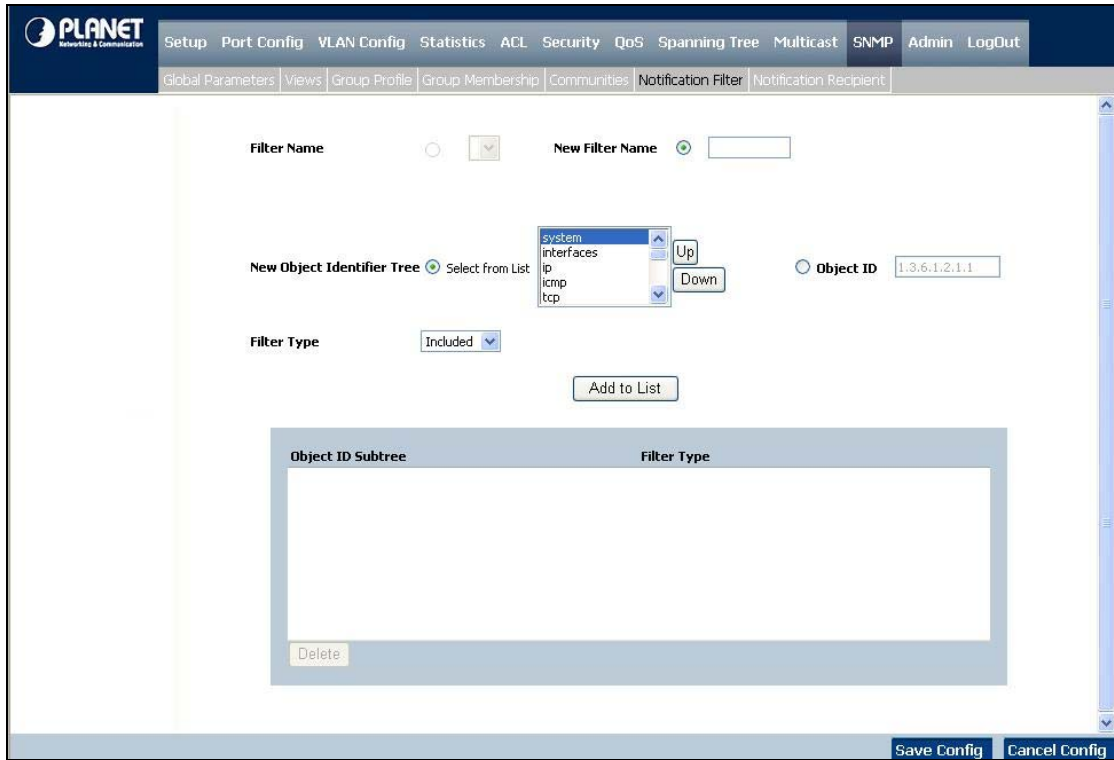
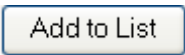

Figure 4-67 Notification Filter screen

The page contains the following fields:

| | |
|--------------------------------------|--|
| Filter Name | This contains a list of user-defined notification filters. |
| New Filter Name | Add a new user-defined notification filter name. |
| New Object Identifier Subtree | Displays the OID for which notifications are sent or blocked. If a filter is attached to an OID, traps or informs are generated and sent to the trap recipients. Object IDs are selected from either the Select from List or the Object ID List. There are two configuration options: Select from List, select the OID from the list provided. Object ID, you can enter an OID not offered in the Select from List option. |
| Filter Type | Indicates if informs or traps are sent regarding the OID to the trap recipients. |
| Excluded | Restricts sending OID traps or informs. |
| Included | Sends OID traps or informs. |

Use the  button when you want to add the Notification Filter configuration to the Notification Filter Table at the bottom of the screen.

4.11.7 Notification Recipient

The Notification Recipient screen (see figure 4-68 and 4-69) contains information for defining filters that determine whether traps are sent to specific users, and the trap type sent.

The screenshot shows the 'Notification Recipient' configuration page. The top navigation bar includes 'Setup', 'Port Config', 'VLAN Config', 'Statistics', 'ACL', 'Security', 'QoS', 'Spanning Tree', 'Multicast', 'SNMP', 'Admin', and 'LogOut'. Below this, a sub-menu shows 'Global Parameters', 'Views', 'Group Profile', 'Group Membership', 'Communities', 'Notification Filter', and 'Notification Recipient'. The main configuration area has the following fields:

- Recipient IP:** An empty text input field.
- Notification Type:** A dropdown menu with 'Traps' selected.
- Community String:** An empty text input field.
- Notification Version:** A dropdown menu with 'SNMPv1' selected.
- SNMPv1,2:** A radio button that is selected.
- SNMPv3:** A radio button that is unselected.
- User Name:** A text input field with a grey background.
- Security Level:** A dropdown menu with 'NoAuthentication' selected.
- UDP Port:** A text input field containing '162'.
- Filter Name:** A dropdown menu with a blue arrow pointing down.
- Timeout:** A text input field containing '15' followed by '(sec)'.
- Retries:** A text input field containing '3'.
- Add to List:** A button at the bottom right.

Figure 4-68 Notification Recipient

The page contains the following fields:

| | |
|--------------------------|--|
| Recipient IP | Which indicates the IP address to whom the traps are sent. |
| Notification Type | Defines the notification sent. The possible field values are: Traps, indicates traps are sent. Informs, indicates informs are sent. |
| SNMP v1.2 | Enables SNMP v1.2 as the Notification Recipient. Either SNMP v1.2 or SNMPv3 can be enabled at any one time, but not both at the same time. If String and Notification Version fields are enabled for configuration: <ul style="list-style-type: none"> • Community String, where identifies the community string of the trap manager. • Notification Version, determines the trap type. The possible field values are: <ul style="list-style-type: none"> ▪ SNMP V1, which indicates SNMP Version 1 traps are sent. ▪ SNMP V2, which indicates SNMP Version 2 traps are sent. |
| SNMP V3 | This enables SNMPv3 as the Notification Recipient. Either SNMPv1.2 or SNMP V3, enabled at any one time, but not both at the same time. If SNMP V3, which is enabled, the User Name and Security Level fields are enabled for configuration: <ul style="list-style-type: none"> • User Name - defines the user to whom SNMP notifications are sent. |
| Security Level | Defines the means by which the packet is authenticated. The possible field values are: <ul style="list-style-type: none"> • No Authentication. Indicates the packet is neither authenticated nor encrypted. |

- **Authentication**, which indicates the packet is authenticated.
- **Privacy**, which indicates the packet is both authenticated and encrypted.

UDP Port Displays the UDP port used to send notifications.
The default is **162**.

Filter Name Indicates if the SNMP filter for which the SNMP Notification filter is defined.

Timeout Indicates the amount of time (seconds) the device waits before resending informs.
The default is **15** seconds.

Retries Indicates the amount of times the device resends an inform request.
The default is 3 seconds.

Use the  button when you want to add the Notification Recipient configuration to the relevant table at the bottom of the screen.

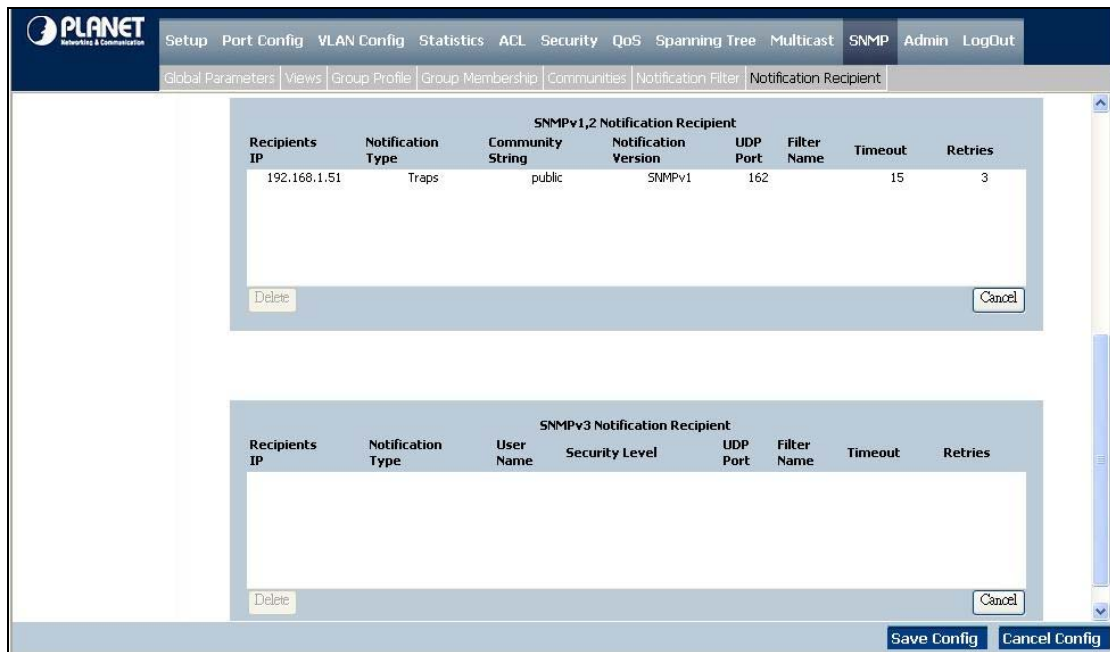

Figure 4-69 Notification Recipient

4.12 Admin

The Admin section provides information for devining system parameters including User account and file management, device software. Under Admin the folling topics are provided to devine and view the system informatin:

- User Authentication
- Static Address
- Dynamic Address
- Logging
- Port Mirroting
- Cable Test
- Storm Control
- Save Configuration
- Jumbo Frame
- Firmware Upgrade
- Reboot
- Factory Default
- Server Logs
- Memory Logs
- Flash Logs

4.12.1 User Authentication

The User Authentication screen (see figure 4-70) is used to modify user passwords.

The screenshot shows the 'User Authentication' configuration page. The 'Authentication Type' is set to 'Local'. The 'Local User Edit' section includes fields for 'User Name', 'Password', and 'Confirm Password'. The 'Password' field is marked as '(Alphanumeric)'. An 'Add to List' button is present below the 'Confirm Password' field. The 'Local Users Table' at the bottom displays a single user entry with the name 'admin'. The interface includes a top navigation bar with 'Admin' selected and a bottom bar with 'Save Config' and 'Cancel Config' buttons.

Figure 4-70 User Authentication screen

The page contains the following fields:

| | |
|----------------------------|---|
| Authentication Type | <p>Defines the user authentication methods. Also you can choose combinations of all the authentication methods. The possible field values are:</p> <ul style="list-style-type: none"> • Local, authenticates the user at the device level. The device checks the user name and password for authentication. • RADIUS, where authenticates the user at the RADIUS server. • TACACS+, which authenticates the user at the TACACS+ server. • None, assigns none authentication method to the authentication profile. |
| User Name | Displays the user name. |
| Password | Specifies the new password. The password is not displayed. As it entered an "*" corresponding to each character is displayed in the field. (Range: 1-159 characters) |
| Confirm Password | This confirms the new password. The password entered into this field must be exactly the same as the password entered in the Password field. |

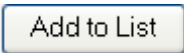
Use the  button when you want to add the user configuration to the Local User's Table.

4.12.2 Static Address

A static address can be assigned to a specific interface on this switch. Static addresses are bound to the assigned interface and cannot be moved. When a static address is seen on another interface, the address will be ignored and will not be written to the address table (see figure 4-71).

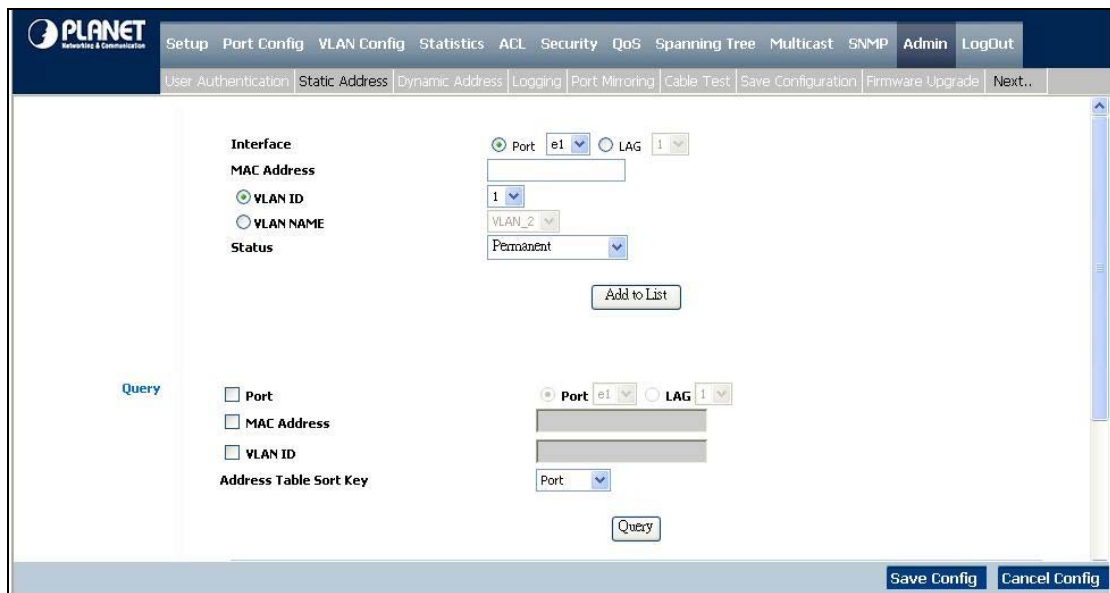

Figure 4-71 Static Address screen

The page contains the following fields:

| | |
|------------------|--|
| Interface | Displays the interface to which the entry refers: <ul style="list-style-type: none"> • Port, to which the specific port number the forwarding database parameters refer. • LAG, to which the specific LAG number the forwarding database parameters refer. MAC Address, which displays the MAC address to which the entry refers. |
| VLAN ID | Displays the VLAN ID number to which the entry refers. |
| VLAN Name | Which displays the VLAN name to which the entry refers. |
| Status | Displays how the entry was created. The possible field values are: <ul style="list-style-type: none"> • Permanent, the MAC address is permanent. • Delete on Reset, the MAC address is deleted when the device is reset. • Delete on Timeout, the MAC address is deleted when a timeout occurs. • Secure, the MAC Address is defined for locked ports. |

■ Query

| | |
|-------------------------------|---|
| Port | Specifies the interface is queried. There are two interface types from which to select. <ul style="list-style-type: none"> • Port, displays the specific port number. • LAG, the specific LAG number. |
| MAC Address | Specifies the MAC address for which the table is queried. VLAN ID, which specifies the VLAN ID for which the table is queried. |
| Address Table Sort Key | Specifies the means by which the Dynamic MAC Address Table is sorted. The address table can be sorted by - <ul style="list-style-type: none"> • VLAN • Address • Interface |

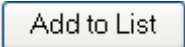
Use the  button to apply the static MAC address settings.

4.12.3 Dynamic Address

The Dynamic Address Table contains the MAC addresses learned by monitoring the source address for traffic entering the switch. When the destination address for inbound traffic is found in the database, the packets intended for that address are forwarded directly to the associated port. Otherwise, the traffic is flooded to all ports.

The Dynamic Address screen (see figure 4-72) contains parameters for querying information in the Dynamic MAC Address Table, including the interface type, MAC addresses, VLAN, and table storing. The Dynamic MAC Address table contains information about the aging time before a dynamic MAC address is erased, and includes parameters for querying and viewing the Dynamic MAC Address table. The Dynamic MAC Address table contains address parameters by which packets are directly forwarded to the ports. The Dynamic Address Table can be sorted by interface, VLAN, and MAC Address.

Figure 4-72 Dynamic Address screen

The page contains the following fields:

| | |
|----------------------|---|
| Address Aging | Specifies the amount of time (in seconds) the MAC addresses remains in the Dynamic MAC Address table before it times out, if no traffic from the source is detected. The default value is 300 seconds. |
| Clear Table | If checked, clears the MAC address table. |

■ Query

| | |
|--------------------|--|
| Port | Specifies the interface for which the table is queried. There are two interface types from which to select: <ul style="list-style-type: none"> • Port - displays the specific port number. • LAG - displays the specific LAG number. |
| MAC Address | Specifies the MAC address for which the table is queried. |

| | |
|-------------------------------|---|
| VLAN ID | Specifies the VLAN ID for which the table is queried. |
| Address Table Sort Key | Specifies the means by which the Dynamic MAC Address table is sorted by address, VLAN, or interface. |

4.12.4 Logging

The System Logs enable viewing device events in real time, and recording the events for later usage. System Logs record and manage events and report errors or informational messages (see figure 4-73).

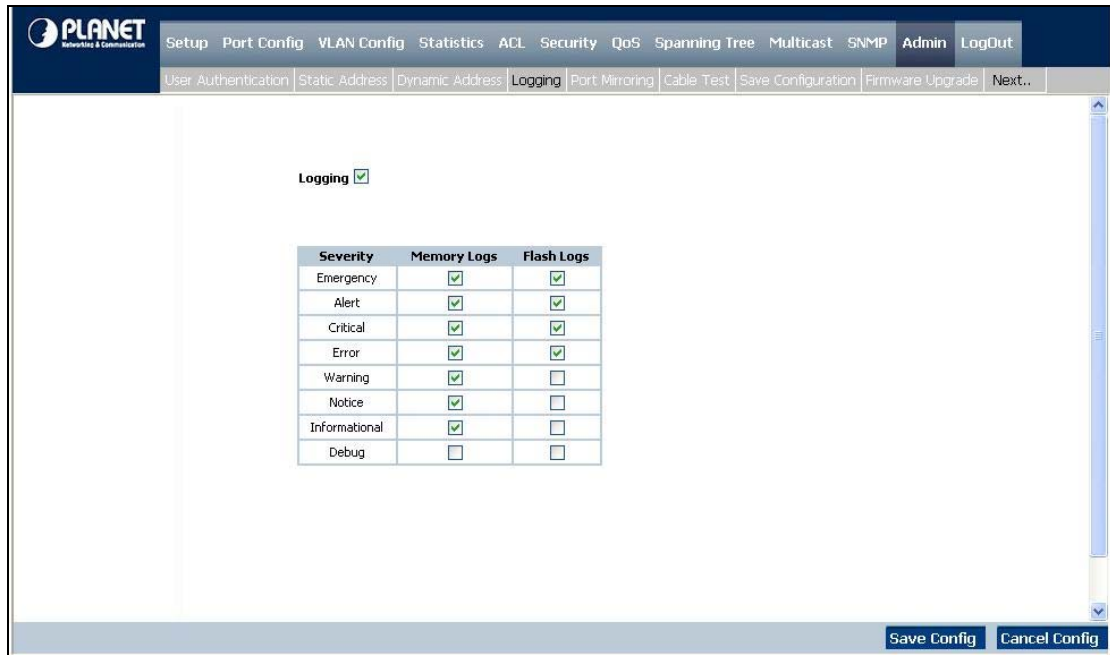

Figure 4-73 Login screen

Event messages have a unique format, as per the SYSLOG protocols recommended message format for all error reporting. For example, System logs and local device reporting messages are assigned a severity code, and include a message mnemonic, which identifies the source application generating the message. It allows messages to be filtered based on their urgency or relevancy. Each message severity determines the set of event logging devices that are sent per each event logging.

The page contains the following fields:

| | |
|------------------|---|
| Logging | Indicates if device global logs for Cache, File, and Server Logs are enabled. Console logs are enabled by default. |
| Emergency | The system is not functioning. |
| Alert | The system needs immediate attention. |
| Critical | The system is in a critical state. |
| Error | A system error has occurred. |

| | |
|----------------------|--|
| Warning | A system warning has occurred. |
| Notice | The system is functioning properly, but system notice has occurred. |
| Informational | Provides device information. |
| Debug | Provides detailed information about the log. If a Debug error occurs, contact Customer Tech Support. |

4.12.5 Port Mirroring

Port mirroring monitors and mirrors network traffic by forwarding copies of incoming and outgoing packets from one port to a monitoring port. Port mirroring can be used as diagnostic tool and/or a debugging feature. Port mirroring also enables switch performance monitoring (refer to figure 4-74).

Network administrators configure port mirroring by selecting a specific port to copy all packets, and different ports from which the packets are copied.

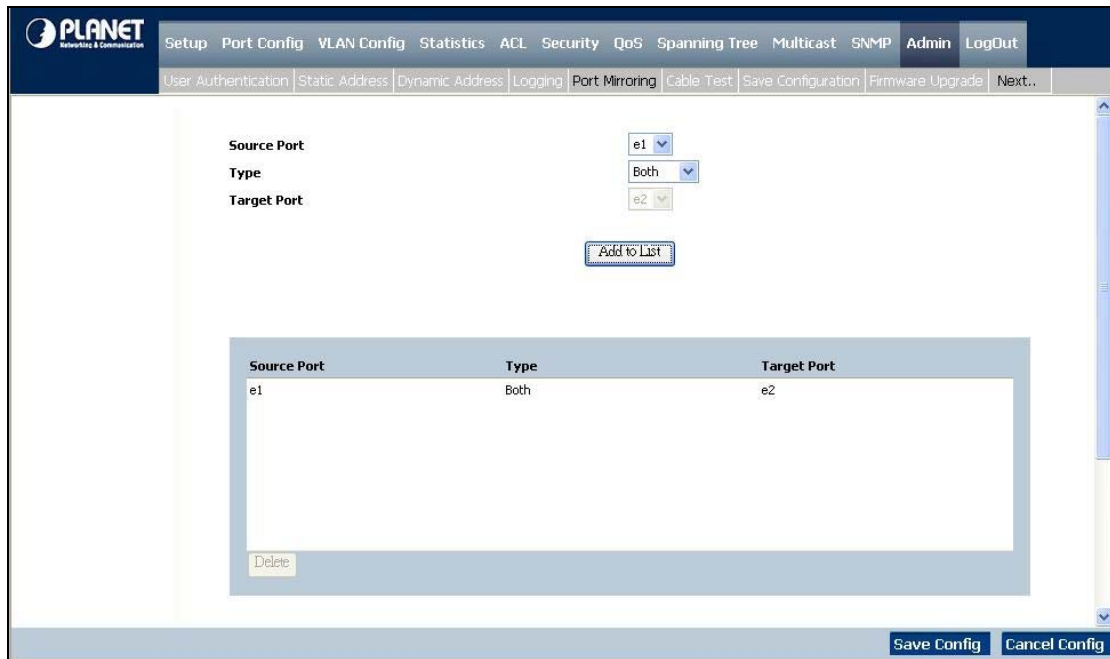

Figure 4-74 Port Mirroring screen

The page contains the following fields:

| | |
|--------------------|--|
| Source Port | Defines the port to which traffic is mirrored. |
| Type | Indicates the port mode configuration for port mirroring. The possible field values are: <ul style="list-style-type: none"> • RxOnly, defines the port mirroring on receiving ports. This is the default value. • TxOnly, defines the port mirroring on transmitting ports. • Both, which defines the port mirroring on both receiving and transmitting ports. |
| | Target Port, defines the port from which traffic is mirrored. |

4.12.6 Cable Test

The Cable Test screen (see figure 4-75) shows you results from performance tests on copper cables. The maximum cable length that can be tested is 120 meters. Cables are tested when the ports are in the down state, except for the Approximate Cable Length test.

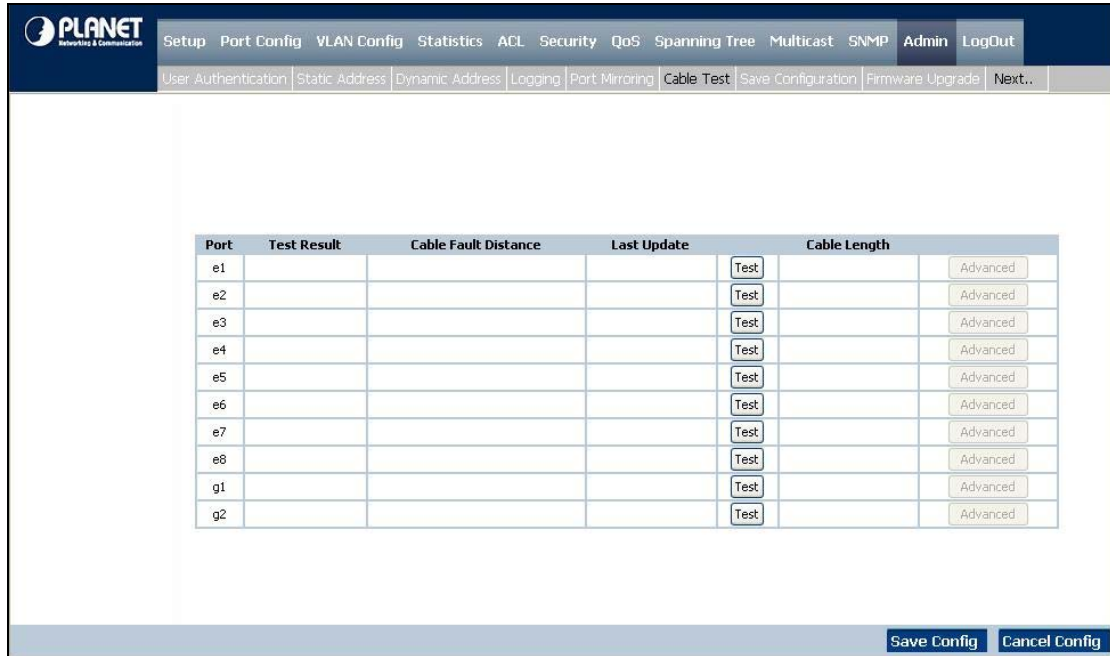

Figure 4-75 Cable Test screen

The page contains the following fields:

-
- Port** This is the port to which the cable is connected.

 - Test Result**
 - **OK** - indicates that the cable passed the test.
 - **No Cable** - means no cable connected to the port.
 - **Open Cable** -means the cable is connected on only one side.
 - **Short Cable** - indicates that a short has occurred in the cable.

 - Cable Fault Distance** This is the distance from the port at which the cable error occurred.

 - Last Update** This is the last time the port was tested.

 - Cable Length** This is the approximate length of the cable.
 The Cable Length test can be performed only when the port is up and operating at 1Gbps.
-

4.12.7 Save Configuration

On this screen, you can choose two methods to save the configuration: Via TFTP Upgrade and Via HTTP. See figure 4-76



Figure 4-76 Save Configuration via TFTP

The page contains the following fields:

■ **Via TFTP**

| | |
|-------------------------|--|
| Via TFTP Upgrade | Select this option to upgrade the switch from a file located on a TFTP Server. |
| TFTP Server | The TFTP Server IP Address that contains the source files to upgrade from. |
| Source File | Specifies the name of the upgrade file on the TFTP Server. |
| Destination File | Where specifies the name of the configuration file. The default is StartupCfg. |

■ **Via HTTP**

This HTTP Firmware Upgrade screen is used for saving configuration information using your Web browser. See figure 4-77

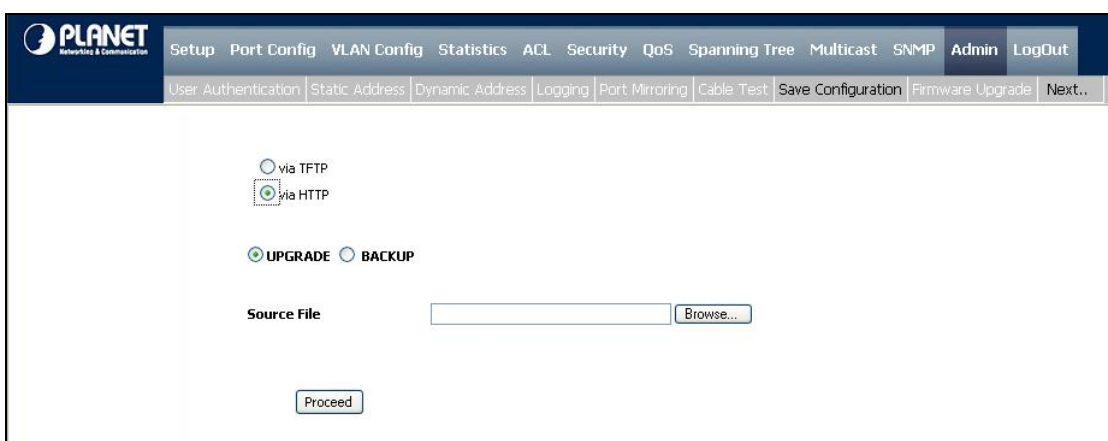

Figure 4-77 Save Configuration via HTTP

| | |
|----------------|---|
| Upgrade | Select this option to upgrade the switch from a file on the local hard drive. |
|----------------|---|

Backup This is used to backup the configuration to the local hard drive.

Source File Type in the name and path of the file or Browse to locate the upgrade file.

Use the **Proceed** button to save configuration via TFTP or HHTP that be selected.

4.12.8 Jumbo Frame

On this screen, you can choose the jumbo frame function “disable” or “enable”. See figure 4-78

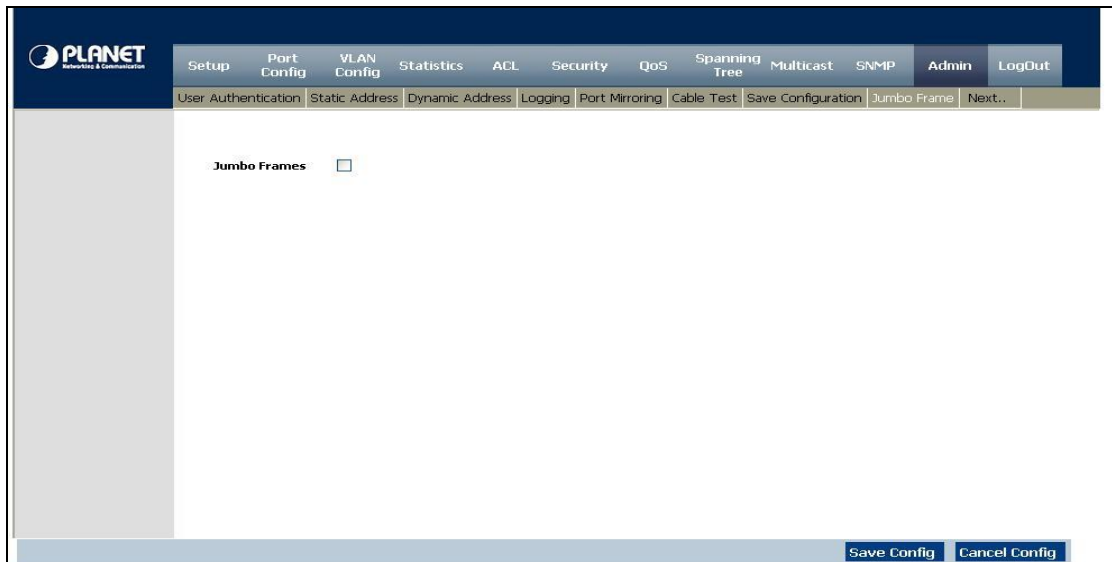

Figure 4-78 Jumbo Frames screen

4.12.9 Firmware Upgrade

The Firmware Upgrade screen contains the following fields:

See figure 4-79

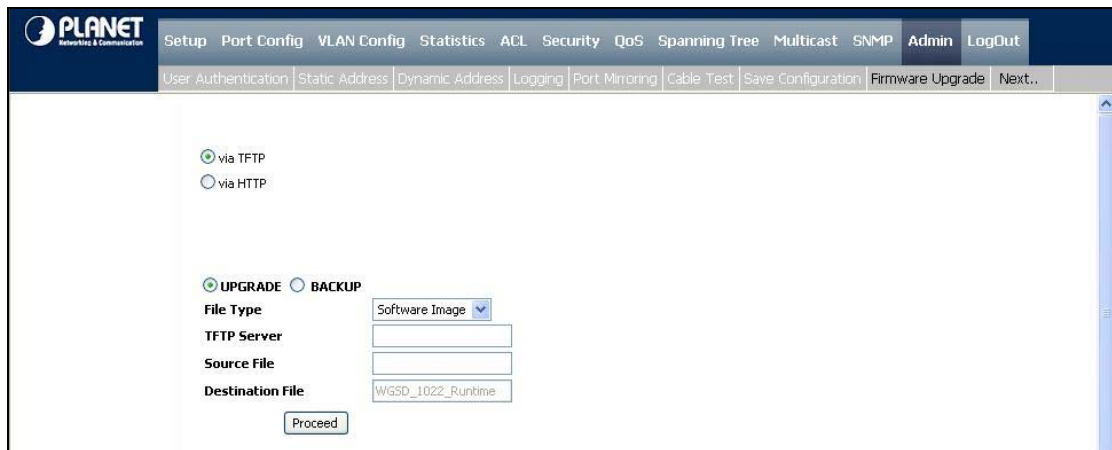

Figure 4-79 Firmware Upgrade via TFTP

The page contains the following fields:

■ **Via TFTP**

| | |
|-------------------------|--|
| Via TFTP | Defines the upgrade through a TFTP Server. |
| File Type | Select file type to be upgraded through a TFTP Server. The possible field values are : <ul style="list-style-type: none"> • Software Image. • Boot Code. |
| TFTP Server | The TFTP Server IP Address that contains the source file to upgrade from. |
| Source File | Specifies the name of the upgrade file on the TFTP Server. |
| Destination File | Type in the name and path of the file or Browse to locate the upgrade file. |

■ **Via HTTP**

See figure 4-80



Figure 4-80 Firmware Upgrade via HTTP

| | |
|-------------------------|--|
| Via HTTP | Allows you to upgrade the firmware using your Web browser. |
| Source File Name | Specifies the file to be downloaded. |

Use the **Proceed** button to upgrade the firmware via TFTP or HHTP that be selected.

4.12.10 Reboot

The Reboot screen (see figure 4-81) resets the device whose configuration is automatically saved before the device is rebooted.

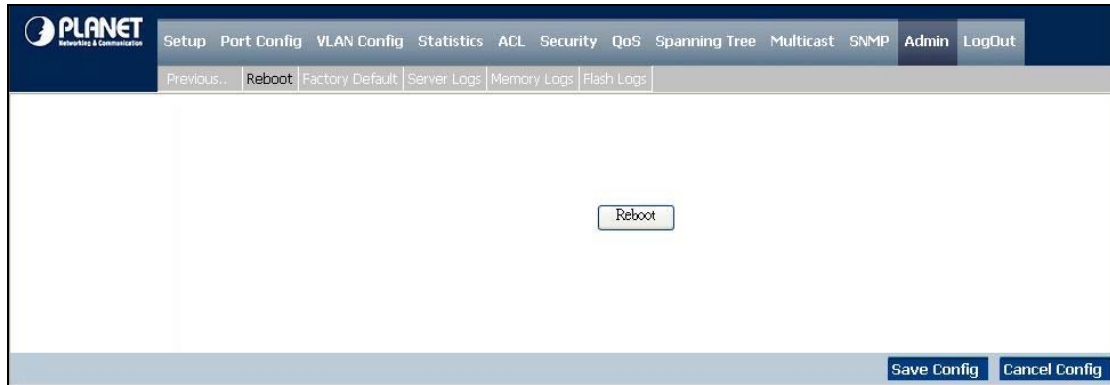

Figure 4-81 Reboot screen

Notice: There is a known issue. Sometimes after the “Reboot” button be pressed, it costs lot time to stop the curent tasks. So it might be rebooted after more then 5 minutes.

4.12.11 Factory Defaults

The Factory Reset screen (see figure 4-82) allows network managers to reset the device to the factory defaults settings, but if you restore factory defaults results in erasing the configuration file. Although restoring the factory defaults will erase your configuration, you can save a backup of your current configuration settings from the Admin - Save Configuration screen.

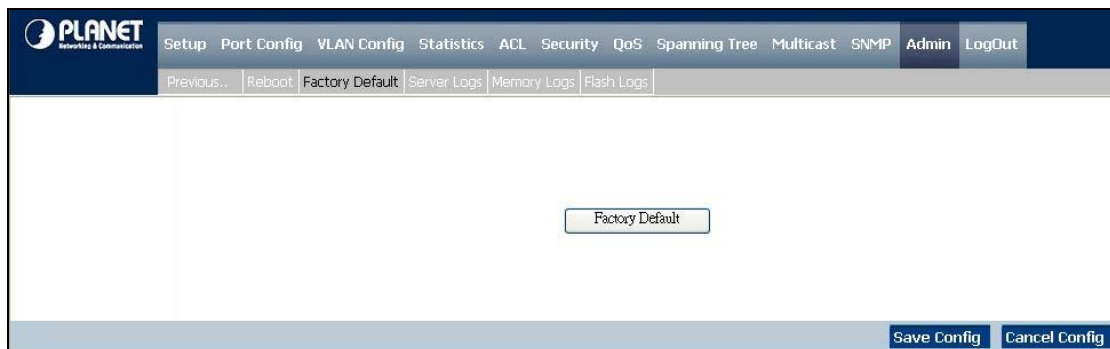

Figure 4-82 Factory Default screen

4.12.12 Server Logs

The Global Log Parameters page contains fields for enabling logs globally, and fields for defining log parameters. The Severity log messages are listed from the highest severity to the lowest.

Event messages have a unique format, as per the SYSLOG RFC recommended message format for all error reporting. For example, Syslog+ local device reporting. Messages are assigned a severity code, and include a message mnemonic, which identifies the source application generating the message. Messages are filtered based on their urgency or relevancy. The severity of each message determines the set of event logging devices to which are sent for each event logging device. The following table contains the Log Severity Levels:

| Severity Type | Severity Level | Description | Example |
|---------------|----------------|---|-----------------------------------|
| Emergency | 0 | The system is not functioning. | Memories overflow. |
| Alert | 1 | The system needs immediate attention. | Main system memory pool overflow. |
| Critical | 2 | The system is in a critical state. | Cannot bind to SNMP. |
| Error | 3 | A system error has occurred. | Failed to delete entry. |
| Warning | 4 | A system warning has occurred. | Port down. |
| Notice | 5 | The system is functioning properly, but system notice has occurred. | Bad route. |
| Informational | 6 | Provides device information. | Link up. |
| Debug | 7 | Provides detailed information about the log. If a Debug error occurs, contact Dell Online Technical Support | Method list created. |

The Server Logs screen (see figure 4-83) contains information for viewing and configuring the Remote Log Servers. New log servers can be defined, and the log severity sent to each server.

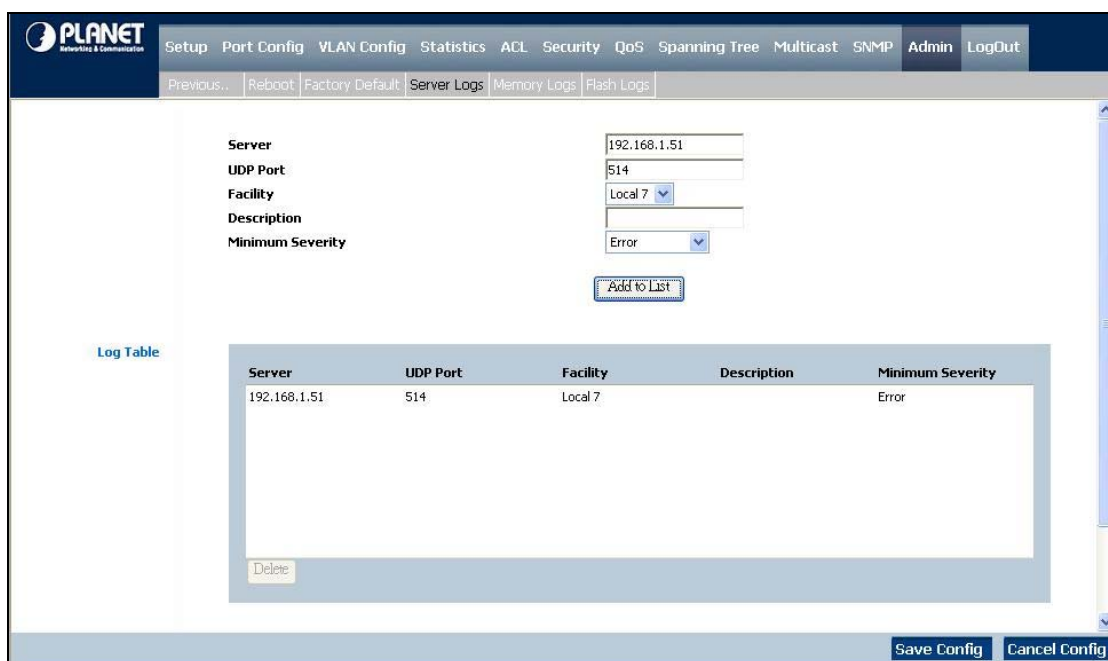



Figure 4-83 Server Logs screen

There are five items, as below:

| | |
|---------------------------|---|
| Server | Specifies the server to which logs can be sent. |
| UDP Port (1-65535) | Defines the UDP port to which the server logs are sent. The possible range is 1 to 65535. The default value is 514 . |
| Facility | Defines a user-defined application from which system logs are sent to the remote server. Only one facility can be assigned to a single server. If a second facility level is assigned, the first facility is overridden. All applications defined for a device utilize the same facility on a server. The possible field values are Local 0 - Local 7. The field default is Local 7 . |
| Description | Where provides a user-defined server description. |
| Minimum Severity | Indicates the Minimum severity from which logs are sent to the server. For example, if Notice is selected, all logs from a Notice severity and higher are sent to the remote server. |

If you want to add the Server Log configuration to the Server Log Table, use the **Add to List** button at the bottom of the screen.

 **Notice:** When a severity level is selected, all severity level choices above the selection are selected automatically.

4.12.13 Memory Logs

The Memory Log screen (see figure 4-84) contains all system logs in a chronological order that are saved in RAM (Cache), Log Index which shows the log number, Log Time at which the log was generated, Severity which shows the log severity, and the description that shows log message text.

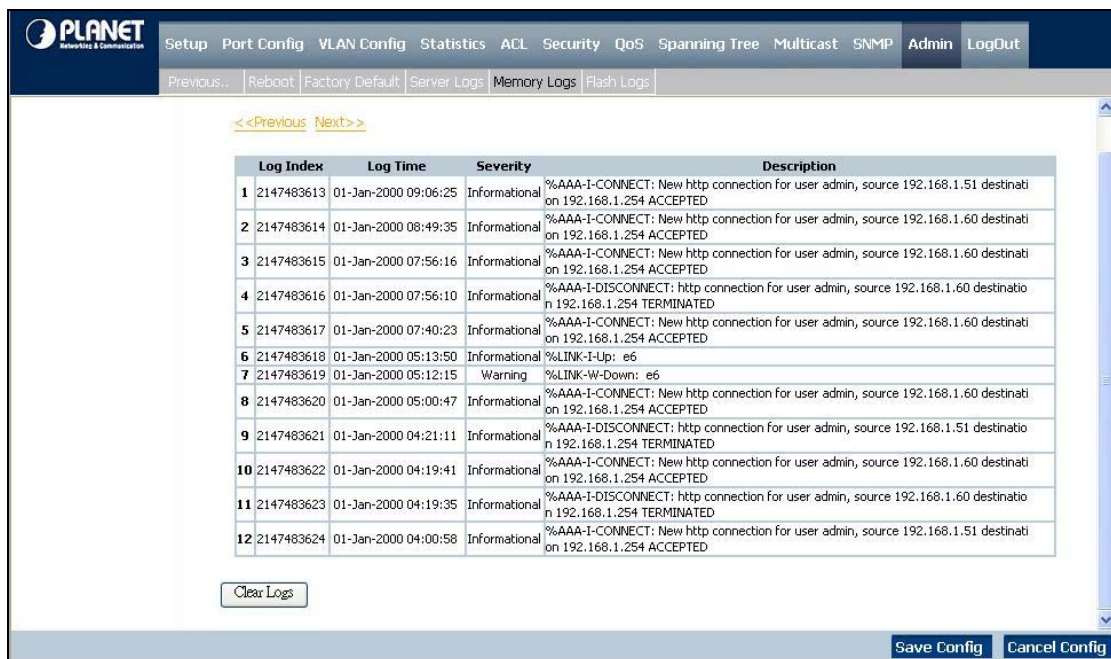

Figure 4-84 Memory Logs screen

The page contains the following fields:

| | |
|--------------------|--|
| Log Index | The log number in the Log File Table. |
| Log Time | Specifies the time at which the log was entered in the Log File Table. |
| Severity | Specifies the log severity. |
| Description | The log message text. |

4.12.14 Flash Logs

The Flash Log screen (see figure 4-85) contains information about log entries saved to the Log File in FLASH, the time that the log generated, the log severity, and description of the log message. The Message Log is available after reboot.

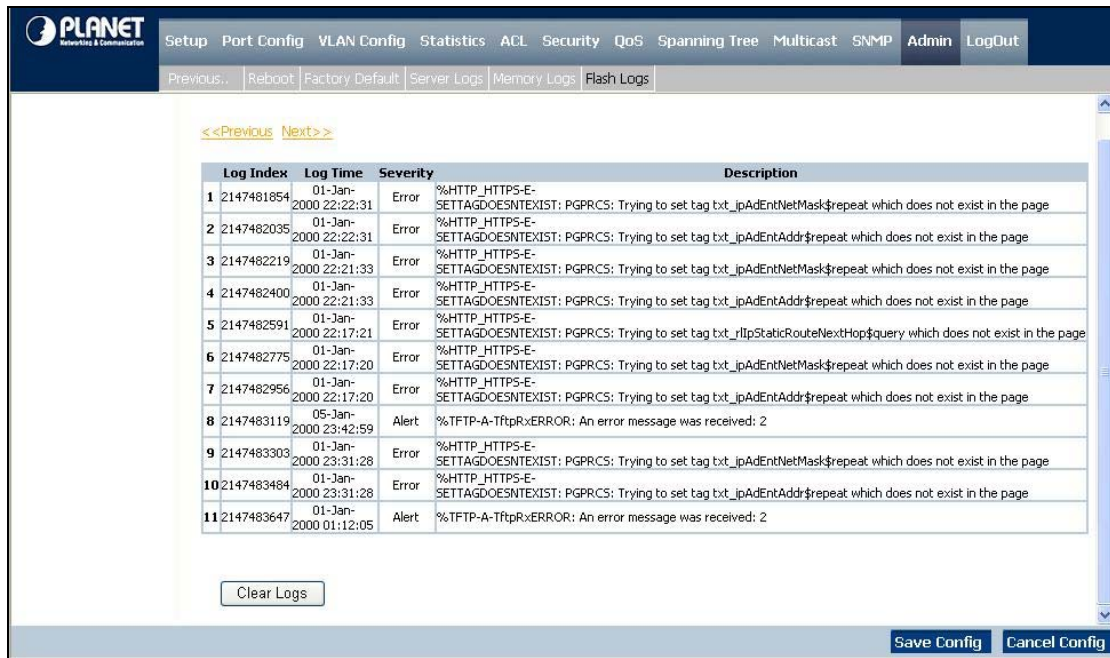

Figure 4-85 Flash Logs screen

5. COMMAND STRUCTURE

The WGSW-24020/WGSW-48040 is a managed Ethernet Switch that can be controlled by the RS-232 console interface, telnet interface, and Web interface. This chapter describes how to configure the Switch through these interfaces.

When you are ready to configure the smart functions of the Switch, make sure you had connected the supplied RS-232 serial cable to the RS-232 port at the front panel of your WGSW-24010 Switch and your PC.

5.1 Connect to PC's RS-232 serial port

Hyper Terminal

In Windows 98/2000/XP, launch "HyperTerminal", create a new connection, and adjust settings as below:

- Baud per second: **38400**
- Data bits: **8**
- Parity: **None**
- Stop bits: **1**
- Flow Control: **None**

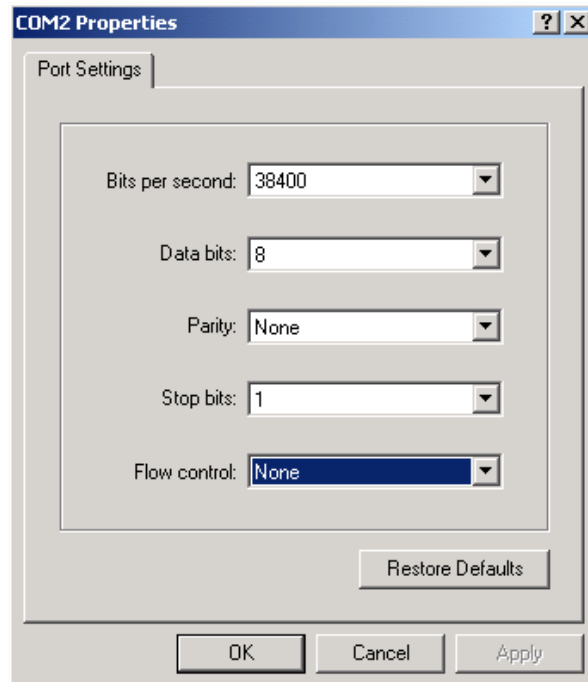

5.2 Using the CLI

5.2.1 CLI Command Modes

The Command Line Interface (CLI) syntax, conventions and terminology are described in this section. Each CLI command is illustrated using the structure outlined below.

Introduction

To assist in configuring devices, the CLI command-line interface is divided into different command modes. Each command mode has its own set of specific commands. Entering a question mark "?" at the system prompt (console prompt) displays a list of commands available for that particular command mode.

From each mode a specific command is used to navigate from one command mode to another. The standard order to access the modes is as follows: User EXEC mode, Privileged EXEC mode, Global Configuration mode, and Interface Configuration mode. The following figure illustrates the command mode access path.

When starting a session, the initial mode is the User EXEC mode. Only a limited subset of commands is available in User EXEC Mode. This level is reserved for tasks that do not change the configuration. To enter the next level, the Privileged EXEC mode, a password is required.

The Privileged mode gives access to commands that are restricted on EXEC mode and provides access to the device Configuration mode.

The Global Configuration mode manages the device configuration on a global level. For specific interface configurations enter the next level, the Interface Configuration Mode.

The Interface Configuration mode configures specific interfaces in the device.

User EXEC Mode

After logging into the device, the user is automatically in user EXEC command mode unless the user is defined as a privileged user. In general, the user EXEC commands allow the user to perform basic tests, and list system information.

The user-level prompt consists of the device "host name" followed by the angle bracket (>).

```
console >
```

The default host name is "Console" unless it has been changed using the **hostname** command in the Global Configuration mode.

Privileged EXEC Mode

Because many of the privileged commands set operating parameters, privileged access is password protected to prevent unauthorized use. The password is not displayed on the screen and is case sensitive.

Privileged users are entered directly into the Privileged EXEC mode. To enter the Privileged EXEC mode commands from the User EXEC mode perform the following: At the prompt enter the command enable and press <Enter>. A password prompt is displayed. Enter the password and press <Enter>. The password is displayed as "*". The privileged EXEC mode prompt is displayed. The Privileged EXEC mode prompt consists of the device "host name" followed by "#".

```
console #
```

To return from Privileged mode to User EXEC mode, use the following **disable** commands.

The following example illustrates how to access Privileged mode and return back to the User EXEC mode:

```
console > enable
enter Password: * * * * *
console #
console # disable
console >
```

Exit is used to move back from any mode to a previous level mode, except from Privileged EXEC to User EXEC mode, for example from Interface Configuration mode to Global Configuration mode, and from Global Configuration mode to Privileged EXEC mode.

Global Configuration Mode

Global configuration commands apply to features that affect the system as a whole, rather than just a specific interface. The Privileged EXEC mode command **configure** is used to enter the Global Configuration mode.

The Global Configuration mode commands perform the following:

At the Privileged EXEC mode prompt enter the command **configure** and press **<Enter>**. The Global Configuration mode prompt is displayed. The Global Configuration mode prompt consists of the device "host name" followed by the word "(config)" and "#".

```
console #
```

To return from Global Configuration mode to Privileged EXEC mode, the user can use one of the following commands:

- **exit**
- **end**
- **Ctrl+Z**

The following example illustrates how to access Global Configuration mode and return back to the Privileged EXEC mode:

```
console #
console # configure
console(config) # exit
console #
```

Interface Configuration Mode and Specific Configuration Modes

Interface Configuration commands are to modify specific interface operations. The following are the Interface Configuration modes:

- **Line Interface**—Contains commands to configure the management connections. These include commands such as line speed, timeout settings, etc. The Global Configuration mode command **line** is used to enter the line configuration command mode.
- **VLAN Database**—Contains commands to create a VLAN as a whole. The Global Configuration mode command **vlan database** is used to enter the VLAN Database Interface Configuration mode.
- **Management Access List**—Contains commands to define management access-lists. The Global Configuration mode command **management access-list** is used to enter the Management Access List Configuration mode.
- **Ethernet**—Contains commands to manage port configuration. The Global Configuration mode command **interface ethernet** enters the Interface Configuration mode to configure an Ethernet type interface.
- **Port Channel**—Contains commands to configure port-channels, for example, assigning ports to a VLAN or port-channel. Most of these commands are the same as the commands in the Ethernet interface mode, and are used to manage the member ports as a single entity. The Global Configuration mode command **interface port-channel** is used to enter the port-channel Interface Configuration mode.
- **SSH Public Key-chain**—Contains commands to manually specify other device SSH public keys. The Global Configuration mode command **crypto key pubkey-chain ssh** is used to enter the SSH Public Key-chain Configuration mode.
- **MAC Access-List**—Configures conditions required to allow traffic based on MAC addresses. The Global Configuration mode command **mac-access list** is used to enter the MAC access-list configuration mode.
- **Interface**—Contains commands that configure the interface. The Global Configuration mode command **interface ethernet** is used to enter the interface configuration mode.

5.2.2 Starting the CLI

The switch can be managed over a direct connection to the switch console port, or via a Telnet connection. The switch can also be managed via an out-of-band (OOB) management port. The switch is managed by entering command keywords and parameters at the prompt. Using the switch command-line interface (CLI) is very similar to entering commands on a UNIX system.

If access is via a Telnet connection, ensure that the device has an IP address defined, that corresponding management access is granted, and that the workstation used to access the device is connected to the device prior to beginning using CLI commands.

 **Notice:** The following steps are for use on the console line only.

To begin running CLI, perform the following:

1. Start the device and wait until the startup procedure is complete.
2. The User Exec mode is entered into, and the prompt "console>" is displayed.

3. Configure the device and enter the necessary commands to complete the required tasks.
4. When finished, exit the session with the **quit** or **exit** command.

When a different user is required to log onto the system, in the Privileged EXEC Command mode the **login** command is entered. This effectively logs off the current user and logs on the new user.

5.2.3 Editing Features

Entering Commands

A CLI command is a series of keywords and arguments. Keywords identify a command, and arguments specify configuration parameters. For example, in the command "**show interfaces status ethernet e5**," **show**, **interfaces** and **status** are keywords, **ethernet** is an argument that specifies the interface type, and **e5** specifies the port.

When entering commands, the Giga ports are referred to with a prefix "g", and the 10/100 Mbps ports are referred to with a prefix "e". The ports are preceded by the unit number. The unit number for a standalone device is 1.

To enter commands that require parameters, enter the required parameters after the command keyword. For example, to set a password for the administrator, enter:

```
console(config)# username admin password smith
```

When working with the CLI, the command options are not displayed. The command is not selected by a menu but is manually entered. To see what commands are available in each mode or within an interface configuration, the CLI does provide a method of displaying the available commands, the command syntax requirements and in some instances parameters required to complete the command. The standard command to request help is the **?**.

There are three instances where the help information can be displayed:

- **Keyword lookup**—The character **?** is entered in place of a command. A list of all valid commands and corresponding help messages are displayed.
- **Partial keyword lookup**—A command is incomplete and the character **?** is entered in place of a parameter. The matched parameters for this command are displayed.
- To assist in using the CLI, there is an assortment of editing features. The following features are described:
 - Terminal Command Buffer
 - Command Completion
 - Keyboard Shortcuts

Every time a command is entered in the CLI, it is recorded on an internally managed Command History buffer. Commands are stored in the buffer which is maintained on a *First In First Out (FIFO)* basis. These commands can be recalled, reviewed, modified, and reissued. This buffer is not preserved across device resets.

| Keyword | Source or destination |
|----------------|---|
| Up-arrow key | Recalls commands in the history buffer, beginning with the most recent command. |
| Ctrl+P | Repeats the key sequence to recall successively older commands. |
| Down-arrow key | Returns to more recent commands in the history buffer after recalling commands with the up-arrow key. Repeating the key sequence will recall successively more recent commands. |

By default, the history buffer system is enabled, but it can be disabled at any time. For information about the command syntax to enable or disable the history buffer, see `history`.

There is a standard default number of commands that are stored in the buffer. The standard number of 10 commands can be increased to 256. By configuring 0, the effect is the same as disabling the history buffer system. For information about the command syntax for configuring the command history buffer, see `history size`.

To display the history buffer, see `show history`.

Negating the Effect of Commands

For many configuration commands, the prefix keyword **no** can be entered to cancel the effect of a command or reset the configuration to the default value. This guide describes the negation effect for all applicable commands.

Command Completion

If a command is entered and it is not complete, if the command is invalid, or if some parameters of the command are invalid or missing, the appropriate error message is displayed. This assists in entering the correct command. By pressing the <Tab> button, an incomplete command is entered. If the characters already entered are not enough for the system to identify a single matching command, press "?" to display the available commands matching the characters already entered.

Incorrect or incomplete commands are automatically re-entered next to the cursor. If a parameter must be added, the parameter can be added to the basic command already displayed next to the cursor. The following example indicated that the command **interface ethernet** requires the parameter **<port-num>**.

```
(config) # interface ethernet
%missing mandatory parameter
(config) # interface ethernet e5
```

Keyboard Shortcuts

The CLI has a range of keyboard shortcuts to assist in editing the CLI commands. The following table describes the CLI shortcuts.

| Keyboard | Key Description |
|----------------|---|
| Up-arrow key | Recalls commands in the history buffer, beginning with the most recent command. Repeat the key sequence to recall successively older commands. |
| Down-arrow key | Returns to more recent commands in the history buffer after recalling commands with the up arrow key. Repeating the key sequence will recall successively more recent commands. |
| Ctrl+A | Moves the cursor to the beginning of the command line. |
| Ctrl+E | Moves the cursor to the end of the command line. |
| Ctrl+Z / End | Returns back to the Privileged EXEC mode from all modes. |
| Backspace key | Moves the cursor back one space. |

CLI Command Conventions

When entering commands there are certain command entry standards which apply to all commands. The following table describes the command conventions.

| Convention | Description |
|--------------------|--|
| [] | In a command line, square brackets indicate an optional entry. |
| { } | In a command line, curly brackets indicate a selection of compulsory parameters separated by the character. One option must be selected. For example: flowcontrol {auto on off} means that for the flowcontrol command either auto , on or off must be selected. |
| <i>Italic font</i> | Indicates a parameter. |
| <Enter> | Any individual key on the keyboard. For example click <Enter>. |
| Ctrl+F4 | Any combination keys pressed simultaneously on the keyboard. |
| Screen | Indicates system messages and prompts appearing on the console. |

| | |
|---------|---|
| Display | |
| all | When a parameter is required to define a range of ports or parameters and all is an option, the default for the command is all when no parameters are defined. For example, the command interface range port-channel has the option of either entering a range of channels, or selecting all . When the command is entered without a parameter, it automatically defaults to all . |

5.3 AAA Commands

5.3.1 aaa authentication login

The **aaa authentication login** global configuration command defines login authentication. To return to the default configuration, use the **no** form of this command.

Syntax

aaa authentication login {**default** | *list-name*} *method1* [*method2...*]

no aaa authentication login {**default** | *list-name*}

- **Default** — Uses the listed authentication methods that follow this argument as the default list of methods when a user logs in.
- *list-name*—Character string used to name the list of authentication methods activated when a user logs in.
- *method1* [*method2...*]—Specify at least one from the following table:

| Keyword | Source or destination |
|---------|---|
| enable | Uses the enable password for authentication. |
| line | Uses the line password for authentication. |
| local | Uses the local username database for authentication |
| none | Uses no authentication. |
| radius | Uses the list of all RADIUS servers for authentication. Uses username |
| tacacs | Uses the list of all TACACS servers for authentication. Uses username |

Default Configuration

The local user database is checked. This has the same effect as the command **aaa authentication login listname local**.

 **Notice:** On the console, login succeeds without any authentication check if the authentication method is not defined.

Command Mode

Global Configuration mode

User Guidelines

The default and optional list names created with the **aaa authentication login** command are used with the **login authentication** command.

Create a list by entering the **aaa authentication login list-name method** command for a particular protocol, where *list-name* is any character string used to name this list. The *method* argument identifies the list of methods that the authentication algorithm tries, in the given sequence.

The additional methods of authentication are used only if the previous method returns an error, not if it fails. To ensure that the authentication succeeds even if all methods return an error, specify **none** as the final method in the command line.

Example

The following example configures authentication login.

```
console (config) # aaa authentication login default radius local enable none
```

5.3.2 aaa authentication enable

The **aaa authentication enable** global configuration command defines authentication method lists for accessing higher privilege levels. To return to the default configuration use the **no** form of this command.

Syntax

aaa authentication enable {**default** | *list-name*} *method1* [*method2...*]

no aaa authentication enable default

- **default** — Uses the listed authentication methods that follow this argument as the default list of methods, when using higher privilege levels.
- *list-name* — Character string used to name the list of authentication methods activated, when using access higher privilege levels.
- *method1* [*method2...*]—Specify at least one from the following table:

| Keyword | Source or destination |
|---------|---|
| Enable | Uses the enable password for authentication. |
| Line | Uses the line password for authentication |
| None | Uses no authentication |
| Radius | Uses the list of all radius servers for authentication. Uses username "\$enabx\$." Where x is the privilege level |
| Tacacs | Uses the list of all TACACS+ servers for authentication. Uses username "\$enabx\$." Where x is the privilege level. |

Default Configuration

If the **default** list is not set, only the enable password is checked. This has the same effect as the command **aaa authentication enable default enable**.

On the console, the enable password is used if it exists. If no password is set, the process still succeeds. This has the same effect as using the command **aaa authentication enable default enable none**.

Command Mode

Global Configuration mode

User Guidelines

The default and optional list names created with the **aaa authentication enable** command are used with the **enable authentication** command.

Create a list by entering the **aaa authentication enable *list-name* *method*** command where *list-name* is any character string used to name this list. The *method* argument identifies the list of methods that the authentication algorithm tries, in the given sequence.

The additional methods of authentication are used only if the previous method returns an error, not if it fails. To ensure that the authentication succeeds even if all methods return an error, specify **none** as the final method in the command line.

All **aaa authentication enable default** requests sent by the router to a RADIUS server include the username "\$enabx\$", where x is the requested privilege level.

Example

The following example sets authentication when accessing higher privilege levels.

```
console (config) # aaa authentication enable default enable
```

5.3.3 login authentication

The login authentication line configuration command specifies the login authentication method list for a remote telnet or console. To return to the default specified by the authentication login command, use the **no** form of this command.

Syntax

login authentication {**default** | *list-name*}

no login authentication

- **default** — Uses the default list created with the **authentication login** command.
- *list-name* — Uses the indicated list created with the **authentication login** command.

Default Configuration

Uses the default set with the command **authentication login**.

Command Mode

Line Configuration mode

User Guidelines

Changing login authentication from default to another value may disconnect the telnet session.

Example

The following example specifies the default authentication method for a remote Telnet or console.

```
console (config) # line cnsol
console (config-line) # login authentication default
```

5.3.4 enable authentication

The **enable authentication** line configuration command specifies the authentication method list when accessing a higher privilege level from a remote telnet or console. To return to the default specified by the **enable authentication** command, use the **no** form of this command.

Syntax

enable authentication {**default** | *list-name*}

no enable authentication

- **default** — Uses the default list created with the **authentication enable** command.
- *list-name* — Uses the indicated list created with the **authentication enable** command.

Default Configuration

Uses the default set with the command **authentication enable**.

Command Mode

Line Configuration mode

User Guidelines

There are no user guidelines for this command.

Example

The following example specifies the default authentication method when accessing a higher privilege level from a remote Telnet or console.

```
console (config) # line cnsol
console (config-line) # enable authentication default
```

5.3.5 ip http authentication

The **ip http authentication** global configuration mode command specifies authentication methods for http. To return to the default, use the **no** form of this command.

Syntax

ip http authentication *method1* [*method2...*]

no ip http authentication

- *method1* [*method2...*] — Specify at least one from the following table

| Keyword | Source or destination |
|---------|--|
| local | Uses the local username database for authentication |
| none | Uses no authentication |
| radius | Uses the list of all RADIUS servers for authentication |
| tacacs | Uses the list of all TACACS servers for authentication |

Default Configuration

The local user database is checked. This has the same effect as the command **ip http authentication local**.

Command Mode

Global Configuration mode

User Guidelines

The additional methods of authentication are used only if the previous method returns an error, not if it fails. To ensure that the authentication succeeds even if all methods return an error, specify **none** as the final method in the command line.

Example

The following example configures the http authentication.

```
console (config) # ip http authentication radius local
```

5.3.6 ip https authentication

The **ip https authentication** global configuration command specifies authentication methods for https servers. To return to the default, use the **no** form of this command.

Syntax

ip https authentication *method1* [*method2...*]

no ip https authentication

- *method1* [*method2...*] — Specify at least one from the following table:

| Keyword | Source or destination |
|---------|--|
| local | Uses the local username database for authentication |
| none | Uses no authentication |
| radius | Uses the list of all RADIUS servers for authentication |
| tacacs | Uses the list of all TACACS servers for authentication |

Default Configuration

The local user database is checked. This has the same effect as the command **ip https authentication local**.

Command Mode

Global Configuration mode

User Guidelines

The additional methods of authentication are used only if the previous method returns an error, not if it fails. To ensure that the authentication succeeds even if all methods return an error, specify **none** as the final method in the command line.

Example

The following example configures https authentication.

```
console (config) # ip https authentication radius local
```

5.3.7 show authentication methods

The **authentication methods** privilege EXEC command displays information about the authentication methods.

Syntax

show authentication methods

Default Configuration

This command has no default configuration.

Command Mode

Privileged EXEC mode

User Guidelines

There are no user guidelines for this command.

Example

The following example displays the authentication configuration.

```

console# show authentication methods

Login Authentication Method Lists
-----
Default: Radius, Local, Line
Console_Login: Line, None

Enable Authentication Method Lists
-----
Default: Radius, Enable
Console_Enable: Enable, None

Line           Login Method List           Enable Method List
-----
Console        Console_Login                Console_Enable
Telnet         Default                      Default
SSH            Default                      Default

HTTP: Radius, local
HTTPS: Radius, local
802.1x: Radius

```

5.3.8 password

The **password** line configuration command specifies a password on a line. To remove the password, use the **no** form of this command.

Syntax

password *password* [**encrypted**]

no password

- *password* — Password for this level, from 1 to 159 characters in length.
- **encrypted** — Encrypted password to be entered, copied from another device configuration.

Default Configuration

This command has no default configuration.

Command Mode

Line Configuration mode

User Guidelines

There are no user guidelines for this command.

Example

The following example specifies a password "abc" on a line.

```
console (config-line) # password abc
```

5.3.9 enable password

The **enable password** global configuration command sets a local password to control access to normal and privilege levels. To remove the password requirement, use the **no** form of this command.

Syntax

enable password [**level** *level*] *password* [**encrypted**]

no enable password [**level** *level*]

- *password* — Password for this level, from 1 to 159 characters in length.
- **level** *level* — Level for which the password applies. If not specified the level is 15 (Range: 1-15).
- **encrypted** — Encrypted password entered, copied from another device configuration.

Default Configuration

This command has no default configuration.

Command Mode

Global Configuration mode

User Guidelines

There are no user guidelines for this command.

Example

The following example sets a local level 15 password "abc" to control access to user and privilege levels.

```
console (config-line) # enable password level 15 abc
```

5.3.10 username

The **username** global configuration command establishes a username-based authentication system. To remove a user name use the **no** form of this command.

Syntax

username *name* [**password** *password*] [**privilege** *level*] [**encrypted**]

no username

- *name* — The name of the user.
- *password* — The authentication password for the user, from 1 to 159 characters in length.
- *level* — The user level (Range: 1 -15).
- **encrypted** — Encrypted password entered, copied from another device configuration.

Default Configuration

The default privilege level is 1.

Command Mode

Global Configuration mode

User Guidelines

Up to 30 users can be defined on the device.

Example

The following example configures user "bob" with the password "lee" and user level 15 to the system.

```
console (config)# username bob password lee level 15
```

5.3.11 show users accounts

The **show users accounts** privileged EXEC command displays information about the local user database.

Syntax

show users accounts

Default Configuration

This command has no default configuration.

Command Mode

Privileged EXEC mode

User Guidelines

There are no user guidelines for this command.

Example

The following example displays the local users configured with access to the system.

```
console (config)# show users accounts
Username          Privilege
-----          -
Bob               15
Robert            15
```

5.4 Address Table Commands

5.4.1 bridge address

The **bridge address** VLAN interface configuration command adds a static MAC-layer station source address to the bridge table.

To delete the MAC address, use the **no** form of the **bridge address** command (using the **no** form of the command without

specifying a MAC address deletes all static MAC addresses belonging to this VLAN).

Syntax

bridge address *mac-address* {**ethernet** *interface* | **port-channel** *port-channel-number*} [**permanent** | **delete-onreset** | **delete-on-timeout** | **secure**]

no bridge address [*mac-address*]

- *mac-address* — A valid MAC address.
- *Interface* — A valid Ethernet port.
- *port-channel-number* — A valid port-channel number.
- **permanent** — The address can only be deleted by the **no bridge address** command.
- **delete-on-reset** — The address is deleted after reset.
- **delete-on-timeout** — The address is deleted after "age out" time has expired.
- **secure** — The address is deleted after the port changes mode to unlock learning (**no port security** command). This parameter is only available when the port is in learning locked mode.

Default Configuration

No static addresses are defined. The default mode for an added address is **permanent**.

Command Mode

Interface configuration (VLAN) mode

User Guidelines

There are no user guidelines for this command.

Example

The following example adds a permanent static MAC-layer station source address 3aa2.64b3.a245 on port e8 to the bridge table.

```
console (config)# interface vlan 2
console (config-vlan)# bridge address 3aa2.64b3.a245 ethernet e8 permanent
```

5.4.2 bridge multicast filtering

The **bridge multicast filtering** global configuration command enables filtering of multicast addresses. To disable filtering of multicast addresses, use the **no** form of the **bridge multicast filtering** command.

Syntax

bridge multicast filtering

no bridge multicast filtering

Default Configuration

Disabled. All multicast addresses are flooded to all ports of the relevant VLAN.

Command Mode

Global Configuration mode

User Guidelines

If multicast routers exist on the VLAN and IGMP-snooping is not enabled, the **bridge multicast forward-all** command should be used to enable forwarding all multicast packets to the multicast routers.

Example

In this example, bridge multicast filtering is enabled.

```
console (config)# bridge multicast filtering
```

5.4.3 bridge multicast address

The **bridge multicast address** interface configuration command registers MAC-layer multicast addresses to the bridge table, and adds static ports to the group. To unregister the MAC address, use the **no** form of the **bridge multicast address** command.

Syntax

bridge multicast address {*mac-multicast-address* | *ip-multicast-address*}

bridge multicast address {*mac-multicast-address* | *ip-multicast-address*} [**add** | **remove**] {**ethernet** *interface-list* | *port-channel* *port-channel-number-list*}

no bridge multicast address {*mac-multicast-address* | *ip-multicast-address*}

- **add** — Adds ports to the group. If no option is specified, this is the default option.
- **remove** — Removes ports from the group.
- *mac-multicast-address* — MAC multicast address.
- *ip-multicast-address* — IP multicast address.
- *interface-list* — Separate nonconsecutive Ethernet ports with a comma and no spaces; a hyphen is used to designate a range of ports.
- *port-channel-number-list* — Separate nonconsecutive port-channels with a comma and no spaces; a hyphen is used to designate a range of ports.

Default Configuration

No multicast addresses are defined.

Command Mode

Interface configuration (VLAN) mode

User Guidelines

If the command is executed without **add** or **remove**, the command only registers the group in the bridge database. Static

multicast addresses can only be defined on static VLANs.

Examples

The following example registers the MAC address:

```
console (config)# interface vlan 8
console (config-if)# bridge multicast address 0100.5e02.0203
```

The following example registers the MAC address and adds ports statically.

```
console (config)# interface vlan 8
console (config-if)# bridge multicast address 0100.5e02.0203 add Ethernet g1-9
```

5.4.4 bridge multicast forbidden address

The **bridge multicast forbidden address** interface configuration command forbids adding a specific multicast address to specific ports.

Syntax

bridge multicast forbidden address {*mac-multicast-address* | *ip-multicast-address*} {**add** | **remove**} {**Ethernet** *interface-list* | *port-channel* *port-channel-number-list*}

no bridge multicast forbidden address {*mac-multicast-address* | *ip-multicast-address*}

- **add** — Adds ports to the group.
- **remove** — Removes ports from the group.
- *mac-multicast-address* — MAC multicast address.
- *ip-multicast-address* — IP multicast address.
- *interface-list* — Separate non consecutive valid Ethernet ports with a comma and no spaces; hyphen is used to designate a range of ports.
- *port-channel-number-list* — Separate non consecutive valid port-channels with a comma and no spaces; a hyphen is used to designate a range of port-channels.
-
-

Default Configuration

No forbidden addresses are defined.

Command Modes

Interface Configuration (VLAN) mode

User Guidelines

Before defining forbidden ports, the multicast group should be registered.

Examples

In this example the MAC address 0100.5e02.0203 is forbidden on port g9 within VLAN 8.

```
console (config)# interface vlan 8
console (config-if)# bridge multicast address 0100.5e02.0203
console (config-if)# bridge multicast forbidden address 0100.5e02.0203 add ethernet e9
```

3.4.5 bridge multicast forward-unregistered

The **bridge multicast forward-unregistered** interface configuration command enables forwarding unregistered multicast addresses. Use the **no** form of this command to return to default.

Syntax

bridge multicast forward-unregistered {add | remove} {**ethernet** *interface-list* | **port-channel** *port-channel-number-list*}

no bridge multicast forward-unregistered

- add — Force forwarding of unregistered multicast packets.
- remove — Don't force forwarding of unregistered multicast packets.
- interface-list — Separate nonconsecutive Ethernet ports with a comma and no spaces; use a hyphen to designate a range of ports. (Range: Valid Ethernet port)
- port-channel-number-list — Separate nonconsecutive port-channels with a comma and no spaces; use a hyphen to designate a range of port-channels. (Range: Valid Port-channel number)

Default Configuration

Forward

Command Modes

Interface configuration (VLAN) mode

User Guidelines

If routers exist on the VLAN, do not change the unregistered multicast addresses state to drop on the routers ports.

Examples

This example enables forwarding unregistered multicast addresses within VLAN 8.

```
console (config)# interface vlan 8
console (config-if)# bridge multicast forward-unregistered add ethernet 1- 9
```

5.4.6 bridge multicast forbidden forward-unregistered

The **bridge multicast forbidden forward-unregistered** interface configuration command forbids a port to be a Forwarding-unregistered-multicast-addresses port. Use the **no** form of this command to return to default.

Syntax

bridge multicast forbidden forward-unregistered {**add** | **remove**} {**ethernet** *interface-list* | **port-channel** *portchannel-number-list* }

no bridge multicast forbidden forward-unregistered

- **add** — Forbid forwarding unregistered multicast packets.
- **remove** — Don't forbid forwarding unregistered multicast packets.
- **interface-list** — Separate nonconsecutive Ethernet ports with a comma and no spaces; use a hyphen to designate a range of ports. (Range: Valid Ethernet port)
- **port-channel-number-list** — Separate nonconsecutive port-channels with a comma and no spaces; use a hyphen to designate a range of port-channels. (Range: Valid Port-channel number)

Default Configuration

Not forbidden

Command Modes

Interface configuration (VLAN) mode

User Guidelines

There are no user guidelines for this command.

Examples

This example forbids port 1 to be a Forwarding-unregistered-multicast-addresses port within VLAN 8.

```
console (config)# interface vlan 8
console (config-if)# bridge multicast forward-unregistered add ethernet 1
```

5.4.7 bridge multicast forward-all

The **bridge multicast forward-all** interface configuration command enables forwarding of all multicast packets on a port. To restore the default, use the **no** form of the **bridge multicast forward-all** command.

Syntax

bridge multicast forward-all {**add** | **remove**} {**ethernet** *interface-list* | **port-channel** *port-channel-number-list*}

no bridge multicast forward-all

- **add** — Adds ports to the group.
- **remove** — Removes ports from the group.
- **interface-list** — Separate non consecutive valid Ethernet ports with a comma and no spaces; a hyphen is used to designate a range of ports.

- *port-channel-number-list* — Separate non consecutive valid port-channels with a comma and no spaces; a hyphen is used to designate a range of port-channels.

Default Configuration

Disable forward-all on all ports.

Command Mode

Interface Configuration (VLAN) mode

User Guidelines

There are no user guidelines for this command.

Example

In this example all multicast packets on port g8 are forwarded.

```
console (config)# interface vlan 2
console (config-if)# bridge multicast forward-all add ethernet g8
```

5.4.8 bridge multicast forbidden forward-all

The **bridge multicast forbidden forward-all** interface configuration command forbids a port to be a forward-allmulticast port.

To restore the default, use the **no** form of the **bridge multicast forward-all** command.

Syntax

bridge multicast forbidden forward-all {**add** | **remove**} {**ethernet** *interface-list* | *port-channel port-channel-number-list*}

no bridge multicast forward-all

- **add** — Forbids forwarding all multicast packets.
- **remove** — Does not forbid forwarding all multicast packets.
- *interface-list* — Separates non consecutive valid Ethernet ports with a comma and no spaces; a hyphen is used to designate a range of ports.
- *port-channel-number-list* — Separates non consecutive valid port-channels with a comma and no spaces; a hyphen is used to designate a range of port-channels.

Default Configuration

By default, this setting is disabled (for example, forwarding to the port is not forbidden).

Command Mode

Interface Configuration (VLAN) mode

User Guidelines

IGMP snooping dynamically discovers multicast router ports. When a multicast router port is discovered, all the multicast packets are forwarded to it unconditionally.

This command prevents a port to be a multicast router port.

Example

In this example, forwarding all multicast packets to e6 are forbidden.

```
console (config)# interface vlan 2
console (config-if)# bridge multicast forbidden forward-all add ethernet e6
```

5.4.9 bridge aging-time

The **bridge aging-time** global configuration command sets the address table aging time. To restore the default, use the **no** form of the **bridge aging-time** command.

Syntax

bridge aging-time *seconds*

no bridge aging-time

- *seconds* — Time is number of seconds. (Range: 10 - 630 seconds)

Default Configuration

300 seconds

Command Mode

Global Configuration mode

User Guidelines

There are no user guidelines for this command.

Example

In this example the bridge aging time is set to 250.

```
console (config)# bridge aging-time 250
```

5.4.10 clear bridge

The **clear bridge** privileged EXEC command removes any learned entries from the forwarding database.

Syntax

clear bridge

This command has no keywords or arguments.

Default Configuration

This command has no default configuration.

Command Mode

Privileged EXEC mode

User Guidelines

There are no user guidelines for this command.

Example

In this example, the bridge tables are cleared.

```
console# clear bridge
```

5.4.11 port security

The **port security** interface configuration command locks the port. By locking the port, new addresses are not learned on the port. To enable new address learning, use the **no** form of the **port security** command.

Syntax

port security [**forward** | **discard** | **discard-shutdown**] [**trap** *seconds*]

no port security

- **forward** — Forwards frames with unlearned source addresses, but does not learn the address.
- **discard** — Discards frames with unlearned source addresses. This is the default if no option is indicated.
- **discard-shutdown** — Discards frames with unlearned source addresses. The port is also shut down.
- **trap** *Seconds* — Sends SNMP traps and defines the minimal amount of time in seconds between two consecutive traps.
(Range: 1 - 1,000,000)

Default Configuration

Disabled - No port security

Command Mode

Interface Configuration (Ethernet, port-channel) mode

User Guidelines

There are no user guidelines for this command.

Example

In this example, frame forwarding is enabled without learning, and with traps sent every 100 seconds on port e18.

```
console (config)# interface ethernet e18
console (config-if)# port security forward trap 100
```

5.4.12 port security routed secure-address

The **port security routed secure-address** interface configuration command adds MAC-layer secure addresses to a routed

port. Use the **no** form of this command to delete the MAC addresses.

Syntax

port security routed secure-address *mac-address*

no port security routed secure-address *mac-address*

- *mac-address* — Specify a MAC address.

Default Configuration

No addresses are defined.

Command Mode

Interface configuration (Ethernet, port-channel). Cannot be configured for a range of interfaces (range context).

User Guidelines

The command enables adding secure MAC addresses to a routed ports in port security mode. The command is available when the port is a routed port and in port security mode. The address is deleted if the port exits the security mode or is not a routed port.

Example

In this example, the MAC-layer address 66:66:66:66:66:66 is added to port g1.

```
console (config)# interface ethernet g1
console (config-if)# port security routed secure-address 66:66:66:66:66:66
```

5.4.13 show bridge address-table

The **show bridge address-table** privileged EXEC command displays all entries in the bridge-forwarding database.

Syntax

show bridge address-table [*vlan vlan*] [*ethernet interface* | *port-channel port-channel-number*]

- *vlan* — Specific valid VLAN, such as VLAN 1.
- *Interface* — A valid Ethernet port.
- *port-channel-number* — A valid port-channel number.

Default Configuration

This command has no default configuration.

Command Mode

Privileged EXEC mode

User Guidelines

There are no user guidelines for this command.

Example

In this example, all classes of entries in the bridge-forwarding database are displayed.

```
console# show bridge address-table
Aging time is 250 sec
vlan          mac address          port          type
-----          -
1             0060.704C.73FF       e8            dynamic
1             0060.708C.73FF       e8            dynamic
200          0010.0D48.37FF       e8            static
```

5.4.14 show bridge address-table static

The **show bridge address-table static** privileged EXEC command displays statically created entries in the bridge-forwarding database.

Syntax

show bridge address-table static [**vlan** *vlan*] [**ethernet** *interface* | **port-channel** *port-channel-number*]

- *vlan* — Specific valid VLAN, such as VLAN 1.
- *interface* — A valid Ethernet port.
- *port-channel-number* — A valid port-channel number.

Default Configuration

This command has no default configuration.

Command Mode

Privileged EXEC mode

User Guidelines

There are no user guidelines for this command.

Example

In this example, all static entries in the bridge-forwarding database are displayed.

```
console# show bridge address-table static
Aging time is 300 sec

vlan          mac address          port          type
-----          -
1             0060.704C.73FF       e8            permanent
1             0060.708C.73FF       e8            delete-on-timeout
200          0010.0D48.37FF       e8            delete-on-reset
```

5.4.15 show bridge address-table count

The **show bridge address-table count** privileged EXEC command displays the number of addresses present in all VLANs or at a specific VLAN.

Syntax

show bridge address-table count [*vlan* *vlan*]

- *vlan* — Specific VLAN.

Default Configuration

This command has no default configuration.

Command Mode

Privileged EXEC mode

User Guidelines

There are no user guidelines for this command.

Example

In this example, the number of addresses present in the VLANs are displayed.

```

console# show bridge address-table count

Capacity: 8192
Free: 8084
Used: 108
Secure: 0
Dynamic addresses: 97
Static addresses: 2
Internal addresses: 9

vlan          Dynamic          Static
-----          -
1              75              1
19            22              1

```

5.4.16 show bridge multicast address-table

The **show bridge multicast address-table** privileged EXEC command displays multicast MAC address table information.

Syntax

show bridge multicast address-table [*vlan* *vlan-id*] [**address** *mac-multicast-address* | *ip-multicast-address*] [**format** *ip* | *mac*]

- *vlan_id* — A VLAN ID value.
- *mac-multicast-address* — A MAC multicast address.
- *ip-multicast-address* — An IP multicast address.
- **format** — Multicast address format. Can be **ip** or **mac**. If format is unspecified, the default is **mac**.

Default Configuration

This command has no default configuration.

Command Mode

Privileged EXEC mode

User Guidelines

There are no user guidelines for this command.

Example

In this example, multicast MAC address table information is displayed.

```
console # show bridge multicast address-table
```

| Vlan | MAC Address | Type | Ports |
|------|----------------|---------|--------|
| 1 | 0100.5e02.0203 | static | e1, g2 |
| 19 | 0100.5e02.0208 | static | e1-8 |
| 19 | 0100.5e02.0208 | dynamic | e9-11 |

Forbidden ports for multicast addresses:

| Vlan | MAC Address | Ports |
|------|----------------|-------|
| 1 | 0100.5e02.0203 | e8 |
| 19 | 0100.5e02.0208 | e8 |

```
console # show bridge multicast address-table format ip
```

| Vlan | IP Address | Type | Ports |
|------|-------------------|---------|-------|
| 1 | 224-239.130 2.2.3 | static | e1,g2 |
| 19 | 224-239.130 2.2.8 | static | e1-8 |
| 19 | 224-239.130 2.2.8 | dynamic | e9-11 |

Forbidden ports for multicast addresses:

| Vlan | IP Address | Ports |
|------|-------------------|-------|
| 1 | 224-239.130 2.2.3 | e8 |
| 19 | 224-239.130 2.2.8 | e8 |

5.4.17 show bridge multicast filtering

The **show bridge multicast filtering** privileged EXEC command displays the multicast filtering configuration.

Syntax

show bridge multicast filtering *vlan-id*

- *vlan_id* — A valid VLAN ID value.

Default Configuration

This command has no default configuration.

Command Mode

Privileged EXEC mode

User Guidelines

There are no user guidelines for this command.

Example

In this example, the multicast configuration for VLAN 1 is displayed.

```
console # show bridge multicast filtering 1
Filtering: Enabled
VLAN: 1
Forward-All

Port          Static          Status
-----
e1            Forbidden      Filter
e2            Forward        Forward(s)
e3            -              Forward(d)
```

5.4.18 show ports security

The **show ports security** privileged EXEC command displays the port-lock status.

Syntax

show ports security [*ethernet interface* | **port-channel** *port-channel-number*]

- *interface* — A valid Ethernet port.
- *port-channel-number* — A valid port-channel number.

Default Configuration

This command has no default configuration.

Command Mode

Privileged EXEC mode

User Guidelines

There are no user guidelines for this command.

Example

In this example, all classes of entries in the port-lock status are displayed.

```
console# show ports security
```

| Port | status | Learning | Action | Maximum | Trap | Frequency |
|------|----------|----------|--------|---------|------|-----------|
| e1 | Disabled | Lock | - | 1 | - | - |
| e2 | Disabled | Lock | - | 1 | - | - |
| e3 | Disabled | Lock | - | 1 | - | - |
| e4 | Disabled | Lock | - | 1 | - | - |
| e5 | Disabled | Lock | - | 1 | - | - |
| e6 | Disabled | Lock | - | 1 | - | - |
| e7 | Disabled | Lock | - | 1 | - | - |
| e8 | Disabled | Lock | - | 1 | - | - |

5.5 Clock Commands

5.5.1 clock set

The **clock set** privileged EXEC command manually sets the system clock.

Syntax

clock set *hh:mm:ss day month year*

or

clock set *hh:mm:ss month day year*

- *hh:mm:ss* — Current time in hours (military format), minutes, and seconds (0 - 23, mm: 0 - 59, ss: 0 - 59).
- *day* — Current day (by date) in the month (1 - 31).
- *month* — Current month using the first three letters by name (Jan, ..., Dec).
- *year* — Current year (2000 - 2097).

Default Configuration

This command has no default configuration.

Command Mode

Privileged EXEC mode

User Guidelines

There are no user guidelines for this command.

Example

The following example sets the system time to 13:32:00 on the 7th March 2005.

```
console# clock set 13:32:00 7 Mar 2005
```

5.5.2 clock source

The **clock source** Privileged EXEC command configures an external time source for the system clock.

Syntax

clock source {sntp}

no clock source

- **sntp** — SNTP servers

Default Configuration

No external clock source

Command Mode

Privileged EXEC mode

User Guidelines

There are no user guidelines for this command.

Examples

The following example configures an external time source for the system clock.

```
console# clock source sntp
```

5.5.3 clock timezone

The **clock timezone** global configuration command sets the time zone for display purposes. To set the time to Coordinated Universal Time (UTC), use the **no** form of this command.

Syntax

clock timezone *hours-offset* [**minutes** *minutes-offset*] [**zone** *acronym*]

no clock timezone

- *hours-offse t*— Hours difference from UTC. (Range: -12 – +13)
- **minutes** *minutes-offse t*— Minutes difference from UTC. (Range: 0 – 59)
- **zone** *acronym* —The acronym of the time zone. (Range: Up to 4 characters)

Default Configuration

UTC

Command Mode

Global Configuration mode

User Guidelines

The system internally keeps time in UTC, so this command is used only for display purposes and when the time is manually set.

Examples

The following example sets the timezone to 6 hours difference from UTC.

```
console# (config)# clock timezone -6 zone CST
```

5.5.4 clock summer-time

The **clock summer-time** global configuration command configures the system to automatically switch to summer time (daylight saving time). To configure the software to not automatically switch to summer time, use the **no** form of this command.

Syntax

clock summer-time recurring {**usa** | **eu** | {*week day month hh:mm week day month hh:mm*}} [**offset** *offset*] [**zone** *acronym*]

clock summer-time date *date month year hh:mm date month year hh:mm* [**offset** *offset*] [**zone** *acronym*]

clock summer-time date *month date year hh:mm month date year hh:mm* [**offset** *offset*] [**zone** *acronym*]

no clock summer-time

- **recurring** — Indicates that summer time should start and end on the corresponding specified days every year.
- **date** — Indicates that summer time should start on the first specific date listed in the command and end on the second specific date in the command.
- **usa** — The summer time rules are the United States rules.
- **eu** — The summer time rules are the European Union rules.

- *week* — Week of the month. (Range: 1 - 4, **first**, **last**)
- *day* — Day of the week (Range: first three letters by name, like **sun**)
- *date* — Date of the month (Range:1 - 31)
- *month* — Month (Range: first three letters by name)
- *year* — year - no abbreviation (Range: 2000 - 2097)
- *hh:mm* — Time in military format, in hours and minutes (Range:hh: 0 - 23, mm:0 - 59)
- **offset** *offset* — Number of minutes to add during summer time (Range: 1 - 1440).
- **zone** *acronym* — The acronym of the time zone to be displayed when summer time is in effect. If unspecified default to the timezone acronym. (Range: Up to 4 characters)

Default Configuration

Summer time is disabled.

offset *offset*—default is 60

zone *acronym*— If unspecified default to the timezone acronym

Command Mode

Global Configuration mode

User Guidelines

In both the **date** and **recurring** forms of the command, the first part of the command specifies when summer time begins, and the second part specifies when it ends. All times are relative to the local time zone. The start time is relative to standard time. The end time is relative to summer time. If the starting month is chronologically after the ending month, the system assumes that you are in the southern hemisphere.

USA rule for daylight saving time:

Start: First Sunday in April

End: Last Sunday in October

Time: 2 am local time

EU rule for daylight saving time:

Start: Last Sunday in March

End: Last Sunday in October

Time: 1.00 am (01:00) Greenwich Mean Time (GMT)

Examples

The following example sets summer time starting on the first Sunday in April at 2am and finishing on the last Sunday in October at 2 am.

```
Console (config)# clock summer-time recurring first sun apr 2:00 last sun oct 2:00
```

5.5.5 sntp authentication-key

The **sntp authentication-key** global configuration command defines an authentication key for Simple Network Time Protocol (SNTP). To remove the authentication key for SNTP, use the **no** form of this command.

Syntax

sntp authentication-key *number* **md5** *value*

no sntp authentication-key *number*

- *number* — Key number (Range: 1 - 4294967295)
- *value* — Key value (Range: Up to 8 characters)

Default Configuration

No authentication key is defined.

Command Mode

Global Configuration mode

User Guidelines

There are no user guidelines for this command.

Examples

The following example defines the authentication key for SNTP.

```
console(config)# sntp authentication-key 8 md5 ClkKey
console(config)# sntp trusted-key 8
console(config)# sntp authenticate
```

5.5.6 sntp authenticate

The **sntp authenticate** global configuration command grants authentication for received Network Time Protocol (NTP) traffic from servers,. To disable the feature, use the **no** form of this command.

Syntax

sntp authenticate

no sntp authenticate

This command has no arguments or keywords.

Default Configuration

No authentication

Command Mode

Global Configuration mode

User Guidelines

The command is relevant for both unicast and broadcast.

Examples

The following example defines the authentication key for SNTP and grants authentication.

```
cnsole(config)# sntp authentication-key 8 md5 ClkKey
console(config)# sntp trusted-key 8
console(config)# sntp authenticate
```

5.5.7 sntp trusted-key

The **sntp trusted-key** global configuration command authenticates the identity of a system to which Simple Network Time Protocol (SNTP) will synchronize. To disable authentication of the identity of the system, use the **no** form of this command.

Syntax

sntp trusted-key *key-number*

no sntp trusted-key *key-number*

- *key-number* — Key number of authentication key to be trusted. (Range: 1 - 4294967295)

Default Configuration

Not trusted.

Command Mode

Global configuration mode

User Guidelines

The command is relevant for both unicast and broadcast.

Examples

The following example authenticates key 8.

```
Console(config)# sntp authentication-key 8 md5 ClkKey
Console(config)# sntp trusted-key 8
Console(config)# sntp authenticate
```

5.5.8 sntp client poll timer

The **sntp client poll timer** global configuration command sets the polling time for the Simple Network Time Protocol (SNTP) client. To return to default, use the **no** form of this command.

Syntax

sntp client poll timer *seconds*

no sntp client poll timer

- *seconds* — Polling interval in seconds (Range: 60 - 1024)

Default Configuration

1024

Command Mode

Global configuration mode

User Guidelines

There are no user guidelines for this command.

Examples

The following example sets the polling time for the Simple Network Time Protocol (SNTP) client to 120 seconds.

```
Console(config)# sntp client poll timer 120
```

5.5.9 sntp broadcast client enable

The **sntp broadcast client enable** global configuration command enables the Simple Network Time Protocol (SNTP) broadcast clients. To disable the SNTP broadcast clients, use the **no** form of this command.

Syntax

sntp broadcast client enable

no sntp broadcast client enable

This command has no arguments or keywords.

Default Configuration

Disabled

Command Mode

Global configuration mode

User Guidelines

The **sntp broadcast client enable** interface configuration command enables the device to receive broadcast transmissions globally and on ALL interfaces.

Use the **sntp client enable** interface configuration command to enable sntp client on specific interface.

Examples

The following example enables the SNTP broadcast clients.

```
Console (config)#sntp broadcast client enable
```

5.5.10 sntp anycast client enable

The **sntp anycast client enable** global configuration command enables anycast client. To disable the polling for SNTP broadcast client, use the **no** form of this command.

Syntax

sntp anycast client enable

no sntp anycast client enable

This command has no arguments or keywords.

Default Configuration

Disabled

Command Mode

Global configuration

User Guidelines

Polling time is determined by the **sntp client poll timer** global configuration command.

Use the **sntp client enable** interface configuration command to enable sntp client on specific interface.

Examples

The following example enables anycast clients.

```
Console (config-if)# sntp anycast client enable
```

5.5.11 sntp client enable (interface)

The **sntp client enable** interface configuration command enables the Simple Network Time Protocol (SNTP) client on an interface. To disable the SNTP client, use the **no** form of this command.

Syntax

sntp client enable

no sntp client enable

This command has no arguments or keywords.

Default Configuration

Disabled

Command Mode

Interface configuration (Ethernet, Port-Channel, VLAN) mode

User Guidelines

Use the **sntp client enable** global configuration command to enable broadcast clients globally.

Use the **sntp anycast client enable** global configuration command to enable anycast clients globally.

Examples

The following example enables the SNTP client on the interface.

```
console (config)# sntp client enable
```

5.5.12 sntp unicast client enable

The **sntp unicast client enable** global configuration command enables the device to use the Simple Network Time Protocol (SNTP) to request and accept Network Time Protocol (NTP) traffic from servers. To disable requesting and accepting Network Time Protocol (NTP) traffic from servers, use the **no** form of this command.

Syntax

sntp unicast client enable

no sntp unicast client enable

This command has no arguments or keywords.

Default Configuration

Disabled

Command Mode

Global Configuration mode

User Guidelines

There are no user guidelines for this command.

Examples

The following example enables the device to use the Simple Network Time Protocol (SNTP) to request and accept Network Time Protocol (NTP) traffic from servers.

```
console (config)# sntp unicast client enable
```

5.5.13 sntp unicast client poll

The **sntp unicast client poll** global configuration command enables polling for the Simple Network Time Protocol (SNTP)

predefined unicast clients. To disable the polling for SNTP client, use the **no** form of this command.

Syntax

sntp unicast client poll

no sntp unicast client poll

This command has no arguments or keywords.

Default Configuration

Disabled

Command Mode

Global configuration mode

User Guidelines

Polling time is determined by the **sntp client poll timer** global configuration command.

Examples

The following example enables polling for the Simple Network Time Protocol (SNTP) predefined unicast clients.

```
console (config)# sntp unicast client poll
```

5.5.14 sntp server

The **sntp server** global configuration command configures the device to use the Simple Network Time Protocol (SNTP) to request and accept Network Time Protocol (NTP) traffic from a server. To remove a server from the list of NTP servers, use the **no** form of this command.

Syntax

sntp server *ip-address* | *hostname* [**poll**] [**key** *keyid*]

no sntp server *host*

- *ip-address* — IP address of the server. An out-of-band IP address can be specified as described in the usage guidelines
- *hostname* — Hostname of the server. (Range: 1 - 160 characters)
- **poll** — Enable polling.
- **key** *keyed* — Authentication key to use when sending packets to this peer. (Range:1 – 4294967295)

Default Configuration

No servers are defined.

Command Mode

Global Configuration mode

User Guidelines

Up to 8 sntp servers can be defined.

Use the sntp unicast client enables global configuration command to enable predefined unicast clients globally.

To enable polling you should also use the sntp unicast client poll global configuration command for global enabling.

Polling time is determined by the **sntp client poll timer** global configuration command.

To define an SNTP server on the out-of-band port, use the out-of-band IP address format: oob/ip-address.

Examples

The following example configures the device to accept Network Time Protocol (NTP) traffic from the server on 192.1.1.1

```
Console (config)# sntp server 192.1.1.1
```

5.5.15 show clock

The **show clock** user EXEC command displays the time and date from the system clock.

Syntax

show clock

Default Configuration

This command has no default configuration.

Command Mode

User EXEC mode

User Guidelines

There are no user guidelines for this command.

Example

The following example displays the time and date from the system clock.

```
Console# show clock
```

```
15:29:03 Jun 17 2005
```

5.5.16 show sntp configuration

The **show sntp configuration** Privileged EXEC command shows the configuration of the Simple Network Time Protocol (SNTP), use

Syntax

show sntp configuration

This command has no keywords or arguments.

Default Configuration

This command has no default configuration.

Command Mode

Privileged EXEC mode

User Guidelines

There are no user guidelines for this command.

Examples

```
Console# show sntp configuration
```

```
Polling interval: 7200 seconds.
```

```
MD5 Authentication keys: 8, 9
```

```
Authentication is required for synchronization.
```

```
Trusted Keys: 8,9
```

```
Unicast Clients Polling: Enabled.
```

| Server | Polling | Encryption Key |
|-------------|----------|----------------|
| ----- | ----- | ----- |
| 176.1.1.8 | Enabled | 9 |
| 176.1.8.179 | Disabled | Disabled |

```
Broadcast Clients: Enabled
```

```
Broadcast Clients Poll: Enabled
```

```
Broadcast Interfaces: 1/1, 1/3
```

```
OOB SNTP servers
```

| Server | Polling | Encryption Key |
|------------------|---------|----------------|
| ----- | ----- | ----- |
| 10.1.1.91 | Enabled | 9 |

```
Broadcast Clients: Enabled
```

```
Broadcast Clients Poll: Enabled
Broadcast Interfaces: 1/1, 1/3
```

5.5.17 show sntp status

The **show sntp status** Privileged EXEC command shows the status of the Simple Network Time Protocol (SNTP),

Syntax

show sntp status

This command has no keywords or arguments.

Default Configuration

This command has no default configuration.

Command Mode

Privileged EXEC mode

User Guidelines

There are no user guidelines for this command.

Examples

The following example shows the status of the SNTP.

```
Console# show sntp status
Clock is synchronized, stratum 4, reference is 176.1.1.8
Reference time is AFE2525E.70597B34 (00:10:22.438 PDT Jul 5 1993)

Unicast servers:
Server          Preference      Status          Last response    Offset          Delay
-----          -
176.1.1.8       Primary        Up              AFE252C1.6DBDDFF2  7.33           117.79
176.1.8.179     Secondary      Unknown         AFE21789.643287C9  8.98           189.19

Broadcast:
Interface       IP address      Last response
-----          -
176.1.1.8       Primary        AFE252C1.6DBDDFF2
```

| | | |
|-------------|-----------|-------------------|
| 176.1.8.179 | Secondary | AFE21789.643287C9 |
|-------------|-----------|-------------------|

5.6 Configuration and Image Files

5.6.1 copy

The **copy** privileged EXEC command copies files from a source to a destination.

Syntax

copy *source-url destination-url* [**snmp**]

- *source-url* — The source file location URL or reserved keyword being copied.
- *destination-url* — The destination file URL or reserved keyword.
- **snmp** — Used only when copying from /to **startup-config**. Specifies that the destination/source file is inSNMP format.

The following table displays keywords aliases to URL:

| Keyword | Source or destination |
|----------------|--|
| running-config | Represents the current running configuration file. |
| startup-config | Represents the startup configuration file. |
| backup-config | Represents the backup configuration file. |
| Image | The image is executable code which is decompressed during system startup, into the switching and routing software that manages the device. There are always two images stored in the device flash known as "image-1" and "image-2". The images do not necessarily have to contain the same versions of the software. One of these images is always marked as active and the other image serves as a back-up. The "active" image is either the last downloaded image or the image configured as the "active" image. The switch boot code first tries to load and run the active image. However, if the active image is found to be corrupt, the boot code tries to load the back-up image. If the backup image is also corrupt the boot code prompts the user to initiate the Xmodem transfer of a valid image through the serial connection. The image file name is in the format 6024_abcd.dos, where abcd represents the release number. |
| boot | Boot file. The name of the image is in the format 6024_boot_abcd.rfb, where abcd represents the release number. |
| tftp | Source or destination URL for a TFTP network server. The syntax for this alias is tftp : <i>[[//location]/directory]/filename</i> . |

| | |
|--------|--|
| Xmodem | Source for the file from a serial connection that uses the Xmodem protocol. |
| null | Null destination for copies or files. A remote file can be copied to null to determine its size. |

Default Configuration

This command has no default configuration.

Command Mode

Privileged EXEC mode

User Guidelines

The location of a file system dictates the format of the source or destination URL.

The startup-config and the backup-config files cannot be copied to the running-config file.

The entire copying process may take several minutes and differs from protocol to protocol and from network to network.

Filenames cannot be a substring of "startup-config" or "running-config". e.g. the following filenames are not allowed: "s", "st", "sta".

File download from a TFTP server may take a long time, and therefore fail, if there are many Quality of Service elements (ACLs, policers, etc.) present. In this case, it is recommended to copy the TFTP file to the backup configuration file, and then copy the backup file to the running / startup configuration file.

When using tftp to copy files, it is recommended to set the tftp server timeout to 10-20 second.

The device does not accept new commands while files are being copied; however, the user does not receive notification that the device is busy copying, and will "ignore" the command. Note that this behavior occurs only at the session, which initiated the copy command; response to activity on other management sessions will result in a delay, but will not be ignored.

When a file is copied to the running configuration file or to the startup configuration file, the data in the file is checked. If the check fails, the file is not downloaded, and the user is notified of the error. However, the user should use caution when copying a file from a TFTP server to the backup configuration file, because there is no check of data. An attempt to display the corrupted backup configuration file (show backup) will result in information which is meaningless to the user (or even a blank row).

The device does not accept new commands while files are being copied; however, the user does not receive notification that the device is busy copying, and will "ignore" the command. Note that this behavior occurs only at the session, which initiated the copy command; response to activity on other management sessions will result in a delay, but will not be ignored.

Understanding Invalid Combinations of Source and Destination

Some invalid combinations of source and destination exist. Specifically, the following cannot be copied:

If the source file and destination file are the same file.

xmodem cannot be a destination. Can only be copied to **image**, **boot** and **null**.

tftp cannot be the source and destination on the same copy.

Copy Character Descriptions:

| Character | Description |
|-----------|--|
| ! | For network transfers, an exclamation point indicates that the copy process is taking place. Each exclamation point indicates the successful transfer of ten packets (512 bytes each). |
| . | For network transfers, a period indicates that the copy process timed out. Many periods in a row typically mean that the copy process may fail. |

Copying image file from a Server to Flash Memory

Use the **copy source-url image** command to copy an image file from a server to Flash memory.

Copying boot file from a Server to Flash Memory

Use the **copy source-url boot** command to copy a boot file from a server to Flash memory.

Copying a Configuration File from a Server to the Running Configuration

Use the **copy source-url running-config** command to load a "configuration file" from a network server to the device "running configuration". The configuration is added to the "running configuration" as if the commands were typed in the command-line interface (CLI). The resulting configuration file is a combination of the previous "running configuration" and the loaded "configuration file", with the loaded "configuration file" having precedence.

Copying a Configuration File from a Server to the Startup Configuration

Use the **copy source-url startup-config** command to copy a "configuration file" from a network server to the device "startup configuration". These commands replace the startup configuration file with the copied configuration file.

Storing the Running or Startup Configuration on a Server

Use the copy **running-config destination-url** command to copy the current configuration file to a network server using TFTP.

Use the copy **startup-config destination-url** command to copy the "startup configuration" file to a network server.

The configuration file copy can serve as a backup copy.

Saving the Running Configuration to the Startup Configuration

Use the copy **running-config startup-config** command to copy the "running configuration" to the "startup configuration".

Backup the Running Configuration or Startup Configuration to the Backup Configuration

Use the copy **running-config file** command to backup the running configuration to a backup configuration file.

Use the copy **startup-config file** command to backup the startup configuration a backup configuration file **Specifying out-of-band addresses**

If you want to copy from/to a server on the out-of-band port use the out-of-band IP address format: *oob/ipaddress*.

Example

The following example copies a system image named file1 from the TFTP server with an IP address of 172.16.101.101 to non active image file.

```

Console# copy tftp://172.16.101.101/file1 image
Accessing file 'file1' on 172.16.101.101...
Loading file1 from 172.16.101.101:
!!!!!!!!!!!!!!!!!!!!!!!!!!!!!!!!!!!!!!!!!!!!!!!!!!!!!!!!!!!!!!!!!!!!!!!!!!!!
!!!!!!!!!!!!!!!!!!!!!!!!!!!!!!!!!!!!!!!!!!!!!!!!!!!!!!!!!!!!!!!!!!!!!!!!!!!!
!!!!!!!!!!!!!!!!!!!!!!!!!!!!!!!!!!!!!!!!!!!!!!!!!!!!!!!!!!!!!!!!!!!!!!!!!!!!
!!!! [OK]
Copy took 0:01:11 [hh:mm:ss]
Accessing file 'configfile' on oob/172.16.1.1...
Loading file1 from oob/172.16.1.1:
!!!!!!!!!!!!!!!!!!!!!!!!!!!!!!!!!!!!!!!!!!!!!!!!!!!!!!!!!!!!!!!!!!!!!!!!!!!!
!!!!!!!!!!!!!!!!!!!!!!!!!!!!!!!!!!!!!!!!!!!!!!!!!!!!!!!!!!!!!!!!!!!!!!!!!!!!
!!!!!!!!!!!!!!!!!!!!!!!!!!!!!!!!!!!!!!!!!!!!!!!!!!!!!!!!!!!!!!!!!!!!!!!!!!!!
!!!! [OK]
Copy took 0:0:23 [hh:mm:ss]

```

5.6.2 show startup-config

The **show startup-config** privileged EXEC command displays the startup configuration file contents.

Syntax

```
show startup-config
```

Default Configuration

There is no default configuration for this command.

Command Mode

Privileged EXEC mode

User Guidelines

There are no user guidelines for this command.

Examples

The following example displays the contents of the startup-config file.

```
Console# show startup-config  
software version 1.1  
hostname device  
interface ethernet 1/1  
ip address 176.242.100.100 255.255.255.0  
duplex full  
speed 1000  
interface ethernet 1/2  
ip address 176.243.100.100 255.255.255.0  
duplex full  
speed 1000
```

5.7 Ethernet Configuration Commands

5.7.1 interface ethernet

The **interface ethernet** global configuration command enters the interface configuration mode to configure an Ethernet type interface.

Syntax

interface ethernet *interface*

- *interface* — Valid Ethernet port.

Default Configuration

This command has no default configuration.

Command Mode

Global Configuration mode

User Guidelines

There are no user guidelines for this command.

Example

The following example enables ports g1 for configuration.

```
Console(config)# interface ethernet g1
Console(config-if)#
```

5.7.2 interface range ethernet

The **interface range ethernet** global configuration command enters the interface configuration mode to configure multiple Ethernet type interfaces.

Syntax

interface range ethernet {*port-range* | *all*}

- **port-range**—List of valid ports to add. Separate non consecutive ports with a comma and no spaces; a hyphen is used to designate a range of ports.
- **all**—All Ethernet ports.

Default Configuration

This command has no default configuration.

Command Mode

Global Configuration mode

User Guidelines

Commands under the interface range context are executed independently on each active interface in the range. If the command returns an error on one of the active interfaces, it does not stop executing commands on other active interfaces.

Example

The following example shows how ports e1 to e4 and ports g1 to g2 are grouped to receive the same command.

```
Console(config)# interface range ethernet e1 – e4, g1 - g2  
Console(config-if)#
```

5.7.3 shutdown

The **shutdown** interface configuration command disables interfaces. To restart a disabled interface, use the **no** form of this command.

Syntax

shutdown

no shutdown

Default Configuration

The interface is enabled.

Command Mode

Interface Configuration (Ethernet, port-channel, out-of-band Ethernet) mode

User Guidelines

There are no user guidelines for this command.

Examples

The following example disables Ethernet e5.

```
Console(config)# interface ethernet e5  
Console(config-if)# shutdown
```

The following example re-enables Ethernet port e5.

```
Console(config)# interface ethernet e5  
Console(config-if)# no shutdown
```

5.7.4 description

The **description** interface configuration command adds a description to an interface. To remove the description use the **no** form of this command.

Syntax

description *string*

no description

- *string*—Comment or a description of the port up to 64 characters.

Default Configuration

By default, the interface does not have a description.

Command Mode

Interface Configuration (Ethernet, port-channel, out-of-band Ethernet) mode

User Guidelines

There are no user guidelines for this command.

Example

The following example adds a description to the Ethernet e5.

```
Console(config)# interface ethernet e5
Console(config-if)# description RD_SW#3
```

5.7.5 speed

The **speed** interface configuration command configures the speed of a given Ethernet interface when not using auto-negotiation. To restore the default, use the **no** form of this command.

Syntax

speed {10 | 100 | 1000}

no speed

- **10**—Configures the port to 10 Mbps.
- **100**—Configures the port to 100 Mbps.
- **1000**—Configures the port to 1000 Mbps.

Default Configuration

Maximum port capability.

Command Mode

Interface Configuration (Ethernet, port-channel, out-of-band Ethernet) mode

User Guidelines

The command "**no speed**" in port-channel context returns each port in the port-channel to its maximum capability.

Before attempting to force a particular duplex mode the port operating at 10/100 Mbps, disable the auto-negotiation on that port.

Example

The following example configures the speed operation of Ethernet e5 to force 100-Mbps operation.

```
Console(config)# interface ethernet e5
Console(config-if)# speed 100
```

5.7.6 duplex

The **duplex** interface configuration command configures the full/half duplex operation of a given Ethernet interface when not using auto-negotiation. To restore the default, use the **no** form of this command.

Syntax

duplex {half | full}

no duplex

- **half**—Force half-duplex operation
- **full**—Force full-duplex operation

Default Configuration

The interface is set to full duplex.

Command Mode

Interface Configuration (Ethernet, out-of-band Ethernet) mode

User Guidelines

Before attempting to force a particular duplex mode on the port operating at 10/100 Mbps, disable the auto-negotiation on that port.

Half duplex mode can be set only for ports operating at 10 Mbps or 100 Mbps.

Example

The following example configures the duplex operation of Ethernet e5 to force full duplex operation.

```
Console(config)# interface ethernet e5
Console(config-if)# duplex full
```

5.7.7 negotiation

The **negotiation** interface configuration command enables auto-negotiation operation for the speed and duplex parameters of a given interface. To disable negotiation, use the **no** form of this command.

Syntax

negotiation

no negotiation

Default Configuration

auto-negotiation

Command Mode

Interface Configuration (Ethernet, port-channel, out-of-band Ethernet) mode

User Guidelines

Turning off auto-negotiation on an aggregate link may, under some circumstances, make it non-operational. If the other side has auto-negotiation turned on, it may re-synchronize all members of the aggregated link to half-duplex operation, and may, as per the standards, set them all inactive.

Example

The following example enables autonegotiation on Ethernet e5.

```
Console(config)# interface ethernet e5
Console(config-if)# negotiation
```

5.7.8 flowcontrol

The **flowcontrol** interface configuration command configures the Flow Control on a given interface. To restore the default, use the **no** form of this command.

Syntax

flowcontrol {**auto** | **on** | **off** | **rx** | **tx**}

no flowcontrol

- **auto**—Enables auto-negotiation of Flow Control.
- **on**—Enables Flow Control.
- **off**—Disables Flow Control.
- **rx**—Enables receiving pause frames only.
- **tx**—Enables transmitting pause frames only

Default Configuration

Flow Control is off.

Command Mode

Interface configuration (Ethernet, port-channel) mode

User Guidelines

Flow Control will operate only if duplex mode is set to FULL. Back Pressure will operate only if duplex mode is set to HALF.

When Flow Control is ON, the head-of-line-blocking mechanism of this port is disabled.

If a link is set to NOT use auto-negotiation, the other side of the link must also be configured to not use auto-negotiation.

To select **auto**, ensure negotiation for Flow Control is enabled.

Example

In the following example, Flow Control is enabled on e5.

```
Console(config)# interface ethernet e5
Console(config-if)# flowcontrol on
```

5.7.9 mdix

The **mdix** interface configuration command enables automatic crossover on a given interface. To disable automatic crossover, use the **no** form of this command.

Syntax

mdix {on | auto}

no mdix

- **on**—Manual mdix
- **auto**—Auto mdi/mdix

Default Configuration

Automatic crossover is enabled

Command Mode

Interface Configuration (Ethernet) mode

User Guidelines

Mdix Auto : All possibilities to connect a PC with cross OR normal cables are supported and are automatically detected.

Mdix ON: It is possible to connect to a PC only with a normal cable and to connect to another switch ONLY with a cross cable.

If MDIX is set to "no mdix", the device works opposite from the "MDIX On" behavior. It is possible to connect to PC only with cross cable, and to connect to another switch ONLY with Normal cable

Example

In the following example, automatic crossover is enabled on g2.

```
Console(config)# interface ethernet g2
Console(config-if)# mdix auto
```

5.7.10 back-pressure

The **back-pressure** interface configuration command enables Back Pressure on a given interface. To disable Back Pressure, use the **no** form of this command.

Syntax

back-pressure

no back-pressure

Default Configuration

Back Pressure is disabled.

Command Mode

Interface Configuration (Ethernet, port-channel) mode

User Guidelines

Back Pressure will operate only if duplex mode is set to half.

Example

In the following example Back Pressure is enabled on e5.

```
Console(config)# interface ethernet e5
Console(config-if)# back-pressure
```

5.7.11 port jumbo-frame

The **port jumbo-frame** global configuration command enables jumbo frames for the device. To disable jumbo frames, use the **no** form of this command.

Syntax

port jumbo-frame

no port jumbo-frame

Default Configuration

Jumbo Frames are not enabled.

Command Mode

Global Configuration mode

User Guidelines

There are no user guidelines for this command.

Example

In the following example, Jumbo Frames are enabled on the device.

```
Console# port jumbo-frame
```

5.7.12 clear counters

The **clear counters** user EXEC mode command clears statistics on an interface.

Syntax

clear counters [*ethernet interface* | **port-channel** *port-channel-number*]

- *Interface* — Valid Ethernet port.
- *port-channel-number* — Valid port-channel trunk index.

Default Configuration

This command has no default configuration.

Command Mode

User EXEC mode

User Guidelines

There are no user guidelines for this command.

Example

In the following example, the counters for interface g1 are cleared.

```
console# clear counters ethernet g1
```

5.7.13 set interface active

The **set interface active** privileged EXEC mode command reactivates an interface that was suspended by the system.

Syntax

set interface active {**ethernet** *interface* | **port-channel** *port-channel-number*}

- *interface* — Valid Ethernet port.
- *port-channel-number* — Valid port-channel trunk index.

Default Configuration

This command has no default configuration.

Command Mode

Privilege EXEC mode

User Guidelines

There are no user guidelines for this command.

Example

The following example activates interface e5, which is disabled.

```
console# set interface active ethernet e5
```

5.7.14 show interfaces configuration

The **show interfaces configuration** Privilege EXEC mode command displays the configuration for all configured interfaces.

Syntax

show interfaces configuration [**ethernet** *interface* | **port-channel** *port-channel-number* |]

- *Interface* — Valid Ethernet port.
- *port-channel-number* — Valid port-channel trunk index.
- *oob-interface* — Out-of-band Ethernet port number.

Default Configuration

This command has no default configuration.

Command Modes

Privilege EXEC mode

User Guidelines

There are no user guidelines for this command.

Example

The following example displays the configuration for all configured interfaces:

```
console# show interfaces configuration
```

| Port | Type | Duplex | Speed | Neg | Flow control | Admin State | Back Pressure | Mdix Mode |
|------|-------------|--------|-------|---------|--------------|-------------|---------------|-----------|
| e1 | 100M-Copper | Full | 100 | Enabled | Off | Up | Disabled | Auto |
| e2 | 100M-Copper | Full | 100 | Enabled | Off | Up | Disabled | Auto |
| e3 | 100M-Copper | Full | 100 | Enabled | Off | Up | Disabled | Auto |
| e4 | 100M-Copper | Full | 100 | Enabled | Off | Up | Disabled | Auto |
| e5 | 100M-Copper | Full | 100 | Enabled | Off | Up | Disabled | Auto |
| e6 | 100M-Copper | Full | 100 | Enabled | Off | Up | Disabled | Auto |
| e7 | 100M-Copper | Full | 100 | Enabled | Off | Up | Disabled | Auto |
| e8 | 100M-Copper | Full | 100 | Enabled | Off | Up | Disabled | Auto |
| g1 | 1G-Combo-C | Full | 1000 | Enabled | Off | Up | Disabled | Auto |
| g2 | 1G-Combo-C | Full | 1000 | Enabled | Off | Up | Disabled | Auto |

| Ch | Type | Speed | Neg | Flow control | Admin State |
|-----|------|-------|---------|--------------|-------------|
| ch1 | -- | -- | Enabled | Off | Up |
| ch2 | -- | -- | Enabled | Off | Up |
| ch3 | -- | -- | Enabled | Off | Up |
| ch4 | -- | -- | Enabled | Off | Up |
| ch5 | -- | -- | Enabled | Off | Up |
| ch6 | -- | -- | Enabled | Off | Up |
| ch7 | -- | -- | Enabled | Off | Up |
| ch8 | -- | -- | Enabled | Off | Up |

The displayed port configuration information includes the following:

- **Port**—The port number.
- **Port Type**—The port designated IEEE shorthand identifier. For example 1000Base-T refers to 1000 Mbps baseband signaling including both Tx and Rx transmissions.
- **Duplex**—Displays the port Duplex status.
- **Speed**—Refers to the port speed.
- **Neg**—Describes the Auto-negotiation status.
- **Flow Control**—Displays the Flow Control status.
- **Back Pressure**—Displays the Back Pressure status.
- **MDIX Mode**—Displays the Auto-crossover status.
- **Admin State**—Displays whether the port is enabled or disabled.

5.7.15 show interfaces status

The **show interfaces status** user EXEC command displays the status for all configured interfaces.

Syntax

show interfaces status [**ethernet interface** | **port-channel** *port-channel-number* | **out-of-band-eth** *oob-interface*]

- *Interface* — A valid Ethernet port.

- *port-channel-number* — A valid port-channel trunk index.
- *oob-interface* — Out of band Ethernet port number.

Default Configuration

This command has no default configuration.

Command Mode

Privilege EXEC mode

User Guidelines

There are no user guidelines for this command.

Example

The following example displays the status for all configured interfaces.

```
Console# show interfaces status
```

| Port | Type | Duplex | Speed | Neg | Flow Control | Link State | Back Pressure | Mdix Mode |
|------|------|--------|-------|------|--------------|------------|---------------|-----------|
| e1 | 100 | Full | 100 | Auto | On | Up | Enable | On |
| e1 | 100 | Full | 100 | Off | Off | Down | Disable | Off |
| e2 | 100 | Full | 100 | Off | Off | Up | Disable | On |

| Ch | Type | Duplex | Speed | Neg | Flow Control | Back Pressure | Link State |
|----|------|--------|-------|-----|--------------|---------------|------------|
| 1 | 1000 | Full | 1000 | Off | Off | Disable | Up |

The displayed port status information includes the following:

- **Port**—The port number.
- **Description**—If the port has a description, the description is displayed.
- **Port Type**—The port designated IEEE shorthand identifier. For example, 1000Base-T refers to 1000 Mbps baseband signaling including both Tx and Rx transmissions.
- **Duplex**—Displays the port Duplex status.
- **Speed**—Refers to the port speed.
- **Neg**—Describes the Auto-negotiation status.
- **Flow Control**—Displays the Flow Control status.
- **Back Pressure**—Displays the Back Pressure status.
- **Link State**—Displays the Link Aggregation status.

5.7.16 show interfaces description

The **show interfaces description** user EXEC command displays the description for all configured interfaces.

Syntax

show interfaces description [**ethernet interface** | **port-channel** *port-channel-number*] **out-of-band--eth** *oobinterface*]

- *Interface* — Valid Ethernet port.
- *port-channel-number* — A valid port-channel trunk index.
- *oob-interface* — Out-of-band Ethernet port number.

Default Configuration

This command has no default configuration.

Command Modes

Privilege EXEC mode

User Guidelines

There are no user guidelines for this command.

Example

The following example displays the description for the interface g1.

```

Console# show interfaces description ethernet g1

Port      Description
-----  -
e1        Management_port
e2        R&D_port
e3        Finance_port

Ch        Description
-----  -
1         Output

```

5.7.17 show interfaces counters

The **show interfaces counters** user EXEC command displays traffic seen by the physical interface.

Syntax

show interfaces counters [**ethernet** *interface* | **port-channel** *port-channel-number*]

- *interface* — A valid Ethernet port.
- *port-channel-number* — A valid port-channel index.

Default Configuration

This command has no default configuration.

Command Modes

Privilege EXEC mode

User Guidelines

There are no user guidelines for this command.

Examples

The following example displays traffic seen by the physical interface:

```

Console# show interfaces counters

```

| Port | InOctets | InUcastPkts | InMcastPkts | InBcastPkts |
|------|----------|-------------|-------------|-------------|
| e1 | 183892 | 1289 | 987 | 8 |
| e2 | 0 | 0 | 0 | 0 |
| e3 | 123899 | 1788 | 373 | 19 |

| Port | OutOctets | OutUcastPkts | OutMcastPkts | OutBcastPkts |
|------|-----------|--------------|--------------|--------------|
| e4 | 9188 | 9 | 8 | 0 |
| e5 | 0 | 0 | 0 | 0 |
| e6 | 8789 | 27 | 8 | 0 |

| Ch | InOctets | InUcastPkts | InMcastPkts | InBcastPkts |
|----|----------|-------------|-------------|-------------|
| 1 | 27889 | 928 | 0 | 78 |

| Ch | OutOctets | OutUcastPkts | OutMcastPkts | OutBcastPkts |
|----|-----------|--------------|--------------|--------------|
| 1 | 23739 | 882 | 0 | 122 |

The following example displays counters for port g1.

```

Console# show interfaces counters ethernet g1

Port  OutOctets  OutUcastPkts  OutMcastPkts  OutBcastPkts
-----
g1    183892    1289          987           8

Port  OutOctets  OutUcastPkts  OutMcastPkts  OutBcastPkts
-----
g1    9188      9             8             0

FCS Errors: 8
Single Collision Frames: 0
Multiple Collision Frames: 0
SQE Test Errors: 0
Deferred Transmissions: 0
Late Collisions: 0
Excessive Collisions: 0
Internal MAC Tx Errors: 0
Carrier Sense Errors: 0
Oversize Packets: 0
Internal MAC Rx Errors: 0
Received Pause Frames: 0
Transmitted Pause Frames: 0

```

The following table describes the fields shown in the display:

| Field | Description |
|--------------|--|
| InOctets | Counted received octets. |
| InUcastPkts | Counted received unicast packets. |
| InMcastPkts | Counted received multicast packets. |
| InBcastPkts | Counted received broadcast packets. |
| OutOctets | Counted transmitted octets. |
| OutUcastPkts | Counted transmitted unicast packets. |
| OutMcastPkts | Counted transmitted multicast packets. |

| | |
|--------------------------|---|
| OutBcastPkts | Counted transmitted broadcast packets. |
| FCS Errors | Counted frames received that are an integral number of octets in length but do not pass the FCS check. |
| Single Collision Frames | Counted frames that are involved in a single collision, and are subsequently transmitted successfully. |
| Late Collisions | Counted times that a collision is detected later than one slotTime into the transmission of a packet. |
| Excessive Collisions | Counted frames for which transmission fails due to excessive collisions. |
| Internal MAC Tx Errors | Counted frames for which transmission fails due to an internal MAC sublayer transmit error. |
| Oversize Packets | Counted frames received that exceed the maximum permitted frame size. |
| Internal MAC Rx Errors | Counted frames for which reception fails due to an internal MAC sublayer receive error. |
| Received Pause Frames | Counted MAC Control frames received with an opcode indicating the PAUSE operation. |
| Transmitted Pause Frames | Counted MAC Control frames transmitted on this interface with an opcode indicating the PAUSE operation. |

5.7.18 show ports jumbo-frame

The **show ports jumbo-frame** user EXEC command displays the jumbo frames configuration.

Syntax

show ports jumbo-frame

Default Configuration

This command has no default configuration.

Command Modes

User EXEC mode

User Guidelines

There are no user guidelines for this command.

Example

The following example displays the jumbo frames configuration.

```
Console# show ports jumbo-frame
Jumbo frames are disabled
```

Jumbo frames will be enabled after reset

5.7.19 port storm-control broadcast enable

The **port storm-control broadcast enable** interface configuration command enables broadcast storm control. To disable broadcast storm control, use the **no** form of this command.

Syntax

port storm-control broadcast enable

no port storm-control broadcast enable

Default Configuration

Broadcast storm control is disabled.

Command Modes

Interface Configuration (Ethernet) mode

User Guidelines

Use the port **storm-control broadcast rate** interface configuration command, to set the maximum allowable broadcast rate.

Multicast can be counted as part of the "storm" frames if the **port storm-control include-multicast** global configuration command is already executed.

Example

The following example enables broadcast storm control on port e5.

```
Console(config)# interface ethernet e5
Console(config-if)# port storm-control broadcast enable
```

5.7.20 port storm-control broadcast rate

The **port storm-control broadcast rate** interface configuration command configures the maximum broadcast rate. Use the **no** form of this command to configure the default value.

port storm-control broadcast rate *rate*

no port storm-control broadcast rate

- *rate*—Maximum of kilobytes per second of broadcast and multicast traffic on a port. (Rate: 70 - 100000)

Default Configuration

The default storm control broadcast rate is 12000.

Command Mode

Interface Configuration (Ethernet)

User Guidelines

Use the **port storm-control broadcast enable** interface configuration command to enable broadcast storm control.

The rate is rounded to the nearest 64 kbytes/sec (except 1 - 63 kbytes/sec, which is rounded to 64 bytes/sec).

Note that if the rate is 0, broadcast packets are not forwarded.

Example

The following example configures the maximum broadcast rate 100 kilobytes per second.

```
console(config)# interface ethernet g2

console(config-if)# port storm-control broadcast rate 100
```

5.7.21 show ports storm-control

The **show ports storm-control** privileged EXEC command displays the storm control configuration.

Syntax

show ports storm-control [*ethernet interface*]

- *ethernet interface*—A valid Ethernet port.

Default Configuration

This command has no default configuration.

Command Modes

Privileged EXEC mode

User Guidelines

There are no user guidelines for this command.

Example

The following example displays the storm control configuration.

```
Console# show ports storm-control

Port                               Broadcast Storm control [kbytes/sec]
-----                               -
```

| | |
|----|----------|
| e1 | 8000 |
| e2 | Disabled |
| e3 | Disabled |

5.8 GVRP Commands

5.8.1 gvrp enable (global)

GVRP, or GARP VLAN Registration Protocol, is an industry-standard protocol designed to propagate VLAN information from device to device. With GVRP, a single switch is manually configured with all desired VLANs for the network, and all other switches on the network learn these VLANs dynamically.

The **gvrp enable** global configuration command enables GVRP globally. To disable GVRP globally on the switch, use the **no** form of this command.

Syntax

gvrp enable

no gvrp enable

Default Configuration

GVRP is globally disabled.

Command Mode

Global Configuration mode

User Guidelines

There are no user guidelines for this command.

Example

The following example globally enables GVRP on the device.

```
Console (config)# gvrp enable
```

5.8.2 gvrp enable (interface)

The **gvrp enable** interface configuration command enables GVRP on an interface. To disable GVRP on an interface, use the **no** form of this command.

Syntax

gvrp enable

no gvrp enable

Default Configuration

GVRP is disabled on all interfaces by default.

Command Mode

Interface Configuration (Ethernet, port-channel) mode

User Guidelines

An access port would not dynamically join a VLAN because it is always a member in only one VLAN.

Example

The following example enables GVRP on ethernet g8.

```
Console (config)# interface ethernet e8
Console (config-if)# gvrp enable
```

5.8.3 garp timer

The **garp timer** interface configuration command adjusts the GARP application join, leave, and leaveall GARP timer values. To reset the timer to default values, use the **no** form of this command.

Syntax

garp timer {**join** | **leave** | **leaveall**} *timer_value*

no garp timer

- **join** — Indicates the time in milliseconds that PDUs are transmitted. (Range: 10-2147483640)
- **leave** — Indicates the amount of time in milliseconds that the device waits before leaving its GARP state. The Leave Time is activated by a Leave All Time message sent/received, and cancelled by the Join message. (Range: 10-2147483640)
- **leaveall** — Used to confirm the port within the VLAN. The time in milliseconds between messages sent. (Range: 10-2147483640)
- *timer_value* — Timer values in milliseconds.

Default Configuration

The default timer values are as follows:

Join timer — 200 milliseconds

Leave timer — 600 milliseconds

Leavall timer — 10000 milliseconds

Command Mode

Interface configuration (Ethernet, port-channel) mode

User Guidelines

The following *relationship* for the various timer values must be maintained:

Leave time must be greater than or equal to three times the join time.

Leaveall time must be greater than the leave time.

Set the same GARP timer values on all Layer 2-connected devices. If the GARP timers are set differently on Layer 2-connected devices, GARP application will not operate successfully.

As the number of dynamic VLANs (GVRP) increases, the leave time should be increased from the default value.

For example, if the number of dynamic VLANs is 400, it is recommended to increase the leave time.

Example

The following example sets the leave timer for port e8 to 900 milliseconds.

```
Console (config)# interface ethernet e8
Console (config-if)# garp timer leave 900
```

5.8.4 gvrp vlan-creation-forbid

The **gvrp vlan-creation-forbid** interface configuration command enables or disables dynamic VLAN creation. To disable dynamic VLAN creation, use the **no** form of this command.

Syntax

gvrp vlan-creation-forbid

no gvrp vlan-creation-forbid

Default Configuration

By default, dynamic VLAN creation is enabled.

Command Mode

Interface Configuration (Ethernet, port-channel) mode

User Guidelines

This command forbids dynamic VLAN creation from the interface. The creation or modification of dynamic VLAN registration entries as a result of the GVRP exchanges on an interface are restricted only to those VLANs for which static VLAN registration exists.

Example

The following example disables dynamic VLAN creation on port e8.

```
Console (config)# interface ethernet e8
Console (config-if)# gvrp vlan-creation-forbid
```

5.8.5 gvrp registration-forbid

The **gvrp registration-forbid** interface configuration command de-registers all dynamic VLANs, and prevents dynamic VLAN registration on the port. To allow dynamic registering for VLANs on a port, use the **no** form of this command.

Syntax

gvrp registration-forbid

no gvrp registration-forbid

Default Configuration

Dynamic registering and deregistering for each VLAN on the port is allowed.

Command Mode

Interface Configuration (Ethernet, port-channel) mode

User Guidelines

There are no user guidelines for this command.

Example

The following example shows how default dynamic registering and deregistering is forbidden for each VLAN on port e8.

```
Console (config)# interface ethernet e8
Console (config-if)# gvrp registration-forbid
```

5.8.7 clear gvrp statistics

The **clear gvrp statistics** privileged EXEC command clears all the GVRP statistics information.

Syntax

clear gvrp statistics [**ethernet** *interface* | **port-channel** *port-channel-number*]

- *interface* — A valid Ethernet interface.
- *port-channel-number* — A valid port-channel trunk index.

Default Configuration

This command has no default configuration.

Command Mode

Privileged EXEC mode

User Guidelines

There are no user guidelines for this command.

Example

The following example clears all the GVRP statistics information on port e8.

```
Console# clear gvrp statistics ethernet e8
```

5.8.8 show gvrp configuration

The **show gvrp configuration** User EXEC command displays GVRP configuration information, including timer values, whether GVRP and dynamic VLAN creation is enabled, and which ports are running GVRP.

Syntax

show gvrp configuration [**ethernet** *interface* | **port-channel** *port-channel-number*]

- *interface* — A valid Ethernet interface.
- *port-channel-number* — A valid port-channel trunk index.

Default Configuration

This command has no default configuration.

Command Mode

User EXEC mode

User Guidelines

There are no user guidelines for this command.

Example

The following example shows how to display GVRP configuration information:

```
Console# show gvrp configuration
```

```
GVRP Feature is currently enabled on the switch.
```

```
Maximum VLANs: 255,
```

| Port(s) | GVRP Status | Registration | Dynamic VLAN | Timers (milliseconds) Creation | Leave Join | Leave All |
|---------|----------------|--------------|-----------------|--------------------------------------|---------------|--------------|
| e1 | Enabled | Normal | Enabled | 200 | 600 | 10000 |
| e4 | Enabled | Normal | Enabled | 200 | 600 | 10000 |

5.8.9 show gvrp statistics

The **show gvrp statistics** User EXEC command displays GVRP statistics.

Syntax

show gvrp statistics [*ethernet interface* | **port-channel** *port-channel-number*]

- *interface* — A valid Ethernet interface.
- *port-channel-number* — A valid trunk index.

Default Configuration

This command has no default configuration.

Command Mode

User EXEC mode

User Guidelines

There are no user guidelines for this command.

Example

The following example shows GVRP statistics information:

```

Console# show gvrp statistics

GVRP statistics:
-----
rJE : Join Empty Received          rJIn : Join In Received
rEmp : Empty Received             rLIn : Leave In Received
rLE : Leave Empty Received        rLA : Leave All Received
sJE : Join Empty Sent             sJIn : Join In Sent
sEmp : Empty Sent                 sLIn : Leave In Sent
sLE : Leave Empty Sent            sLA : Leave All Sent

Port  rJE  rJIn  rEmp  rLIn  rLE  rLA  sJE  sJIn  sEmp  sLIn  sLE  sLA
-----
e1    0    0    0    0    0    0    0    0    0    0    0    0
e2    0    0    0    0    0    0    0    0    0    0    0    0
e3    0    0    0    0    0    0    0    0    0    0    0    0
e4    0    0    0    0    0    0    0    0    0    0    0    0
e5    0    0    0    0    0    0    0    0    0    0    0    0
e6    0    0    0    0    0    0    0    0    0    0    0    0

```

| | | | | | | | | | | | | |
|----|---|---|---|---|---|---|---|---|---|---|---|---|
| e7 | 0 | 0 | 0 | 0 | 0 | 0 | 0 | 0 | 0 | 0 | 0 | 0 |
| e8 | 0 | 0 | 0 | 0 | 0 | 0 | 0 | 0 | 0 | 0 | 0 | 0 |

5.8.10 show gvrp error-statistics

The **show gvrp error-statistics** user EXEC command displays GVRP error statistics.

Syntax

show gvrp error-statistics [*ethernet interface* | **port-channel** *port-channel-number*]

- *interface* — Valid Ethernet interface.
- *port-channel-number* — A valid port-channel trunk index.

Default Configuration

This command has no default configuration.

Command Mode

User EXEC mode

User Guidelines

There are no user guidelines for this command.

Example

The following example displays GVRP statistics information.

```

Console# show gvrp-error statistics

GVRP error statistics:
-----

Legend:
INVPROT : Invalid Protocol Id           INVPLEN : Invalid PDU Length
INVATYP : Invalid Attribute Type        INVALEN : Invalid Attribute Length
INVAVAL : Invalid Attribute Value       INVEVENT : Invalid Event
Port      INVPROT   INVATYP   INVAVAL   INVALEN   INVEVENT
-----
e1         0         0         0         0         0
e2         0         0         0         0         0
e3         0         0         0         0         0
e4         0         0         0         0         0
e5         0         0         0         0         0
e6         0         0         0         0         0
e7         0         0         0         0         0

```

| | | | | | |
|----|---|---|---|---|---|
| e8 | 0 | 0 | 0 | 0 | 0 |
|----|---|---|---|---|---|

5.9 IGMP Snooping Commands

5.9.1 ip igmp snooping (Global)

The **ip igmp snooping** global configuration command enables Internet Group Management Protocol (IGMP) snooping. To disable IGMP snooping use the **no** form of this command.

Syntax

ip igmp snooping

no ip igmp snooping

Default Configuration

IGMP snooping is disabled.

Command Mode

Global Configuration mode

User Guidelines

There are no user guidelines for this command.

Example

The following example enables IGMP snooping.

```
Console (config)# ip igmp snooping
```

5.9.2 ip igmp snooping (Interface)

The **ip igmp snooping** interface configuration command enables Internet Group Management Protocol (IGMP) snooping on a specific VLAN. To disable IGMP snooping on a VLAN interface, use the **no** form of this command.

Syntax

ip igmp snooping

no ip igmp snooping

Default Configuration

IGMP snooping is disabled on all VLANs in the set context.

Command Mode

Interface configuration (VLAN) mode

User Guidelines

IGMP snooping can only be enabled on static VLANs.

Example

The following example enables IGMP snooping on VLAN 2.

```
Console (config)# interface vlan 2
Console (config-if)# ip igmp snooping
```

5.9.3 ip igmp snooping mrouter

The **ip igmp snooping mrouter** interface configuration command enables automatic learning of multicast router ports in the context of a specific VLAN. To remove automatic learning of multicast router ports, use the **no** form of this command.

Syntax

ip igmp snooping mrouter learn-pim-dvmrp

no ip igmp snooping mrouter learn-pim-dvmrp

Default Configuration

Automatic learning of mrouter ports is enabled.

Command Mode

Interface Configuration (VLAN) mode

User Guidelines

Multicast router ports can be configured statically by the **bridge multicast forward-all** command.

Example

The following example enables automatic learning of multicast router ports on VLANs.

```
Console (config) # interface vlan 2
Console (config-if)# ip igmp snooping mrouter learn-pim-dvmrp
```

5.9.4 ip igmp snooping host-time-out

The **ip igmp snooping host-time-out** interface configuration command configures the host-time-out. If an IGMP report for a multicast group was not received for a host-time-out period, from a specific port, this port is deleted from the member list of that multicast group. To reset to default host-time-out use the **no** form of this command.

Syntax

ip igmp snooping host-time-out *time-out*

no ip igmp snooping host-time-out

Default Configuration

The default host-time-out is 260 seconds.

Command Mode

Interface Configuration (VLAN) mode

User Guidelines

The timeout should be at least greater than $2 * \text{query_interval} + \text{max_response_time}$ of the IGMP router.

Example

The following example configures the host timeout to 300 seconds.

```
Console (config)# interface vlan 2
Console (config-if)# ip igmp snooping host-time-out 300
```

5.9.5 ip igmp snooping mrouter-time-out

The **ip igmp snooping mrouter-time-out** interface configuration command configures the mrouter-time-out. The **mrouter-time-out** command is used for setting the aging-out time after multicast router ports are automatically learned. To configure the default mrouter-time-out, use the **no** form of this command.

Syntax

ip igmp snooping mrouter-time-out *time-out*

no ip igmp snooping mrouter-time-out

- *time-out*—mrouter timeout in seconds (Range: 1 - 2147483647)

Default Configuration

The default value is 300 seconds.

Command Mode

Interface Configuration (VLAN) mode

User Guidelines

There are no user guidelines for this command.

Example

The following example configures the mrouter timeout to 200 seconds.

```
Console (config)# interface vlan 2
Console (config-if)# ip igmp snooping mrouter-time-out 200
```

5.9.6 ip igmp snooping leave-time-out

The **ip igmp snooping leave-time-out** command configures the leave-time-out. If an IGMP report for a multicast group is not received within the leave-time-out period after an IGMP leave was received from a specific port, the current port is deleted from the member list of that multicast group. To configure the default leave-time-out, use the **no** form of this command.

Syntax

ip igmp snooping leave-time-out {*time-out* | *immediate-leave*}

no ip igmp snooping leave-time-out

- *time-out* — leave-time-out in seconds. (Range: 0 - 2147483647)
- *immediate-leave* — Specifies that the port should be immediately removed from the members list after receiving IGMP Leave.

Default Configuration

The default leave-time-out configuration is 10 seconds.

Command Mode

Interface Configuration (VLAN) mode

User Guidelines

The leave timeout should be set greater than the maximum time that a host is allowed to respond to an IGMP Query.

Use **immediate leave** only where there is only one host connected to a port.

Example

The following example configures the host leave-time-out to 60 seconds.

```
Console (config)# interface vlan 2
Console (config-if)# ip igmp snooping leave-time-out 60
```

5.9.7 show ip igmp snooping mrouter

The **show ip igmp snooping mrouter** User EXEC command displays information on dynamically learned multicast router interfaces.

Syntax

show ip igmp snooping mrouter [interface *vlan-id*]

- *vlan_id* — VLAN ID value.

Default Configuration

This command has no default configuration.

Command Mode

User EXEC mode

User Guidelines

There are no user guidelines for this command.

Example

The following example shows IGMP snooping mrouter information.

```

Console # show ip igmp snooping mrouter

VLAN          Ports
-----
2             e1

```

5.9.8 show ip igmp snooping interface

The **show ip igmp snooping interface** User EXEC command displays IGMP snooping configuration.

Syntax

show ip igmp snooping interface *vlan-id*

- *vlan_id* — VLAN ID value.

Default Configuration

This command has no default configuration.

Command Mode

User EXEC mode

User Guidelines

There are no user guidelines for this command.

Example

The example displays IGMP snooping information.

```

Console # show ip igmp snooping interface 1
IGMP Snooping is globally disabled

```

```

IGMP Snooping is disabled on VLAN 1
IGMP host timeout is 260 sec
IGMP Immediate leave is disabled. IGMP leave timeout is 60 sec
IGMP mrouter timeout is 300 sec
Automatic learning of multicast router ports is enabled

```

5.9.9 show ip igmp snooping groups

The **show ip igmp snooping groups** user EXEC command displays the multicast groups learned by IGMP snooping.

Syntax

show ip igmp snooping groups [**vlan** *vlan-id*] [**address** *ip-multicast-address*]

- *vlan_id* — VLAN ID value.
- *ip-multicast-address* — IP multicast address.

Default Configuration

This command has no default configuration.

Command Mode

User EXEC mode

User Guidelines

To see the full multicast address table (including static addresses) use the **show bridge address-table** command.

Example

The example shows IGMP snooping information.

```

Console # show ip igmp snooping groups

Vlan      IP Address          Querier      Ports
-----  -
1         224-239.130|2.2.3   Yes         e1, g2
19        224-239.130|2.2.8   Yes         e5-8

```

5.10 IP Addressing Commands

5.10.1 ip address

The **ip address** interface configuration command sets an IP address. To remove an IP address, use the **no** form of this command.

Syntax

ip address *ip-address* {*mask* | *prefix-length*}

no ip address [*ip-address*]

- *ip-address* — IP address
- *mask* — The IP address network mask. The IP address network mask 255.0.0.0 (prefix length 8) to 255.255.255.252 (prefix length 30)
- *prefix-length* — The number of bits that comprise the IP address prefix. The prefix length must be preceded by a forward slash (/). (Range: 8 -30)

Default Configuration

No IP address is defined for interfaces.

Command Mode

Interface configuration (Ethernet, VLAN, port-channel, out-of-band Ethernet)

User Guidelines

An IP address cannot be configured for a range of interfaces (range context).

Example

The following example configures VLAN 1 with the IP address 131.108.1.27 and subnet mask 255.255.255.0.

```
Console (config)# interface vlan 1
Console (config-if)# ip address 131.108.1.27 255.255.255.0
```

5.10.2 ip address dhcp

The **ip address dhcp** interface configuration command acquires an IP address on an interface from the Dynamic Host Configuration Protocol (DHCP) server. To deconfigure any acquired address, use the **no** form of this command.

The **no ip address dhcp** command deconfigures any IP address that was acquired, thus sending a DHCPRELEASE message.

Syntax

ip address dhcp [*hostname* *host-name*]

no ip address dhcp

- **hostname** — Specifies the host name.
- *host-name* — DHCP host name. This name need not be the same as the host name entered in global configuration

mode.

Default Configuration

This command has no default configuration.

Command Mode

Interface configuration (Ethernet, VLAN, port-channel, out-of-band Ethernet)

User Guidelines

The **ip address dhcp** command allows any interface to dynamically learn its IP address by using the DHCP protocol.

Some DHCP Servers require that the DHCPDISCOVER message have a specific host name. The most typical usage of the **ip address dhcp hostname *host-name*** command is when *host-name* is the host name provided by the system administrator.

If a router is configured to obtain its IP address from a DHCP server, it sends a DHCPDISCOVER message to provide information about itself to the DHCP server on the network.

If the **ip address dhcp** command is used with or without the optional keyword, the DHCP option 12 field (host name option) is included in the DISCOVER message. By default, the specified DHCP host name is the device globally configured host name.

When the device is reset, the DHCP command is saved in the configuration file, but the IP address is not. It is recommended not to define a DHCP address on an inband port or LAG. If a DHCP IP address is configured, this address is dynamically retrieved, and the "ip address dhcp" command is saved in the configuration file. In the event of a master failure, the backup will again attempt to retrieve a DHCP address. This could result in one of the following:

- The same IP address may be assigned;
- A different IP address may be assigned, which could result in loss of connectivity to the management station;
- The DHCP server may be down, which would result in IP address retrieval failure, and possible loss of connectivity to the management station.

Example

The following example acquires an IP address from DHCP.

```
Console (config)# interface vlan 1
Console (config-if)# ip address dhcp
```

5.10.3 ip default-gateway

The **ip default-gateway** command defines a default gateway (router). To remove the default gateway use the **no** form of this command.

Syntax

ip default-gateway ip-address

no ip default-gateway

- *ip-address* — Valid IP address that specifies the IP address of the default gateway.

Default Configuration

No default gateway is defined.

Command Mode

Interface configuration

User Guidelines

The setting of the default gateway on the out-of-band port must not precede the assignment of the IP address.

Always assign the IP address to the out-of-band port first, and then set the default gateway.

Example

The following example defines an ip default gateway.

```
Console(config)# ip default-gateway 192.168.1.1
```

5.10.4 show ip interface

The **show ip interface** user EXEC command displays the usability status of interfaces configured for IP.

Syntax

show ip interface [**ethernet** *interface-number* | **vlan** *vlan-id* | **port-channel** *number*]

- **ethernet** *interface-number* — Ethernet port number.
- **vlan** *vlan-id* — VLAN number.
- **port-channel** *number* — Port-channel number.

Default Configuration

This command has no default configuration.

Command Mode

User EXEC mode

User Guidelines

There are no user guidelines for this command.

Example

The following example displays VLAN 1 configuration.

```
Console# show ip interface vlan 1
```

5.10.5 arp

The **arp** global configuration command adds a permanent entry in the Address Resolution Protocol (ARP) cache.

To remove an entry from the ARP cache, use the **no** form of this command.

Syntax

```
arp ip_addr hw_addr {ethernet interface-number | vlan vlan-id | port-channel number | }
```

```
no arp ip_addr hw_addr {ethernet interface-number | vlan vlan-id | port-channel number | }
```

- *ip_addr* — IP address or IP alias to map to the specified MAC address.
- *hw_addr* — MAC address to map to the specified IP address or IP alias.
- **ethernet** *interface-number* — Ethernet port number.
- **vlan** *vlan-id* — VLAN number.
- **port-channel** *number* — Port-channel number.

Default Configuration

By default, ARP is disabled.

Command Mode

Global Configuration mode

User Guidelines

The software uses ARP cache entries to translate 32-bit IP addresses into 48-bit hardware addresses. Because most hosts support dynamic resolution, static ARP cache entries do not need to be specified.

Example

The following example adds the IP address 198.133.219.232 and MAC address 00-00-0c-40-0f-bc to the ARP table.

```
Console (config)# arp 198.133.219.232 0000.0c40.0fbc ethernet e8
```

5.10.6 arp timeout

The **arp timeout** global configuration command configures how long an entry remains in the ARP cache. To restore the default value, use the **no** form of this command.

Syntax

```
arp timeout seconds
```

```
no arp timeout seconds
```

- *seconds* — Time (in seconds) that an entry remains in the ARP cache. (Range: 1 - 4000000)

Default Configuration

The default timeout is 60000 seconds.

Command Mode

Global Configuration mode

User Guidelines

It is recommended not to set the timeout value to less than 3600.

Note:

The ARP entry is deleted between the period of the "timeout value" and twice the "timeout value". For example, if the timeout value is 20 seconds, the ARP value is deleted during the period of 20 to 40 seconds.

Example

The following example configures ARP timeout to 12000 seconds.

```
Console (config)# arp timeout 12000
```

5.10.7 clear arp-cache

The **clear arp-cache** privileged EXEC command deletes all dynamic entries from the ARP cache.

Syntax

```
clear arp-cache
```

Default Configuration

This command has no default configuration.

Command Mode

Privileged EXEC mode

User Guidelines

There are no user guidelines for this command.

Example

The following example deletes all dynamic entries from the ARP cache.

```
Console# clear arp-cache
```

5.10.8 show arp

The **show arp** privileged EXEC command displays entries in the ARP table.

Syntax

show arp

Default Configuration

This command has no default configuration.

Command Mode

Privileged EXEC mode

User Guidelines

There are no user guidelines for this command.

Example

The following example displays entries in the ARP table.

```

Console# show arp
ARP timeout: 60000 Seconds

Interface      IP address      HW address      status
-----
e1             10.7.1.102     00:10:B5:04:DB:4B  Dynamic
g2             10.7.1.135     00:50:22:00:2A:A4  Static

```

5.11 LACP Commands

5.11.1 lacp system-priority

The **lacp system-priority** global configuration command configures the system priority. To reset to default, use the **no** form of this command.

Syntax

lacp system-priority *value*

no lacp system-priority

- *value* — Value of the priority. (Range: 1 - 65535)

Default Configuration

The default system priority value is 1.

Command Mode

Global Configuration mode

User Guidelines

There are no user guidelines for this command.

Example

The following example configures the system priority to 120.

```
Console (config)# lacp system-priority 120
```

5.11.2 lacp port-priority

The **lacp port-priority** interface configuration command configures the priority value for physical ports. To reset to default priority value, use the **no** form of this command.

Syntax

lacp port-priority *value*

no lacp port-priority

- *value* — Port priority value. (Range: 1 - 65535)

Default Configuration

The default port priority value is 1.

Command Mode

Interface Configuration (Ethernet) mode

User Guidelines

There are no user guidelines for this command.

Example

The following example configures the priority value for port e8 to 247.

```
Console (config)# interface ethernet e8  
Console (config-if)# lacp port-priority 247
```

5.11.3 lacp timeout

The **lacp timeout** interface configuration command assigns an administrative LACP timeout. To reset the default administrative LACP timeout use the **no** form of this command.

Syntax

lacp timeout {long | short}

no lacp timeout

- **long** — Specifies a long timeout value.
- **Short** — Specifies a short timeout value.

Default Configuration

The default port timeout value is **long**.

Command Mode

Interface Configuration (Ethernet) mode

User Guidelines

There are no user guidelines for this command.

Example

The following example assigns an administrative LACP timeout for port e8 to a long timeout value.

```
Console (config)# interface ethernet e8
Console (config-if)# lacp timeout long
```

5.11.4 show lacp ethernet

The **show lacp ethernet** privilege EXEC command displays LACP information for Ethernet ports.

Syntax

show lacp ethernet *interface* [parameters | statistics | protocol-state]

- *Interface* — Ethernet interface.

Default Configuration

This command has no default configuration.

Command Mode

Privilege EXEC mode

User Guidelines

There are no user guidelines for this command.

Example

The following example shows how to display LACP statistics information.

```
Console# show lacp ethernet e1 statistics
```

```
Port e1 LACP Statistics:
```

```
LACP PDUs sent:2
```

```
LACP PDUs received:2
```

5.11.5 show lacp port-channel

The **show lacp port-channel** privileged EXEC command displays LACP information for a port-channel.

Syntax

```
show lacp port-channel [port_channel_number]
```

- *port_channel_number* — The port-channel number.

Default Configuration

This command has no default configuration.

Command Mode

Privileged EXEC mode

User Guidelines

There are no user guidelines for this command.

Example

The following example shows how to display LACP port-channel information.

```
Console# show lacp port-channel 1
Port-Channel 1:Port Type 1000 Ethernet

  Actor

      System Priority:1
      MAC Address: 000285:0E1C00
      Admin Key: 29
      Oper Key: 29

  Partner

      System Priority:0
      MAC Address: 000000:000000
      Oper Key: 14
```

5.12 Line Commands

5.12.1 line

The **line** global configuration command identifies a specific line for configuration and enters the line configuration command mode.

Syntax

line {console | telnet | ssh}

- **console** — Console terminal line.
- **telnet** — Virtual terminal for remote console access (Telnet).
- **ssh** — Virtual terminal for secured remote console access (SSH).

Default Configuration

This command has no default configuration.

Command Mode

Global Configuration mode

User Guidelines

There are no user guidelines for this command.

Examples

The following example configures the device as a virtual terminal for remote console access.

```
Console(config)# line telnet
Console(config-line)#
```

5.12.2 speed

The **speed** line configuration command sets the line baud rate.

Syntax

speed {bps}

- *bps* — Baud rate in bits per second (bps). The options are 2400, 9600, 19200 and 38400.

Default Configuration

This default speed is 115200.

Command Mode

Line Configuration (console) mode

User Guidelines

There are no user guidelines for this command, which is available only on the console line.

Examples

The following example the baud rate is set to 19200.

```
Console (config)# line console
Console(config-line)# speed 19200
```

5.12.3 exec-timeout

The **exec-timeout** line configuration command sets the interval that the system waits until user input is detected. To restore the default setting, use the **no** form of this command.

Syntax

exec-timeout *minutes* [*seconds*]

no exec-timeout

- *minutes* — Integer that specifies the number of minutes. (Range: 0 - 65535)
- *seconds* — Additional time intervals in seconds. (Range: 0 - 59)

Default Configuration

The default configuration is 10 minutes.

Command Mode

Line Configuration mode

User Guidelines

To specify no timeout, enter the **exec-timeout 0** command.

Examples

The following example configures the interval that the system waits until user input is detected to 20 minutes.

```
Console (config)# line console
Console(config-line)# exec-timeout 20
```

5.12.4 show line

The **show line** user EXEC command displays line parameters.

Syntax

show line [*console* | *telnet* | *ssh*]

- **console** — Console terminal line.
- **telnet** — Virtual terminal for remote console access (Telnet).
- **ssh** — Virtual terminal for secured remote console access (SSH).

Default Configuration

This command has no default configuration.

Command Mode

User EXEC mode

User Guidelines

There are no user guidelines for this command.

Examples

The following example displays the line configuration.

```
Console# show line

Console configuration:
Interactive timeout: 20
History: 10
Baudrate: 38400
Databits: 8
Parity: none
Stopbits: 1
Telnet configuration:
Interactive timeout: 10 minutes 10 seconds
History: 10

SSH configuration:
Interactive timeout: 10 minutes 10 seconds
History: 10
```

5.13 Management ACL Commands

5.13.1 management access-list

The **management access-list** configuration command defines an access-list for management, and enters the access-list for

configuration. Once in the access-list configuration mode, the denied or permitted access conditions are configured with the **deny** and **permit** commands. To remove an access list, use the **no** form of this command.

Syntax

management access-list *name*

no management access-list *name*

- *name* — The access list name using up to 32 characters.

Default Configuration

This command has no default configuration.

Command Mode

Global Configuration mode

User Guidelines

This command enters the access-list configuration mode, where the denied or permitted access conditions with the **deny** and **permit** commands must be defined.

If no match criteria are defined the default is "deny".

If reentering to an access-list context, the new rules are entered at the end of the access-list.

Use the **management access-class** command to select the active access-list.

The active management list cannot be updated or removed.

Examples

The following example shows how to create an access-list called "mlist", configure two management interfaces ethernet g1 and ethernet g9, and make the access-list the active list.

```
Console (config)# management access-list mlist
Console (config-macl)# permit ethernet g1
Console (config-macl)# permit ethernet g2
Console (config-macl)# exit
Console (config)# management access-class mlist
```

The following example shows how to create an access-list called "mlist", configure all interfaces to be management interfaces except interfaces ethernet g1 and ethernet g9, and make the access-list the active list.

```
Console (config)# management access-list mlist
Console (config-macl)# deny ethernet g1
Console (config-macl)# deny ethernet g2
Console (config-macl)# permit
Console (config-macl)# exit
Console (config)# management access-class mlist
```

5.13.2 permit (management)

The **permit** management access-list configuration command defines a permit rule.

Syntax

permit [**ethernet** *interface-number* | **vlan** *vlan-id* | **port-channel** *number* | **out-of-band-eth** *oob-interface*] [**service** *service*]

permit ip-source *ip-address* [**mask** *mask* | *prefix-length*] [**ethernet** *interface-number* | **vlan** *vlan-id* | **port-channel** *number* | **out-of-band-eth** *oob-interface*] [**service** *service*]

- **ethernet** *interface-number* — A valid Ethernet port number.
- **vlan** *vlan-id* — A valid VLAN number.
- **port-channel** *number* — A valid port channel number.
- *ip-address* — Source IP address.(Range: Valid IP Address)
- **mask** *mask* — Specifies the network mask of the source IP address. (Range: Valid subnet mask)
- **mask** *prefix-length* — Specifies the number of bits that comprise the source IP address prefix. The prefix length must be preceded by a forward slash (/). (Range: 0 - 32)
- **service** *service* — Indicates service type. Can be one of the following: **telnet**, **ssh**, **http**, **https** or **snmp**.
- **out-of-band-eth** *oob-interface* — Out of band ethernet port number.

Default Configuration

This command has no default configuration.

Command Mode

Management Access-list Configuration mode

User Guidelines

Rules with Ethernet, VLAN and port-channel parameters are valid only if an IP address is defined on the appropriate interface.The system supports up to 256 management access rules.

Example

The following example shows how all ports are permitted in the access-list called "mlist".

```
Console (config)# management access-list mlist
Console (config-macl)# permit
```

5.13.3 deny (management)

The **deny** management access-list configuration command defines a deny rule.

Syntax

deny [**ethernet** *interface-number* | **vlan** *vlan-id* | **port-channel** *number*] [**service** *service*]

deny ip-source *ip-address* [**mask** *mask* | *prefix-length*] [**ethernet** *interface-number* | **vlan** *vlan-id* | **port-channel** *number* | **out-of-band-eth** *oob-interface*] [**service** *service*]

- **ethernet** *interface-number* — A valid Ethernet port number.
- **vlan** *vlan-id* — A valid VLAN number.
- **port-channel** *number* — A valid port-channel number.
- *ip-address* — Source IP address. (Range: Valid IP Address)
- **mask** *mask* — Specifies the network mask of the source IP address.(Range: Valid subnet mask)
- **mask** *prefix-length* — Specifies the number of bits that comprise the source IP address prefix. The prefix length must be preceded by a forward slash (/).
- **service** *service* — Indicates service type. Can be one of the following: **telnet**, **ssh**, **http**, **https** or **snmp**.

Default Configuration

This command has no default configuration.

Command Mode

Management Access-list Configuration mode

User Guidelines

Rules with Ethernet, VLAN and port-channel parameters are valid only if an IP address is defined on the appropriate interface. The system supports up to 256 management access rules.

Example

The following example shows how all ports are denied in the access-list called "mlist".

```
Console (config)# management access-list mlist
Console (config-macl)# deny
```

5.13.4 management access-class

The **management access-class** global configuration command defines which management access-list is used. To disable restriction, use the **no** form of this command.

Syntax

management access-class {**console-only** | *name*}

no management access-class

- *name* — Name of the access list. If unspecified, defaults to an empty access-list.(Range: Valid name)
- **console-only** — The device can be managed only from the console.

Default Configuration

This command has no default configuration.

Command Mode

Global Configuration mode

User Guidelines

There are no user guidelines for this command.

Example

The following example configures an access-list called "mlist" as the management access-list.

```
Console (config)# management access-class mlist
```

5.13.5 show management access-list

The **show management access-list** privileged EXEC command displays management access-lists.

Syntax

show management access-list [*name*]

- *name* — Name of the access list. If unspecified, defaults to an empty access-list. (Range: Valid name)

Default Configuration

This command has no default configuration.

Command Mode

Privileged EXEC mode

User Guidelines

There are no user guidelines for this command.

Example

The following example displays the active management access-list.

```
Console# show management access-list

mlist
-----
permit ethernet g1

permit ethernet g9

! (Note: all other access implicitly denied)
```

5.13.6 show management access-class

The **show management access-class** privileged EXEC command displays the active management access-list.

Syntax

show management access-class

Default Configuration

This command has no default configuration.

Command Mode

Privileged EXEC mode

User Guidelines

There are no user guidelines for this command.

Example

The following example displays the management access-list information.

```
Console# show management access-class
Management access-class is enabled, using access list mlist
```

5.14 PHY Diagnostics Commands

5.14.1 test copper-port tdr

The **test copper-port tdr** privileged EXEC command diagnoses with TDR (Time Domain Reflectometry) technology the quality and characteristics of a copper cable attached to a port.

Syntax

test copper-port tdr *interface*

- *interface* — A valid Ethernet port.

Default Configuration

This command has no default configuration.

Command Mode

Privileged EXEC mode

User Guidelines

The port can only be tested if cable is connected to both sides.

The port under test should be shut down during the test, unless it is a combo port with an active fiber port.

The maximum distance VCT can function is 120 meters.

Examples

The following example results in a report on the cable attached to port e3.

```
Console# test copper-port tdr e3
Cable is open at 100 meters
```

The following example results in a failure to report on the cable attached to port e4.

```
Console# test copper-port tdr e4
Can't perform the test on fiber ports
```

5.14.2 show copper-ports tdr

The **show copper-ports tdr** privileged EXEC command displays the last TDR (Time Domain Reflectometry) tests on specified ports.

Syntax

show copper-ports tdr [*interface*]

- *interface* — A valid Ethernet port.

Default Configuration

This command has no default configuration.

Command Mode

Privileged EXEC mode

User Guidelines

There are no user guidelines for this command.

Example

The following example displays the last TDR (Time Domain Reflectometry) tests on all ports.

```
Console# show copper-ports tdr
```

| Port | Result | Length [meters] | Date |
|-------|-----------------------------|--------------------|-----------------------|
| ----- | ----- | ----- | ----- |
| e1 | OK | | |
| e2 | Short | 50 | 13:32:00 23 July 2003 |
| e3 | Test has not been performed | | |
| e4 | Short | 128 | 13:32:00 23 July 2003 |

| | | | |
|----|-------|---|---|
| e5 | Fiber | - | - |
|----|-------|---|---|

5.14.3 show copper-ports cable-length

The **show copper-ports cable-length** privileged EXEC command displays the estimated copper cable length attached to a port.

Syntax

show copper-ports cable-length [*interface*]

- *interface* — A valid Ethernet port.

Default Configuration

This command has no default configuration.

Command Mode

Privileged EXEC mode

User Guidelines

This feature works only on 1-Gbps ports.

Example

The following example displays the estimated copper cable length attached to all ports.

```

Console# show copper-ports cable-length

Port          Length [meters]
-----
e1             < 50
e2             Giga link not active
e3             110-140
e4             Fiber

```

5.14.4 show fiber-ports optical-transceiver

The **show fiber-ports optical-transceiver** privileged EXEC command displays the optical transceiver diagnostics.

Syntax

show fiber-ports optical-transceiver [*interface*] [**detailed**]

- *interface* — A valid Ethernet port.

- **Detailed** — Detailed diagnostics.

Default Configuration

This command has no default configuration.

Command Mode

Privileged EXEC mode

User Guidelines

To test optical transceivers ensure a fiber link is present.

Examples

The following example displays the optical transceiver diagnostics.

```

console# show fiber-ports optical-transceiver

Port      Temp      Voltage    Current    Output    Input    LOS
          [W]      [V]        [mA]      [Power]   [Power]  [Power]
-----
g1         W         OK         E          OK        OK        OK
g2         OK        OK         OK         OK        OK        OK
e3         Copper

Temp – Internally measured transceiver temperature.

Voltage - Internally measured supply voltage.

Current – Measured TX bias current.

Output Power – Measured TX output power.

Input Power – Measured RX received power.

Tx Fault – Transmitter fault

LOS – Loss of signal

Data ready – Indicates transceiver has achieved power up and data is ready.

N/A - Not Available, N/S - Not Supported, W - Warning, E - Error
    
```

The following example displays detailed optical transceiver diagnostics

```

console# show fiber-ports transceiver detailed

Port      Temp      Voltage    Current    Output    Input    LOS
          [C]      [Volt]    [mA]      [Power]   [Power]
-----
    
```

| | | | | [mWatt] | [mWatt] | |
|----|--------|--|------|---------|---------|----|
| e1 | 48 | | 5.15 | 50 | 1.789 | No |
| e2 | 43 | | 5.15 | 10 | 1.789 | No |
| e3 | Copper | | | | | |

Temp – Internally measured transceiver temperature.
Voltage - Internally measured supply voltage.
Current – Measured TX bias current.
Output Power – Measured TX output power.
Input Power – Measured RX received power.
Tx Fault – Transmitter fault
LOS – Loss of signal
Data ready – Indicates transceiver has achieved power up and data is ready.
N/A - Not Available, N/S - Not Supported, W - Warning, E - Error

5.15 Port Channel Commands

5.15.1 interface port-channel

The **interface port-channel** global configuration command enters the interface configuration mode of a specific port-channel.

Syntax

interface port-channel *port-channel-number*

- *port-channel-number* — A valid port-channel trunk index.

Default Configuration

This command has no default configuration.

Command Mode

Global Configuration mode

User Guidelines

Seven supported aggregated links are defined, and per port-channel, up to 4 member ports.

Turning off auto-negotiation of an aggregate link may, under some circumstances, make it non-operational. If the other side has auto-negotiation turned on, it may re-synchronize all members of the aggregated link to half-duplex operation, and may, as per

the standards, set them all to inactive.

Example

The following example enters the context of port-channel number 1.

```
Console (config)# interface port-channel 1
```

5.15.2 interface range port-channel

The **interface range port-channel** global configuration command enters the interface configuration mode to configure multiple port-channels.

Syntax

interface range port-channel {*port-channel-range* | **all**}

- *port-channel-range* — List of port-channels to configure. Separate non-consecutive port-channels with a comma and no spaces. A hyphen designates a range of port-channels.
- **all** — All the channel-ports.

Default Configuration

This command has no default configuration.

Command Mode

Global Configuration mode

User Guidelines

Commands under the interface range context are executed independently on each interface in the range. If the command returns an error on one of the interfaces, it stops the execution of the command on subsequent interfaces.

Example

The following example shows how port-channels 1, 2 and 8 are grouped to receive the same command.

```
Console (config)# interface range port-channel 1-2
Console (config-if)#
```

5.15.3 channel-group

The **channel-group** interface configuration command associates a port with a port-channel. To remove a port from a port channel, use the **no** form of this command.

Syntax

channel-group *port-channel-number* **mode** {**on** | **auto**}

no channel-group

- *port-channel_number* — Specifies the number of the valid port-channel for the current port to join.
- **on** — Forces the port to join a channel.
- **auto** — Allows the port to join a channel as a result of an LACP operation.

Default Configuration

The port is not assigned to any port-channel.

Command Mode

Interface Configuration (Ethernet) mode

User Guidelines

Turning off auto-negotiation on an aggregate link may, under some circumstances make it non operational. If the other side has auto-negotiation turned on, it may re-synchronize all members of the aggregated link to half-duplex operation, and may, as per the standard, set them all to Inactive.

When a port is added to a LAG, it acquires the trunk properties, as set by the administrator. If the port cannot be configured accordingly, it will not be added to the LAG, and the user will get an appropriate error message. However, if the first port to join the LAG is one which cannot be configured according to the administrative settings of the LAG, the port will nonetheless be added to the LAG, using its port-default settings. An error message is generated; however, it is important to note that, since it is then the ONLY port of the LAG, the whole LAG at that point operates at the port's settings, instead of the LAG administrative settings.

Example

The following example shows how port e5 is configured to port-channel number 1 without LACP.

```
Console (config)# interface ethernet e5
Console (config-if)# channel-group 1 mode on
```

5.15.4 show interfaces port-channel

The **show interfaces port-channel** user EXEC command displays port-channel information (which ports are members of that port-channel, and whether they are currently active or not).

Syntax

show interfaces port-channel [*port-channel-number*]

- *port-channel-number* — Valid port-channel number information to display.

Default Configuration

This command has no default configuration.

Command Mode

User EXEC mode

User Guidelines

There are no user guidelines for this command.

Example

The following example shows how all port-channel information is displayed.

```

Console (config)# show interfaces port-channel

Channel                Ports
-----                -
ch1                    Active: g2
ch2                    Active: e3, e7 Inactive: g1
ch3                    Active: e4, e8

```

5.16 Port Monitor Commands

5.16.1 port monitor

The **port monitor** interface configuration command starts a port monitoring session. To stop a port monitoring session, use the **no** form of this command.

Syntax

port monitor *src-interface* [**rx** | **tx**]

no port monitor *src-interface*

- *src-interface* — Valid Ethernet port or port-channel number.
- **rx** — Monitors received packets only. If no option specified, monitors both rx and tx.
- **tx** — Monitors transmitted packets only. If no option specified, monitors both rx and tx.

Default Configuration

This command has no default configuration.

Command Mode

Interface Configuration mode

User Guidelines

This command enables traffic on one port to be copied to another port, or between the source port (*src-interface*) and a destination port (the port being configured). Only a single target port can be defined per system.

The port being monitored cannot be set faster than the monitoring port.

The following restrictions apply to ports configured to be destination ports:

The port cannot be already configured as a source port.

The port cannot be a member in a port-channel.

An IP interface is not configured on the port.

GVRP is not enabled on the port.

The port is not a member in any VLAN, except for the default VLAN (will automatically be removed from the default VLAN).

The following restrictions apply to ports configured to be source ports:

Port monitoring Source Ports must be simple ports, and not port-channels.

The port cannot be already configured as a destination port.

All the frames are transmitted as either always tagged or always untagged. Refer to the **port-monitor vlan-tagging** command below.

General Restrictions:

Ports cannot be configured as a group using the **interface range ethernet** command.

Note:

The Port Mirroring target must be a member of the Ingress VLAN of all Mirroring source ports. Therefore, multicast and broadcast frames in these VLANs are seen more than once. (Actually N, where N is the number of mirroring source ports).

When both transmit (Tx) and receive (Rx) directions of more than one port are monitored, the capacity may exceed the bandwidth of the target port. In this case, the division of the monitored packets may not be equal. The user is advised to use caution in assigning port monitoring.

Example

The following example shows how traffic on port e8 (source port) is copied to port g1 (destination port).

```
Console(config)# interface ethernet g1
Console(config-if)# port monitor e8
```

5.16.2 show ports monitor

The **show ports monitor** user EXEC command displays the port monitoring status.

Syntax

show ports monitor

Default Configuration

This command has no default configuration.

Command Mode

User EXEC mode

User Guidelines

There are no user guidelines for this command.

Example

The following example shows how the port copy status is displayed.

```
Console#show ports monitor
```

| Source Port | Destination Port | Type | Status | VLAN Tagging |
|-------------|------------------|--------|--------|--------------|
| 1/1 | 1/8 | RX, TX | Active | No |
| 1/2 | 1/8 | RX, TX | Active | No |
| 1/18 | 1/8 | Rx | Active | No |

5.17 QoS Commands

5.17.1 qos

The **qos** global configuration command enables quality of service (QoS) on the device and enters QoS basic or advanced mode. Use the **no** form of this command to disable the QoS features on the device.

Syntax

qos [advanced]

no qos

- **advanced** — QoS advanced mode, which enables the full range of QoS configuration.

Default Configuration

By default QoS is enabled in basic mode.

Command Mode

Global Configuration mode

User Guidelines

There are no user guidelines for this command. However, switching to Basic qos mode sets the trust mode to cos.

Example

The following example shows how QoS is enabled on the device, in basic mode.

```
Console (config)# qos
```

5.17.2 show qos

The **show qos** user EXEC command displays the QoS status.

Syntax

show qos

Default Configuration

This command has no default configuration.

Command Mode

User EXEC mode

User Guidelines

There are no user guidelines for this command.

Example

The following example displays a device where basic mode is supported.

```

Console# show qos

Qos: basic

Basic trust: dscp

```

5.17.3 wrr-queue cos-map

The **wrr-queue cos-map** global configuration command maps assigned CoS values to select one of the egress queues. To return to the default values, use the **no** form of this command.

Syntax

wrr-queue cos-map *queue-id* *cos1...cosn*

no wrr-queue cos-map [*queue-id*]

- *queue-id* — The queue number to which the following CoS values are mapped.
- *cos1...cosn* — Map to specific queues up to eight CoS values from 0 to 7.

Default Configuration

The map default values are as follows:

```

CoS value 1 select queue 1
CoS value 2 select queue 2
CoS value 0 select queue 3
CoS value 3 select queue 4
CoS value 4 select queue 5
CoS value 5 select queue 6
CoS value 6 select queue 7
CoS value 7 select queue 8

```

Command Mode

Global Configuration mode

User Guidelines

You can use this command to distribute traffic into different queues, where each queue is configured with different weighted round robin (WRR) and Weighted Random Early Detection (WRED) parameters.

You enable the expedite queues by using the **priority-queue out** interface configuration command **wrr-queue cos-map**.

It is recommended to specifically map a single VPT to a queue, rather than mapping multiple VPTs to a single queue

Example

The following example maps CoS 3 to queue 7.

```

Console (config)# wrr-queue cos-map 7 3

```

5.17.4 wrr-queue bandwidth

The **wrr-queue bandwidth** interface configuration command assigns Weighted Round Robin (WRR) weights to egress queues. The weights ratio determines the frequency in which the packet scheduler dequeues packets from each queue. To return to the default values, use the **no** form of this command.

Syntax

wrr-queue bandwidth *weight1 weight2 ... weight_n*

no wrr-queue bandwidth

- *weight1...weight_n*—Sets the bandwidth ratio in which the WRR packet scheduler dequeues packets. Separate each value by spaces. (Range: 6 - 255)

Default Configuration

The default WRR weight is 1/8 ratio for all queues (each weight set to 6).

Command Mode

Interface Configuration mode

User Guidelines

The packet refers to a threshold by the conformance level. Weighted round robin queues should be defined on the interface.

Use the **priority-queue out num-of-queues** command to globally configure a queue as WRR or Strict Priority.

Use this command to set a weight per interface.

The ratio will be like this:

The ratio for each queue is defined by the queue weight divided by the sum of all queue weights (i.e., the normalized weight).

This actually sets the bandwidth allocation of each queue.

A weight of 0 means no bandwidth is allocated for the same queue, and the share bandwidth is divided among the remaining queues.

All eight queues are participating excluding the queues that are assigned as expedite queues. The weights of these queues are ignored in the ratio calculation.

All eight queues participate in the WRR exclude the expedite queues, in which case the corresponded weight is ignored (not used in the ratio calculation). The expedite queue is a priority queue, and it is serviced until empty before the other queues are serviced.

Use the **priority-queue out num-of-queues** command to globally configure a queue as WRR or Strict Priority.

Use this command to set a weight per interface.

Example

The following example sets queue weights as follows:

- Queue 1—6/36

- Queue 2—6/36
- Queue 3—6/36
- Queue 4—6/36
- Queue 5—6/36
- Queue 6—6/36
- Queue 7—6/36
- Queue 8—6/36

```
Console (config-if)# wrr-queue bandwidth 6 6 6 6 6 6 6 6
```

5.17.5 priority-queue out num-of-queues

The **priority-queue out num-of-queues** global configuration command enables the egress queues to be expedite queues. Use the **no** form of this command to return to the default values.

Syntax

priority-queue out num-of-queues *number-of-queues*

no priority-queue out num-of-queues

- *number-of-queues* — Assign the number of queues to be expedite queues. The expedite queues would be the queues with higher indexes. The range is 1 – 8.

Default Configuration

All queues are expedite queues.

Command Mode

Global Configuration mode

User Guidelines

When configuring the **priority-queue out num-of-queues** command, the weighted round robin (WRR) weight ratios are affected because there are fewer queues participating in WRR.

Example

The following example sets queue 7, 8 to be an EF queue.

```
Console (config)# priority-queue out num-of-queues 2
```

5.17.6 show qos interface

The **show qos interface** user EXEC command displays interface QoS data.

Syntax

show qos interface [**ethernet** *interface-number* | **vlan** *vlan-id* | **port-channel** *number*] [**buffers** | **queuing** | **policers** | **shapers**]

- **ethernet** *interface-number* — Ethernet port number.
- **vlan** *vlan-id* — VLAN number.
- **port-channel** *number* — Port-channel.
- **buffers** — Displays buffer setting for the interface queues. For gigabit Ethernet interfaces, the queue depth for each of the 8 queues and the thresholds for the WRED/Tail Drop are displayed. For 10/100 interfaces the minimum reserved settings are displayed.
- **queuing** — Displays the queue strategy (WRR or EF), the weight for WRR queues, the CoS to queue map and the EF priority.
- **shapers** — Displays the specified interface shaper and the shaper for the queue on the specified interface.
- **policers** — Displays all the policers configured for this interface, their setting, and the number of policers currently unused.

Default Configuration

For VLAN interface only the **policers** option is relevant.

If no keyword is specified with the **show qos interface** command, the port QoS mode, default CoS value, DSCPto-DSCP-mutation map (if any) attached to the port, and policy map (if any) attached to the interface are displayed. If a specific interface is not specified, the information for all interfaces is displayed.

Command Mode

User EXEC mode

User Guidelines

There are no user guidelines for this command.

Examples

The following example displays output from the **show qos interface ethernet e1 buffers** command.

```

Console# show qos interface ethernet e1 buffers
Ethernet e1
Notify Q depth:

qid  Size
1    125
2    125
3    125
4    125
5    125
6    125
7    125
8    125

qid                Threshold
1                   100
2                   100
3                   100

```

| | | | | | | | | | | |
|---|--|--|--|--|--|--|--|--|--|-----|
| 4 | | | | | | | | | | 100 |
| 5 | | | | | | | | | | N/A |
| 6 | | | | | | | | | | N/A |
| 7 | | | | | | | | | | N/A |
| 8 | | | | | | | | | | N/A |

| qid | MinDP0 | MaxDP0 | ProbDP0 | MinDP1 | MaxDP1 | ProbDP1 | MinDP2 | MaxDP2 | ProbDP2 | Weight |
|-----|--------|--------|---------|--------|--------|---------|--------|--------|---------|--------|
| 1 | N/A | N/A | N/A | N/A | N/A | N/A | N/A | N/A | N/A | N/A |
| 2 | N/A | N/A | N/A | N/A | N/A | N/A | N/A | N/A | N/A | N/A |
| 3 | N/A | N/A | N/A | N/A | N/A | N/A | N/A | N/A | N/A | N/A |
| 4 | N/A | N/A | N/A | N/A | N/A | N/A | N/A | N/A | N/A | N/A |
| 5 | 50 | 60 | 13 | 65 | 80 | 6 | 85 | 95 | 4 | 2 |
| 6 | 50 | 60 | 13 | 65 | 80 | 6 | 85 | 95 | 4 | 2 |
| 7 | 50 | 60 | 13 | 65 | 80 | 6 | 85 | 95 | 4 | 2 |
| 8 | 50 | 60 | 13 | 65 | 80 | 6 | 85 | 95 | 4 | 2 |

The following example displays output from the **show qos interface ethernet g1 queueing** command.

```

Console# show qos interface Ethernet g1 queueing
Ethernet g1
wrr bandwidth weights and EF priority:

```

| qid | weights | Ef | Priority |
|-----|---------|-----|----------|
| 1 | 125 | dis | N/A |
| 2 | 125 | dis | N/A |
| 3 | 125 | dis | N/A |
| 4 | 125 | dis | N/A |
| 5 | N/A | ena | 5 |
| 6 | 125 | dis | N/A |
| 7 | 125 | dis | N/A |
| 8 | N/A | ena | 8 |

```

Cos-queue map:
cos      qid
0        3
1        1
2        2
3        4
4        5
5        6
6        7
7        8

```

The following example displays output from the **show qos interface g1 shapers** command.

```

Console# show qos interface g1 shapers
Ethernet g1
Port shaper: enable
Committed rate: 192000 bps
Committed rate: 192000 bps
Committed burst: 9600 bytes

```

| qid | status | Target Committed Rate [bps] | Target Committed Burst [bytes] |
|-----|---------|-----------------------------|--------------------------------|
| 1 | Enable | 100000 | 17000 |
| 2 | Disable | N/A | N/A |
| 3 | Enable | 200000 | 19000 |
| 4 | Disable | N/A | N/A |
| 5 | Disable | N/A | N/A |

| | | | |
|---|---------|--------|------|
| 6 | Disable | N/A | N/A |
| 7 | Enable | 178000 | 8000 |
| 8 | Enable | 23000 | 1000 |

The following example displays output from the show qos interface g1 policers command

```

Console# show qos interface ethernet g1 policers
Ethernet g1
Class map: A
Policer type: aggregate
Committed rate: 192000 bps
Committed burst: 9600 bytes
Exceed-action: policed-dscp-transmit
Class map: B
Policer type: single
Committed rate: 192000 bps
Committed burst: 9600 bytes
Exceed-action: drop
Class map: C
Policer type: none
Committed rate: N/A
Committed burst: N/A
Exceed-action: N/A

```

5.17.7 qos map dscp-queue

The **qos map dscp-queue** global configuration command modifies the DSCP to queue map. To return to the default map, use the **no** form of this command.

Syntax

qos map dscp-queue *dscp-list to queue-id*

no qos map dscp-queue

- *dscp-list*—Specify up to 8 DSCP values, separate each DSCP with a space. (Range: 0 - 63)
- *queue-id*—Enter the queue number to which the DSCP value corresponds.

QoS Commands

qos trust (Global)

Copyright © 2004 Marvell **CONFIDENTIAL** Doc. No. MV-S200005-00 Rev. C

January 19, 2004, Preliminary

Document Classification: Proprietary Information Page 147

Default Configuration

The following table describes the default map.

Command Mode

Global Configuration mode

User Guidelines

Queue settings for 3, 11, 19, ... cannot be modified.

Example

The following example maps DSCP values 33, 40 and 41 to queue 1.

```
Console (config)# qos map dscp-queue 33 40 41 to 1
```

5.17.8 qos trust (Global)

The **qos trust** global configuration command can be used in basic mode to configure the system to "trust" state.

To return to the default state, use the **no** form of this command.

Syntax

```
qos trust {cos | dscp | tcp-udp-port}}
```

```
no qos trust
```

- **cos** — Classifies ingress packets with the packet CoS values. For untagged packets, the port default CoS is used.
- **dscp** — Classifies ingress packets with the packet DSCP values.
- **tcp-udp-port** — Classifies ingress packets with the packet destination port values.

Default Configuration

If the system is in basic mode then CoS is the default trust mode.

Command Mode

Global Configuration mode

User Guidelines

This command can be used only in QoS basic mode.

Packets entering a quality of service (QoS) domain are classified at the edge of the QoS domain. When the packets are classified at the edge, the switch port within the QoS domain can be configured to one of the trusted states because there is no need to classify the packets at every switch within the domain.

Use this command to specify whether the port is trusted and which fields of the packet to use to classify traffic.

DSCP value 0-7 8-15 16-23 24-31 32-39 40-47 48-56 57-63

Queue-ID 1 2 3 4 5 6 7 8

For an inter-QoS domain boundary, the port can be configured to the DSCP-trusted state and apply the DSCP-to-DSCP-mutation map, if the DSCP values are different between the QoS domains.

To return to the untrusted state, use the **no qos** command to apply best effort service.

Example

The following example configures the system in basic mode to DSCP trust state.

```
Console (config)# qos trust dscp
```

5.17.9 qos trust (Interface)

The **qos trust** interface configuration command enables each port trust state while the system is in basic mode.

To disable the trust state on each port, use the **no** form of this command.

Syntax

qos trust

no qos trust

Default Configuration

Each port is enabled while the system is in basic mode.

Command Mode

Interface Configuration (Ethernet, port-channel) mode

User Guidelines

Use **no qos trust** to disable the trust mode on each port.

Use **qos trust** to enable trust mode on each port.

Example

The following example configures port e5 in basic mode to default trust state (CoS).

```
Console (config)# interface ethernet e5
```

```
Console (config-if) qos trust
```

5.17.10 qos cos

The **qos cos** interface configuration command configures the default port CoS value. To return to the default setting, use the **no**

form of this command.

Syntax

qos cos *default-cos*

no qos cos

qos cos override

- *default-cos* — Specifies the default CoS value being assigned to the port. If the port is trusted and the packet is untagged then the default CoS value becomes the CoS value. (Range: 0 - 7)

Default Configuration

Port CoS is 0.

Command Mode

Interface Configuration (Ethernet, port-channel) command

User Guidelines

There are no user guidelines for this command.

Example

The following example configures port e5 default CoS value to 3.

```
Console (config)# interface ethernet e5
Console (config-if) qos cos 3
```

5.17.11 qos cos override

The **qos cos override** interface configuration command overrides the CoS of incoming packets. To disable the override, use the **no** form of this command.

Syntax

qos cos override

no qos cos override

This command has no arguments or keywords.

Default Configuration

CoS Override is disabled

Command Mode

Interface configuration (Ethernet, Port-Channel).

User Guidelines

This command enables to override the CoS value of tagged packets, with the value configured by the **qos cos** command.

Example

The following example overrides the CoS of incoming packets.

```
Console(config)# qos cos override
```

5.17.12 show qos map

The show qos map user EXEC command displays all the QoS maps.

Syntax

show qos map [dscp-queue / policed-dscp | dscp-mutation]

- **dscp-queue** — Displays the DSCP to queue map.
- **policed-dscp** — Displays the DSCP to DSCP remark table.
- **dscp-mutation** — Displays the DSCP-DSCP mutation table.

Default Configuration

This command has no default configuration.

Command Mode

User EXEC command

User Guidelines

There are no user guidelines for this command.

Example

The following example displays the DSCP port-queue map.

```
console# show qos map
Dscp-queue map:
d1 :      d2 0      1      2      3      4      5      6      7      8      9
----      ---      ---      ---      ---      ---      ---      ---      ---      ---
0 :      01      01      01      01      01      01      01      01      02      02
1 :      02      02      02      02      02      02      03      03      03      03
2 :      03      03      03      03      03      03      04      04      04      04
3 :      04      04      05      05      05      05      05      05      05      05
4 :      06      06      06      06      06      06      06      06      07      07
5 :      07      07      07      07      07      07      08      08      08      08
6 :      08      08      08      08
```

The following example displays the policed-DSCP map.

```

Policed-dscp map:
d1 :  d2 0    1    2    3    4    5    6    7    8    9
-----
0 :    00    01  02  03  04  05  06  07  08  09
1 :    10    11  12  13  14  15  16  17  18  19
2 :    20    21  22  23  24  25  26  27  28  29
3 :    30    31  32  33  34  35  36  37  38  39
4 :    40    41  42  43  44  45  46  47  48  49
5 :    50    51  52  53  54  55  56  57  58  59
6 :    60    61  62  63

```

The following example displays the DSCP-dscp mutation map.

```

Dscp-dscp mutation map:
d1 :  d2 0    1    2    3    4    5    6    7    8    9
-----
0 :    00    01  02  03  04  05  06  07  08  09
1 :    10    11  12  13  14  15  16  17  18  19
2 :    20    21  22  23  24  25  26  27  28  29
3 :    30    31  32  33  34  35  36  37  38  39
4 :    40    41  42  43  44  45  46  47  48  49
5 :    50    51  52  53  54  55  56  57  58  59
6 :    60    61  62  63

```

5.18 Radius Commands

5.18.1 radius-server host

The **radius-server host** global configuration command specifies a RADIUS server host. To delete the specified RADIUS host, use the **no** form of this command.

Syntax

```
radius-server host {ip-address} [auth-port auth-port-number] [timeout timeout] [retransmit retransmit] [deadtime deadtime]
```

[**key** *key*] [**source** *source*] [**priority** *priority*]

no radius-server host *ip-address*

- **ip-address** — IP address of the RADIUS server host. An out-of-band IP address can be specified as described in the usage guidelines.
- **timeout** — Specifies the timeout value in seconds. If no timeout value is specified, the global value is used. (Range: 1 - 30)
- **retransmit** — Specifies the re-transmit value. If no re-transmit value is specified, the global value is used. (Range: 1 -10)
- **deadtime** — Length of time, in minutes, for which a RADIUS server is skipped over by transaction requests. (Range 0 - 2000)
- **key** — Specifies the authentication and encryption key for all RADIUS communications between the router and the RADIUS server. This key must match the encryption used on the RADIUS daemon. If no key value is specified, the global value is used.
- **source** — Specifies the source IP address to use for the communication. If no retransmit value is specified, the global value is used. 0.0.0.0 is interpreted as request to use the IP address of the outgoing IP interface. An out-of-band IP address can be specified as described in the usage guidelines.
- **priority** — Determines the order in which the servers are used, where 0 is the highest priority (Range: 0 - 65535).

Default Configuration

By default, no RADIUS host is specified.

Command Mode

Global Configuration mode

User Guidelines

To specify multiple hosts, multiple **radius-server host** commands can be used.

If no host-specific timeout, retransmit, deadtime or key values are specified, the global values apply to each host.

To define a radius server on the out-of-band port, use the out-of-band IP address format —**oob/ip-address**.

The address type of the source parameter must be the same as the ip-address parameter.

Example

The following example specifies a RADIUS server host with the following characteristics:

- Server host IP address — 192.168.10.1
- Authentication port number — 20
- Timeout period — 20 seconds

```
Console (config)# radius-server host 192.168.10.1 auth-port 20 timeout 20
```

5.18.2 radius-server key

The **radius-server key** global configuration command sets the authentication and encryption key for all RADIUS communications between the router and the RADIUS daemon. To reset to the default, use the **no** form of this command.

Syntax

radius-server key *[key-string]*

no radius-server key

- *key-string* — Specifies the authentication and encryption key for all RADIUS communications between the router and the RADIUS server. This key must match the encryption used on the RADIUS daemon. The key can be up to 128 characters long.

Default Configuration

The default is an empty string.

Command Mode

Global Configuration mode

User Guidelines

There are no user guidelines for this command.

Example

The following example sets the authentication and encryption key for all RADIUS communications between the device and the RADIUS daemon to "abc-server".

```
Console (config)# radius-server key abc-server
```

5.18.3 radius-server retransmit

The **radius-server retransmit** global configuration command specifies the number of times the software searches the list of RADIUS server hosts. To reset the default configuration, use the **no** form of this command.

Syntax

radius-server retransmit *retries*

no radius-server retransmit

Default Configuration

The default is 3 attempts.

Command Mode

Global Configuration mode

User Guidelines

There are no user guidelines for this command.

Example

The following example configures the number of times the software searches the list of RADIUS server hosts to 5 attempts.

```
Console (config)# radius-server retransmit 5
```

5.18.4 radius-server source-ip

The **radius-server source-ip** global configuration command specifies the source IP address used for communication with RADIUS servers. To return to the default, use the **no** form of this command.

Syntax

radius-server source-ip *source*

no radius-server-ip

- *source* — Specifies the source IP address.

Default Configuration

The default IP address is the outgoing IP interface.

Command Mode

Global Configuration mode

User Guidelines

To define an out-of-band IP address, use the out-of-band IP address format **—oob/ip-address**.

Example

The following example configures the source IP address used for communication with RADIUS servers to 10.1.1.1.

```
Console (config)# radius-server source-ip 10.1.1.1
```

5.18.5 radius-server timeout

The **radius-server timeout** global configuration command sets the interval for which a router waits for a server host to reply. To restore the default, use the **no** form of this command.

Syntax

radius-server timeout *timeout*

no radius-server timeout

- *timeout* — Specifies the timeout value in seconds. (Range: 1 - 30)

Default Configuration

The default value is 3 seconds.

Command Mode

Global Configuration mode

User Guidelines

There are no user guidelines for this command.

Example

The following example sets the interval for which a router waits for a server host to reply to 5 seconds.

```
Console (config)# radius-server timeout 5
```

5.18.6 radius-server deadtime

The **radius-server deadtime** global configuration command improves RADIUS response times when servers are unavailable.

The command is used to cause the unavailable servers to be skipped. To reset the default value, use the **no** form of this command.

Syntax

radius-server deadtime *deadtime*

no radius-server deadtime

- *deadtime* — Length of time in minutes, for which a RADIUS server is skipped over by transaction requests. (Range: 0 - 2000)

Default Configuration

The default dead time is 0 minutes.

Command Mode

Global Configuration mode

User Guidelines

There are no user guidelines for this command.

Example

The following example sets a dead time where a RADIUS server is skipped over by transaction requests for this period, to 10 minutes.

```
Console (config)# radius-server deadline 10
```

5.18.7 show radius-servers

The show radius-servers user EXEC command displays the RADIUS server settings.

Syntax

show radius-servers

Default Configuration

This command has no default configuration.

Command Mode

User EXEC mode

User Guidelines

There are no user guidelines for this command.

Examples

The following example displays the RADIUS server settings.

```
Console# show radius-servers
```

| Port | | | | | | | | |
|------------|------|------|---------|------------|----------|-----------|----------|-------|
| IP address | Auth | Acct | TimeOut | Retransmit | Deadtime | Source IP | Priority | Usage |
| 172.16.1.1 | 1645 | 1646 | Global | Global | Global | Global | 1 | All |
| 172.16.1.2 | 1645 | 1646 | 11 | 8 | Global | Global | 2 | All |

OOB RADIUS servers

| Port | | | | | | | |
|------------|------|------|---------|------------|----------|-----------|----------|
| IP address | Auth | Acct | TimeOut | Retransmit | Deadtime | Source IP | Priority |
| 176.16.8.9 | 1645 | 1646 | Global | Global | Global | Global | 1 |

Global values

```
-----
TimeOut: 3
Retransmit: 3
Deadtime: 0
Source IP: 172.16.8.1
```

5.19 RMON Commands

5.19.1 show rmon statistics

The **show rmon statistics** user EXEC command displays RMON Ethernet Statistics.

Syntax

show rmon statistics {**ethernet** *interface number* | **port-channel** *port-channel-number*}

- *interface number* — Valid Ethernet port.
- *port-channel-number* — Valid port-channel trunk index.

Default Configuration

This command has no default configuration.

Command Mode

User EXEC mode

User Guidelines

There are no user guidelines for this command.

Example

The following example displays RMON Ethernet Statistics for port g1.

```

Console# show rmon statistics ethernet g1

Port g1

Dropped: 8

Octets: 878128 Packets: 978

Broadcast: 7 Multicast: 1

CRC Align Errors: 0 Collisions: 0

Undersize Pkts: 0 Oversize Pkts: 0

Fragments: 0 Jabbers: 0

64 Octets: 98 65 to 127 Octets: 0

128 to 255 Octets: 0 256 to 511 Octets: 0

512 to 1023 Octets: 491 1024 to 1518 Octets: 389

```

The following table describes the significant fields shown in the display:

| Field | Description |
|---------|---|
| Dropped | The total number of events in which packets are dropped by the probe due to lack of resources. This number is not always the number of packets dropped; it is the number of |

| | |
|----------------------------|---|
| | times this condition has been detected. |
| Octets | The total number of octets of data (including those in bad packets) received on the network (excluding framing bits but including FCS octets). |
| Packets | The total number of packets (including bad packets, broadcast packets, and multicast packets) received. |
| Broadcast | The total number of good packets received and directed to the broadcast address. This does not include multicast packets. |
| Multicast | The total number of good packets received and directed to a multicast address. This number does not include packets directed to the broadcast address. |
| CRC Align Errors | The total number of packets received with a length (excluding framing bits, but including FCS octets) of between 64 and 1518 octets, inclusive, but with either a bad Frame Check Sequence (FCS) with an integral number of octets (FCS Error) or a bad FCS with a non-integral number of octets (Alignment Error). |
| Undersize Pkts | The total number of packets received less than 64 octets long (excluding framing bits, but including FCS octets) and otherwise well formed. |
| Oversize Pkts | The total number of packets received longer than 1518 octets (excluding framing bits, but including FCS octets) and otherwise well formed. |
| Fragments | The total number of packets received less than 64 octets in length (excluding framing bits but including FCS octets) and either a bad Frame Check Sequence (FCS) with an integral number of octets (FCS Error) or a bad FCS with a non-integral number of octets (Alignment Error). |
| Jabbers | The total number of packets received longer than 1518 octets (excluding framing bits, but including FCS octets), and either a bad Frame Check Sequence (FCS) with an integral number of octets (FCS Error) or a bad FCS with a non-integral number of octets (Alignment Error). |
| Collisions | The best estimate of the total number of collisions on this Ethernet segment. |
| 64 Octets | The total number of packets (including bad packets) received that are 64 octets in length (excluding framing bits but including FCS octets). |
| 65 to 127 Octets | The total number of packets (including bad packets) received that are between 65 and 127 octets in length inclusive (excluding framing bits but including FCS octets). |
| 128 to 255 Octets | The total number of packets (including bad packets) received that are between 128 and 255 octets in length inclusive (excluding framing bits but including FCS octets). |
| 256 to 511 Octets | The total number of packets (including bad packets) received that are between 256 and 511 octets in length inclusive (excluding framing bits but including FCS octets). |
| 512 to 1023 Octets | The total number of packets (including bad packets) received that are between 512 and 1023 octets in length inclusive (excluding framing bits but including FCS octets). |
| 1024 to 1518 Octets | The total number of packets (including bad packets) received that are between 1024 and 1518 octets in length inclusive (excluding framing bits but including FCS octets). |

5.19.2 rmon collection history

The **rmon collection history** interface configuration command enables a Remote Monitoring (RMON) MIB history statistics group on an interface. To remove a specified RMON history statistics group, use the **no** form of this command.

Syntax

rmon collection history *index* [**owner** *ownername*] [**buckets** *bucket-number*] [**interval** *seconds*]

no rmon collection history *index*

- *Index* — The requested statistics index group. (Range: 1 - 65535)
- **owner** *ownername* — Records the RMON statistics group owner name. If unspecified, the name is an empty string.
- **buckets** *bucket-number* — A value associated with the number of buckets specified for the RMON collection history group of statistics. If unspecified, defaults to 50. (Range: 1 - 65535)
- **interval** *seconds* — The number of seconds in each polling cycle. If unspecified, defaults to 1800. (Range: 1 - 3600)

Default Configuration

This command has no default configuration.

Command Mode

Interface Configuration (Ethernet, port-channel) mode

User Guidelines

This command cannot be executed on multiple ports using the **interface range ethernet** command.

Example

The following example enables a Remote Monitoring (RMON) MIB history statistics group on port e8 with the index number "1" and a polling interval period of 2400 seconds.

```
Console (config)# interface ethernet e8
Console (config-if)# rmon collection history 1 interval 2400
```

5.19.3 show rmon collection history

The **show rmon collection history** user EXEC command displays the requested history group configuration.

Syntax

show rmon collection history [**ethernet** *interface* | **port-channel** *port-channel-number*]

- *interface* — Valid Ethernet port.
- *port-channel-number* — Valid port-channel trunk index.

Default Configuration

This command has no default configuration.

Command Mode

User EXEC mode

User Guidelines

There are no user guidelines for this command.

Example

The following example displays all RMON group statistics.

```

Console# show rmon collection history
Index      Interface      Interval      Requested      Granted      Owner
          -----      -
          Samples      Sample
-----
1          1          1000          50          50          CLI
  
```

The following table describes the significant fields shown in the display:

| Field | Description |
|-------------------|--|
| Index | An index that uniquely identifies the entry. |
| Interface | The sampled Ethernet interface |
| Interval | The interval in seconds between samples. |
| Requested Samples | The requested number of samples to be saved. |
| Granted Samples | The granted number of samples to be saved. |
| Owner | The entity that configured this entry. |

5.19.4 show rmon history

The **show rmon history** user EXEC command displays RMON Ethernet Statistics history.

Syntax

show rmon history *index* {**throughput** | **errors** | **other**} [**period** *seconds*]

- *index* — The requested set of samples. (Range: 1 - 65535)
- **throughput** — Displays throughput counters.
- **errors** — Displays error counters.
- **other** — Displays drop and collision counters.

- **period seconds** — Specifies the requested period time to display. (Range: 1 - 4294967295)

Default Configuration

This command has no default configuration.

Command Mode

User EXEC mode

User Guidelines

There are no user guidelines for this command.

Examples

The following example displays RMON Ethernet Statistics history for "throughput" on index number 5.

```

Console# show rmon history 5 throughput
Sample Set: 1 Owner: CLI
Interface: g1 Interval: 1800
Requested samples: 50 Granted samples: 50

Maximum table size: 500

```

| Time | Octets | Packets | Broadcast | Multicast | % |
|----------------------|-----------|---------|-----------|-----------|--------|
| Jan 18 2002 21:57:00 | 303595962 | 357568 | 3289 | 7287 | 19.98% |
| Jan 18 2002 21:57:30 | 287696304 | 275686 | 2789 | 2789 | 20.17% |

The following example displays RMON Ethernet Statistics history for "errors" on index number 5.

```

Console# show rmon history 5 errors
Sample Set: 1 Owner: CLI
Interface: 1/g1 Interval: 1800
Requested samples: 50 Granted samples: 50

Maximum table size: 500

```

| Time | CRC Align | Undersize | Oversize | Fragments | Jabbers |
|----------------------|-----------|-----------|----------|-----------|---------|
| Jan 18 2002 21:57:00 | 1 | 1 | 49 | 0 | 0 |
| Jan 18 2002 21:57:30 | 1 | 1 | 27 | 0 | 0 |

The following example displays RMON Ethernet Statistics history for "other" on index number 5.

```

Console# show rmon history 5 other
Sample Set: 1                               Owner: CLI
Interface: 1/g1                             Interval: 1800
Requested samples: 50                       Granted samples: 50

Maximum table size: 500

Time                                         Dropped                                         Collisions
-----                                         -
Jan 18 2002 21:57:00                         3                                               0
Jan 18 2002 21:57:30                         3                                               0

```

The following table describes the significant fields shown in the display:

| Field | Description |
|--------------|---|
| Time | Date and Time the entry is recorded. |
| Octets | The total number of octets of data (including those in bad packets) received on the network (excluding framing bits but including FCS octets) |
| Packets | The number of packets (including bad packets) received during this sampling interval. |
| Broadcast | The number of good packets received during this sampling interval that were directed to the broadcast address. |
| Multicast | The number of good packets received during this sampling interval that were directed to a multicast address. This number does not include packets addressed to the broadcast address. |
| Utilization% | The best estimate of the mean physical layer network utilization on this interface during this sampling interval, in hundredths of a percent. |
| CRC | Align The number of packets received during this sampling interval that had a length (excluding framing bits but including FCS octets) between 64 and 1518 octets, inclusive, but had either a bad Frame Check Sequence (FCS) with an integral number of octets (FCS Error) or a bad FCS with a nonintegral number of octets (Alignment Error). |
| Undersize | The number of packets received during this sampling interval that were less than 64 octets long (excluding framing bits but including FCS octets) and were otherwise well formed. |
| Oversize | The number of packets received during this sampling interval that were longer than 1518 octets (excluding framing bits but including FCS octets) but were otherwise well formed. etherHistoryFragments to increment because it counts both runts (which are normal occurrences due to collisions) and noise hits. |

| | |
|------------|--|
| Fragments | The total number of packets received during this sampling interval that were less than 64 octets in length (excluding framing bits but including FCS octets) had either a bad Frame Check Sequence (FCS) with an integral number of octets (FCS Error), or a bad FCS with a non-integral number of octets (AlignmentError). It is normal for |
| Jabbers | The number of packets received during this sampling interval that were longer than 1518 octets (excluding framing bits but including FCS octets), and had either a bad Frame Check Sequence (FCS) with an integral number of octets (FCS Error) or a bad FCS with a non-integral number of octets (Alignment Error). |
| Dropped | The total number of events in which packets were dropped by the probe due to lack of resources during this sampling interval. This number is not necessarily the number of packets dropped, it is just the number of times this condition has been detected. |
| Collisions | The best estimate of the total number of collisions on this Ethernet segment during this sampling interval. |

5.19.5 rmon alarm

The **rmon alarm** global configuration command configures alarm conditions. To remove an alarm, use the **no** form of this command.

Syntax

rmon alarm *index variable interval rthreshold fthreshold revert fevent* [**type** *type*] [**startup** *direction*] [**owner** *name*]

no rmon alarm *index*

- *index* — The alarm index. (Range: 1 - 65535)
- *variable* — The object identifier of the particular variable to be sampled.
- *interval* — The interval in seconds over which the data is sampled and compared with the rising and falling thresholds. (Range: 1 - 4294967295)
- *rthreshold* — Rising Threshold. (Range: 1 - 4294967295)
- *fthreshold* — Falling Threshold. (Range: 1 - 4294967295)
- *revert* — The Event index used when a rising threshold is crossed. (Range: 0 - 65535)
- *fevent* — The Event index used when a falling threshold is crossed. (Range: 0 - 65535)
- **type** *type* — The sampling method for the selected variable and calculating the value to be compared against the thresholds. If the method is **absolute**, the value of the selected variable is compared directly with the thresholds at the end of the sampling interval. If the method is **delta**, the selected variable value at the last sample is subtracted from the current value, and the difference compared with the thresholds.

- **startup direction** — The alarm that may be sent when this entry is first set to valid. If the first sample (after this entry becomes valid) is greater than or equal to the *rthreshold*, and *direction* is equal to **rising** or **rising-falling**, then a single rising alarm is generated. If the first sample (after this entry becomes valid) is less than or equal to the *fthreshold*, and *direction* is equal to **falling** or **rising-falling**, then a single falling alarm is generated.
- **owner name** — Enter a name that specifies who configured this alarm. If unspecified, the name is an empty string.

Default Configuration

The following parameters have the following default values:

type type — If unspecified, the type is **absolute**.

startup direction — If unspecified, the startup direction is **rising-falling**.

Command Mode

Global Configuration mode

User Guidelines

There are no user guidelines for this command.

Example

The following example configures the following alarm conditions:

- Alarm index — 1000
- Variable identifier — abc
- Sample interval — 360000 seconds
- Rising threshold — 1000000
- Falling threshold — 1000000
- Rising threshold event index — 10
- Falling threshold event index — 20

```
Console (config)# rmon alarm 1000 abc 360000 1000000 1000000 10 20
```

5.19.6 show rmon alarm-table

The **show rmon alarm-table** user EXEC command displays the alarms summary table.

Syntax

show rmon alarm-table

Default Configuration

This command has no default configuration.

Command Mode

User EXEC mode

User Guidelines

There are no user guidelines for this command.

Example

The following example displays the alarms summary table.

```

Console# show rmon alarm-table

Index      OID                               Owner
-----
1          1.3.6.1.2.1.2.2.1.10.1          CLI
2          1.3.6.1.2.1.2.2.1.10.1          Manager
3          1.3.6.1.2.1.2.2.1.10.9          CLI

```

The following table describes the significant fields shown in the display:

| Field | Description |
|-------|--|
| Index | An index that uniquely identifies the entry. |
| OID | Monitored variable OID. |
| Owner | The entity that configured this entry. |

5.19.7 show rmon alarm

The **show rmon alarm** user EXEC command displays alarm configuration.

Syntax

show rmon alarm *number*

- *number* — Alarm index. (Range: 1 - 65535)

Default Configuration

This command has no default configuration.

Command Mode

User EXEC mode

User Guidelines

There are no user guidelines for this command.

Example

The following example displays RMON 1 alarms.

```

Console# show rmon alarm 1
Alarm 1
-----
OID: 1.3.6.1.2.1.2.2.1.10.1
Last sample Value: 878128
Interval: 30
Sample Type: delta
Startup Alarm: rising
Rising Threshold: 8700000
Falling Threshold: 78
Rising Event: 1
Falling Event: 1
Owner: CLI

```

The following table describes the significant fields shown in the display:

| Field | Description |
|-------------------|---|
| OID | Monitored variable OID. |
| Last Sample Value | The statistic value during the last sampling period. For example, if the sample type is delta, this value is the difference between the samples at the beginning and end of the period. If the sample type is absolute, this value is the sampled value at the end of the period. |
| Alarm | Alarm index. |
| Owner | The entity that configured this entry. |
| Interval | The interval in seconds over which the data is sampled and compared with the rising and falling thresholds. |
| Sample Type | The method of sampling the variable and calculating the value compared against the thresholds. If the value is absolute , the value of the variable is compared directly with the thresholds at the end of the sampling interval. If the value is delta , the value of the variable at the last sample is subtracted from the current value, and the difference compared with the thresholds. |
| Startup Alarm | The alarm that may be sent when this entry is first set. If the first sample is greater than or equal to the rising threshold, and startup alarm is equal to rising or rising and falling, then a single rising alarm is generated. If the first sample is less than or equal to the falling threshold, and startup alarm is equal falling or rising and falling, then a single falling alarm |

| | |
|-------------------|---|
| | is generated. |
| Rising Threshold | A sampled statistic threshold. When the current sampled value is greater than or equal to this threshold, and the value at the last sampling interval is less than this threshold, a single event is generated. |
| Falling Threshold | A sampled statistic threshold. When the current sampled value is less than or equal to this threshold, and the value at the last sampling interval is greater than this threshold, a single event is generated. |
| Rising Event | The event index used when a rising threshold is crossed. |
| Falling Event | The event index used when a falling threshold is crossed. |

5.19.8 rmon event

The **rmon event** global configuration command configures an event. To remove an event, use the **no** form of this command.

Syntax

rmon event *index type* [**community** *text*] [**description** *text*] [**owner** *name*]

no rmon event *index*

- *index* — The event index. (Range: 1 - 65535)
- *type* — The type of notification that the device generates about this event. Can have the following values: **none**, **log**, **trap**, **log-trap**. In the case of log, an entry is made in the log table for each event. In the case of trap, an SNMP trap is sent to one or more management stations.
- **community** *text* — If an SNMP trap is to be sent, it is sent to the SNMP community specified by this octet string. (Range: 0-127 characters)
- **description** *text* — A comment describing this event. (Range: 0-127 characters)
- **owner** *name* — Enter a name that specifies who configured this event. If unspecified, the name is an empty string. (Range: 0-127 characters)

Default Configuration

This command has no default configuration.

Command Mode

Global Configuration mode

User Guidelines

There are no user guidelines for this command.

Example

The following example configures an event with the trap index of 10

```
Console (config)# rmon event 10 log
```

5.19.9 show rmon events

The **show rmon events** user EXEC command displays the RMON event table.

Syntax

show rmon events

Default Configuration

This command has no default configuration.

Command Mode

User EXEC mode

User Guidelines

There are no user guidelines for this command.

Example

The following example displays the RMON event table.

```
Console# show rmon events
```

| Index | Description | Type | Community | Owner | Last time sent |
|-------|----------------|----------|-----------|---------|----------------------|
| 1 | Errors | Log | | CLI | Jan 18 2002 23:58:17 |
| 2 | High Broadcast | Log-Trap | router | Manager | Jan 18 2002 23:59:48 |

The following table describes the significant fields shown in the display:

| Field | Description |
|-------------|---|
| Index | An index that uniquely identifies the event. |
| Description | A comment describing this event. |
| Type | The type of notification that the device generates about this event. Can have the following |

| | |
|----------------|--|
| | values: none , log , trap , log-trap . In the case of log, an entry is made in the log table for each event. In the case of trap, an SNMP trap is sent to one or more management stations. |
| Community | If an SNMP trap is to be sent, it is sent to the SNMP community specified by this octet string. |
| Owner | The entity that configured this event. |
| Last time sent | The time this entry last generated an event. If this entry has not generated any events, this value is zero. |

5.19.10 show rmon log

The **show rmon log** user EXEC command displays the RMON logging table.

Syntax

show rmon log [*event*]

- *event* — Event index. (Range: 0 - 65535)

Default Configuration

This command has no default configuration.

Command Mode

User EXEC mode

User Guidelines

There are no user guidelines for this command.

Example

The following example displays the RMON logging table.

```

Console# show rmon log

Maximum table size: 500

Event          Description          Time
-----
1              Errors              Jan 18 2002 23:48:19
1              Errors              Jan 18 2002 23:58:17
2              High Broadcast      Jan 18 2002 23:59:48

Console# show rmon log

Maximum table size: 500 (800 after reset)

Event          Description          Time
-----

```

| | | |
|---|----------------|----------------------|
| 1 | Errors | Jan 18 2002 23:48:19 |
| 1 | Errors | Jan 18 2002 23:58:17 |
| 2 | High Broadcast | Jan 18 2002 23:59:48 |

The following table describes the significant fields shown in the display:

| Field | Description |
|-------------|--|
| Event | An index that uniquely identifies the event. |
| Description | A comment describing this event. |
| Time | The time this entry created. |

5.19.11 rmon table-size

The **rmon table-size** global configuration command configures the maximum RMON tables sizes. To return to the default configuration, use the **no** form of this command.

Syntax

rmon table-size {**history entries** | **log entries**}

no rmon table-size {**history** | **log**}

- **history entries** — Maximum number of history table entries. (Range: 20 - 32767)
- **log entries** — Maximum number of log table entries. (Range: 20 - 32767)

Default Configuration

History table size is 270.

Log table size is 100.

Command Mode

Global Configuration mode

User Guidelines

The configured table size is effective after the device is rebooted.

Example

The following example configures the maximum RMON history table sizes to 1000 entries.

```
Console (config)# rmon table-size history 1000
```

5.20 SNMP Commands

5.20.1 snmp-server community

The **snmp-server community** global configuration command sets up the community access string to permit access to the SNMP protocol. To remove the specified community string, use the **no** form of this command.

Syntax

snmp-server community *community* [ro | rw | su] [*ip-address*]

snmp-server community-group *community group-name* [*ip-address*]

no snmp-server community *string* [*ip-address*]

- *community* — Character string that acts like a password and permits access to the SNMP protocol. (Range: 1 - 20 characters)
- **ro** — Specifies read-only access.
- **rw** — Specifies read-write access.
- **su** — Specifies SNMP administrator access.
- *ip-address* — Management station IP address. Default is all IP addresses. An out-of-band IP address can be specified as described in the usage guidelines.
- *group-name* — Name of a previously defined group. The group defines the objects available to the community. (Range: 1 - 30 characters)
- The **View-name** command cannot be specified for **su**, which has access to the whole MIB. However, the **View-name** command can be used to restrict the access rights of a community string.

Specifying a view-name parameter does the following:

- Generates an internal security-name.
- Maps the internal security-name for SNMPv1 and SNMPv2 security models to an internal group-name.
- Maps the internal group-name for SNMPv1 and SNMPv2 security models to view-name (read-view and notify-view always, and for rw for write-view also)

The **group-name** command can be used to restrict the access rights of a community string.

Specifying a group-name parameter does the following:

- Generates an internal security-name.
- Maps the internal security-name for SNMPv1 and SNMPv2 security models to the group-name.

To define a management station on the out-of-band port, use the out-of-band IP address format —**oob/ipaddress**.

For a user to define OOB management port configurations, such as ip address, default gateway, RADIUS, and so forth, you must define two SNMP communities. A super user can configure OOB management port settings with a single community, by switching between the two communities.

The OOB/ip address indicates whether the selected management station being configured is an OOB management station.

The **type** is used for a different purpose. From an SNMP perspective, the OOB port is treated as a separate device. Therefore, when defining an SNMP community, the administrator must indicate which tables are being configured. If **type** is **oob**, this indicates that OOB tables are being configured. If **type** is **router**, it means that the device's tables are being configured.

Default Configuration

No community is defined.

Command Mode

Global Configuration mode

User Guidelines

There are no user guidelines for this command.

Examples

The following example sets up the community access string "public" to permit administrative access to SNMP protocol, at an administrative station with the IP address 192.168.1.20.

```
Console (config)# snmp-server community public su 192.168.1.20
```

The following examples set up the community access string "public" to permit read-write access to SNMP protocol, using the out-of-band port for 192.175.1.10.

```
Console (config)# snmp-server community public rw 192.175.1.10 type oob
```

5.20.2 snmp-server contact

The **snmp-server contact** global configuration command sets up a system contact. To remove the system contact information, use the **no** form of the command.

Syntax

snmp-server contact *text*

no snmp-server contact

- *text* — Character string, up to 160 characters, describing the system contact information.

Default Configuration

This command has no default configuration.

Command Mode

Global Configuration mode

User Guidelines

Do not include spaces in the text string.

Example

The following example displays setting up the system contact point as "abc_Technical_Support".

```
Console (config)# snmp-server contact abc_Technical_Support
```

5.20.3 snmp-server location

The **snmp-server location** global configuration command sets up information on where the device is located. To remove the location string use, the **no** form of this command.

Syntax

snmp-server location *text*

no snmp-server location

text — Character string, up to 160 characters, describing the system location.

Default Configuration

This command has no default configuration.

Command Mode

Global Configuration mode

User Guidelines

Do not include spaces in the text string.

Example

The following example sets the device location as "New_York".

```
Console (config)# snmp-server location New_York
```

5.20.4 snmp-server enable traps

The **snmp-server enable traps** global configuration command enables the switch to send SNMP traps. To disable SNMP traps use the **no** form of the command.

Syntax

snmp-server enable traps

no snmp-server enable traps

Default Configuration

Enabled

Command Mode

Global Configuration mode

User Guidelines

There are no user guidelines for this command.

Examples

The following example displays the command to enable SNMP traps.

```
Console (config)# snmp-server enable traps
```

5.20.5 snmp-server trap authentication

The **snmp-server trap authentication** global configuration command enables the switch to send Simple Network Management Protocol traps when authentication fails. To disable SNMP authentication failed traps, use the **no** form of this command.

Syntax

snmp-server trap authentication

no snmp-server trap authentication

Default Configuration

This command has no default configuration.

Command Mode

Global Configuration mode

User Guidelines

There are no user guidelines for this command.

Examples

The following example displays the command to enable authentication failed SNMP traps.

```
Console (config)# snmp-server trap authentication
Console (config)# snmp-server host 10.1.1.1 management 2
```

5.20.6 snmp-server host

The **snmp-server host** global configuration command specifies the recipient of Simple Network Management Protocol notification operation. To remove the specified host, use the **no** form of this command.

Syntax

snmp-server host *host-addr community-string* [1 | 2]

no snmp-server host *host-addr*

- *host-address* — Internet address of the host (the targeted recipient). An out-of-band IP address can be specified as described in the User Guidelines.

- *community-string* — Password-like community string sent with the notification operation. (Range: 1 - 20 characters)
- **1** — SNMPv1 traps is used.
- **2** — SNMPv2 traps is used (Default).

Default Configuration

The default is SNMPv2.

UDP Port - 162

timeout - 15 seconds

retries - 3.

Command Mode

Global Configuration mode

User Guidelines

If a trap and inform are defined on the same target, and an inform was sent, the trap is not sent.

An inform request is held in memory until a response is received or the request times out. An inform can be resent or retried several times, but traps are sent only once. Network traffic is increased with retries. Therefore, traps and informs require a trade-off between reliability and resources. Inform requests should be used, if it is important that the SNMP manager receives every notification. If traffic on the network or memory in the switch is a concern and notification is not required, traps should be used.

To define an SNMP recipient on the out-of-band port, use the out-of-band IP address format — **oob/ip-address**.

Use only unicast IP addresses.

Example

The following example enables SNMP traps for host 10.1.1.1 with community string "management" using SNMPv2.

```
Console (config)# snmp-server host 10.1.1.1 management 2
```

5.20.7 snmp-server set

The **snmp-server set** global configuration command sets SNMP MIB value by the CLI.

Syntax

```
snmp-server set variable-name name1 value1 [name2 value2 ...]
```

- *variable-name* — MIB variable name.
- *name value...* — List of name and value pairs. In case of scalar MIBs there is only a single pair of name values. In case of entry in a table the first pairs are the indexes, followed by one or more fields.

Default Configuration

This command has no default configuration.

Command Mode

Global Configuration mode

User Guidelines

Although the CLI can set any required configuration, there might be a situation where a SNMP user sets a MIB variable that does not have an equivalent command. In order to generate configuration files that support those situations, the **snmp-server set** command is used.

This command is context sensitive.

Examples

The following example sets the scalar MIB "sysName" to have the value "abc".

```
Console (config)# snmp-server set sysName sysname abc
```

The following example sets the entry MIB "rndCommunityTable" with keys 0.0.0.0 and "public". The field rndCommunityAccess gets the value "super" and the rest of the fields get their default values.

```
Console (config)# snmp-server set rndCommunityTable
rndCommunityMngStationAddr 0.0.0.0 rndCommunityString public
rndCommunityAccess super
```

5.20.8 show snmp

The **show snmp** privileged EXEC command displays the SNMP status.

Syntax

```
show snmp
```

Default Configuration

This command has no default configuration.

Command Mode

Privileged EXEC mode

User Guidelines

There are no user guidelines for this command.

Example

The following example displays the SNMP communications status.

```
Console# show snmp
```

| Community-String | Community-Access | IP address |
|---|--------------------|------------|
| public | read only | All |
| private | read write | 172.16.1.1 |
| private | read write | 172.17.1.1 |
| OOB management stations | | |
| Community-String | Community-Access | IP address |
| private | read write | 176.16.8.9 |
| Traps are enabled. Authentication trap is enabled. | | |
| Trap-Rec-Address | Trap-Rec-Community | Version |
| 192.122.173.42 | public | 2 |
| OOB trap receivers | | |
| Trap-Rec-Address | Trap-Rec-Community | Version |
| 176.16.8.9 | public | 2 |
| System Contact: Robert | | |
| System Location: Marketing | | |

5.21 Spanning-Tree Commands

5.21.1 spanning-tree

The **spanning-tree** global configuration command enables spanning-tree functionality. To disable spanning-tree functionality, use the **no** form of this command.

Syntax

spanning-tree

no spanning-tree

Default Configuration

Spanning-tree is enabled.

Command Modes

Global Configuration mode

User Guidelines

There are no user guidelines for this command.

Example

The following example enables spanning-tree functionality.

```
Console(config)# spanning-tree
```

5.21.2 spanning-tree mode

The **spanning-tree mode** global configuration command configures the spanning-tree protocol. To return to the default configuration, use the **no** form of this command.

Syntax

spanning-tree mode {**stp** | **rstp**}

no spanning-tree mode

- **stp** — STP is supported.
- **rstp** — RSTP is supported.

Default Configuration

Spanning-tree protocol (STP) is supported.

Command Modes

Global Configuration mode

User Guidelines

There are no user guidelines for this command.

Example

The following example configures the spanning-tree protocol to RSTP.

```
Console(config)# spanning-tree mode rstp
```

5.21.3 spanning-tree forward-time

The **spanning-tree forward-time** global configuration command configures the spanning-tree bridge forward time, which is the amount of time a port remains in the listening and learning states before entering the forwarding state.

To reset the default forward time, use the **no** form of this command.

Syntax

spanning-tree forward-time *seconds*

no spanning-tree forward-time

- *seconds* — Time in seconds .(Range: 4 - 30)

Default Configuration

The default forwarding-time for IEEE Spanning-tree Protocol (STP) is 15 seconds.

Command Modes

Global Configuration mode

User Guidelines

There are no user guidelines for this command.

Example

The following example configures spanning-tree bridge forward time to 25 seconds.

```
Console(config)# spanning-tree forward-time 25
```

5.21.4 spanning-tree hello-time

The **spanning-tree hello-time** global configuration command configures the spanning-tree bridge hello time, which is how often the switch broadcasts hello messages to other switches. To reset the default hello time, use the **no** form of this command.

Syntax

spanning-tree hello-time *seconds*

no spanning-tree hello-time

- *seconds* — Time in seconds. (Range: 1 - 10)

Default Configuration

The default hello time for IEEE Spanning-Tree Protocol (STP) is 2 seconds.

Command Modes

Global Configuration mode

User Guidelines

There are no user guidelines for this command.

Example

The following example configures spanning-tree bridge hello time to 5 seconds.

```
Console(config)# spanning-tree hello-time 5
```

5.21.5 spanning-tree max-age

The **spanning-tree max-age** global configuration command configures the spanning-tree bridge maximum age.

To reset the default maximum age, use the **no** form of this command.

Syntax

spanning-tree max-age *seconds*

no spanning-tree max-age

- *seconds* -Time in seconds. (Range: 6 - 40)

Default Configuration

The default max-age for IEEE STP is 20 seconds.

Command Modes

Global Configuration mode

User Guidelines

There are no user guidelines for this command.

Example

The following example configures the spanning-tree bridge maximum-age to 10 seconds.

```
Console(config)# spanning-tree max-age 10
```

5.21.6 spanning-tree priority

The **spanning-tree priority** global configuration command configures the spanning-tree priority. The priority value is used to determine which bridge is elected as the root bridge. To reset the default spanning-tree priority use the **no** form of this command.

Syntax

spanning-tree priority *priority*

no spanning-tree priority

- *priority* — Priority of the bridge. (Range: 0 - 61440 in steps of 4096)

Default Configuration

The default bridge priority for IEEE STP is 32768.

Command Modes

Global Configuration mode

User Guidelines

The lower the priority, the more likely the bridge is to be the Root Bridge.

Example

The following example configures spanning-tree priority to 12288.

```
Console(config)# spanning-tree priority 12288
```

5.21.7 spanning-tree disable

The **spanning-tree disable** interface configuration command disables spanning-tree on a specific port. To enable spanning-tree on a port use, the **no** form of this command.

Syntax

spanning-tree disable

no spanning-tree disable

Default Configuration

By default, all ports are enabled for spanning-tree.

Command Modes

Interface Configuration (Ethernet, port-channel) mode

User Guidelines

There are no user guidelines for this command.

Example

The following example disables spanning-tree on e5.

```
Console (config)# interface ethernet e5
Console (config-if)# spanning-tree disable
```

5.21.8 spanning-tree cost

The **spanning-tree cost** interface configuration command configures the spanning-tree path cost for a port. To reset the default port path cost, use the **no** form of this command.

Syntax

spanning-tree cost *cost*

no spanning-tree cost

- *cost* — The port path cost (Range: 1 - 200,000,000)

Default Configuration

The default costs are as follows:

Port Channel — 20,000

1000 mbps (giga) — 20,000

100 mbps — 200,000

10 mbps — 2,000,000

Command Modes

Interface Configuration (Ethernet, port-channel) mode

User Guidelines

The method used (long or short) is set by using the **spanning-tree pathcost method** command.

Example

The following example configures the spanning-tree cost on e5 to 35000.

```
Console(config)# interface ethernet e5
Console(config-if)# spanning-tree cost 35000
```

5.21.9 spanning-tree port-priority

The **spanning-tree port-priority** interface configuration command configures port priority. To reset the default port priority, use the **no** form of this command.

Syntax

spanning-tree port-priority *priority*

no spanning-tree port-priority

- *priority* — The port priority. (Range: 0 - 240 in multiples of 16)

Default Configuration

The default port-priority for IEEE STP is 128.

Command Modes

Interface Configuration (Ethernet, port-channel) mode

User Guidelines

There are no user guidelines for this command.

Example

The following example configures the spanning priority on e5 to 96.

```
Console(config)# interface ethernet e5
Console(config-if)# spanning-tree port-priority 96
```

5.21.10 spanning-tree portfast

The **spanning-tree portfast** interface configuration command enables PortFast mode. In PortFast mode, the interface is immediately put into the forwarding state upon linkup, without waiting for the timer to expire. To disable PortFast mode, use the **no** form of this command.

Syntax

spanning-tree portfast

no spanning-tree portfast

Default Configuration

PortFast mode is disabled.

Command Modes

Interface Configuration (Ethernet, port-channel) mode

User Guidelines

This feature should be used only with interfaces connected to end stations. Otherwise, an accidental topology loop could cause a data packet loop and disrupt switch and network operations.

Example

The following example enables PortFast on e5.

```
Console(config)# interface ethernet e5
Console(config-if)# spanning-tree portfast
```

5.21.11 spanning-tree link-type

The **spanning-tree link-type** interface configuration command overrides the default link-type setting. To reset the default, use the **no** form of this command.

Syntax

spanning-tree link-type {point-to-point | shared}

no spanning-tree spanning-tree link-type

- **point-to-point** — Specifies the port link type as point-to-point.
- **shared** — Specifies that the port link type is shared.

Default Configuration

The switch derives the link type of a port from the duplex mode. A full-duplex port is considered a point-to-point link, and a half-duplex port is considered a shared link.

Command Modes

Interface Configuration (Ethernet, port-channel) mode

User Guidelines

There are no user guidelines for this command.

Example

The following example enables shared spanning-tree on e5.

```
Console(config)# interface ethernet e5
Console(config-if)# spanning-tree link-type shared
```

5.21.12 spanning-tree pathcost method

The **spanning-tree pathcost method** command sets the default path cost method. To revert to the default setting, use the **no** form of this command.

Syntax

spanning-tree pathcost method {**long** | **short**}

no spanning-tree pathcost method

- *long* — Specifies 1 through 200,000,000 range for port path costs.
- *short* — Specifies 1 through 200,000,000 range for port path costs.

Default Configuration

Auto

Command Mode

Global configuration mode

User Guidelines

This command applies to all the spanning tree instances on the switch.

The priority value must be a multiple of 4096.

The cost is set using the **spanning-tree cost** command.

Example

The following example sets the default path cost method to "long".

```
Console# spanning-tree pathcost method long
```

5.21.13 spanning-tree bpdud

The **spanning-tree bpdud** global configuration command defines BPDU handling when spanning-tree is disabled on an interface.

Syntax

spanning-tree bpdud {**filtering** | **flooding**}

- **filtering** — Filter BPDU packets when spanning-tree is disabled on an interface.
- **flooding** — Flood BPDU packets when spanning-tree is disabled on an interface.

Default Configuration

The default definition is flooding.

Command Modes

Global Configuration mode

User Guidelines

The command is relevant when spanning-tree is disabled globally or on a single interface..

Example

The following example defines BPDU packet flooding when spanning-tree is disabled on an interface.

```
Console(config)# spanning-tree bpdu flooding
```

5.21.14 clear spanning-tree detected-protocols

The **clear spanning-tree detected-protocols** privileged EXEC command restarts the protocol migration process (force the renegotiation with neighboring switches) on all interfaces or on the specified interface.

Syntax

clear spanning-tree detected-protocols [**ethernet interface number** | **port-channel port-channel-number**]

- *interface* — A valid Ethernet port.
- *port-channel-number* — A port-channel index.

Default Configuration

If no interface is specified, the action is applied to all interfaces.

Command Modes

Privileged EXEC mode

User Guidelines

This feature should be used only when working in RSTP mode.

Example

The following example restarts the protocol migration process (forces the renegotiation with neighboring switches) on g1.

```
Console# clear spanning-tree detected-protocols ethernet g1
```

5.21.15 show spanning-tree

The **show spanning-tree** privileged EXEC command displays spanning-tree configuration.

Syntax

show spanning-tree [**ethernet** *interface* | **port-channel** *port-channel-number*]

show spanning-tree [**detail**] [**active** | **blockedports**]

- *interface* — The full syntax is: *unit/port*. (Range: Valid Ethernet port)
- *port-channel-number* — Port channel index. (Range: Valid port channel)
- *instance-id* — ID associated with a spanning-tree instance. (Range: 1 - 15)
- **detail** — Display detailed information.
- **active** — Display active ports only.
- **blockedports** — Display blocked ports only.

Default Configuration

This command has no default configuration.

Command Modes

Privileged EXEC mode

User Guidelines

There are no user guidelines for this command.

Examples

The following example displays spanning-tree information.

```

Console# show spanning-tree

Spanning tree enabled mode RSTP
Default port cost method: short

Root ID      Priority      32768
            Address      0001.4297.e000
            Cost        57
            Port g      1

Hello Time 2 sec Max Age 20 sec Forward Delay 15 sec

Bridge ID    Priority      32768
            Address      0002.4b29.7a00

Hello Time 2 sec Max Age 20 sec Forward Delay 15 sec

Number of topology changes 2 last change occurred 2d18h ago

Times:          hold 1, topology change 35, notification 2

```

```
hello 2, max age 20, forward delay 15
```

| Interface | Port ID | Cost | Set | Designated | Port ID |
|-----------|-----------|------|-----|-------------------------|-----------|
| Name | Prio. Nbr | | | Cost Bridge ID | Prio. Nbr |
| g1 | 128.1 | 19 | FWD | 38 32768 0030.9441.62c1 | 128.25 |
| g2 | 128.2 | 19 | FWD | 57 32769 0002.4b29.7a00 | 128.25 |
| ch1 | 128.65 | 19 | FWD | 57 32769 0002.4b29.7a00 | 128.65 |

The following example displays spanning-tree information for port g1.

```
Console# show spanning-tree ethernet g1
```

| Interface | Port ID | Cost | Set | Designated | Port ID |
|-----------|-----------|------|-----|-------------------------|-----------|
| Name | Prio. Nbr | | | Cost Bridge ID | Prio. Nbr |
| g1 | 128.1 | 19 | FWD | 38 32768 0030.9441.62c1 | 128.25 |

Spanning tree enabled
Type: point-to-point (configured: auto)
Port Fast: no (configured: no)
Number of transitions to forwarding state: 1
BPDU: sent 2, received 120638

5.22 SSH and SLOGIN Commands

5.22.1 ip ssh port

The **ip ssh port** global configuration command specifies the port to be used by the SSH server. To use the default port, use the **no** form of this command.

Syntax

ip ssh port *port-number*

no ip ssh port

- *port-number* — Port number for use by the SSH server (Range: 1 - 65535).

Default Configuration

The default value is 22.

Command Mode

Global Configuration mode

User Guidelines

There are no user guidelines for this command.

Example

The following example specifies the port to be used by the SSH server as 8080.

```
Console (config)# ip ssh port 8080
```

5.22.2 ip ssh server

The **ip ssh server** global configuration command enables the device to be configured from a SSH server. To disable this function, use the **no** form of this command.

Syntax

```
ip ssh server
```

```
no ip ssh server
```

Default Configuration

This default is SSH is disabled.

Command Mode

Global Configuration mode

User Guidelines

If encryption keys are not generated, the SSH server is in standby until the keys are generated. To generate SSH server keys, use the commands **crypto key generate rsa**, and **crypto key generate dsa**.

Example

The following example enables the device to be configured from a SSH server.

```
Console (config)# ip ssh server
```

5.22.3 crypto key generate dsa

The **ip ssh server** global configuration command generates DSA key pairs.

Syntax

crypto key generate dsa

Default Configuration

DSA key pairs do not exist.

Command Mode

Global Configuration mode

User Guidelines

DSA keys are generated in pairs: one public DSA key and one private DSA key. If the device already has DSA keys, a warning and prompt to replace the existing keys with new keys is displayed.

The maximum supported size for the DSA key is 1,024.

This command is not saved in the startup configuration; however, the keys generated by this command are saved in the running configuration, which is never displayed to the user or backed up to another device.

This command may take a considerable period of time to execute.

DSA key size is 2048 bits.

Example

The following example generates DSA key pairs.

```
Console (config)# crypto key generate dsa
```

5.22.4 crypto key generate rsa

The **crypto key generate rsa** global configuration command generates RSA key pairs.

Syntax

crypto key generate rsa

Default Configuration

RSA key pairs do not exist.

Command Mode

Global Configuration mode

User Guidelines

RSA keys are generated in pairs: one public RSA key and one private RSA key. If the device already has RSA keys, a warning and prompt to replace the existing keys with new keys is displayed.

The maximum supported size for the RSA key is 2048 bits.

This command is not saved in the startup configuration; however, the keys generated by this command are saved in the running configuration, which is never displayed to the user or backed up to another device.

This command may take a considerable period of time to execute.

Example

The following example generates RSA key pairs.

```
Console (config)# crypto key generate rsa
```

5.22.5 ip ssh pubkey-auth

The **ip ssh pubkey-auth** global configuration command enables public key authentication for incoming SSH sessions.

To disable this function, use the **no** form of this command.

Syntax

ip ssh pubkey-auth

no ip ssh pubkey-auth

Default Configuration

The function is disabled.

Command Mode

Global Configuration mode

User Guidelines

AAA authentication is independent.

Example

The following example enables public key authentication for incoming SSH sessions.

```
Console (config)# ip ssh pubkey-auth
```

5.22.6 crypto key pubkey-chain ssh

The **crypto key pubkey-chain ssh** global configuration command enters SSH Public Key-chain configuration mode. The mode is used to manually specify other device public keys such as SSH client public keys.

Syntax

crypto key pubkey-chain ssh

Default Configuration

By default, there are no keys.

Command Mode

Global Configuration mode

User Guidelines

There are no user guidelines for this command.

Example

The following example enters the SSH Public Key-chain configuration mode.

```
Console(config)# crypto key pubkey-chain ssh
Console(config-pubkey-chain)#
```

5.22.7 user-key

The **user-key** SSH public key chain configuration command specifies which SSH public key is manually configured and enters the SSH public key-string configuration command. To remove a SSH public key, use the **no** form of this command.

Syntax

user-key *username* {**rsa** | **dsa**}

no user-key *username*

- *username* — Specifies the remote SSH client username, which can be up to 48 characters long.
- **rsa** — RSA key.
- **dsa** — DSA key.

Default Configuration

By default, there are no keys.

Command Mode

SSH Public Key Chain Configuration mode

User Guidelines

Follow this command with the key-string command to specify the key.

Example

The following example enables a SSH public key to be manually configured for the SSH public key chain called "bob".

```

Console(config-pubkey-chain)# user-key bob
Console(config-pubkey-key)# key-string rsa
AAAAB3NzaC1yc2EAAAADAQABAAQACvTnRwPWI

```

5.22.8 key-string

The **key-string** SSH public key-string configuration command manually specifies a SSH public key.

Syntax

key-string *text*

- *text* — Authentication string that must be sent and received in the packets, using the routing protocol being authenticated. The string can contain from 1 to 16 uppercase and lowercase alphanumeric characters.

Default Configuration

By default, the keys do not exist.

Command Mode

SSH Public Key-string configuration

User Guidelines

Use the **key-string row** command to specify the SSH public key row by row. Each row must begin with the **keystring row** command. This command is useful for configuration files.

UU-encoded DER format is the same format in `authorized_keys` file used by OpenSSH.

Example

The following example enters public key strings for SSH public key clients called "bob".

```

Console(config)# crypto key pubkey-chain ssh
Console(config-pubkey-chain)# user-key bob rsa
Console(config-pubkey-key)# key-string rsa
AAAAB3NzaC1yc2EAAAADAQABAAQACvTnRwPWI
Al4kpqIw9GBRonZQZxjHKcqKL6rMIQ+
ZNxfZSkvHG+QuslZ/76lLmFT34v7u7ChFAE+
Vu4GRfpSwoQUvV35LqJJK67IOU/zfwOI1g
kTwmI75QR9gHujS6KwGN2QWXgh3ub8gDjTSq
muSn/Wd05iDX2IExQWu08licglk02LYciz
+Z4TrEU/9FJxwPiVQOjc+KBXuR0juNg5nFYsY
0ZCk0N/W9a/tnkm1shRE7Di71+w3fNiOA
6w9o44t6+AINEICBCCA4Ycf6zMzaT1wefWwX6f+

```

```
Rmt5nhhqAtN/4oJfce166DqVX1gWmN
zNR4DYDvSzg0lDnwCAC8Qh

Fingerprint: a4:16:46:23:5a:8d:1d:b5:37:59:eb:44:13:b9:33:e9
```

5.22.9 show ip ssh

The **show ip ssh** privileged EXEC command displays the SSH server configuration.

Syntax

show ip ssh

Default Configuration

This command has no default configuration.

Command Mode

Privileged EXEC mode

User Guidelines

There are no user guidelines for this command.

Example

The following example displays the SSH server configuration.

```
Console# show ip ssh
SSH server enabled. Port: 22
RSA key was generated.
DSA (DSS) key was generated.
SSH Public Key Authentication is enabled.
Active incoming sessions:
IP address      SSH  username      Version      Cipher      Auth Code
-----
172.16.0.1     John Brown    2.0 3        DES          HMAC-SH1
```

The following table describes the significant fields shown in the display:

| Field | Description |
|--------------|---------------------------------------|
| IP address | Client address |
| SSH username | User name |
| Version | SSH version number |
| Cipher | Encryption type (3DES, Blowfish, RC4) |

| | |
|-----------|---|
| Auth Code | Authentication Code (HMAC-MD5, HMAC-SHA1) |
|-----------|---|

5.22.10 show crypto key mypubkey

The **show crypto key mypubkey** privileged EXEC command displays the SSH public keys on the device.

Syntax

show crypto key mypubkey [*rsa* | *dsa*]

rsa—RSA key.

dsa—DSA key.

Default Configuration

This command has no default configuration.

Command Mode

Privileged EXEC mode

User Guidelines

There are no user guidelines for this command.

Example

The following example displays the SSH public keys on the device.

```

Console# show crypto key mypubkey rsa
RSA key data:
005C300D 06092A86 4886F70D 01010105 00034B00 30480241 00C5E23B 55D6AB22
04AEF1BA A54028A6 9ACC01C5 129D99E4 64CAB820 847EDAD9 DF0B4E4C 73A05DD2
BD62A8A9 FA603DD2 E2A8A6F8 98F76E28 D58AD221 B583D7A4 71020301 87685768
Fingerprint(Hex): 77:C7:19:85:98:19:27:96:C9:CC:83:C5:78:89:F8:86
Fingerprint(Bubble Babble): yteriuwt jgkljhglk yewiury hdskjfryt gfhkjglk

```

5.22.11 show crypto key pubkey-chain ssh

The **show crypto key pubkey-chain ssh** privileged EXEC command displays SSH public keys stored on the device.

Syntax

show crypto key pubkey-chain ssh [*username username*] [*fingerprint bubble-babble* | *hex*]

- *username* — Specifies the remote SSH client username.
- **bubble-babble** — Fingerprints in Bubble Babble format.
- **hex** — Fingerprint in Hex format. If fingerprint is unspecified, it defaults to Hex format.

Default Configuration

This command has no default configuration.

Command Mode

Privileged EXEC mode

User Guidelines

There are no user guidelines for this command.

Examples

The following example displays all SSH public keys stored on the device.

```

Console# show crypto key pubkey-chain ssh

Username          Fingerprint
-----          -
bob               9A:CC:01:C5:78:39:27:86:79:CC:23:C5:98:59:F1:86
john              98:F7:6E:28:F2:79:87:C8:18:F8:88:CC:F8:89:87:C8

```

The following example displays the SSH public called "bob".

```

Console# show crypto key pubkey-chain ssh username bob

Username: bob

Key: 005C300D 06092A86

```

5.23 System Management

5.23.1 ping

The **ping** user EXEC command sends ICMP echo request packets to another node on the network.

Syntax

ping *ip-address* | *hostname* [**size** *packet_size*] [**count** *packet_count*] [**timeout** *time_out*]

- *ip-address* — IP address to ping. An out-of-band IP address can be specified as described in the usage guidelines.
- *hostname* — hostname to ping (Range: 1 - 160 characters)

- *packet_size* — Number of bytes in a packet. The actual packet size is eight bytes larger than the size specified because the switch adds header information. (Range: 57 - 1472 bytes)
- *packet_count* — Number of packets to send. If 0 is entered it pings until stopped. (Range: 1 - 65535 packets)
- *time_out* — Timeout in milliseconds to wait for each reply. (Range: 1 - 65535 milliseconds)

Default Configuration

The default packet size is 56 bytes.

The default packet count is 4 packets.

The default time-out is 1,000 milliseconds.

Command Mode

User EXEC mode

User Guidelines

Press **Esc** to stop pinging. Following are sample results of the **ping** command:

Destination does not respond—If the host does not respond, a “no answer from host” message appears in 10 seconds.

Destination unreachable—The gateway for this destination indicates that the destination is unreachable.

Network or host unreachable—The switch found no corresponding entry in the route table.

To ping an out-of-band IP address, use the out-of-band IP address format — **oob/ip-address**.

Examples

The following example displays a ping to IP address 10.1.1.1.

```

Console# ping 10.1.1.1
64 bytes from 10.1.1.1: icmp_seq=0. time=11 ms
64 bytes from 10.1.1.1: icmp_seq=1. time=8 ms
64 bytes from 10.1.1.1: icmp_seq=2. time=8 ms
64 bytes from 10.1.1.1: icmp_seq=3. time=7 ms
^C
----10.1.1.1 PING Statistics----
4 packets transmitted, 4 packets received, 0% packet loss
round-trip (ms) min/avg/max = 7/8/11
Console>

```

5.23.2 traceroute

The **traceroute** User EXEC command discovers the routes that packets will actually take when traveling to their destination.

Syntax

traceroute *ip-address* [*hostname* [**size** *packet_size*] [**ttl** *max-ttl*] [**count** *packet_count*] [**timeout** *time_out*] [**source** *ip-address*] [**tos** *tos*]

- *ip-address* — IP address of the destination host. An out-of-band IP address can be specified as described in the usage guidelines. (Range: 1 - 160 characters)
- *hostname* — Hostname of the destination host (Range: Valid IP Address)
- **size** *packet_size* — Number of bytes in a packet. (Range: 40-1500)
- **ttl** *max-ttl*—The largest TTL value that can be used. The **traceroute** command terminates when the destination is reached or when this value is reached. (Range:1-255)
- **count** *packet_count* — The number of probes to be sent at each TTL level. (Range:1-10)
- **timeout** *time_out* — The number of seconds to wait for a response to a probe packet. (Range:1-60)
- **source** *ip-address* — One of the interface addresses of the device to use as a source address for the probes. The device will normally pick what it feels is the best source address to use. (Range: Valid IP Address)
- **tos** *tos* — The Type-Of-Service byte in the IP Header of the packet. (Range: 0-255)

Default Configuration

size *packet_size* — The default is 40 bytes.

ttl *max-ttl* — The default is 30.

count *packet_count* — The default count is 3.

timeout *time_out* — The default is 3 seconds.

Command Mode

User EXEC mode

User Guidelines

The **traceroute** command works by taking advantage of the error messages generated by routers when a datagram exceeds its time-to-live (TTL) value.

The **traceroute** command starts by sending probe datagrams with a TTL value of one. This causes the first router to discard the probe datagram and send back an error message. The **traceroute** command sends several probes at each TTL level and displays the round-trip time for each.

The **traceroute** command sends out one probe at a time. Each outgoing packet may result in one or two error messages. A "time exceeded" error message indicates that an intermediate router has seen and discarded the probe. A "destination unreachable" error message indicates that the destination node has received the probe and discarded it because it could not deliver the packet. If the timer goes off before a response comes in, the **traceroute** command prints an asterisk (*).

The **traceroute** command terminates when the destination responds, when the maximum TTL is exceeded, or when the user interrupts the trace with **Esc**.

To find the trace to an out-of-band IP address, use the out-of-band IP address format: oob/ip-address.

Examples

```

console> traceroute umaxp1.physics.lsa.umich.edu

Type Esc to abort.

Tracing the route to umaxp1.physics.lsa.umich.edu (141.211.101.64)

 0 141.211.101.64 0 msec 0 msec 0 msec
 1 i2-gateway.stanford.edu (192.68.191.83) 0 msec 0 msec 0 msec
 2 STAN.POS.calren2.NET (171.64.1.213) 0 msec 0 msec 0 msec
 3 SUNV--STAN.POS.calren2.net (198.32.249.73) 1 msec 1 msec 1 msec
 4 Abilene--QSV.POS.calren2.net (198.32.249.162) 1 msec 1 msec 1 msec
 5 kscopyng-snvang.abilene.ucaid.edu (198.32.8.103) 33 msec 35 msec 35 msec
 6 iplsng-kscopyng.abilene.ucaid.edu (198.32.8.80) 47 msec 45 msec 45 msec
 7 so-0-2-0x1.aa1.mich.net (192.122.183.9) 56 msec 53 msec 54 msec
 8 atm1-0x24.michnet8.mich.net (198.108.23.82) 56 msec 56 msec 57 msec
 9 * * *
10 A-ARB3-LSA-NG.c-SEB.umnet.umich.edu (141.211.5.22) 58 msec 58 msec 58 msec
11 umaxp1.physics.lsa.umich.edu (141.211.101.64) 62 msec 63 msec 63 msec

```

The following table describes the significant fields shown in the display

| Field | Description |
|-------------------------|--|
| 1 | Indicates the sequence number of the router in the path to the host. |
| i2-gateway.stanford.edu | Host name of this router. |
| 192.68.191.83 | IP address of this router. |
| 1 msec 1 msec 1 msec | Round-trip time for each of the probes that are sent. |

The following table describes the characters that can appear in the **traceroute** command output.

| Field | Description |
|-------|---|
| * | The probe timed out. |
| ? | Unknown packet type. |
| A | Administratively unreachable. Usually, this output indicates that an access list is blocking traffic. |
| H | Host unreachable. |
| N | Network unreachable. |
| P | Protocol unreachable. |
| Q | Source quench. |
| U | Port unreachable. |

5.23.3 telnet

The **telnet** User EXEC command is used to log in to a host that supports Telnet.

Syntax

telnet *ip-address* | *hostname* [*port*] [*keyword1.....*]

- *ip-address* — IP address of the destination host. An out-of-band IP address can be specified as described in the usage guidelines. (Range: 1 - 160 characters)
- *host* — Hostname of the destination host (Range: Valid IP Address)
- *port* — A decimal TCP port number, or one of the keywords from the ports table in the usage guidelines. The default is the Telnet port (decimal23) on the host.
- *keyword* — Can be one or more keywords from the keywords table in the User Guidelines.

Default Configuration

This command has no default configuration.

Command Mode

User EXEC mode

User Guidelines

The Telnet software supports special Telnet commands in the form of Telnet sequences that map generic terminal control functions to operating system-specific functions. To issue a special Telnet command, enter Esc and then a command character.

If you want to login to host on the out-of-band port, use the out-of-band IP address format: oob/ip-address.

Special Telnet Command character

| Escape Sequence | Purpose |
|-----------------|------------------------|
| Ctrl-shift-6 b | Break |
| Ctrl-shift-6 c | Interrupt Process (IP) |
| Ctrl-shift-6 h | Erase Character (EC) |
| Ctrl-shift-6 o | Abort Output (AO) |
| Ctrl-shift-6 t | Are You There? (AYT) |
| Ctrl-shift-6 u | Erase Line (EL) |

At any time during an active Telnet session, the Telnet commands can be listed by pressing the Ctrl-shift-6 key, followed by a question mark at the system prompt: Ctrl-shift-6 ?

A sample of this list follows.

The following example displays the system service tag information.

```

Console> 'Ctrl-shift-6' ?
[Special telnet escape help]
Esc B sends telnet BREAK
Esc C sends telnet IP
Esc H sends telnet EC
Esc O sends telnet AO
Esc T sends telnet AYT
Esc U sends telnet EL

```

Several concurrent Telnet sessions can be opened and switched between them. To open a subsequent session, the current connection needs to be suspended, by pressing the escape sequence 'Ctrl-Shift-6' and 'x' to return to the system command prompt. Then open a new connection with the telnet command.

If you want to login to host on the out-of-band port, use the out-of-band IP address format: oob/ip-address.

Keywords Table

| Options | Description |
|-------------------|---|
| /echo | Enables local echo |
| /quiet | Prevents onscreen display of all messages from the software |
| /source-interface | Specifies the source interface. |
| /stream | Turns on stream processing, which enables a raw TCP stream with no Telnet control sequences. A stream connection does not process Telnet options and can be appropriate for connections to ports running UNIX-to-UNIX Copy Program (UUCP) and other non-Telnet protocols. |

Ports Table

| Keyword | Description | Port number |
|---------|-------------------------|-------------|
| bgp | Border Gateway Protocol | 179 |
| chargen | Character generator | 19 |
| cmd | Remote commands | 514 |
| daytime | Daytime | 13 |
| discard | Discard | 9 |
| domain | Domain Name Service | 53 |
| echo | Echo | 7 |
| exec | Exec | 512 |
| finger | Finger | 79 |

| | | |
|-------------|---------------------------------|-----|
| ftp | File Transfer Protocol | 21 |
| ftp-data | FTP data connections | 20 |
| gopher | Gopher | 70 |
| hostname | NIC hostname server | 101 |
| ident | Ident Protocol | 113 |
| irc | Internet Relay Chat | 194 |
| klogin | Kerberos login | 543 |
| kshell | Kerberos shell | 544 |
| login | Login | 513 |
| lpd | Printer service | 515 |
| nntp | Network News Transport Protocol | 119 |
| pop2 | Post Office Protocol v2 | 109 |
| pop3 | Post Office Protocol v3 | 110 |
| pim-auto-rp | PIM Auto-RP | 496 |
| smtp | Simple Mail Transport Protocol | 25 |
| sunrpc | Sun Remote Procedure Call | 111 |
| syslog | Syslog | 514 |
| tacacs | TAC Access Control System | 49 |
| talk | Talk | 517 |
| telnet | Telnet | 23 |
| time | Time | 37 |
| uucp | Unix-to-Unix Copy Program | 540 |
| whois | Nickname | 43 |
| www | World Wide Web | 80 |

Example

```
Console> telnet 176.213.10.50
Esc U sends telnet EL
```

5.23.4 resume

The resume command in EXEC mode is used to switch to another open Telnet session.

Syntax

resume [*connection*]

- *connection* — The connection number. The default is the most recent connection

Default Configuration

There is no default configuration for this command.

Command Mode

EXEC mode

User Guidelines

There are no user guidelines for this command.

Examples

The following command switches to another open Telnet session.

```
Console> resume 176.213.10.50
```

5.23.5 reload

The **reload** privileged EXEC command reloads the operating system.

Syntax

reload

Default Configuration

This command has no default configuration.

Command Mode

Privileged EXEC mode

User Guidelines

Caution should be exercised when resetting the device, to ensure that no other activity is being performed. In particular, the user should verify that no configuration files are being downloaded at the time of reset.

Example

The following example reloads the operating system.

```
Console# reload
```

5.23.6 hostname

The **hostname** global configuration command specifies or modifies the device host name. To remove the existing host name, use the **no** form of the command.

Syntax

hostname *name*

no hostname

- *name* — The device host name.

Default Configuration

This command has no default configuration.

Command Mode

Global Configuration mode

User Guidelines

There are no user guidelines for this command.

Example

The following example specifies the device host name.

```
Console (config)# hostname abc
```

5.23.7 show users

The **show users** user EXEC command displays information about the active users.

Syntax

show users

Default Configuration

This command has no default configuration.

Command Mode

User EXEC mode

User Guidelines

There are no user guidelines for this command.

Example

The following example displays information about the active users.

```

Console# show users
Username                Protocol                Location
-----                -
Bob                     Serial
John                    SSH                    172.16.0.1
Robert                  HTTP                    172.16.0.8

```

5.23.8 show sessions

The **show sessions** command in EXEC mode lists the open Telnet sessions.

Syntax

show sessions

This command has no arguments or keywords.

Default Configuration

There is no default configuration for this command.

Command Mode

EXEC mode

User Guidelines

There are no user guidelines for this command.

Examples

The following table describes the significant fields shown in the display:

```

Console> show sessions
Connection  Host                Address              Port                Byte
-----
1           Remote router      172.16.1.1          23                  89
2           172.16.1.2        172.16.1.2          23                  8

```

| Field | Description |
|------------|--|
| Connection | Connection number |
| Host | Remote host to which the device is connected through a Telnet session. |

| | |
|---------|---|
| Address | IP address of the remote host. |
| Port | Telnet TCP port number |
| Byte | Number of unread bytes for the user to see on the connection. |

5.23.9 show system

The **show system** user EXEC command displays system information.

Syntax

show system

Default Configuration

This command has no default configuration.

Command Mode

User EXEC mode

User Guidelines

There are no user guidelines for this command.

Example

The following example displays the system information.

```

console# show system

System Description:
System Up Time (days,hour:min:sec):      01,02:48:20
System Contact:
System Name:
System Location:
System MAC Address:                       00:03:6d:30:57:00
System Object ID:                         1.3.6.1.4.1.89.1.1

```

Temperature—Indicates the temperature at which the device is currently running. The device temperature is displayed in Celsius.

The device temperature threshold is 0 - 40 C (32 - 104F). The following table displays the temperature in Fahrenheit in increments of 5.

| Celsius | Fahrenheit |
|---------|------------|
| 0 | 32 |
| 5 | 41 |
| 10 | 50 |

| | |
|----|-----|
| 15 | 59 |
| 20 | 68 |
| 25 | 77 |
| 30 | 86 |
| 35 | 95 |
| 40 | 104 |

5.23.10 show version

The **show version** user EXEC command displays the system version information.

Syntax

show version

Default Configuration

This command has no default configuration.

Command Mode

User EXEC mode

User Guidelines

There are no user guidelines for this command.

Example

The following example displays a system version (this version number is only for demonstration purposes).

```
Console> show version
SW version x.x.x.xx (date xx-xxx-xxxx time 17:34:19)
Boot version x.x.x.xx (date xx-xxx-xxxx time 11:48:21)
HW version x.x.x
```

5.24 Syslog Commands

5.24.1 logging on

The **logging on** global configuration command controls error messages logging. This command sends debug or error messages to a logging process, which logs messages to designated locations asynchronously to the process that generated the messages. To disable the logging process, use the **no** form of this command.

Syntax

logging on

no logging on

Default Configuration

Logging is enabled.

Command Mode

Global Configuration mode

User Guidelines

The logging process controls the distribution of logging messages to the various destinations, such as the logging buffer, logging file, or syslog server. Logging on and off for these destinations can be individually configured using the **logging buffered**, **logging file**, and **logging** global configuration commands. However, if the **logging on** command is disabled, no messages are sent to these destinations. Only the console receives messages.

Example

The following example shows how logging is enabled.

```
Console (config)# logging on
```

5.24.2 logging

The **logging** global configuration command logs messages to a syslog server. To delete the syslog server with the specified address from the list of syslogs, use the **no** form of this command.

Syntax

logging *{ip-address}* [**port** *port*] [**severity** *level*] [**facility** *facility*] [**description** *text*]

no logging *{ip-address}*

- *ip-address* — IP address of the host to be used as a syslog server. An out-of-band IP address can be specified as described in the usage guidelines.
- *port* — Port number for syslog messages. If unspecified, the port number defaults to 514. (Range: 1 - 65535)
- **severity level** — Limits the logging of messages to the syslog servers to a specified level: **emergencies**, **alerts**, **critical**, **errors**, **warnings**, **notifications**, **informational** and **debugging**. If unspecified, the default level is **informational**.
- *facility* — The facility that is indicated in the message. Can be one of the following values: **local0**, **local1**, **local2**, **local3**, **local4**, **local5**, **local 6**, **local7**. If unspecified, the port number defaults to **local7**.
- *text* — Syslog server description, which can be up to 64 characters.

Default Configuration

As described in the field descriptions.

Command Mode

Global Configuration mode

User Guidelines

Multiple syslog servers can be used.

If no specific severity level is specified, the global values apply to each server.

To define a logging server on the out-of-band port, use the out-of-band IP address format —**oob/ip-address**.

Example

The following example configures messages with a "critical" severity level so that they are logged to a syslog server with an IP address 10.1.1.1.

```
Console (config)# logging 10.1.1.1 severity critical
```

5.24.3 logging console

The **logging console** global configuration command limits messages logged to the console based on severity. To disable logging to the console terminal, use the **no** form of this command.

Syntax

logging console *level*

no logging console

- *level* — Limits the logging of messages displayed on the console to a specified level: **emergencies, alerts, critical, errors, warnings, notifications, informational, debugging**.

Default Configuration

The default is **informational**.

Command Mode

Global Configuration mode

User Guidelines

There are no user guidelines for this command.

Example

The following example limits messages logged to the console based on severity level "errors".

```
Console (config)# logging console errors
```

5.24.4 logging buffered

The **logging buffered** global configuration command limits syslog messages displayed from an internal buffer based on severity. To cancel the buffer use, use the **no** form of this command.

Syntax

logging buffered *level*

no logging buffered

- *level* — Limits the message logging to a specified level buffer: **emergencies, alerts, critical, errors, warnings, notifications, informational, debugging.**

Default Configuration

The default level is **informational**.

Command Mode

Global Configuration mode

User Guidelines

All the syslog messages are logged to the internal buffer. This command limits the commands displayed to the user.

Example

The following example limits syslog messages displayed from an internal buffer based on the severity level "debugging".

```
Console (config)# logging buffered debugging
```

5.24.5 logging buffered size

The **logging buffered size** global configuration command changes the number of syslog messages stored in the internal buffer. To return the number of messages stored in the internal buffer to the default value, use the **no** form of this command.

Syntax

logging buffered size *number*

no logging buffered size

- *number* — Numeric value indicating the maximum number of messages stored in the history table. (Range: 20 - 400)

Default Configuration

The default number of messages is 200.

Command Mode

Global Configuration mode

User Guidelines

There are no user guidelines for this command.

Example

The following example changes the number of syslog messages stored in the internal buffer to 300.

```
Console (config)# logging buffered size 300
```

5.24.6 clear logging

The **clear logging** privileged EXEC command clears messages from the internal logging buffer.

Syntax

clear logging

Default Configuration

This command has no default configuration.

Command Mode

Privileged EXEC mode

User Guidelines

There are no user guidelines for this command.

Example

The following example clears messages from the internal syslog message logging buffer.

```
Console# clear logging
Clear logging buffer [y/n] y
```

5.24.7 logging file

The **logging file** global configuration command limits syslog messages sent to the logging file based on severity.

To cancel the buffer, use the **no** form of this command.

23.7.1 Syntax

logging file *level*

no logging file

- *level* — Limits the logging of messages to the buffer to a specified level: **emergencies, alerts, critical, errors, warnings, notifications, informational** and **debugging**.

Default Configuration

The default severity level is **errors**.

Command Mode

Global Configuration mode

User Guidelines

There are no user guidelines for this command.

Example

The following example limits syslog messages sent to the logging file based on the severity level "alerts".

```
Console (config)# logging file alerts
```

5.24.8 clear logging file

The **clear logging file** privileged EXEC command clears messages from the logging file.

Syntax

clear logging file

Default Configuration

This command has no default configuration.

Command Mode

Privileged EXEC mode

User Guidelines

There are no user guidelines for this command.

Example

The following example clears messages from the logging file.

```
Console# clear logging file
Clear Logging File [y/n] y
```

5.24.9 show logging

The **show logging** privileged EXEC command displays the state of logging and the syslog messages stored in the internal buffer.

Syntax

show logging

Default Configuration

This command has no default configuration.

Command Mode

Privileged EXEC mode

User Guidelines

There are no user guidelines for this command.

Example

The following example displays the state of logging and the syslog messages stored in the internal buffer.

```

Console # show logging
Logging is enabled.
Console logging: level debugging. Console Messages: 0 Dropped (severity).
Buffer logging: level debugging. Buffer Messages: 11 Logged, 200 Max.
File logging: level notifications. File Messages: 0 Dropped (severity).
Syslog server 192.180.2.27 logging: errors. Messages: 6 Dropped (severity).
Syslog server 192.180.2.28 logging: errors. Messages: 6 Dropped (severity).
OOB Syslog server 176.16.8.9 logging: errors. Messages: 6 Dropped (severity).
2 messages were not logged (resources)
Buffer log:
11-Aug-2002 15:41:43: %LINK-3-UPDOWN: Interface FastEthernet g0, changed state to up
11-Aug-2002 15:41:43: %LINK-3-UPDOWN: Interface Ethernet g0, changed state to up
11-Aug-2002 15:41:43: %LINK-3-UPDOWN: Interface Ethernet g1, changed state to up
11-Aug-2002 15:41:43: %LINK-3-UPDOWN: Interface Ethernet g2, changed state to up
11-Aug-2002 15:41:43: %LINK-3-UPDOWN: Interface Ethernet e3, changed state to up
11-Aug-2002 15:41:43: %SYS-5-CONFIG_I: Configured from memory by console 11-Aug-2002 15:41:39:
%LINEPROTO-5-UPDOWN: Line protocol on Interface FastEthernet g0, changed state to up
11-Aug-2002 15:41:39: %LINEPROTO-5-UPDOWN: Line protocol on Interface Ethernet g0, changed
state to down
11-Aug-2002 15:41:39: %LINEPROTO-5-UPDOWN: Line protocol on Interface Ethernet g1, changed

```

```

state to down
11-Aug-2002 15:41:39: %LINEPROTO-5-UPDOWN: Line protocol on Interface Ethernet g2, changed
state to down
11-Aug-2002 15:41:39: %LINEPROTO-5-UPDOWN: Line protocol on Interface Ethernet e3, changed
state to down

```

5.24.10 show logging file

The **show logging file** privileged EXEC command displays the state of logging and the syslog messages stored in the logging file.

Syntax

show logging file

Default Configuration

This command has no default configuration.

Command Mode

Privileged EXEC mode

User Guidelines

There are no user guidelines for this command.

Example

The following example displays the state of logging and the syslog messages stored in the logging file.

```

Console # show logging file
Logging is enabled.
Console logging: level debugging. Console Messages: 0 Dropped (severity).
Buffer logging: level debugging. Buffer Messages: 11 Logged, 200 Max.
File logging: level notifications. File Messages: 0 Dropped (severity).
Syslog server 192.180.2.27 logging: errors. Messages: 6 Dropped (severity).
Syslog server 192.180.2.28 logging: errors. Messages: 6 Dropped (severity).
2 messages were not logged (resources)
File log:
11-Aug-2002 15:41:43: %LINK-3-UPDOWN: Interface FastEthernet g0, changed state to up
11-Aug-2002 15:41:43: %LINK-3-UPDOWN: Interface Ethernet g0, changed state to up
11-Aug-2002 15:41:43: %LINK-3-UPDOWN: Interface Ethernet g1, changed state to up
11-Aug-2002 15:41:43: %LINK-3-UPDOWN: Interface Ethernet g2, changed state to up
11-Aug-2002 15:41:43: %LINK-3-UPDOWN: Interface Ethernet e3, changed state to up

```



```

11-Aug-2002 15:41:43: %SYS-5-CONFIG_I: Configured from memory by console
11-Aug-2002 15:41:39: %LINEPROTO-5-UPDOWN: Line protocol on Interface FastEthernet g0, changed
state to up
11-Aug-2002 15:41:39: %LINEPROTO-5-UPDOWN: Line protocol on Interface Ethernet g0, changed
state to down
11-Aug-2002 15:41:39: %LINEPROTO-5-UPDOWN: Line protocol on Interface Ethernet g1, changed
state to down
11-Aug-2002 15:41:39: %LINEPROTO-5-UPDOWN: Line protocol on Interface Ethernet g2, changed
state to down
11-Aug-2002 15:41:39: %LINEPROTO-5-UPDOWN: Line protocol on Interface Ethernet e3, changed
state to down

```

5.24.11 show syslog-servers

The show syslog-servers privileged EXEC command displays the syslog servers settings.

Syntax

show syslog-servers

Default Configuration

This command has no default configuration.

Command Mode

Privileged EXEC mode

User Guidelines

There are no user guidelines for this command.

Example

The following example displays the syslog server settings.

```

Console# show syslog-servers

```

| IP address | Port | Severity | Facility | Description |
|---------------|-------|---------------|----------|-------------|
| ----- | ----- | ----- | ----- | ----- |
| 192.180 | 14 | Informational | local | 7 |
| 192.180.2.285 | 14 | Warning | local | 7 |

5.25 TACACS Commands

5.25.1 tacacs-server host

The **tacacs-server host** command in global configuration mode specifies a TACACS+ host. To delete the specified name or address, use the **no** form of this command.

Syntax

tacacs-server host {*ip-address* | *hostname*} [**single-connection**] [**port** *port-number*] [**timeout** *timeout*] [**key** *keystring*]

[**source** *source*] [**priority** *priority*]

no tacacs-server host *ip-address*

- *ip-address* — Name or IP address of the host. An out-of-band IP address can be specified as described in the usage guidelines.
- *hostname* — Hostname of the tacacs server. (Range: 1 - 160 characters)
- **single-connection** — Specify single-connection. Rather than have the device open and close a TCP connection to the daemon each time it must communicate, the single-connection option maintains a single open connection between the device and the daemon.
- *port-number* — Specify a server port number. If unspecified, the port number defaults to 49. (Range: 0 - 65535)
- *timeout*—Specifies the timeout value in seconds. If no timeout value is specified, the global value is used. (Range: 1 - 1000)
- *key-string* — Specifies the authentication and encryption key for all TACACS communications between the device and the TACACS server. This key must match the encryption used on the TACACS daemon. If no key string value is specified, the global value is used. (Range: Up to 160 characters)
- *source* — Specifies the source IP address to use for the communication. If no source value is specified, the global value is used.
- *priority* — Determines the order in which the servers will be used, when 0 is the highest priority. If unspecified defaults to 0. (Range: 0 - 65535)

Default Configuration

No TACAS host is specified

Command Mode

Global Configuration mode

User Guidelines

Multiple **tacacs-server host** commands can be used to specify multiple hosts.

If no host-specific timeout, key or source values are specified, the global values apply to each host.

To define TACACS server on the out-of-band port, use the out-of-band IP address format: oob/ip-address.

Example

The following example specifies a TACACS+ host.

```
Console (config)# tacacs-server host 172.16.1.1
```

5.25.2 tacacs-server key

The **tacacs-server key** command in global configuration mode sets the authentication encryption key used for all TACACS+ communications between the device and the TACACS+ daemon. To disable the key, use the **no** form of this command.

Syntax

tacacs-server key *key-string*

no tacacs-server key

- *key-string* — Specifies the authentication and encryption key for all TACAS communications between the router and the TACACS server. This key must match the encryption used on the TACACS daemon. (Range: Up to 160 characters)

Default Configuration

Empty string

Command Mode

Global Configuration mode

User Guidelines

There are no user guidelines for this command.

Examples

The following example sets the authentication encryption key.

```
Console (config)# tacacs-server key abc-s
```

5.25.3 tacacs-server timeout

The **tacacs-server timeout** command in global configuration mode sets the timeout value. To restore the default, use the **no** form of this command.

Syntax

tacacs-server timeout *timeout*

no tacacs-server timeout

- *timeout* — Specifies the timeout value in seconds. (Range: 1 - 1000)

Default Configuration

5 seconds

Command Mode

Global Configuration mode

User Guidelines

There are no user guidelines for this command.

Examples

The following example sets the timeout value as 300.

```
Console (config)# tacacs-server timeout 300
```

5.25.4 tacacs-server source-ip

The **tacacs-server source-ip** command in global configuration mode specifies the source IP address that will be used for the communication with TACACS servers. To return to default, use the **no** form of this command.

Syntax

tacacs-server source-ip *source*

no tacacs-server-ip

- *source* — Specifies the source IP address. An out-of-band IP address can be specified as described in the usage guidelines. (Range: Valid IP Address)

Default Configuration

The IP address would be of the outgoing IP interface.

User Guidelines

To define an out-of-band IP address use the out-of-band IP address format: oob/ip-address.

Command Mode

Global Configuration mode

User Guidelines

There are no user guidelines for this command.

Examples

The following example specifies the source IP address.

```
Console (config)# tacacs-server source-ip 172.16.8.1
```

5.25.5 show tacacs

The **show tacacs** command in Privileged EXEC mode displays configuration and statistics for a TACACS+ server.

Syntax

show tacacs [*ip-address*]

- *ip-address* — Name or IP address of the host.

Default Configuration

This command has no default configuration.

Command Mode

Privileged EXEC mode

User Guidelines

There are no user guidelines for this command.

Examples

The following example displays configuration and statistic for a TACACS+server.

```

Console# show tacacs
IP address      Status      Port      Single      TimeOut
Source IP      Priority
                Connection
-----
172.16.1.1     Connected   49        No          Global
Global         1

Global values
-----
TimeOut: 3
Source IP: 172.16.8.1
OOB Source IP: 176.16.8.1
OOB TACACS servers
IP address      Status      Port      Single      TimeOut
Source IP      Priority
                Connection
-----

```

| | | | | |
|---------------------------|-----------|----|----|--------|
| ----- | ----- | | | |
| 172.16.1.1 | Connected | 49 | No | Global |
| Global | 1 | | | |
| Global values | | | | |
| ----- | | | | |
| TimeOut: 3 | | | | |
| Source IP: 172.16.8.1 | | | | |
| OOB Source IP: 176.16.8.1 | | | | |

5.26 User Interface Commands

5.26.1 enable

The **enable** user EXEC command enters the privileged EXEC mode.

Syntax

enable [*privilege-level*]

- *privilege-level* — Privilege level to enter the system. (Range: 1 - 15)

Default Configuration

The default privilege level is 15.

Command Mode

User EXEC mode

User Guidelines

There are no user guidelines for this command.

Example

The following example shows how to enter privileged mode:

```
Console> enable
enter password:
Console#
```

5.26.2 disable

The **disable** privileged EXEC command returns to User EXEC mode.

Syntax

disable [*privilege-level*]

- *privilege-level* — Privilege level to enter the system. (Range: 1 - 15)

Default Configuration

The default privilege level is 1.

Command Mode

Privileged EXEC mode

User Guidelines

There are no user guidelines for this command.

Example

The following example shows how to return to normal mode.

```
Console# disable
Console>
```

5.26.3 configure

The **configure** privileged EXEC command enters the global configuration mode.

Syntax

configure

There are no parameters for this command.

Default Configuration

This command has no default configuration.

Command Mode

Privileged EXEC mode

User Guidelines

There are no user guidelines for this command.

Example

In the following example, because no keyword is entered, a prompt is displayed. After the keyword is selected, a message

confirming the command entry method is displayed.

```
Console# configure  
Console (config)#
```

5.26.4 login

The **login** user EXEC command changes a login username.

Syntax

login

Default Configuration

This command has no default configuration.

Command Mode

User EXEC mode

User Guidelines

There are no user guidelines for this command.

Example

The following example shows how to enter privileged EXEC mode and login.

```
Console> login  
User Name:admin  
Password:* * * * *  
  
Console#
```

5.26.5 exit(configuration)

The **exit** command exits any configuration mode to the next highest mode in the CLI mode hierarchy.

Syntax

exit

Default Configuration

This command has no default configuration.

Command Mode

All command modes

User Guidelines

There are no user guidelines for this command.

Example

The following example changes the configuration mode from Interface Configuration mode to User EXEC mode.

```
Console(config-if)# exit
Console(config)# exit
Console#
```

5.26.6 exit(EXEC)

The **exit** user EXEC command closes an active terminal session by logging off the device.

Syntax

exit

Default Configuration

This command has no default configuration.

Command Mode

User EXEC command mode

User Guidelines

There are no user guidelines for this command.

Example

The following example closes an active terminal session.

```
Console> exit
```

5.26.7 end

The **end** global configuration command ends the current configuration session and returns to the privileged command mode.

Syntax

end

Default Configuration

This command has no default configuration.

Command Mode

All Command modes

User Guidelines

There are no user guidelines for this command.

Example

The following example ends the current configuration session and returns to the previous command mode.

```
Console (config)# end
Console #
```

5.26.8 help

The **help** command displays a brief description of the help system.

Syntax

help

Default Configuration

This command has no default configuration.

Command Mode

All Command modes

User Guidelines

There are no user guidelines for this command.

5.26.9 history

The **history** line configuration command enables the command history function. To disable the command history feature, use the **no** form of this command.

Syntax

history

no history

Default Configuration

The history function is enabled.

Command Mode

Line Configuration mode

User Guidelines

There are no user guidelines for this command.

Example

The following example enables the command history function for telnet.

```
Console (config)# line telnet
Console (config-line)# history
```

5.26.10 history size

The **history size** line configuration command changes the command history buffer size for a particular line. To reset the command history buffer size to the default, use the **no** form of this command.

Syntax

history size *number-of-commands*

no history size

- *number-of-commands*—Number of commands that the system records in its history buffer. (Range: 10 - 216)

Default Configuration

The default history buffer size is 10.

Command Mode

Line Configuration mode

User Guidelines

There are no user guidelines for this command.

Example

The following example changes the command history buffer size to 100 entries for a particular line.

```
Console (config-line)# history size 100
```

5.26.11 show history

The **show history** user EXEC command lists the commands entered in the current session.

Syntax

show history

Default Configuration

This command has no default configuration.

Command Mode

User EXEC command mode

User Guidelines

The commands are listed from the first to the latest command.

The buffer is kept unchanged when entering to configuration mode and returning back.

Example

The following example displays all the commands entered while in the current privileged EXEC mode.

```
Console# show history  
  
show version  
  
show clock  
  
show history
```

5.26.12 show privilege

The **show privilege** user EXEC command displays the current privilege level.

Syntax

show privilege

Default Configuration

This command has no default configuration.

Command Mode

User EXEC command mode

User Guidelines

There are no user guidelines for this command.

Example

The following example displays the current privilege level.

```
Console# show privilege
```

```
Current privilege level is 15
```

5.27 VLAN Commands

5.27.1 vlan database

The **vlan database** global configuration command enters the VLAN configuration mode.

Syntax

```
vlan database
```

Default Configuration

This command has no default configuration.

Command Mode

Global Configuration mode

User Guidelines

There are no user guidelines for this command.

Example

The following example enters the VLAN database mode.

```
Console (config)# vlan database  
Console (config-vlan)#
```

5.27.2 vlan

Use the **vlan** interface configuration (VLAN) command to create a VLAN. To delete a VLAN, use the **no** form of this command.

Syntax

```
vlan {vlan-range}
```

```
no vlan {vlan-range}
```

- *vlan-range* — A list of valid VLAN IDs to be added. List separate, non-consecutive VLAN IDs separated by commas (without spaces); use a hyphen to designate a range of IDs. (Range: 2 - 4063)

Default Configuration

This command has no default configuration.

Command Mode

VLAN Database mode

User Guidelines

There are no user guidelines for this command.

Example

The following example VLAN number 1972 is created.

```
Console (config)# vlan database  
Console (config-vlan)# vlan 1972
```

5.27.3 default-vlan disable

The **default-vlan disable** VLAN configuration command disables the default VLAN functionality. Use the **no** form of this command to enable the default VLAN functionality.

Syntax

default-vlan disable

no default-vlan disable

This command has no keywords or arguments.

Default Configuration

Enabled

Command Modes

Vlan configuration mode

User Guidelines

There are no user guidelines for this command.

Examples1

```
Console# vlan database  
Console(config-vlan)# default-vlan disable
```

5.27.4 interface vlan

The **interface vlan** global configuration command enters the interface configuration (VLAN) mode.

Syntax

interface vlan *vlan-id*

- *vlan-id* — The ID of an existing VLAN (excluding GVRP dynamic VLANs).

Default Configuration

This command has no default configuration.

Command Mode

Global Configuration mode

User Guidelines

There are no user guidelines for this command.

Example

The following example configures the VLAN 1 IP address of 131.108.1.27 and subnet mask 255.255.255.0.

```
Console (config)# interface vlan 1
Console (config-if)# ip address 131.108.1.27 255.255.255.0
```

5.27.5 interface range vlan

The **interface range vlan** global configuration command enters the interface configuration mode to configure multiple VLANs.

Syntax

interface range vlan {*vlan-range* | **all**}

- *vlan-range* — A list of valid VLAN IDs to add. Separate non consecutive VLAN IDs with a comma and no spaces; a hyphen designates a range of IDs.
- **all** — All existing static VLANs.

Default Configuration

This command has no default configuration.

Command Mode

Global Configuration mode

User Guidelines

Commands under the interface range context are executed independently on each interface in the range. If the command returns an error on one of the interfaces, an error message is displayed and execution continues on other interfaces.

Example

The following example groups VLAN 221 until 228 and VLAN 889 to receive the same command.

```
Console (config)# interface range vlan 221-228,889
Console (config-if)#
```

5.27.6 name

The **name** interface configuration command adds a name to a VLAN. To remove the VLAN name use the **no** form of this command.

Syntax

name *string*

no name

- *string* — Unique name, up to 32 characters in length, to be associated with this VLAN.

Default Configuration

No name is defined.

Command Mode

Interface Configuration (VLAN) mode

User Guidelines

The VLAN name should be unique.

Example

The following example names VLAN number 19 with the name "Marketing".

```
Console (config)# interface vlan 19
Console (config-if)# name Marketing
```

5.27.7 switchport mode

The **switchport mode** interface configuration command configures the VLAN membership mode of a port. To reset the mode to the appropriate default for the device, use the **no** form of this command.

Syntax

switchport mode {access | trunk | general}

no switchport mode

- **access** — Port belongs to a single, untagged VLAN.
- **trunk** — Port belongs to 1..4063 VLANs, all tagged (except, optionally, for a single native VLAN).
- **general** — Port belongs to 1..4063 VLANs, and each VLAN is explicitly set by the user as tagged or untagged (full 802.1Q mode).

Default Configuration

All ports are in access mode, and belong to the default VLAN (whose VID=1).

Command Mode

Interface Configuration (Ethernet, port-channel) mode

User Guidelines

There are no user guidelines for this command.

Example

The following example configures e8 as an untagged layer 2 VLAN interface.

```
Console (config)# interface ethernet e8
Console (config-if)# switchport mode access
```

5.27.8 switchport access vlan

The **switchport access vlan** interface configuration command configures the VLAN ID when the interface is in access mode.

To reconfigure the default, use the **no** form of this command.

Syntax

switchport access vlan *vlan-id*

no switchport access vlan

- *vlan-id* — VLAN ID of the VLAN to which the port is configured.

Default Configuration

VLAN ID=1

Command Mode

Interface configuration (Ethernet, port-channel) mode

User Guidelines

The command automatically removes the port from the previous VLAN, and adds it to the new VLAN.

Example

The following example configures a VLAN ID of 23 to the untagged layer 2 VLAN interface number e8.

```
Console (config)# interface ethernet e8
Console (config-if)# switchport access vlan 23
```

5.27.9 switchport trunk allowed vlan

The **switchport trunk allowed vlan** interface configuration command adds or removes VLANs from a trunk port.

Syntax

switchport trunk allowed vlan {**add** *vlan-list* | **remove** *vlan-list*}

- **add** *vlan-list* — List of VLAN IDs to add. Separate non consecutive VLAN IDs with a comma and no spaces. A hyphen designates a range of IDs.
- **remove** *vlan-list* — List of VLAN IDs to remove. Separate non consecutive VLAN IDs with a comma and no spaces. A hyphen designate a range of IDs.

Default Configuration

This command has no default configuration.

Command Mode

Interface Configuration (Ethernet, port-channel) mode

User Guidelines

There are no user guidelines for this command.

Example

The following example shows how to add VLANs 2 and 5 to 8 to the allowed list of e8.

```
Console (config)# interface ethernet e8
Console (config-if)# switchport trunk allowed vlan add 2,5-8
```

5.27.10 switchport trunk native vlan

The **switchport trunk native vlan** interface configuration command defines the port as a member of the specified VLAN, and the VLAN ID as the "port default VLAN ID (PVID)". To configure the default VLAN ID, use the **no** form of this command.

Syntax

switchport trunk native vlan *vlan-id*

no switchport trunk native vlan

- *vlan-id* — Valid VLAN ID of the active VLAN.

Default Configuration

VLAN ID=1

Command Mode

Interface Configuration (Ethernet, port-channel) mode

User Guidelines

This command has the following consequences: incoming untagged frames are assigned to this VLAN and outgoing traffic in this VLAN on this port is sent untagged (despite the normal situation where traffic sent from a trunkmode port is all tagged).

The command adds the port as a member in the VLAN. If the port is already a member in the VLAN (not as a native), it should be first removed from the VLAN.

Example

The following example e8, in trunk mode, is configured to use VLAN number 123 as the "native" VLAN.

```
Console (config)# interface ethernet e8
Console (config-if)# switchport trunk native vlan 123
```

5.27.11 switchport general allowed vlan

The **switchport general allowed vlan** interface configuration command adds or removes VLANs from a general port.

Syntax

switchport general allowed vlan add *vlan-list* [**tagged** | **untagged**]

switchport general allowed vlan remove *vlan-list*

- **add** *vlan-list* — List of VLAN IDs to add. Separate non consecutive VLAN IDs with a comma and no spaces. A hyphen designates a range of IDs.
- **remove** *vlan-list* — List of VLAN IDs to remove. Separate non consecutive VLAN IDs with a comma and no spaces. A hyphen designates a range of IDs.

- **tagged** — Sets the port to transmit tagged packets for the VLANs. If the port is added to a VLAN without specifying tagged or untagged the default is tagged.
- **untagged** — Sets the port to transmit untagged packets for the VLANs.

Default Configuration

This command has no default configuration.

Command Mode

Interface Configuration (Ethernet, port-channel) mode

User Guidelines

There are no user guidelines for this command.

Example

The following example shows how to add VLANs 2, 5, and 6 to the allowed list.

```
Console (config)# interface ethernet e8
Console (config-if)# switchport general allowed vlan add 2,5,6 tagged
```

5.27.12 switchport general pvid

The **switchport general pvid** interface configuration command configures the PVID when the interface is in general mode. To configure the default value, use the **no** form of this command.

Syntax

switchport general pvid *vlan-id*

no switchport general pvid

- *vlan-id* — PVID (Port VLAN ID). The *vlan-id* may belong to a non-existent VLAN.

Default Configuration

VLAN ID=1

Command Mode

Interface configuration (Ethernet, port-channel) mode

User Guidelines

There are no user guidelines for this command.

Example

The following example shows how to configure the PVID for e8, when the interface is in general mode.

```
Console (config)# interface ethernet e8
Console (config-if)# switchport general pvid 234
```

5.27.13 switchport general ingress-filtering disable

The **switchport general ingress-filtering disable** interface configuration command disables port ingress filtering.

To enable ingress filtering on a port, use the **no** form of this command.

Syntax

switchport general ingress-filtering disable

no switchport general ingress-filtering disable

Default Configuration

Ingress filtering is enabled.

Command Mode

Interface Configuration (Ethernet, port-channel) mode

User Guidelines

There are no user guidelines for this command.

Example

The following example shows how to enables port ingress filtering on e8.

```
Console (config)# interface ethernet e8
Console (config-if)# switchport general ingress-filtering disable
```

5.27.14 switchport general acceptable-frame-type taggedonly

The **switchport general acceptable-frame-type tagged-only** interface configuration command discards untagged frames at ingress. To enable untagged frames at ingress, use the **no** form of this command.

Syntax

switchport general acceptable-frame-type tagged-only

no switchport general acceptable-frame-type tagged-only

Default Configuration

All frame types are accepted at ingress.

Command Mode

Interface Configuration (Ethernet, port-channel) mode

User Guidelines

There are no user guidelines for this command.

Example

The following example configures e8 to discard untagged frames at ingress.

```
Console (config)# interface ethernet e8
Console (config-if)# switchport general acceptable-frame-type tagged-only
```

5.27.15 switchport forbidden vlan

The **switchport forbidden vlan** interface configuration command forbids adding specific VLANs to a port. This may be used to prevent GVRP from automatically making these VLANs active on the selected ports. To revert to allowing the addition of specific VLANs to the port, use the **remove** parameter for this command.

Syntax

switchport forbidden vlan {**add** *vlan-list* | **remove** *vlan-list*}

- **add** *vlan-list* — List of VLAN IDs to add to the "forbidden" list. Separate non consecutive VLAN IDs with a comma and no spaces. A hyphen designates a range of IDs.
- **remove** *vlan-list* — List of VLAN IDs to remove from the "forbidden" list. Separate non consecutive VLAN IDs with a comma and no spaces. A hyphen designates a range of IDs.

Default Configuration

All VLANs allowed.

Command Mode

Interface Configuration (Ethernet, port-channel) mode

User Guidelines

There are no user guidelines for this command.

Example

The following example forbids adding VLANs number 234 till 256, to e8.

```

Console (config)# interface ethernet e8
Console (config-if)# switchport forbidden vlan add 234-256

```

5.27.16 map protocol protocols-group

The **map protocol protocols-group** VLAN database command adds a special protocol to a named group of protocols, which may be used for protocol-based VLAN assignment. To delete a protocol from a group, use the **no** form of this command.

Syntax

map protocol *protocol* [*encapsulation*] **protocols-group** *group*

no map protocol *protocol* *encapsulation*

- *protocol* — The protocol is a protocol number or one of the reserved names. The format is Hex format.
- *encapsulation* — One of the following values: **ethernet**, **rfc1042**, **llcOther**. If no option is indicated the default is **ethernet**.
- *group* — Group number of group of protocols associated together. (Range: 1 - 2147483647)

Default Configuration

This command has no default configuration.

Command Mode

VLAN Database mode

User Guidelines

The following protocol names are reserved:

ip-arp

ipx

Example

The following example maps protocol ip-arp to the group named "213".

```

Console (config)# vlan database
Console (config-vlan)# map protocol ip-arp protocols-group 213

```

5.27.17 switchport general map protocols-group vlan

The **switchport general map protocols-group vlan** interface configuration command sets a protocol-based classification rule. To delete a classification, use the **no** form of this command.

Syntax

switchport general map protocols-group *group* **vlan** *vlan-id*

no switchport general map protocols-group *group*

- *group* — Group number as defined in the **map protocol protocols-group** command. (Range: 1 - 2147483647)
- *vlan-id* — Define the VLAN ID in the classifying rule.

Default Configuration

This command has no default configuration.

Command Mode

Interface Configuration (Ethernet, port-channel) mode

User Guidelines

There are no user guidelines for this command.

Example

The following example sets a protocol-based classification rule of protocol group 1 to VLAN 8.

```
Console (config)# interface ethernet e8
Console (config-if)# switchport general map protocols-group 1 vlan 8
```

5.27.18 ip internal-usage-vlan

The **ip internal-usage-vlan** interface configuration command reserves a VLAN as the internal usage VLAN of an interface. Use the **no** form of this command to reset to default.

Syntax

ip internal-usage-vlan *vlan-id*

no ip internal-usage-vlan

- *vlan-id* — VLAN ID of the internal usage VLAN.(Range: Valid VLAN)

Default Configuration

This command has no default configuration.

Command Mode

Interface configuration (Ethernet, port-channel)

User Guidelines

An internal usage VLAN is required when an IP interface is defined on Ethernet port or Port-channel.

Using this command the user can define the internal usage VLAN of a port.

If an internal-usage is not defined for a Port, and the user wants to define an IP interface, the software chooses one of the unused VLANs.

If a VLAN ID was chosen by the software for internal usage, and the user wants to use that VLAN ID for static or dynamic VLAN, he should either remove the IP interface, creates the VLAN, and recreate the IP interface, or use this command to define explicit internal usage VLAN.

Examples

The following example reserves a VLAN as the internal usage VLAN of an interface..

```
Console (config)# ip internal-usage-vlan 10
```

5.27.19 show vlan

The **show vlan** privileged EXEC command displays VLAN information.

Syntax

```
show vlan [tag vlan-id | name vlan-name]
```

- *vlan-id* — A valid VLAN ID
- *vlan-name* — A valid VLAN name string. (Range: 1 - 32 characters)

Default Configuration

This command has no default configuration.

Command Mode

Privileged EXEC mode

User Guidelines

There are no user guidelines for this command.

Example

The following example displays all VLAN information.

```
console# show vlan
```

| Vlan | Name | Ports | Type | Authorization |
|------|--------|-------------------------|-----------|---------------|
| ---- | ----- | ----- | ----- | ----- |
| 1 | 1 | e(1,4-8),g(1-2),ch(1-8) | other | Required |
| 2 | VLAN_2 | e2 | permanent | Required |
| 3 | VLAN_3 | e3 | permanent | Required |

5.27.20 show vlan internal usage

The **show vlan internal usage** privileged EXEC command displays a list of VLANs being used internally by the switch.

Syntax

show vlan internal usage

Default Configuration

This command has no default configuration.

Command Mode

Privileged EXEC mode

User Guidelines

There are no user guidelines for this command.

Example

The following example displays all VLAN information.

```
Console# show vlan internal usage
```

| VLAN | Usage | IP Address | Reserved |
|-------|-------|------------|----------|
| ----- | ----- | ----- | ----- |
| 1007 | g1 | Active | No |
| 1008 | g2 | Inactive | Yes |
| 1009 | e3 | Active | Yes |

5.27.21 show interfaces switchport

The **show interfaces switchport** privileged EXEC command displays switchport configuration.

Syntax

show interfaces switchport {**ethernet** *interface* | **port-channel** *port-channel-number*}

- *interface* — Specific interface, such as ethernet e8.
- *port-channel-number* — Valid port-channel trunk index.

Default Configuration

This command has no default configuration.

Command Mode

Privileged EXEC mode

User Guidelines

There are no user guidelines for this command.

Example

The following example displays switchport configuration individually for e1.

```

Console> show interface switchport ethernet e1

Port e1:

Port mode: General

GVRP Status: disabled

Ingress Filtering: true

Acceptable Frame Type: admitAll

Ingress Untagged VLAN (NATIVE) : 1

Port is member in:

Vlan          Name                Egress rule        Type
-----
1             default             untagged            System
8             VLAN008             tagged              Dynamic
11            VLAN011             tagged              Static

Forbidden VLANs:

VLAN          Name
-----
73            Out
74

Classification rules:

Group ID      VLAN
-----

```

219

372

5.28 Web Server Commands

5.28.1 ip http server

The **ip http server** global configuration command enables the device to be configured from a browser. To disable this function use the **no** form of this command.

Syntax

ip http server

no ip http server

Default Configuration

This command has no default configuration.

Command Mode

Global Configuration mode

User Guidelines

There are no user guidelines for this command.

Example

The following example enables the device to be configured from a browser.

```
Console (enable)# ip http server
```

5.28.2 ip http port

The **ip http port** global configuration command specifies the TCP port for use by a web browser to configure the device. To use the default TCP port, use the **no** form of this command.

Syntax

ip http port *port-number*

no ip http port

- *port-number* — Port number for use by the HTTP server. (Range: 0 - 65535)

Default Configuration

This default port number is **80**.

Command Mode

Global Configuration mode

User Guidelines

There are no user guidelines for this command. However, specifying 0 as the port number will effectively disable HTTP access to the device.

Example

The following example shows how the http port number is configured to 100.

```
Console (config)# ip http port 100
```

5.28.3 ip https server

The **ip https server** global configuration command enables the device to be configured from a secured browser. To disable this function, use the **no** form of this command.

Syntax

ip https server

no ip https server

Default Configuration

The default for the device is disabled.

Command Mode

Global Configuration mode

User Guidelines

You must use the **crypto certificate generate** command to generate the HTTPS certificate.

Example

The following example enables the device to be configured from a browser.

```
Console (enable)# ip https server
```

5.28.4 ip https port

The **ip https port** global configuration command configures a TCP port for use by a secure web browser to configure the device. To use the default port, use the **no** form of this command.

Syntax

ip https port *port-number*

no ip https port

- *port-number* — Port number for use by the HTTP server. (Range: 0 - 65535)

Default Configuration

This default port number is 443.

Command Mode

Global Configuration mode

User Guidelines

There are no user guidelines for this command.

Example

The following example configures the https port number to 100.

```
Console (enable)# ip https port 100
```

5.28.5 crypto certificate generate

The **crypto certificate generate** global configuration command generates a HTTPS certificate.

Syntax

crypto certificate generate [**key-generate** [*length*]]

key-generate — Regenerate SSL RSA key.

- *length* — Specifies the SSL RSA key length. If unspecified, length defaults to 1024. (Range: 512 - 2048)

Default Configuration

The Certificate and the SSL RSA key pairs do not exist.

Command Mode

Global Configuration mode

User Guidelines

The command is not saved in the router configuration; however, the certificate and keys generated by this command are saved

in the private configuration, which is never displayed to the user or backed up to another device.

Example

The following example regenerates a HTTPS certificate.

```
Console (enable)# crypto certificate generate key-generate
```

5.28.6 show ip http

The **show ip http** privileged EXEC command displays the HTTP server configuration.

Syntax

```
show ip http
```

Default Configuration

This command has no default configuration.

Command Mode

Privileged EXEC command

User Guidelines

There are no user guidelines for this command.

Example

The following example displays the HTTP server configuration.

```
Console # show ip http  
  
HTTP server enable. Port: 80
```

5.28.7 show ip https

The **show ip https** privileged EXEC command displays the HTTPS server configuration.

Syntax

```
show ip https
```

Default Configuration

This command has no default configuration.

Command Mode

Privileged EXEC command

User Guidelines

There are no user guidelines for this command.

Example

The following example displays the HTTP server configuration.

```
Console# show ip https
HTTPS server enabled. Port: 443
Certificate was generated.
```

5.29 802.1x Commands

5.29.1 aaa authentication dot1x

The **aaa authentication dot1x** global configuration command specifies one or more authentication, authorization, and accounting (AAA) methods for use on interfaces running IEEE 802.1X. Use the **no** form of this command to return to default.

Syntax

aaa authentication dot1x default *method1* [*method2...*]

no aaa authentication dot1x default

- *method1* [*method2...*] — At least one from the following table:

| Keyword | Description |
|---------|--|
| Radius | Uses the list of all RADIUS servers for authentication |
| None | Uses no authentication |

Default Configuration

The default behavior of the "aaa authentication" for dot1.x is "failed to authenticate". If the 802.1x calls the AAA for authentication services it will receive a fail status.

Command Mode

Global configuration mode

User Guidelines

The additional methods of authentication are used only if the previous method returns an error, not if it fails. To ensure that the authentication succeeds even if all methods return an error, specify **none** as the final method in the command line.

Examples

The following example uses the **aaa authentication dot1x default** command with no authentication.

```
Console (config)# aaa authentication dot1x default none
```

5.29.2 dot1x system-auth-control

The dot1x system-auto-control command enables 802.1x globally. Use the **no** form of this command to disable 802.1x globally.

dot1x system-auto-control

no dot1x system-auto-control

Syntax

This command has no arguments or keywords.

Default Configuration

Disabled

Command Modes

Global configuration mode

User Guidelines

There are no user guidelines for this command.

Examples

The following example enables 802.1x globally.

```
Console (config)# dot1x system-auto-control
```

5.29.3 dot1x port-control

The **dot1x port-control** interface configuration command enables manual control of the authorization state of the port. Use the **no** form of this command to return to the default setting.

Syntax

dot1x port-control {auto | force-authorized | force-unauthorized}

no dot1x port-control

- **auto** — Enable 802.1X authentication on the interface and cause the port to transition to the authorized or unauthorized state based on the 802.1X authentication exchange between the switch and the client.

- **force-authorized** — Disable 802.1X authentication on the interface and cause the port to transition to the authorized state without any authentication exchange required. The port resends and receives normal traffic without 802.1X-based authentication of the client.
- **force-unauthorized** — Deny all access through this interface by forcing the port to transition to the unauthorized state, ignoring all attempts by the client to authenticate. The switch cannot provide authentication services to the client through the interface.

Default Configuration

force-authorized

Command Mode

Interface configuration (Ethernet)

User Guidelines

There are no user guidelines for this command.

Examples

The following example enables 802.1X authentication on the interface.

```
Console (config)# interface ethernet e8
Console (config-if)# dot1x port-control auto
```

5.29.4 dot1x re-authentication

The **dot1x re-authentication** interface configuration command enables periodic re-authentication of the client. Use the **no** form of this command to return to the default setting.

Syntax

dot1x re-authentication

no dot1x re-authentication

This command has no arguments or keywords.

Default Configuration

Periodic re-authentication is disabled.

Command Mode

Interface configuration (Ethernet)

User Guidelines

There are no user guidelines for this command.

Examples

The following example enables periodic re-authentication of the client.

```
Console (config)# interface ethernet e8
Console (config-if)# dot1x re-authentication
```

5.29.5 dot1x timeout re-authperiod

The **dot1x timeout re-authperiod** interface configuration command sets the number of seconds between reauthentication attempts. Use the **no** form of this command to return to the default setting.

Syntax

dot1x timeout re-authperiod *seconds*

no dot1x timeout re-authperiod

- *seconds* — Number of seconds between re-authentication attempts. (Range: 300 - 4294967295)

Default Configuration

3600

Command Mode

Interface configuration (Ethernet) mode

User Guidelines

There are no user guidelines for this command.

Examples

The following example sets the number of seconds between re-authentication attempts, to 3600.

```
Console (config)# interface ethernet e8
Console (config-if)# dot1x timeout re-authperiod 3600
```

5.29.6 dot1x re-authenticate

The **dot1x re-authenticate** privileged EXEC command manually initiates a re-authentication of all 802.1X-enabled ports or the specified 802.1X-enabled port.

dot1x re-authenticate [**ethernet** *interface*]

- *interface* — The full syntax is: *unit/port*.

Default Configuration

This command has no default configuration.

Command Mode

Privileged EXEC mode

User Guidelines

There are no user guidelines for this command.

Examples

The following command manually initiates a re-authentication of the 802.1X-enabled port.

```
Console (config)# dot1x re-authenticate ethernet e8
```

5.29.7 dot1x timeout quiet-period

The **dot1x timeout quiet-period** interface configuration command sets the number of seconds that the switch remains in the quiet state following a failed authentication exchange (for example, the client provided an invalid password). Use the **no** form of this command to return to the default setting.

Syntax

dot1x timeout quiet-period *seconds*

no dot1x timeout quiet-period

- *seconds* — Time in seconds that the switch remains in the quiet state following a failed authentication exchange with the client. (Range: 0 - 65535 seconds)

Default Configuration

60

Command Mode

Interface configuration (Ethernet)

User Guidelines

During the quiet period, the switch does not accept or initiate any authentication requests.

The default value of this command should only be changed to adjust for unusual circumstances, such as unreliable links or specific behavioral problems with certain clients and authentication servers.

If it is necessary to provide a faster response time to the user, a smaller number than the default should be entered.

Examples

The following example sets the number of seconds that the switch remains in the quiet state following a failed authentication

exchange, to 3600.

```
Console (config)# interface ethernet e8
Console (config-if)# dot1x timeout quiet-period 3600
```

5.29.8 dot1x timeout tx-period

The **dot1x timeout tx-period** interface configuration command sets the number of seconds that the switch waits for a response to an Extensible Authentication Protocol (EAP) - request/identity frame, from the client, before resending the request. Use the **no** form of this command to return to the default setting.

Syntax

dot1x timeout tx-period *seconds*

no dot1x timeout tx-period

- *seconds* — Time in seconds that the switch should wait for a response to an EAP -request/identity frame from the client before resending the request. (Range: 1 - 65535 seconds)

Default Configuration

30

Command Mode

Interface configuration (Ethernet)

Examples

The following command sets the number of seconds that the switch waits for a response to an EAP - request/identity frame, to 3600 seconds.

```
Console (config)# interface ethernet e8
Console (config-if)# dot1x timeout tx-period 3600
```

5.29.9 dot1x max-req

The **dot1x max-req** interface configuration command sets the maximum number of times that the switch sends an Extensible Authentication Protocol (EAP) - request/identity frame (assuming that no response is received) to the client, before restarting the authentication process. Use the **no** form of this command to return to the default setting.

Syntax

dot1x max-req *count*

no dot1x max-req

- *count* — Number of times that the switch sends an EAP - request/identity frame before restarting the authentication process. (Range: 1 - 10)

Default Configuration

2

Command Mode

Interface configuration (Ethernet) mode

User Guidelines

There are no user guidelines for this command.

Examples

The following example sets the number of times that the switch sends an EAP - request/identity frame, to 6

```
Console (config)# interface ethernet e8
Console (config-if)# dot1x max-req 6
```

5.29.10 dot1x timeout supp-timeout

The **dot1x timeout supp-timeout** interface configuration command sets the time for the retransmission of an Extensible Authentication Protocol (EAP)-request frame to the client. Use the **no** form of this command to return to the default setting.

Syntax

dot1x timeout supp-timeout *seconds*

no dot1x timeout supp-timeout

- *seconds* — Time in seconds that the switch should wait for a response to an EAP-request frame from the client before resending the request. (Range: 1 - 65535 seconds)

Default Configuration

30

Command Mode

Interface configuration (Ethernet) mode

User Guidelines

The default value of this command should be changed only to adjust to unusual circumstances, such as unreliable links or specific behavioral problems with certain clients and authentication servers.

Examples

The following example sets the time for the retransmission of an EAP-request frame to the client, to 3600 seconds.

```
Console (config)# dot1x timeout server-timeout 3600
```

5.29.11 dot1x timeout server-timeout

The **dot1x timeout server-timeout** interface configuration command sets the time for the retransmission of packets to the authentication server. Use the **no** form of this command to return to the default setting.

Syntax

dot1x timeout server-timeout *seconds*

no dot1x timeout server-timeout

- *seconds* — Time in seconds that the switch should wait for a response from the authentication server before resending the request. (Range: 1 - 65535 seconds)

Default Configuration

30

Command Mode

Interface configuration (Ethernet) mode

User Guidelines

There are no user guidelines for this command.

Examples

The following example sets the time for the retransmission of packets to the authentication server, to 3600 seconds.

```
console config-if(Config-VLAN)# dot1x timeout supp-timeout 3600
```

5.29.12 show dot1x

The **show dot1x** privileged EXEC command displays 802.1X status for the switch or for the specified interface.

Syntax

show dot1x [**ethernet** *interface*]

- *interface* —The full syntax is: *unit/port*.

Default Configuration

This command has no default configuration.

Command Mode

Privileged EXEC mode

User Guidelines

There are no user guidelines for this command.

Examples

The following example displays 802.1X status for the switch.

```
console# show dot1x
```

802.1x is disabled

| Port | Admin Mode | Oper Mode | Reauth Control | Reauth Period | Username |
|------|------------------|-------------|----------------|---------------|----------|
| e1 | Force Authorized | Authorized* | Disabled | 3600 | n/a |
| e2 | Force Authorized | Authorized* | Disabled | 3600 | n/a |
| e3 | Force Authorized | Authorized* | Disabled | 3600 | n/a |
| e4 | Force Authorized | Authorized* | Disabled | 3600 | n/a |
| e5 | Force Authorized | Authorized | Disabled | 3600 | n/a |
| e6 | Force Authorized | Authorized* | Disabled | 3600 | n/a |
| e7 | Force Authorized | Authorized* | Disabled | 3600 | n/a |
| e8 | Force Authorized | Authorized* | Disabled | 3600 | n/a |
| g1 | Force Authorized | Authorized* | Disabled | 3600 | n/a |
| g2 | Force Authorized | Authorized* | Disabled | 3600 | n/a |

* Port is down or not present

```

Console# show dot1x ethernet e3

Interface      Admin Mode      Oper Mode      Reauth
Reauth        Username
              Control        Period
1/e3           Auto           Unauthorized   Ena
3600           Clark
State: held
Quiet period: 60
Tx period: 30
Max req: 2
Login Time: n/a
Last Authentication: n/a
MAC Address: 0008.7832.9878
Authentication Method: Remote
Termination Cause: Supplicant logoff
    
```

The following table describes the significant fields shown in the display:

| Field | Description |
|----------------|--|
| Interface | The interface number. |
| Admin mode | The admin mode of the port. Possible values are: Force-auth, Force-unauth, Auto |
| Oper mode | The oper mode of the port. Possible values are: Authorized, Unauthorized. |
| Reauth Control | Reauthentication control. |
| Reauth Period | Reauthentication period. |
| Username | The User-Name representing the identity of the Supplicant. |
| State | The current value of the Authenticator PAE state machine. |
| Quiet period | The number of seconds that the switch remains in the quiet state following a failed authentication exchange (for example, the client provided an invalid password). |
| Tx period | The number of seconds that the switch waits for a response to an Extensible Authentication Protocol (EAP)-request/identity frame from the client before resending the request. |
| Max req | The maximum number of times that the switch sends an Extensible Authentication Protocol (EAP)-request/identity frame (assuming that no response is received) to the client before restarting the authentication process. |
| Login Time | How long the user is logged in. |

| | |
|---------------------|---------------------------------|
| Last Authentication | Time since last authentication. |
| Mac address | The supplicant MAC address. |

5.29.13 show dot1x users

The **show dot1x users** privileged EXEC command displays 802.1X users for the switch.

Syntax

show dot1x users [**username** *username*]

- *username* — Supplicant username

Default Configuration

This command has no default configuration.

Command Mode

Privileged EXEC mode

User Guidelines

There are no user guidelines for this command.

Example

The following example displays 802.1X users.

```
console# show dot1x users
```

| Username | Session Time | Last Auth | Auth Method | MAC Address |
|----------------|--------------|-----------|-------------|-------------|
| Interface | | | | |
| ----- | ----- | ----- | ----- | ----- |
| | | | | |
| Bob | 1d3h | | 58m | Remote |
| 0008.3b79.8787 | | 1/1 | | |
| John | 8h19m | | 2m | None |
| 0008.3b89.3127 | | 1/2 | | |

The following table describes the significant fields shown in the display:

| Field | Description |
|-----------------------|--|
| Username The | User-Name representing the identity of the Supplicant. |
| Login Time | How long the user is logged in. |
| Last Authentication | Time since last authentication. |
| Authentication Method | The authentication method used to establish the session. |
| Mac address | The supplicant MAC address. |
| Interface | The interface that the user is using. |

5.29.14 show dot1x statistics

The **show dot1x statistics** privileged EXEC command displays 802.1X statistics for the specified interface.

Syntax

show dot1x statistics ethernet *interface*

- *interface* — The full syntax is: *unit/port*.

Default Configuration

This command has no default configuration.

Command Mode

Privileged EXEC mode

User Guidelines

There are no user guidelines for this command.

Examples

The following example displays 802.1X statistics for the specified interface.

```
Switch# show dot1x statistics ethernet g1
```

```
EapolFramesRx: 11
```

```
EapolFramesTx: 12
```

```
EapolStartFramesRx: 1
```

```
EapolLogoffFramesRx: 1
```

```
EapolRespIIdFramesRx: 3
```

| |
|--------------------------------------|
| EapolRespFramesRx: 6 |
| EapolReqIdFramesTx: 3 |
| EapolReqFramesTx: 6 |
| InvalidEapolFramesRx: 0 |
| EapLengthErrorFramesRx: 0 |
| LastEapolFrameVersion: 1 |
| LastEapolFrameSource: 0008.3b79.8787 |

The following table describes the significant fields shown in the display:

| Field | Description |
|------------------------|--|
| EapolFramesRx | The number of valid EAPOL frames of any type that have been received by this Authenticator. |
| EapolFramesTx | The number of EAPOL frames of any type that have been transmitted by this Authenticator. |
| EapolStartFramesRx | The number of EAPOL Start frames that have been received by this Authenticator. |
| EapolLogoffFramesRx | The number of EAPOL Logoff frames that have been received by this Authenticator. |
| EapolRespIdFramesRx | The number of EAP Resp/Id frames that have been received by this Authenticator. |
| EapolRespFramesRx | The number of valid EAP Response frames (other than Resp/Id frames) that have been received by this Authenticator. |
| EapolReqIdFramesTx | The number of EAP Req/Id frames that have been transmitted by this Authenticator. |
| EapolReqFramesTx | The number of EAP Request frames (other than Rq/Id frames) that have been transmitted by this Authenticator. |
| InvalidEapolFramesRx | The number of EAPOL frames that have been received by this Authenticator in which the frame type is not recognized. |
| EapLengthErrorFramesRx | The number of EAPOL frames that have been received by this Authenticator in which the Packet Body Length field is invalid. |
| LastEapolFrameVersion | The protocol version number carried in the most recently received EAPOL frame. |
| LastEapolFrameSource | The source MAC address carried in the most recently received EAPOL frame. |

5.29.15 dot1x auth-not-req

The **dot1x auth-not-req** interface VLAN configuration command enables unauthorized users access to that VLAN. Use the **no** form of this command to disable the access.

Syntax

dot1x auth-not-req

no dot1x auth-not-req

This command has no arguments or keywords.

Default Configuration

User should be authorized to access the VLAN.

Command Mode

Interface configuration (VLAN) mode

User Guidelines

To define a VLAN for authorized and unauthorized users use the **dot1x auth-not-req** interface VLAN command.

Examples

The following example enables unauthorized users access to the VLAN.

```
console config-if(Config-VLAN)# dot1x auth-not-req
```

5.29.16 dot1x multiple-hosts

The **dot1x multiple-hosts** interface configuration command allows multiple hosts (clients) on an 802.1X-authorized port, that has the **dot1x port-control** interface configuration command set to **auto**. Use the **no** form of this command to return to the default setting.

dot1x multiple-hosts**no dot1x multiple-hosts**

This command has no arguments or keywords.

Default Configuration

Multiple hosts are disabled. If a port would join a port-channel, the state would be multiple hosts as long as the port is member in the port-channel.

Command Mode

Interface configuration (Ethernet) mode

User Guidelines

This command enables the attachment of multiple clients to a single 802.1X-enabled port. In this mode, only one of the attached hosts must be successfully authorized for all hosts to be granted network access. If the port becomes unauthorized, all attached clients are denied access to the network.

If a port would join a port-channel, the state would be multiple host as long as the port is member in the port-channel.

Examples

The following command allows multiple hosts (clients) on an 802.1X-authorized port.

```
console config-if(Config-VLAN)#dot1x multiple-hosts
```

5.29.17 dot1x single-host-violation

The **dot1x single-host-violation** interface configuration command configures the action to be taken, when a station whose MAC address is not the supplicant MAC address, attempts to access the interface. Use the **no** form of this command to return to default.

Syntax

dot1x single-host-violation {forward | discard | discard-shutdown} [trap *seconds*]

no port dot1x single-host-violation

- **forward** — Forward frames with source addresses not the supplicant address, but do not learn the address.
- **discard** — Discard frames with source addresses not the supplicant address.
- **discard-shutdown** — Discard frames with source addresses not the supplicant address. The port is also shutdown.
- **trap *seconds*** — Send SNMP traps, and specifies the minimum time between consecutive traps.(Range: 1- 1000000)

Default Configuration

Discard frames with source addresses not the supplicant address. No traps.

Command Mode

Interface configuration (Ethernet) mode

User Guidelines

The command is relevant when Multiple hosts is disabled and the user has been successfully authenticated

Examples

The following example uses the forward action to forward frames with source addresses.

```
console config-if(Config-VLAN)# dot1x single-host-violation forward trap 100
```

5.29.18 show dot1x advanced

The **show dot1x advanced** privileged EXEC command displays 802.1X advanced features for the switch or for the specified interface.

Syntax

show dot1x advanced [ethernet *interface*]

- *interface* — Ethernet interface

Default Configuration

This command has no default configuration.

Command Mode

Privileged EXEC mode

User Guidelines

There are no user guidelines for this command.

Examples

The following example displays 802.1X advanced features for the switch.

```
Switch# show dot1x advanced
Guest VLAN: 3978
Unauthenticated VLANs: 91, 92
Use user attributes from Authentication Server: Enabled
User VLAN not created: Create
Interface      Multiple
               Hosts
1/1            Disabled
1/2            Enabled
```

```
console# show dot1x advanced ethernet 1/1
Guest VLAN: 3978
Unauthenticated VLANs: 91, 92
Use user attributes from Authentication Server: Enabled
User VLAN not created: Create
Interface      Multiple
               Hosts
1/1            Disabled
1/2            Enabled
Single Host Violation: Discard
Trap: Enabled
Frequency: 100
Status: Authorized (Locked)
Counter: 9
```

TROUBLE SHOOTING

This chapter contains information to help you solve problems. If the Switch is not functioning properly, make sure the Ethernet Switch was set up according to instructions in this manual.

The Link LED is not lit

Solution:

Check the cable connection and remove duplex mode of the Switch.

Some stations cannot talk to other stations located on the other port

Solution:

Please check the VLAN, port trunking function that may introduce this kind of problem.

Performance is bad

Solution:

Check the full duplex status of the Ethernet Switch. If the Ethernet Switch is set to full duplex and the partner is set to half duplex, then the performance will be poor.

100Base-TX port link LED is lit, but the traffic is irregular

Solution:

Check that the attached device is not set to dedicate full duplex. Some devices use a physical or software switch to change duplex modes. Auto-negotiation may not recognize this type of full-duplex setting.

Why the Switch doesn't connect to the network

Solution:

Check the LNK/ACT LED on the switch .Try another port on the Switch. Make sure the cable is installed properly Make sure the cable is the right type Turn off the power. After a while, turn on power again.

How to deal forgotten password situation of Switch?

Solution:

1. Please contact Planet switch support team and the mail address is support_switch@planet.com.tw

APPENDIX A

A.1 Switch's RJ-45 Pin Assignments

When connecting your 10/100Mbps Ethernet Switch to another switch, a bridge or a hub, a straight or crossover cable is necessary. Each port of the Switch supports auto-MDI/MDI-X detection. That means you can directly connect the Switch to any Ethernet devices without making a crossover cable. The following table and diagram show the standard RJ-45 receptacle/connector and their pin assignments:

■ 10/100Mbps, 10/100Base-TX

| RJ-45 Connector pin assignment | | |
|--------------------------------|-------------------------------------|---|
| Contact | MDI Media Dependant Interface | MDI-X Media Dependant Interface-Cross |
| 1 | Tx + (transmit) | Rx + (receive) |
| 2 | Tx - (transmit) | Rx - (receive) |
| 3 | Rx + (receive) | Tx + (transmit) |
| 4, 5 | Not used | |
| 6 | Rx - (receive) | Tx - (transmit) |
| 7, 8 | Not used | |

■ 1000Mbps, 1000Base T

| RJ-45 Connector pin assignment | | |
|--------------------------------|--------|--------|
| Contact | MDI | MDI-X |
| 1 | BI_DA+ | BI_DB+ |
| 2 | BI_DA- | BI_DB- |
| 3 | BI_DB+ | BI_DA+ |
| 4 | BI_DC+ | BI_DD+ |
| 5 | BI_DC- | BI_DD- |
| 6 | BI_DB- | BI_DA- |
| 7 | BI_DD+ | BI_DC+ |
| 8 | BI_DD- | BI_DC- |

Implicit implementation of the crossover function within a twisted-pair cable, or at a wiring panel, while not expressly forbidden, is beyond the scope of this standard.

A.2 RJ-45 cable pin assignment

The standard cable, RJ-45 pin assignment

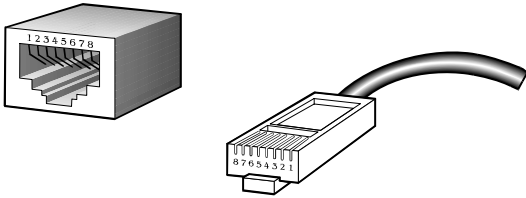

The standard RJ-45 receptacle/connector

There are 8 wires on a standard UTP/STP cable and each wire is color-coded. The following shows the pin allocation and color of straight cable and crossover cable connection:

| | | | | | | | | | |
|----------------|---|--------|--------|-------|---|---|---|--------------------|--------------------|
| Straight Cable | | SIDE 1 | SIDE 1 | SIDE2 | | | | | |
| 1 | 2 | 3 | 4 | 5 | 6 | 7 | 8 | 1 = White / Orange | 1 = White / Orange |
| 1 | 2 | 3 | 4 | 5 | 6 | 7 | 8 | 2 = Orange | 2 = Orange |
| 1 | 2 | 3 | 4 | 5 | 6 | 7 | 8 | 3 = White / Green | 3 = White / Green |
| 1 | 2 | 3 | 4 | 5 | 6 | 7 | 8 | 4 = Blue | 4 = Blue |
| 1 | 2 | 3 | 4 | 5 | 6 | 7 | 8 | 5 = White / Blue | 5 = White / Blue |
| 1 | 2 | 3 | 4 | 5 | 6 | 7 | 8 | 6 = Green | 6 = Green |
| 1 | 2 | 3 | 4 | 5 | 6 | 7 | 8 | 7 = White / Brown | 7 = White / Brown |
| 1 | 2 | 3 | 4 | 5 | 6 | 7 | 8 | 8 = Brown | 8 = Brown |
| | | SIDE 2 | SIDE 1 | SIDE2 | | | | | |
| 1 | 2 | 3 | 4 | 5 | 6 | 7 | 8 | 1 = White / Orange | 1 = White / Orange |
| 1 | 2 | 3 | 4 | 5 | 6 | 7 | 8 | 2 = Orange | 2 = Green |
| 1 | 2 | 3 | 4 | 5 | 6 | 7 | 8 | 3 = White / Green | 3 = White / Orange |
| 1 | 2 | 3 | 4 | 5 | 6 | 7 | 8 | 4 = Blue | 4 = Blue |
| 1 | 2 | 3 | 4 | 5 | 6 | 7 | 8 | 5 = White / Blue | 5 = White / Blue |
| 1 | 2 | 3 | 4 | 5 | 6 | 7 | 8 | 6 = Green | 6 = Orange |
| 1 | 2 | 3 | 4 | 5 | 6 | 7 | 8 | 7 = White / Brown | 7 = White / Brown |
| 1 | 2 | 3 | 4 | 5 | 6 | 7 | 8 | 8 = Brown | 8 = Brown |

Figure A-1: Straight-Through and Crossover Cable

Please make sure your connected cables are with same pin assignment and color as above picture before deploying the cables into your network.

A.3 Available Modules

The following list the available Modules for WGSW-24020/WGSW-48040

| | |
|-----------------|--|
| MGB-GT | SFP-port 1000Base-T Module |
| MGB-SX | SFP-port 1000Base-SX mini-GBIC module |
| MGB-LX | SFP-port 1000Base-LX mini-GBIC module |
| MGB-L50 | SFP-port 1000Base-LX mini-GBIC module-50KM |
| MGB-L70 | SFP-port 1000Base-LX mini-GBIC module-70KM |
| MGB-L120 | SFP-port 1000Base-LX mini-GBIC module-120KM |
| MGB-LA10 | SFP-port 1000Base-LX (WDM,TX:1310nm) mini-GBIC module-10KM |
| MGB-LB10 | SFP-port 1000Base-LX (WDM,TX:1550nm) mini-GBIC module-10KM |
| MGB-LA20 | SFP-port 1000Base-LX (WDM,TX:1310nm) mini-GBIC module-20KM |
| MGB-LB20 | SFP-port 1000Base-LX (WDM,TX:1550nm) mini-GBIC module-20KM |
| MGB-LA40 | SFP-port 1000Base-LX (WDM,TX:1310nm) mini-GBIC module-40KM |
| MGB-LB40 | SFP-port 1000Base-LX (WDM,TX:1550nm) mini-GBIC module-40KM |

2081-A34030-001

