

Industrial Ultra Power over Ethernet Splitter

IPOE-171S

User's Manual



Table of Contents

1. Package Contents	3
2. Product Features.....	4
3. Product Specifications	5
4. Hardware Introduction	8
4.1 Three-View Diagram	8
4.2 Product Front Panel	9
4.3 LED Indicators.....	10
5. Hardware Installation	11
5.1 Before Installation	11
5.2 4-pin Power Output Terminal Block.....	12
5.3 Wiring the Power Outputs.....	13
6. Customer Support	16

1. Package Contents

Thank you for purchasing PLANET Industrial Ultra Power over Ethernet Splitter, IPOE-171S. **“Ultra PoE Splitter”** mentioned in this manual refers to the IPOE-171S.

Open the box of the Ultra PoE Splitter and carefully unpack it. The box should contain the following items:

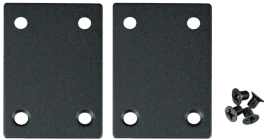
Ultra PoE Splitter x 1	User's Manual x 1
	
DIN Rail Kit	Wall-mount Kit
	

If any of these are missing or damaged, please contact your dealer immediately; if possible, retain the carton including the original packing material, and use them again to repack the product in case there is a need to return it to us for repair.

2. Product Features

Interface

- 2-Port RJ45 interfaces
 - 1-Port Data + Power input
 - 1-Port Data output
- 2 DC output (4-pin terminal block)
- 1 DC 12V/24V DIP switch

Power over Ethernet

- Complies with ultra Power over Ethernet end-span and mid-span PDs
- Complies with IEEE 802.3at Power over Ethernet Plus end-span/mid-span PD
- Supports PoE input power up to 110 watts
- Splits the 50~56V DC power over RJ45 Ethernet cable into DC 12V/24V output
- Remote power feeding up to 100 meters

Hardware

- IP30 metal case protection
- DIN rail and wall-mount design
- -40 to 75 degrees C operating temperature



Note

PSE (Power Sourcing Equipment) is a device (switch or hub for instance) that will provide power in a PoE setup. The maximum allowed continuous output power per such device in IEEE 802.3af is 15.4 watts, in IEEE 802.3at is 30 watts and in IEEE 802.3bt is 60 watts to 100watts.

PD (Powered Device) such as IP phones, network cameras, wireless access points, PoE extender or PoE splitters, is a PoE-enabled terminal that consumes energy supplied by PSE.

3. Product Specifications

Product		IPOE-171S
Hardware Specifications		
Interface	PoE Input Port	1 10/100/1000 BASE-T RJ45 "PoE (Data + Power) In"
	Data Output Port	1 10/100/1000 BASE-T RJ45 "Data Out"
	DC Out Plug Connector	1 removable 4-pin terminal block
	DIP Switch	12V DC/24V DC output voltage
LED Indicator	Power Ready	Green
	802.3at PoE+ In	Green
	Ultra PoE or 802.3bt PoE in	Green
	DC 12V	Orange
	DC 24V	Green
Network Cable	Ultra PoE (60W/75W/95)	4-pair UTP Cat5e, 6, up to 100m (328ft)
	802.3at PoE+	2-pair UTP Cat. 3, 4, 5, up to 100m (328ft)
Data Rate	10/100/1000Mbps	
Dimensions (W x D x H)	32 x 87 x 135 mm	
Weight	425g	
Installation	DIN rail/wall mountable	

Enclosure	IP30 metal case	
Power Requirements	50 ~ 56V DC PoE	
Power Output (at 56V DC Input)	12V DC, 4.5A (max.)	12V DC, 8A (max.) 24V DC, 4A (max.)
	24V DC, 2.3A (max.)	12V DC, 4.5A (max.) 24V DC, 2.3A (max.)
Power Consumption	System on with PoE input:	3.7 watts
	Ethernet full loading without DC output:	3.7 watts
	Full loading with maximum 12VDC, 4A output:	60.2 watts
	Full loading with maximum 12V DC, 8A output:	110 watts (110-watt PoE in)
Power over Ethernet		
PoE Standard	802.3bt Type 3/Type 4 Power over Ethernet, 4-pair 802.3at PoE+ and Cisco UPOE compliant with voltage within 50V-56V DC	

Power Output	DC 12V/24V by DIP switch control
PoE Power Supply Type	end-span + mid-span end-span mid-span
Power Pin Assignment	1/2 (+), 3/6 (-); 4/5 (+), 7/8 (-) or 1/2(-), 3/6(+); 4/5(+), 7/8(-)
Standards Conformance	
Standards Compliance	IEEE 802.3 10BASE-T Ethernet IEEE 802.3u 100BASE-TX Fast Ethernet IEEE 802.3ab 1000BASE-T Gigabit Ethernet IEEE 802.3at Power over Ethernet Plus IEEE 802.3af Power over Ethernet
Regulatory Compliance	FCC Part 15 Class A, CE
Environment	
Operating Temperature	-40 ~ 75 degrees C
Storage Temperature	-40 ~ 85 degrees C
Humidity	5 ~ 95% (non-condensing)

4. Hardware Introduction

4.1 Three-View Diagram

The three-view diagram of the **Ultra PoE Splitter** consists of one auto-sensing 10/100/1000BASE-T Ultra PoE In port, one auto-sensing 10/100/1000BASE-T **Data Out port** and one **removable 4-pin terminal block**. The LED Indicators are also located on the port of **Ultra PoE Splitter** front panel.

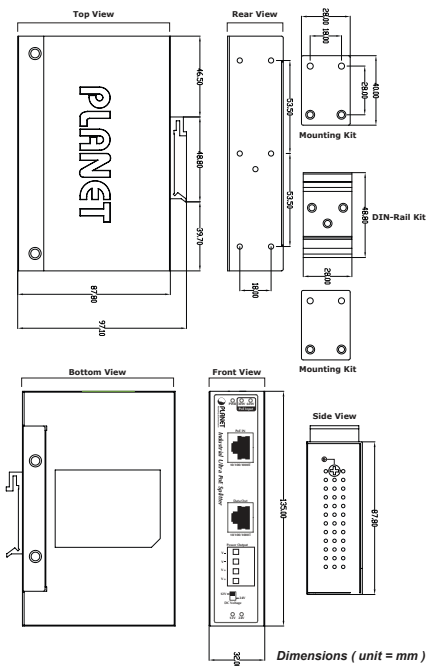

Figure 1: IPOE-171S Three-View Diagram

4.2 Product Front Panel

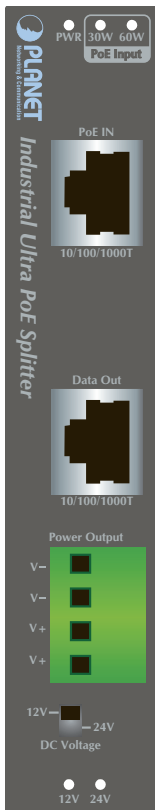

Figure 2: Front Panel of IPOE-171S

4.3 LED Indicators

PWR

LED	Color	Function
Power Ready	Green	Lights to indicate the port is receiving 50~57V DC in-line power and ready for output
30W	Green	Lights to indicate the ultra PoE splitter is working on 802.3at PoE mode
60W	Green	Lights to indicate the ultra PoE splitter is working on Ultra PoE or 802.3bt PoE in

DC Output voltage indicator

LED	Color	Function
12V	Orange	Lights to indicate the ultra PoE splitter's output is in 12V DC mode
24V	Green	Lights to indicate the ultra PoE splitter's output is in 24V DC mode

5. Hardware Installation

5.1 Before Installation

If there is no power socket in your network environment, the IPOE-171S provides DC power for this Ethernet Device conveniently and easily. The IPOE-171S will separate the power and data out. It provides two kinds of DC power output through its DIP switch and its voltage and current shown below:

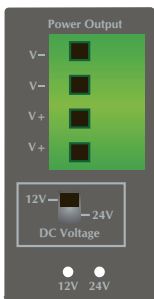

Figure 3: DIP Switch of IPOE-171S



- Please check the power requirements of the device carefully, that is going to get the power from IPOE-171S.
- If the power requirement is higher than the IPOE-171S can supply, current overload might shut down the IPOE-171S itself. Thus, it will also shut down your device as well.
- Please ensure the output voltage is correct for remote device. Otherwise, it will damage your remote device.



- Forbid to switch on/off the Power DIP during operation. Otherwise, it will damage your IPOE-171S and remote device. If you want to switch the output Voltage DIP, please Plug OUT the "POE In" cable and wait for 3 seconds until the POE LED (Power) is completely OFF.

5.2 4-pin Power Output Terminal Block

From top to down, there are Negative (V-), Negative (V-), Positive (V+) and Positive (V+), and two sets of DC power output contact.

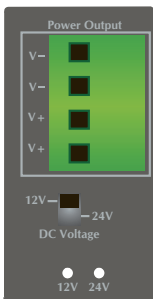

Figure 4: Terminal Block of IPOE-171S



Note

Two DC outputs are sharing 12V 8A or 24V 4A, **totaling 95 watts DC output power**, which means that DC1 + DC2 cannot be over the 95 watts DC output power. Otherwise, it might cause the power output to malfunction or damage.

5.3 Wiring the Power Outputs

Please follow the steps below to insert the power wires.

Step 1: Please find one terminal block connector within two DC power outputs shown below:

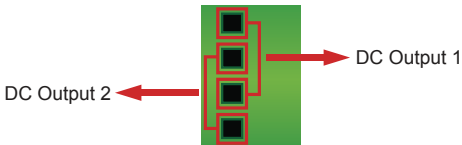

Note

The wire gauge for the terminal block should be in the range of 12 ~ 24 AWG.

Step 2: Insert the Negative/Positive DC wires into the V- / V+ terminal; terminals 1 and 3 for Power 1; terminals 2 and 4 for Power 2.

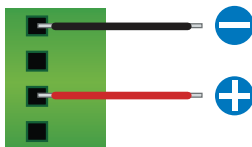

Step 3: Connect the other point of DC power wires to the power devices. Tighten the wire-clamp screws for preventing the wires from loosening.

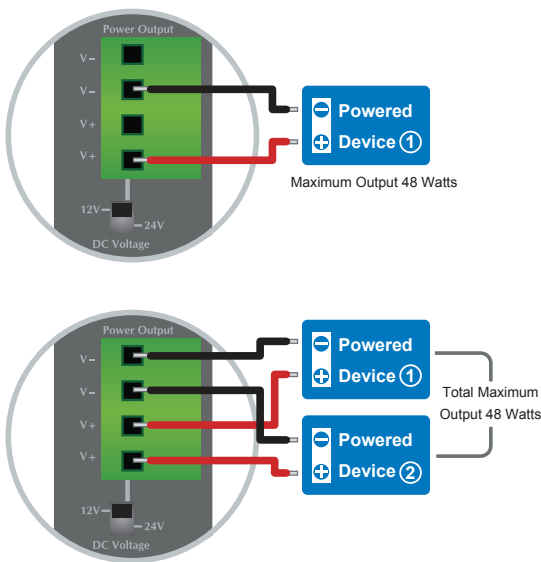

Step 4: Install the terminal block on PLANET IPOE-171S Splitter.

Step 5: Connect the network copper cable (RJ45) from the Ultra PoE PSE and it will provide power to PLANET IPOE-171S Splitter and it will separate the power and data to the PDs (power devices). Please see the figure below:

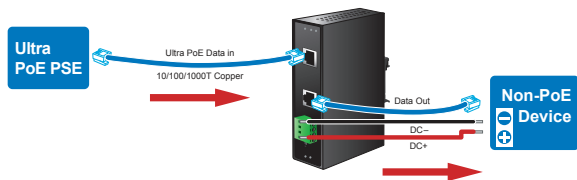

Please ensure the IPOE-171S output voltage is correct before applying power to remote device. The IPOE-171S provides DC 12V/24V power output.

7. Customer Support

Thank you for purchasing PLANET products. You can browse our online FAQ resource at PLANET web site first to check if it could solve your issue. If you need more support information, please contact PLANET switch support team.

PLANET online FAQ:

<http://www.planet.com.tw/en/support/faq.php?type=1>

Switch support team mail address:

support_switch@planet.com.tw

Copyright © PLANET Technology Corp. 2017.

Contents are subject to revision without prior notice.

PLANET is a registered trademark of PLANET Technology Corp. All other trademarks belong to their respective owners