

L3 24-Port 10/100/1000T 802.3bt PoE + 2-Port 10GBASE-T + 2-Port 10G SFP+ Managed Switch with LCD Touch Screen and Redundant Power

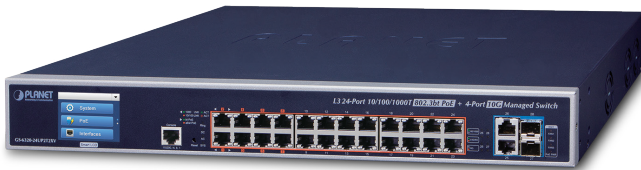

Powerful 802.3bt PoE Managed Switch with Advanced L2+/L4 Switching and Security

PLANET GS-6320-24UP2T2XV is a cost-optimized, **1.25U**, Gigabit 802.3bt PoE Managed Switch with **LCD Touch Screen** featuring PLANET intelligent PoE functions to improve the availability of critical business applications. It provides IPv6/IPv4 dual stack management and built-in L2+/L4 Gigabit switching engine along with **24 10/100/1000BASE-T 802.3bt PoE++ ports**, **2 10GBASE-T RJ45 ports** and **2 additional 10Gigabit SFP+ ports**. With a total power budget of up to 600 watts for different kinds of PoE applications, the GS-6320-24UP2T2XV provides a quick, safe and cost-effective 802.3bt PoE network solution for small businesses and enterprises.

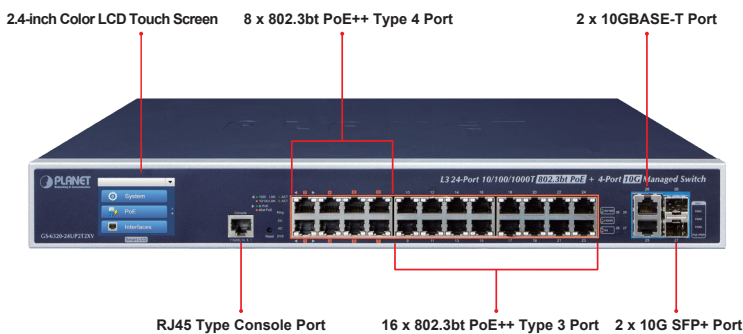

Physical Port

- **24 10/100/1000BASE-T** Gigabit RJ45 copper ports with 24-port **IEEE 802.3bt PoE++** injector function
- **2 10GBASE-T** RJ45 interfaces with auto MDI/MDI-X function
- **2 10GBASE-SR/LR SFP+ slots**, compatible with 1000BASE-SX/LX/BX SFP
- RJ45 console interface for switch basic management and setup

802.3bt Power over Ethernet

- Complies with IEEE 802.3bt Power over Ethernet Plus Plus
- Backward compatible with IEEE 802.3af /at Power over Ethernet
- Up to 24 ports of IEEE 802.3af/IEEE 802.3at/IEEE 802.3bt PoE devices powered
- 8 PoE ports with built-in 802.3bt PoE++ Type-4 90W injector function (Port-1 to Port-8)
- 16 PoE ports with built-in 802.3bt PoE++ Type-3 60W injector function (Port-9 to Port-24)
- Auto detects powered device (PD)
- Circuit protection prevents power interference between ports
- Remote power feeding up to 100 meters
- PoE management
 - Total PoE power budget control
 - Per port PoE function enable/disable
 - PoE admin-mode control
 - PoE port power feeding priority
 - Per PoE port power limitation
 - PD classification detection
 - Temperature threshold control
 - PD alive check
 - PoE schedule

Layer 2 Features

- Prevents packet loss with back pressure (half-duplex) and IEEE 802.3x pause frame flow control (full-duplex)
- High performance of Store-and-Forward architecture and runt/CRC filtering eliminates erroneous packets to optimize the network bandwidth
- Storm Control support
 - Broadcast/multicast/unknown unicast
- Supports VLAN
 - IEEE 802.1Q tagged VLAN
 - Up to 255 VLANs groups, out of 4094 VLAN IDs
 - Supports provider bridging (VLAN Q-in-Q, IEEE 802.1ad)
 - Private VLAN Edge (PVE)
 - Protocol-based VLAN

IEEE 802.3bt PoE solutions

The GS-6320-24UP2T2XV supports the 802.3bt standard, supplying up to 95 watts per port for increased requirements of devices. It can offer more PoE applications, such as:

- PoE PTZ speed dome cameras
- Any network device that needs higher PoE power to work normally
- Thin-client
- AIO (All-in-One) touch PC
- Remote digital signage display

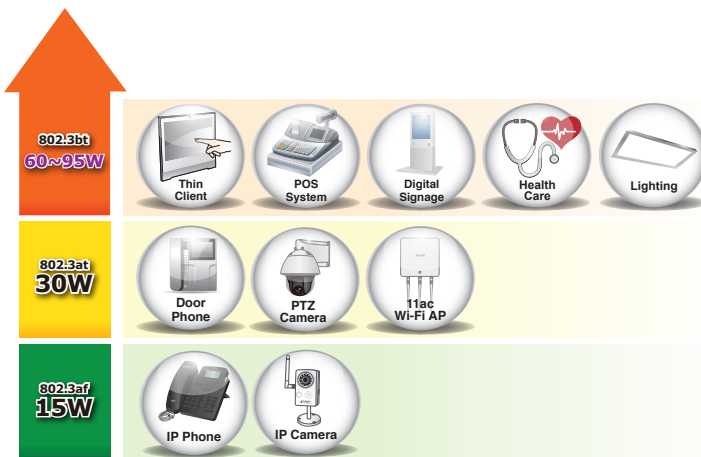

IEEE 802.3bt PoE solutions

The unique **Smart LCD PoE Switch** provides an intuitive touch panel on its front panel that facilitates the Ethernet management and PoE PD management. It greatly promotes management efficiency in large-scale networks, such as enterprises, hotels, shopping malls, government buildings, and other public areas, and features the following special management and status functions:

- IP address, VLAN and QoS configuration
- PoE management and status
- Port management and status/SFP information
- Troubleshooting: cable diagnostic and remote IP ping
- Maintenance: reboot, factory default and save configuration

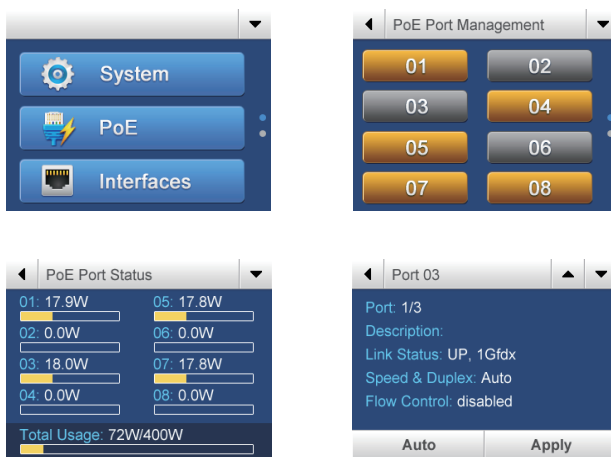

- MAC-based VLAN
- Voice VLAN
- GVRP (GARP VLAN Registration Protocol)
- Supports Spanning Tree Protocol
 - IEEE 802.1D Spanning Tree Protocol (STP)
 - IEEE 802.1w Rapid Spanning Tree Protocol (RSTP)
 - IEEE 802.1s Multiple Spanning Tree Protocol (MSTP), spanning tree by VLAN
 - BPDU Guard
- Supports Link Aggregation
 - 802.3ad Link Aggregation Control Protocol (LACP)
 - Cisco ether-channel (static trunk)
 - Maximum 26 trunk groups with 4 ports for each trunk group
 - Up to 80Gbps bandwidth (full duplex mode)
- Provides port mirror (many-to-1)
- Port mirroring to monitor the incoming or outgoing traffic on a particular port
- Loop protection to avoid broadcast loops
- Supports ERPS (Ethernet Ring Protection Switching)
- Compatible with Cisco uni-directional link detection(UDLD) that monitors a link between two switches and blocks the ports on both ends of the link if the link fails at any point between the two devices
- Link Layer Discovery Protocol (LLDP)

Layer 3 Features

- IP dynamic routing protocol supports OSPFv2
- IPv4/IPv6 hardware static routing
- Routing interface provides per VLAN routing mode
- IP interfaces (Max. 128 VLAN interfaces)
- Routing table (Max. 128 routing entries)

Quality of Service

- Ingress Shaper and Egress Rate Limit per port bandwidth control
- 8 priority queues on all switch ports
- Traffic classification
 - IEEE 802.1p CoS
 - TOS/DSCP/IP precedence of IPv4/IPv6 packets
 - IP TCP/UDP port number
 - Typical network application
- Strict priority and Weighted Round Robin (WRR) CoS policies
- Supports QoS and In/Out bandwidth control on each port
- Traffic-policing on the switch port
- DSCP remarking

Multicast

- Supports IPv4 IGMP snooping v1, v2 and v3
- Supports IPv6 MLD snooping v1 and v2
- Querier mode support
- IPv4 IGMP snooping port filtering
- IPv6 MLD snooping port filtering
- Multicast VLAN Registration (MVR) support

High Performance 10Gbps Ethernet Capacity

The GS-6320-24UP2T2XV offers wire-speed packets transfer performance without the risk of packet loss. The high data throughput of the device makes it ideal for most Gigabit environments. With a 20Gbps internal fabric and auto negotiation support in its 10 Gigabit port, the GS-6320-24UP2T2XV can handle extremely large amounts of data transmission in a secure topology linking to data center cloud computing, enterprise backbones, campus networks, and carrier infrastructure.

Convenient and Smart ONVIF Devices with Detection Feature

PLANET has newly developed an awesome feature -- ONVIF Support -- which is specifically designed for co-operating with Video IP Surveillances. From the GS-6320-24UP2T2XV GUI, clients just need one click to search and show all of the ONVIF devices via network application. In addition, clients can upload floor images to a switch and it allows you to deploy any surveillance devices for easier inspection and planning. Moreover, clients can get real-time surveillance's information and online/offline status, and also allows PoE reboot control from GUI.

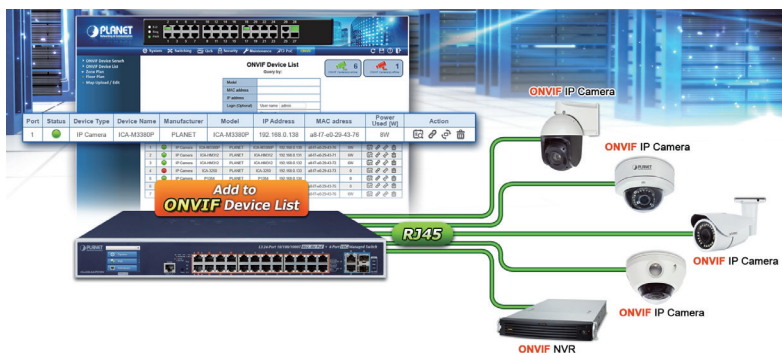
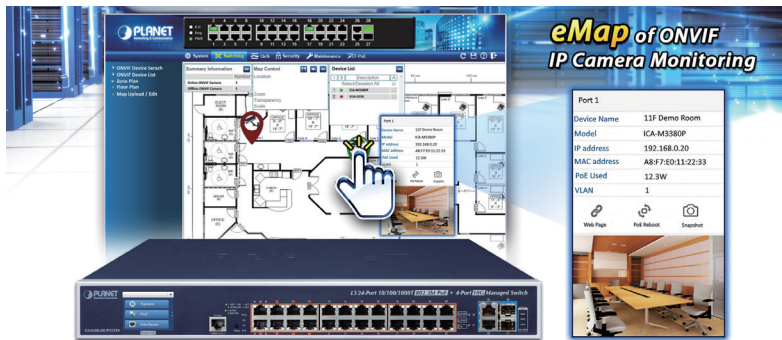

Built-in Unique PoE Functions for Powered Devices Management

Being the managed PoE switches for surveillance, wireless and VoIP networks, the GS-6320-24UP2T2XV features the following special PoE management functions:

- PD alive check
- Scheduled power recycling
- PoE schedule
- PoE usage monitoring

Intelligent Powered Device Alive Check

The GS-6320-24UP2T2XV can be configured to monitor connected PD (powered device) status in real time via ping action. Once the PD stops working and responding, the GS-6320-24UP2T2XV will resume the PoE port power and bring the PD back to work. It will greatly enhance the network reliability through the PoE port resetting the PD's power source and reducing administrator management burden.

Security

- Authentication
 - IEEE 802.1x port-based/MAC-based network access authentication
 - Built-in RADIUS client to cooperate with the RADIUS servers
 - TACACS+ login users access authentication
 - RADIUS/TACACS+ users access authentication
- Access Control List
 - IP-based Access Control List (ACL)
 - MAC-based Access Control List
- Source MAC/IP address binding
- DHCP Snooping to filter untrusted DHCP messages
- Dynamic ARP Inspection discards ARP packets with invalid MAC address to IP address binding
- IP Source Guard prevents IP spoofing attacks
- IP address access management to prevent unauthorized intruder

Management

- IPv4 and IPv6 dual stack management
- Switch Management Interfaces
 - Console/Telnet Command Line Interface
 - Web switch management
 - SNMP v1, v2c, and v3 switch management
 - SSH, TLS, SSL and SNMP v3 secure access
- SNMP Management
 - Four RMON groups (history, statistics, alarms and events)
 - SNMP trap for interface Link Up and Link Down notification
- IPv6 IP address/NTP/DNS management
- Built-in Trivial File Transfer Protocol (TFTP) client
- BOOTP and DHCP for IP address assignment
- System Maintenance
 - Firmware upload/download via HTTP/TFTP
 - Reset button for system reboot or reset to factory default
 - Dual images
- DHCP Relay and DHCP Option 82
- DHCP Server
- User Privilege levels control
- NTP (Network Time Protocol)
- Network Diagnostic
 - ICMPv6/ICMPv4 remote ping
 - Cable diagnostic technology provides the mechanism to detect and report potential cabling issues
- SMTP/Syslog remote alarm
- System Log
- PLANET Smart Discovery Utility for deployment management
- Smart fan with speed control

Redundant Power System

- Redundant 100~240V AC/36-60V DC dual power
- Active-active redundant power failure protection
- Backup of catastrophic power failure on one supply
- Fault tolerance and resilience

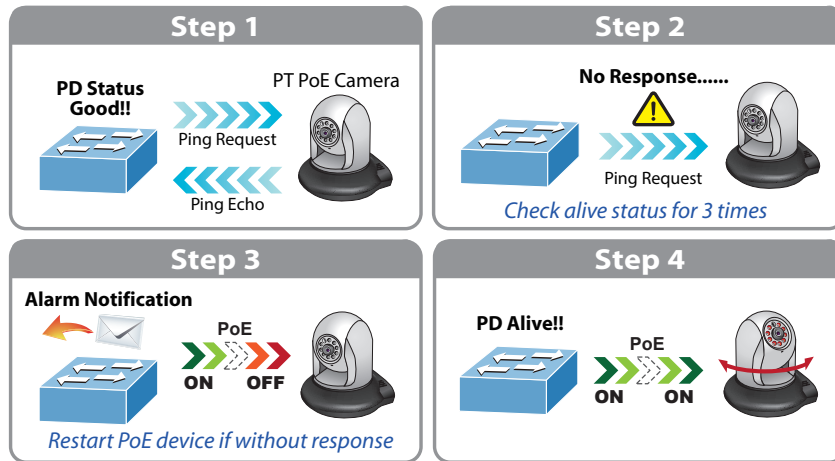

Scheduled Power Recycling

The GS-6320-24UP2T2XV allows each of the connected PoE IP cameras or PoE wireless access points to reboot at a specified time each week. Therefore, they will reduce the chance of IP camera or AP crash resulting from buffer overflow.

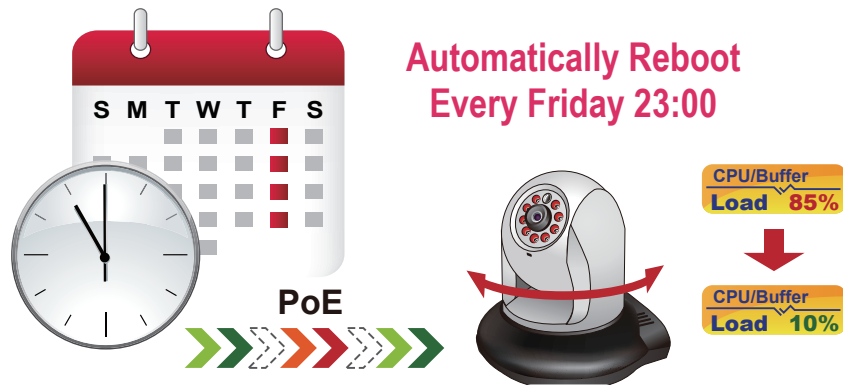

PoE Schedule for Energy Saving

Under the trend of energy saving worldwide and contributing to environmental protection, the GS-6320-24UP2T2XV can effectively control the power supply besides their capability of giving high watts power. The “PoE schedule” function helps you to enable or disable PoE power feeding for each PoE port during specified time intervals and it is a powerful function to help SMBs or enterprises save power and money. It also increases security by powering off PDs that should not be in use during non-business hours.

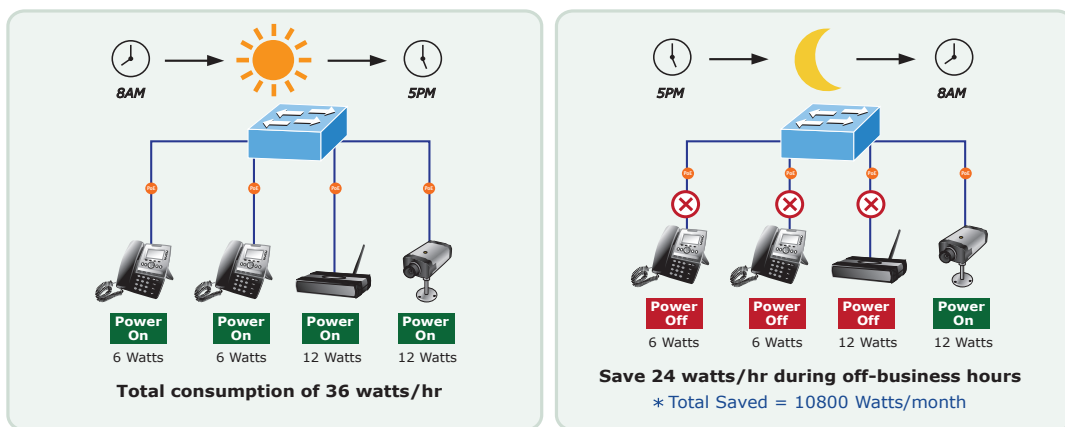

PoE Usage Monitoring

Via the power usage chart in the web management interface, the GS-6320-24UP2T2XV enables the administrator to monitor the status of the power usage of the connected PDs in real time. Thus, it greatly enhances the management efficiency of the facilities.

Cost-effective 10Gbps Uplink Capacity

10G Ethernet is a big leap in the evolution of Ethernet. The two 10G SFP+ slots of the GS-6320-24UP2T2XV support **dual-speed 10GBASE-SR/LR or 1000BASE-SX/LX**, meaning the administrator now can flexibly choose the suitable SFP/SFP+ transceiver according to the transmission distance or the transmission speed required to extend the network efficiently. They greatly support SMB network to achieve the maximum performance of 10Gbps in a cost-effective way because the 10GbE interface usually could be available in Layer 3 Switch but Layer 3 Switch could be too expensive to SMBs.

Redundant AC/DC Power Supply to Ensure Continuous Operation

The GS-6320-24UP2T2XV is particularly equipped with one 100~240V AC power supply unit and one 36~60V DC power supply unit to provide an enhanced reliable and scalable redundant power supply. The continuous power system is specifically designed to fulfill the demands of high-tech facilities requiring the highest power integrity. With the 36~60V DC power supply, the GS-6320-24UP2T2XV is able to act as a telecom-level device that can be located in the electronic room.



Environment-friendly, Smart Fan Design for Silent Operation

The GS-6320-24UP2T2XV features a 19-inch metal housing, a low noise design and an effective ventilation system. It supports the smart fan technology that automatically controls the speed of the built-in fan to reduce noise and maintain the temperature of the PoE switch for optimal power output capability. The GS-6320-24UP2T2XV is able to operate reliably, stably and quietly in any environment without affecting its performance.

Solution for IPv6 Networking

By supporting IPv6/IPv4 dual stack and plenty of management functions with easy and friendly-user interfaces, the GS-6320-24UP2T2XV is the best choice for IP surveillance, VoIP and wireless service providers to deploy the IPv6 network. It also helps the SMBs to step in the IPv6 era with the lowest investment but not necessary to replace the network facilities while the ISPs construct the IPv6 FTTx edge network.

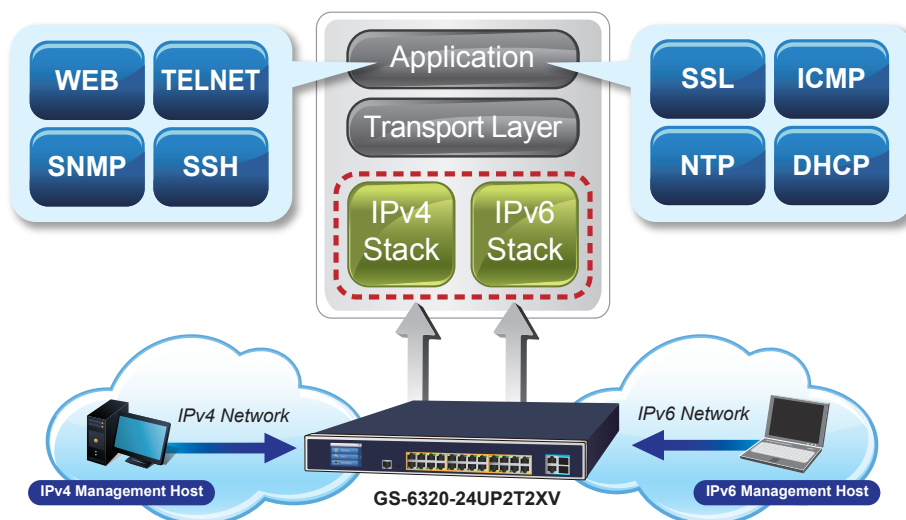

IPv4 and IPv6 VLAN Routing for Secure and Flexible Management

To help customers stay on top of their businesses, the GS-6320-24UP2T2XV not only provides ultra high transmission performance and excellent Layer 2 technologies, but also offers IPv4/IPv6 VLAN routing feature which allows to cross over different VLANs and different IP addresses for the purpose of having a highly-secure, flexible management and simpler networking application.

Robust Layer 2 Features

The GS-6320-24UP2T2XV can be programmed for advanced switch management functions, such as dynamic port link aggregation, **Q-in-Q VLAN**, **Multiple Spanning Tree Protocol (MSTP)**, Layer 2/4 QoS, bandwidth control and **IGMP/MLD snooping**. The GS-6320-24UP2T2XV allows the operation of a high-speed trunk combining multiple ports. It consists of a maximum of 14 trunk groups with 4 ports for each group, and supports connection fail-over as well.

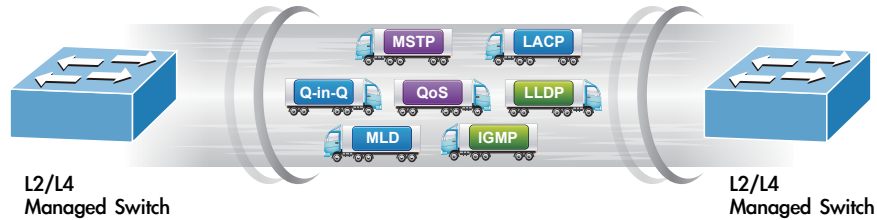

Powerful Security

The GS-6320-24UP2T2XV offers a comprehensive **Layer 2 to Layer 4 access control list (ACL)** for enforcing security to the edge. It can be used to restrict to network access by denying packets based on source and destination IP address, TCP/UDP port number or defined typical network applications. Its protection mechanism also comprises **802.1x Port-based** and **MAC-based** user and device authentication. With the **private VLAN** function, communication between edge ports can be prevented to ensure user privacy.

Enhanced Security and Traffic Control

The GS-6320-24UP2T2XV also provides **DHCP Snooping**, **IP Source Guard** and **Dynamic ARP Inspection** functions to prevent IP snooping from attack and discard ARP packets with invalid MAC address. The network administrator can now construct highly-secure corporate networks with considerably less time and effort than before.

User-friendly Secure Management

For efficient management, the GS-6320-24UP2T2XV is equipped with console, web and SNMP management interfaces. With the built-in web-based management interface, the GS-6320-24UP2T2XV offers an easy-to-use, platform independent management and configuration facility. The GS-6320-24UP2T2XV supports SNMP and it can be managed via any management software based on the standard SNMP v1 or v2 Protocol. For reducing product learning time, the GS-6320-24UP2T2XV offers Cisco-like command via Telnet or console port and customer doesn't need to learn new command from these switches. Moreover, the GS-6320-24UP2T2XV offers the remotely secure management by supporting **SSH**, **SSL** and **SNMP v3** connection where the packet content can be encrypted at each session.

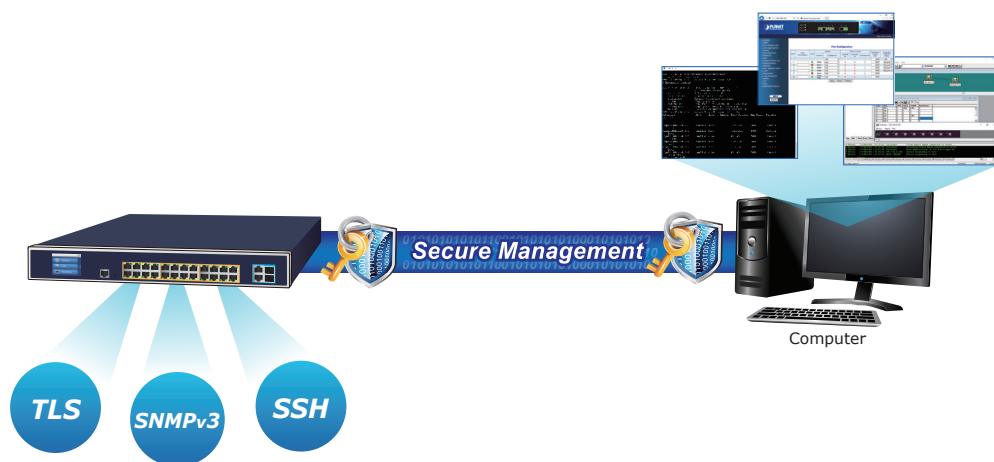

Intelligent SFP/SFP+ Diagnosis Mechanism

The GS-6320-24UP2T2XV supports **SFP-DDM (Digital Diagnostic Monitor)** function that greatly helps network administrator to easily monitor real-time parameters of the SFP and SFP+ transceivers, such as optical output power, optical input power, temperature, laser bias current, and transceiver supply voltage.

Digital Diagnostic Monitor (DDM)

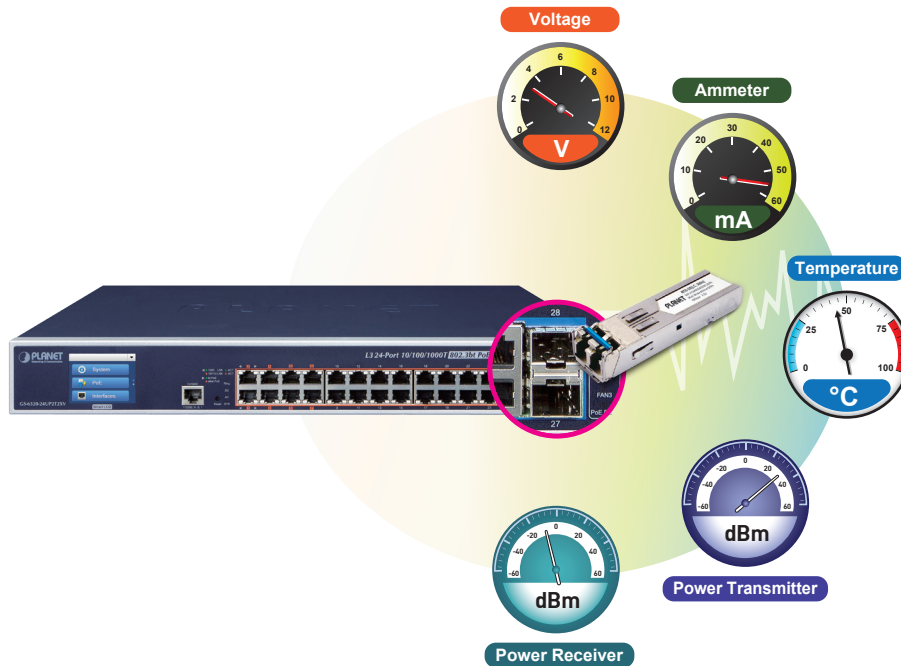

Applications

IEEE 802.3bt/ Ultra PoE Networking Solution

PLANET GS-6320-24UP2T2XV can easily build an ultra PoE networking solution on the cyber security system for the enterprises. For instance, it can work with the POS system and thin client to perform comprehensive security protection for today's businesses. The GS-6320-24UP2T2XV and POE-171S/IPOE-171S Ultra PoE Splitter operate as a pair to provide the easiest way to power your Ethernet devices which need high power input. Receiving data and power from the GS-6320-24UP2T2XV, the POE-171S/IPOE-171S separates digital data and power into several optional outputs (12V, 19V or 24V DC) to non-PoE devices such as laptops, thin client, POS system, PTZ (pan, tilt & zoom) network cameras, PTZ speed dome cameras, color touch-screen IP phones, multi-channel wireless LAN access points and other network devices at distance up to 100 meters.

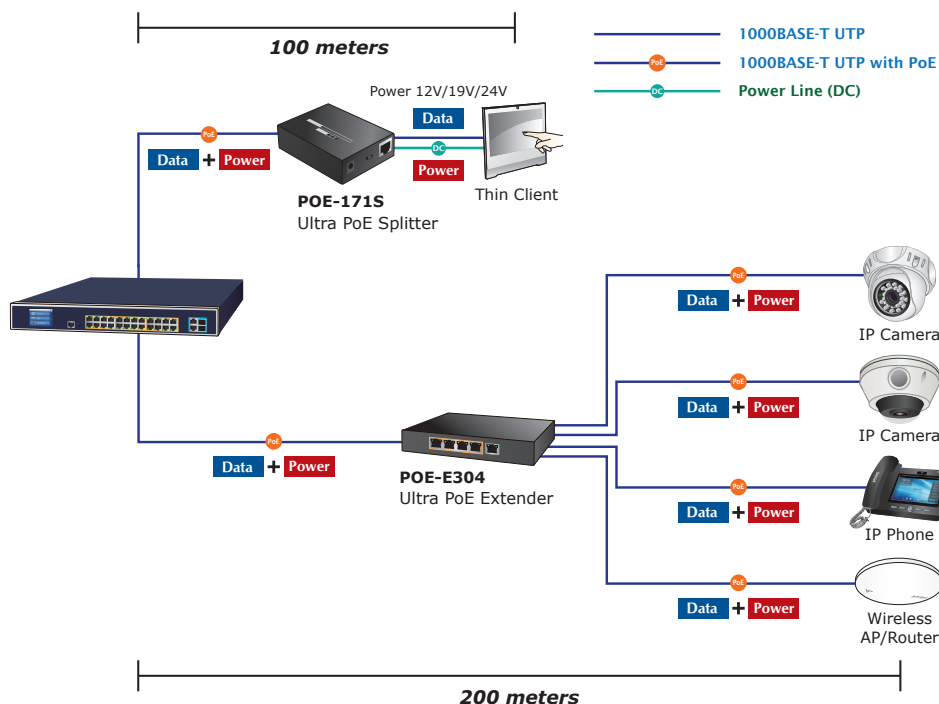

Optimal Redundant Ring for Faster Recovery of Managed Network

The GS-6320-24UP2T2XV supports redundant ring technology and features strong, rapid self-recovery capability to prevent interruptions and external intrusions. It incorporates advanced ITU-T G.8032 ERPS (Ethernet Ring Protection Switching) technology, and Spanning Tree Protocol (802.1w RSTP) into customer's network to enhance system reliability and uptime in harsh environments. In a certain simple ring network, the recovery time could be less than 50ms to quickly bring the network back, thus enabling the management network to keep on operating.

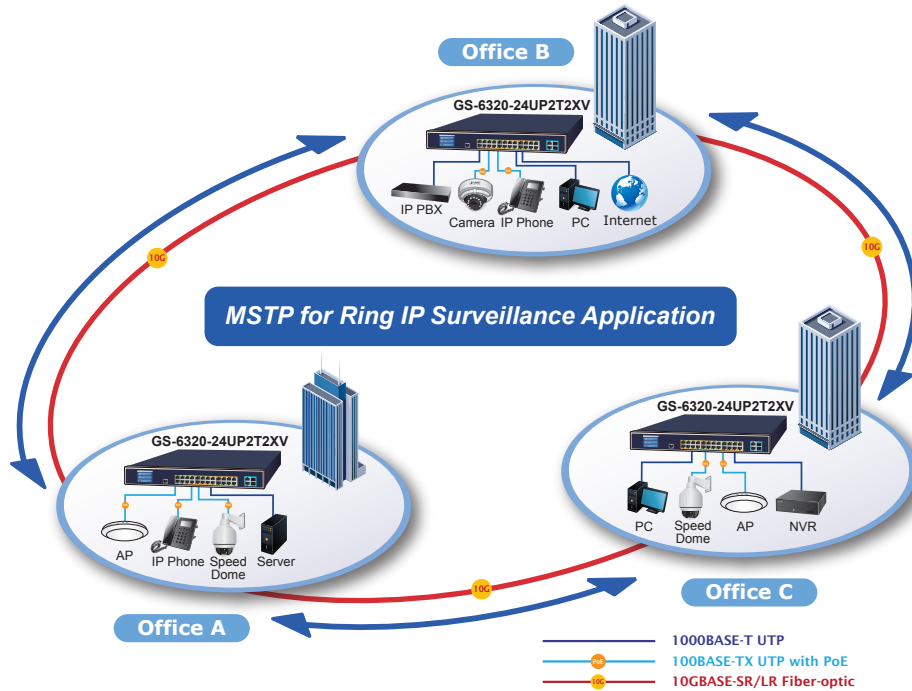

Specifications

Product	GS-6320-24UP2T2XV
Hardware Specifications	
Copper Ports	24 10/100/1000BASE-T RJ45 auto-MDI/MDI-X ports 2 10GBASE-T RJ45 ports auto negotiation (Port-25 to Port-26), supports 10G/5G/2.5G/1G/100Mbps data rate
SFP+ Slots	2 10GBASE-SR/LR SFP+ interfaces (Port-27 to Port-28) Compatible with 1000BASE-SX/LX/BX SFP transceiver
Console	1 x RS232-to-RJ45 serial port (115200, 8, N, 1)
Switch Architecture	Store-and-Forward
Switch Fabric	128Gbps/non-blocking
Throughput	95.23Mpps@64Bytes
Address Table	16K entries, automatic source address learning and aging
Shared Data Buffer	32M bits
Flow Control	IEEE 802.3x pause frame for full duplex Back pressure for half duplex
RING	Support ERPS, complies with ITU-T G.8032 Recovery time < 50ms
Jumbo Frame	10K bytes
Reset Button	< 5 sec: System reboot > 5 sec: Factory default
Dimensions (W x D x H)	440x300x56mm, 1.25U height
Weight	5478g
LED	System: SYS (Green) AC (Green) DC (Green) Ring (Green) Fan1/2/3 Alert (Red) PoE PWR Alert (Red) PoE Ethernet Interfaces (Port-1 to Port-24): af/at PoE (Orange) bt PoE/UPOE (Green) 1000 LNK/ACT (Green), 10/100 LNK/ACT (Orange) 1/10G SFP+ Interfaces (Port-27 and Port-28): 1G (Green), 10G (Orange)
Power Consumption	Max. 740 watts/ 2538.94 BTU
Power Requirements – AC	AC 100~240V, 50/60Hz, 8A
Power Requirements – DC	DC 36~60V, 2A
ESD Protection	6KV DC
Fan	3 smart fans
Network Cables	10G/5G/2.5G/1G/100M BASE-T: - 10G – Cat 6A/7 - 5G – Cat 6/6A/7 - 1G/2.5G – Cat 5e/6/6A/7 - 100M – Cat 5/5e/6/6A/7 - Cat 5/5e/6/6A/7 UTP cable (maximum 100 meters) 10GBASE-LR/SR/BX: - 50/125µm or 62.5/125µm multi-mode fiber optic cable, up to 300m - 9/125µm single-mode fiber optic cable, up to 60km
Power over Ethernet	
PoE Standard	802.3bt PoE++ PSE Backward compatible with IEEE 802.3af/802.3at PoE PSE
PoE Power Supply Type	<ul style="list-style-type: none"> ■ 802.3bt ■ UPoE ■ End-span ■ Mid-span ■ Force
Port Status	Per port 52V DC - 802.3bt Type-4 mode, Port-1 to Port-8: maximum 90 watts - 802.3bt Type-3 mode, Port-9 to Port-24: maximum 60 watts - UPoE mode, Port-1 to Port-8: maximum 95 watts - UPoE-mode, Port-9 to Port-24: maximum 72 watts - End-span mode: maximum 36 watts - Mid-span mode: maximum 36 watts - Force mode: maximum 60 watts
Power Pin Assignment	<ul style="list-style-type: none"> ■ 802.3bt: 1/2(-), 3/6(+), 4/5(+), 7/8(-) ■ UPoE: 1/2(-), 3/6(+), 4/5(+), 7/8(-) ■ End-span: 1/2(-), 3/6(+) ■ Mid-span: 4/5(+), 7/8(-)
PoE Power Budget	600 watts (max.)

Number of 90w 802.3bt Type-4 PDs	6	
Number of 60w 802.3bt Type-3 PDs	10	
Number of 802.3at PDs	20	
Layer 2 Management Functions		
Port Configuration	Port disable/enable Auto-negotiation 10/100/1000Mbps full and half duplex mode selection Flow control disable/enable	
Port Status	Display each port's speed duplex mode, link status, flow control status,	
Port Mirroring	TX/RX/Both Many-to-1 monitor	
VLAN	802.1Q tagged VLAN Q-in-Q tunneling Private VLAN Edge (PVE) MAC-based VLAN Protocol-based VLAN Voice VLAN MVR (Multicast VLAN registration) Up to 255 VLAN groups, out of 4095 VLAN IDs	
Link Aggregation	IEEE 802.3ad LACP/static trunk 26 trunk groups with 4 ports per trunk	
Spanning Tree Protocol	IEEE 802.1D Spanning Tree Protocol (STP) IEEE 802.1w Rapid Spanning Tree Protocol (RSTP) IEEE 802.1s Multiple Spanning Tree Protocol (MSTP)	
QoS	Traffic classification based, strict priority and WRR 8-level priority for switching: - Port number - 802.1p priority - 802.1Q VLAN tag - DSCP/ToS field in IP packet	
IGMP Snooping	IPv4 IGMP (v1/v2/v3) snooping, up to 255 multicast groups IPv4v4 IGMP querier mode support	
MLD Snooping	IPv6 MLD (v1/v2) snooping, up to 255 multicast groups IPv6 MLD querier mode support	
Access Control List	IP-based ACL/MAC-based ACL Up to 256 entries	
Bandwidth Control	Per port bandwidth control Ingress: 100Kbps~1000Mbps Egress: 100Kbps~1000Mbps	
Layer 3 Functions		
IP Interfaces	Max. 128 VLAN interfaces	
Routing Table	Max. 128 routing entries	
Routing Protocols	IPv4 OSPFv2 IPv4 hardware static routing IPv6 hardware static routing	
Management		
Basic Management Interfaces	Console; Telnet; Web browser; SNMP v1, v2c	
Secure Management Interfaces	SSHv1/SSHv2, TLS, SSL, SNMP v3	
SNMP MIBs	RFC 1213 MIB-II RFC 1493 Bridge MIB RFC 1643 Ethernet MIB RFC 2863 Interface MIB RFC 2665 Ether-Like MIB RFC 2819 RMON MIB (Groups 1, 2, 3 and 9) RFC 2737 Entity MIB RFC 2618 RADIUS Client MIB RFC 2863 IF-MIB	RFC 2933 IGMP-STD-MIB RFC 3411 SNMP-Frameworks-MIB RFC 4292 IP Forward MIB RFC 4293 IP MIB RFC 4836 MAU-MIB IEEE 802.1X PAE LLDP MAU-MIB
Standards Conformance		
Regulatory Compliance	FCC Part 15 Class A, CE	
Standards Compliance	IEEE 802.3 10BASE-T IEEE 802.3u 100BASE-TX/100BASE-FX IEEE 802.3z Gigabit SX/LX IEEE 802.3ab Gigabit 1000T IEEE 802.3ae 10Gb/s Ethernet IEEE 802.3x flow control and back pressure IEEE 802.3ad port trunk with LACP IEEE 802.1D Spanning Tree Protocol IEEE 802.1w Rapid Spanning Tree Protocol IEEE 802.1s Multiple Spanning Tree Protocol IEEE 802.1p Class of Service IEEE 802.1Q VLAN tagging IEEE 802.1x Port Authentication Network Control IEEE 802.1ab LLDP IEEE 802.3af Power over Ethernet	IEEE 802.3at Power over Ethernet Plus IEEE 802.3bt PoE++ RFC 768 UDP RFC 793 TFTP RFC 791 IP RFC 792 ICMP RFC 2068 HTTP RFC 1112 IGMP v1 RFC 2236 IGMP v2 RFC 3376 IGMP v3 RFC 2710 MLD v1 RFC 3810 MLD v2 RFC 2328 OSPF v2 ITU G.8032 ERPS Ring ITU-T G.8032 ERPS Ring

Environment

Operating	Temperature: 0 ~ 50 degrees C Relative Humidity: 5 ~ 95% (non-condensing)
Storage	Temperature: -10 ~ 70 degrees C Relative Humidity: 5 ~ 95% (non-condensing)

Drawing

■ GS-6320-24UP2T2XV

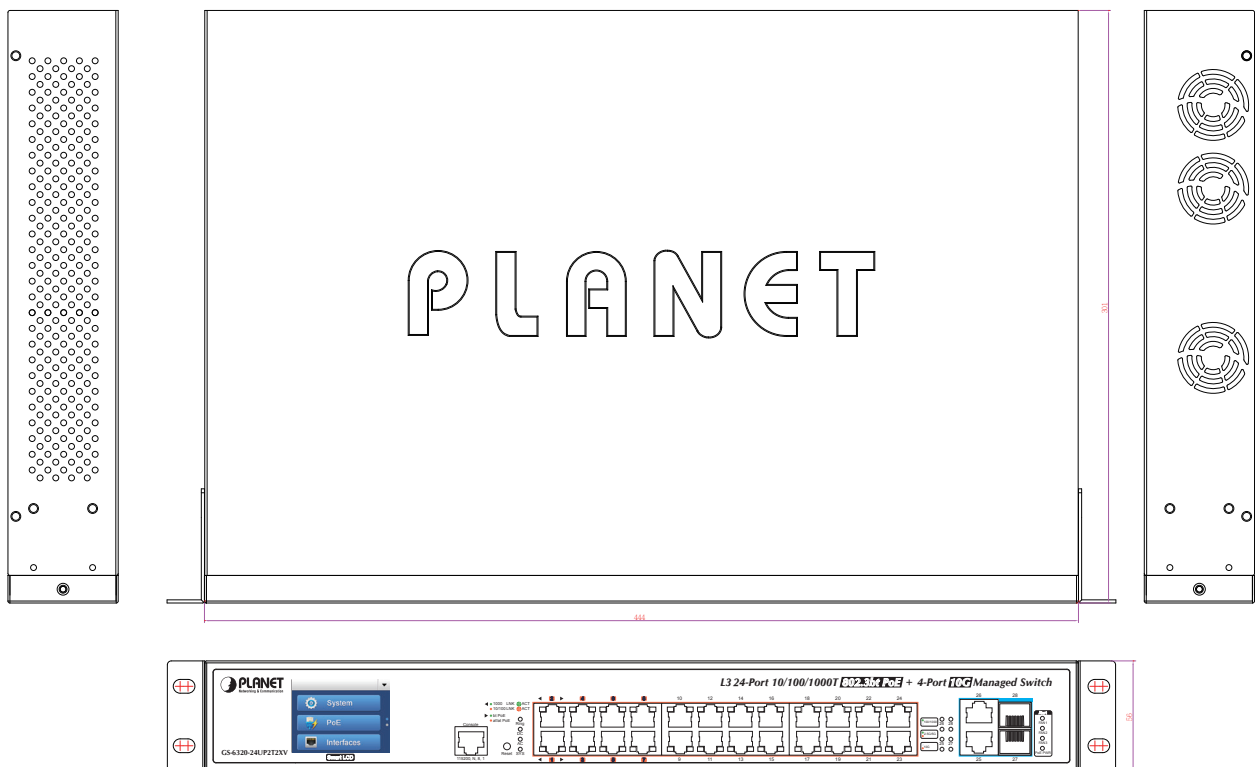

Unit : mm

Ordering Information

GS-6320-24UP2T2XV	L3 24-Port 10/100/1000T 802.3bt PoE + 2-Port 10GBEAS-T + 2-Port 10G SFP+ Managed Switch with LCD Touch Screen and Redundant Power
-------------------	---

Related Products

GS-5220-24UP4XV	L2+ 24-Port 10/100/1000T Ultra PoE + 4-Port 10G SFP+ Managed Switch with LCD Touch Screen (400W)
GS-5220-24UP4XVR	L2+ 24-Port 10/100/1000T Ultra PoE + 4-Port 10G SFP+ Managed Switch with LCD Touch Screen and Redundant Power (400W)
GS-5220-24UPL4XV	L2+ 24-Port 10/100/1000T Ultra PoE + 4-Port 10G SFP+ Managed Switch with LCD Touch Screen (600W)
GS-5220-24UPL4XVR	L2+ 24-Port 10/100/1000T Ultra PoE + 4-Port 10G SFP+ Managed Switch with LCD Touch Screen and Redundant Power (600W)

Available Modules for GS-6320-24UP2T2XV

10Gigabit Ethernet Transceiver (10GBASE-X SFP+)

Model	Speed (Mbps)	Connector Interface	Fiber Mode	Distance	Wavelength (nm)	Operating Temp.
MTB-RJ	10G	Copper	--	30m	--	0 ~ 70 degrees C
MTB-SR	10G	LC	Multi Mode	300m	850nm	0 ~ 60 degrees C
MTB-LR	10G	LC	Single Mode	10km	1310nm	0 ~ 60 degrees C
MTB-TSR	10G	LC	Multi Mode	300m	850nm	-40 ~ 75 degrees C
MTB-TLR	10G	LC	Single Mode	10km	1310nm	-40 ~ 75 degrees C

10Gigabit Ethernet Transceiver (10GBASE-BX, Single Fiber Bi-directional SFP)

Model	Speed (Mbps)	Connector Interface	Fiber Mode	Distance	Wavelength (TX)	Wavelength (RX)	Operating Temp.
MTB-LA20	10G	WDM(LC)	Single Mode	20km	1270nm	1330nm	0 ~ 60 degrees C
MTB-LB20	10G	WDM(LC)	Single Mode	20km	1330nm	1270nm	0 ~ 60 degrees C
MTB-LA40	10G	WDM(LC)	Single Mode	40km	1270nm	1330nm	0 ~ 60 degrees C
MTB-LB40	10G	WDM(LC)	Single Mode	40km	1330nm	1270nm	0 ~ 60 degrees C
MTB-LA60	10G	WDM(LC)	Single Mode	60km	1270nm	1330nm	0 ~ 60 degrees C
MTB-LB60	10G	WDM(LC)	Single Mode	60km	1330nm	1270nm	0 ~ 60 degrees C

Gigabit Ethernet Transceiver (1000BASE-X SFP)

Model	DDM	Speed (Mbps)	Connector Interface	Fiber Mode	Distance	Wavelength (nm)	Operating Temp.
MGB-GT	--	1000	Copper	--	100m	--	0 ~ 60 degrees C
MGB-SX(V2)	YES	1000	LC	Multi Mode	550m	850nm	0 ~ 60 degrees C
MGB-SX2(V2)	YES	1000	LC	Multi Mode	2km	1310nm	0 ~ 60 degrees C
MGB-LX(V2)	YES	1000	LC	Single Mode	20km	1310nm	0 ~ 60 degrees C
MGB-L40	YES	1000	LC	Single Mode	40km	1310nm	0 ~ 60 degrees C
MGB-L80	YES	1000	LC	Single Mode	80km	1550nm	0 ~ 60 degrees C
MGB-L120(V2)	YES	1000	LC	Single Mode	120km	1550nm	0 ~ 60 degrees C
MGB-TSX	YES	1000	LC	Multi Mode	550m	850nm	-40 ~ 75 degrees C
MGB-TSX2	YES	1000	LC	Multi Mode	2km	1310nm	-40 ~ 75 degrees C
MGB-TLX(V2)	YES	1000	LC	Single Mode	20km	1310nm	-40 ~ 75 degrees C
MGB-TL40	YES	1000	LC	Single Mode	40km	1310nm	-40 ~ 75 degrees C
MGB-TL80	YES	1000	LC	Single Mode	80km	1550nm	-40 ~ 75 degrees C

Gigabit Ethernet Transceiver (1000BASE-BX, Single Fiber Bi-directional SFP)

Model	DDM	Speed (Mbps)	Connector Interface	Fiber Mode	Distance	Wavelength (TX)	Wavelength (RX)	Operating Temp.
MGB-LA10(V2)	YES	1000	WDM(LC)	Single Mode	10km	1310nm	1550nm	0 ~ 60 degrees C
MGB-LB10(V2)		1000	WDM(LC)	Single Mode	10km	1550nm	1310nm	0 ~ 60 degrees C
MGB-LA20(V2)	YES	1000	WDM(LC)	Single Mode	20km	1310nm	1550nm	0 ~ 60 degrees C
MGB-LB20(V2)		1000	WDM(LC)	Single Mode	20km	1550nm	1310nm	0 ~ 60 degrees C
MGB-LA40(V2)	YES	1000	WDM(LC)	Single Mode	40km	1310nm	1550nm	0 ~ 60 degrees C
MGB-LB40(V2)		1000	WDM(LC)	Single Mode	40km	1550nm	1310nm	0 ~ 60 degrees C
MGB-LA80	YES	1000	WDM(LC)	Single Mode	80km	1490nm	1550nm	0 ~ 60 degrees C
MGB-LB80		1000	WDM(LC)	Single Mode	80km	1550nm	1490nm	0 ~ 60 degrees C
MGB-TLA10(V2)	YES	1000	WDM(LC)	Single Mode	10km	1310nm	1550nm	-40 ~ 75 degrees C
MGB-TLB10(V2)		1000	WDM(LC)	Single Mode	10km	1550nm	1310nm	-40 ~ 75 degrees C
MGB-TLA20	YES	1000	WDM(LC)	Single Mode	20km	1310nm	1550nm	-40 ~ 75 degrees C
MGB-TLB20		1000	WDM(LC)	Single Mode	20km	1550nm	1310nm	-40 ~ 75 degrees C
MGB-TLA40	YES	1000	WDM(LC)	Single Mode	40km	1310nm	1550nm	-40 ~ 75 degrees C
MGB-TLB40		1000	WDM(LC)	Single Mode	40km	1550nm	1310nm	-40 ~ 75 degrees C
MGB-TLA80	YES	1000	WDM(LC)	Single Mode	80km	1490nm	1550nm	-40 ~ 75 degrees C
MGB-TLB80		1000	WDM(LC)	Single Mode	80km	1550nm	1490nm	-40 ~ 75 degrees C

Fast Ethernet Transceiver (100BASE-X SFP)

Model	Speed (Mbps)	Connector Interface	Fiber Mode	Distance	Wavelength (nm)	Operating Temp.
MFB-FX	100	LC	Multi Mode	2km	1310nm	0 ~ 60 degrees C
MFB-F20	100	LC	Single Mode	20km	1310nm	0 ~ 60 degrees C
MFB-F40	100	LC	Single Mode	40km	1310nm	0 ~ 60 degrees C
MFB-F60	100	LC	Single Mode	60km	1310nm	0 ~ 60 degrees C
MFB-F120	100	LC	Single Mode	120km	1310nm	0 ~ 60 degrees C
MFB-TFX	100	LC	Multi Mode	2km	1310nm	-40 ~ 75 degrees C
MFB-TF20	100	LC	Single Mode	20km	1310nm	-40 ~ 75 degrees C

Fast Ethernet Transceiver (100BASE-BX, Single Fiber Bi-directional SFP)

Model	Speed (Mbps)	Connector Interface	Fiber Mode	Distance	Wavelength (TX)	Wavelength (RX)	Operating Temp.
MFB-FA20	100	WDM(LC)	Single Mode	20km	1310nm	1550nm	0 ~ 60 degrees C
MFB-FB20	100	WDM(LC)	Single Mode	20km	1550nm	1310nm	0 ~ 60 degrees C
MFB-TSA	100	WDM(LC)	Multi Mode	2km	1310nm	1550nm	-40 ~ 75 degrees C
MFB-TSB	100	WDM(LC)	Multi Mode	2km	1550nm	1310nm	-40 ~ 75 degrees C
MFB-TFA20	100	WDM(LC)	Single Mode	20km	1310nm	1550nm	-40 ~ 75 degrees C
MFB-TFB20	100	WDM(LC)	Single Mode	20km	1550nm	1310nm	-40 ~ 75 degrees C
MFB-TFA40	100	WDM(LC)	Single Mode	40km	1310nm	1550nm	-40 ~ 75 degrees C
MFB-TFB40	100	WDM(LC)	Single Mode	40km	1550nm	1310nm	-40 ~ 75 degrees C