

2-Port 10/100/1000T 802.3bt PoE + 6-Port 10/100/1000T 802.3at PoE + 2-Port 100/1000X SFP Managed Switch



IEEE 802.3bt PoE++ Managed Switch with Advanced L2/L4 Switching and Security

PLANET GS-4210-8HP2S is a cost-optimized 1U Gigabit IEEE 802.3bt PoE++ Managed Switch featuring PLANET intelligent PoE functions to improve the availability of critical business applications. It provides IPv6/IPv4 dual stack management and built-in L2/L4 Gigabit switching engine along with 2 10/100/1000BASE-T ports featuring 95-watt 802.3bt PoE++, 6 10/100/1000BASE-T ports featuring 30-watt 802.3at PoE+ and 2 100/1000BASE-X SFP ports. With a total power budget of up to 240 watts for different kinds of PoE applications, the GS-4210-8HP2S provides a quick, safe and cost-effective 802.3bt PoE++ network solution for small businesses and enterprises.



GS-4210-8HP2S

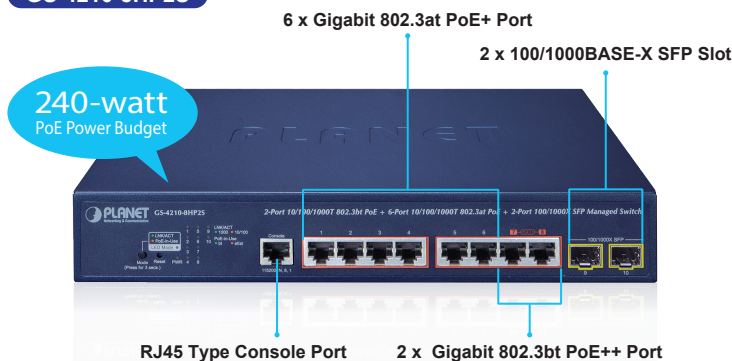

Physical Port

- 8-port 10/100/1000BASE-T RJ45 copper with PoE injector function
- 2 100/1000BASE-X mini-GBIC/SFP slots
- RJ45 console interface for switch basic management and setup

Switching

- Hardware-based 10/100Mbps, half/full duplex and 1000Mbps full duplex mode, flow control and auto-negotiation, and auto MDI/MDI-X
- Features Store-and-Forward mode with wire-speed filtering and forwarding rates
- IEEE 802.3x flow control for full duplex operation and back pressure for half duplex operation
- 10K jumbo frame
- Automatic address learning and address aging
- Supports CSMA/CD protocol

Power over Ethernet

- Complies with IEEE 802.3bt PoE++ and 802.3at PoE+ standard PSE
- Backward compatible with IEEE 802.3af Power over Ethernet
- Selectable PoE mode: End-span/Mid-span/802.3bt
- Ports 1 to 6 support up to 30 watts
- Ports 7 to 8 support up to 95 watts
- Each PoE port supports 54V DC power to powered device
- 240-watt PoE budget
- Auto detects powered device
- Circuit protection prevents power interference between ports
- Remote power feeding up to 100 meters in standard mode and 250m in extended mode
- PoE management
 - Total PoE function enable/disable
 - PoE Legacy enable/disable
 - Temperature Threshold
 - PoE Usage Threshold
 - Per port PoE function enable/disable
 - PoE port power feeding priority
 - Per PoE port power limitation
 - PD classification detection
 - PoE extension
- Intelligent PoE features

Cybersecurity Network Solution to Minimize Security Risks

The cybersecurity feature included to protect the switch management in a mission-critical network virtually needs no effort and cost to install. Both SSHv2 and TLSv1.2 protocols are utilized to provide strong protection against advanced threats. The network administrator can now construct highly-secure corporate networks with considerably less time and effort than before.



Redundant Ring, Fast Recovery for Critical Network Applications

The GS-4210-8HP2S supports redundant ring technology and features strong, rapid self-recovery capability to prevent interruptions and external intrusions. It incorporates advanced ITU-T G.8032 ERPS (Ethernet Ring Protection Switching) technology, Spanning Tree Protocol (802.1s MSTP) into customer's network to enhance system reliability and uptime in various environments.

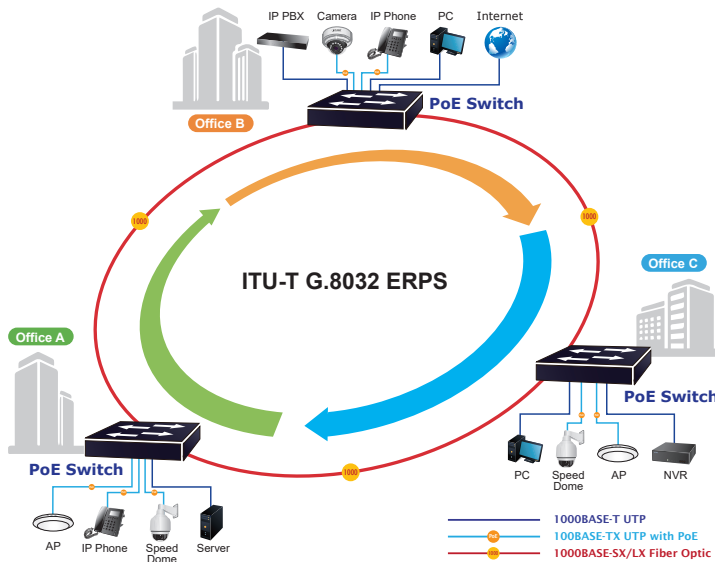

- PD alive check
- PoE schedule
- Scheduled power recycling

Layer 2 Features

- Prevents packet loss with back pressure (half-duplex) and IEEE 802.3x pause frame flow control (full-duplex)
- High performance Store and Forward architecture, broadcast storm control, and runt/CRC filtering that eliminates erroneous packets to optimize the network bandwidth
- Supports **VLAN**
 - IEEE 802.1Q tagged VLAN
 - Provider Bridging (VLAN Q-in-Q) support (IEEE 802.1ad)
 - Protocol VLAN
 - Voice VLAN
 - Private VLAN
 - Management VLAN
 - GVRP
- Supports **Spanning Tree Protocol**
 - STP (Spanning Tree Protocol)
 - RSTP (Rapid Spanning Tree Protocol)
 - MSTP (Multiple Spanning Tree Protocol)
 - STP BPDU Guard, BPDU filtering and BPDU forwarding
- Supports **Link Aggregation**
 - IEEE 802.3ad Link Aggregation Control Protocol (LACP)
 - Cisco ether-channel (static trunk)
- Provides port mirror (many-to-1)
- Loop protection to avoid broadcast loops
- Supports ERPS (Ethernet Ring Protection Switching)

Quality of Service

- Ingress and egress rate limit per port bandwidth control
- Storm control support
 - Broadcast/Unknown unicast/Unknown multicast
- Traffic classification
 - IEEE 802.1p CoS
 - TOS/DSCP/IP precedence of IPv4/IPv6 packets
- Strict priority and Weighted Round Robin (WRR) CoS policies

Multicast

- Supports IPv4 IGMP snooping v2 and v3
- Supports IPv6 MLD snooping v1, v2
- IGMP querier mode support
- IGMP snooping port filtering
- MLD snooping port filtering

Security

- Authentication

IEEE 802.3bt PoE++ Solutions

The GS-4210-8HP2S supports the 802.3bt standard, supplying up to 95 watts per 802.3bt port for increased requirements of devices. It can offer more PoE applications, such as:

- PoE PTZ speed dome cameras
- Any network device that needs higher PoE power to work normally
- Thin-client
- AIO (All-in-One) touch PC
- Remote digital signage display

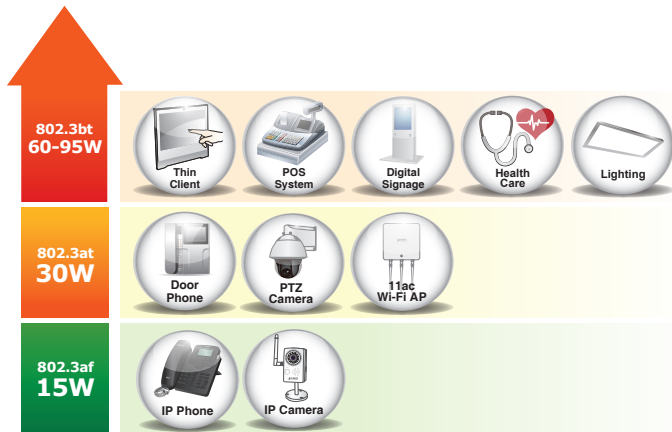

Built-in Unique PoE Functions for Powered Devices Management

Being the managed PoE switches for surveillance, wireless and VoIP networks, the GS-4210-8HP2S features the following special PoE management functions:

- PD alive check
- Scheduled power recycling
- PoE schedule
- PoE usage monitoring
- PoE extension

Intelligent Powered Device Alive Check

The GS-4210-8HP2S can be configured to monitor connected PD (Powered Device) status in real time via ping action. Once the PD stops working and responding, the GS-4210-8HP2S will resume the PoE port power and bring the PD back to work. It will greatly enhance the network reliability through the PoE port resetting the PD's power source and reducing administrator management burden.

PD Alive Check

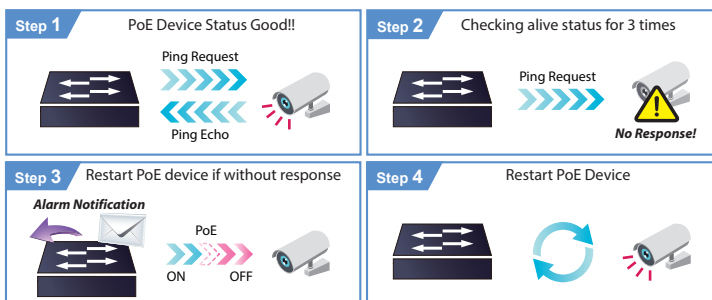

- IEEE 802.1X port-based network access authentication
- Built-in RADIUS client to cooperate with the RADIUS servers
- RADIUS/TACACS+ login user access authentication
- Access control list
 - IPv4/IPv6 IP-based ACL
 - MAC-based ACL
- MAC security
 - Static MAC
 - MAC filtering
- Port security for source MAC address entries filtering
- DHCP snooping to filter distrusted DHCP messages
- Dynamic ARP Inspection discards ARP packets with invalid MAC address to IP address binding
- IP source guard prevents IP spoofing attacks
- DoS attack prevention

Management

- IPv4 and IPv6 dual stack management
- Switch management interface
 - Web switch management
 - Console and telnet command line interface
 - SNMP v1 and v2c switch management
 - SSHv2, TLSv1.2 and SNMP v3 secure access
- SNMP Management
 - Four RMON groups (history, statistics, alarms and events)
 - SNMP trap for interface link up and link down notification
- User privilege levels control
- Built-in Trivial File Transfer Protocol (TFTP) client
- BOOTP and DHCP for IP address assignment
- System maintenance
 - Firmware upload/download via HTTP/TFTP
 - Configuration upload/download through web interface
 - Dual images
 - Hardware reset button for system reboot or reset to factory default
- SNTP Network Time Protocol
- Network Diagnostic
 - SFP-DDM (digital diagnostic monitor)
 - Cable diagnostics
 - ICMPv4/ICMPv6 remote ping
- Link Layer Discovery Protocol (LLDP) and LLDP-MED
- Event message logging to remote syslog server
- Smart fan with speed control
- PLANET Smart Discovery Utility for deployment management
- PLANET NMS system and CloudViewer/CloudViewerPro for deployment manage

Scheduled Power Recycling

The GS-4210-8HP2S allows each of the connected PoE IP cameras or PoE wireless access points to reboot at a specified time each week. Therefore, it will reduce the chance of IP camera or AP crash resulting from buffer overflow.

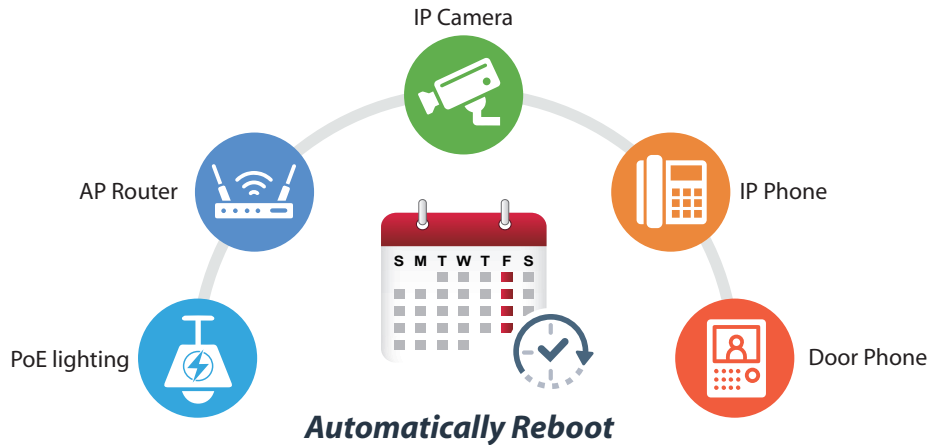

PoE Schedule for Energy Savings

Under the trend of energy savings worldwide and contributing to environmental protection, the GS-4210-8HP2S can effectively control the power supply besides its capability of giving high watts power. The “PoE schedule” function helps you to enable or disable PoE power feeding for each PoE port during specified time intervals and it is a powerful function to help SMBs or Enterprises save power and money. It also increases security by powering off PDs that should not be in use during non-business hours.

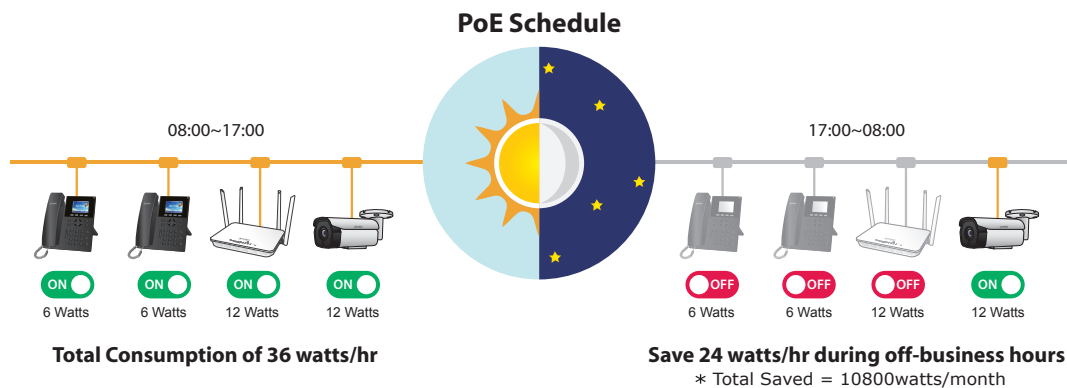

PoE Usage Monitoring

Via the power usage chart in the web management interface, the GS-4210-8HP2S enables the administrator to monitor the status of the power usage of the connected PDs in real time. Thus, it greatly enhances the management efficiency of the facilities.

PoE+ Power and Ethernet Data Transmission Distance Extension

In the “Extend” operation mode, the GS-4210-8HP2S operates on a per-port basis at 10Mbps duplex operation but can support 23- or 85-watt PoE power output correspondingly over a distance of up to 250 meters overcoming the 100m limit on Ethernet UTP cable. With this brand-new feature, the GS-4210-8HP2S provides an additional solution for 802.3af/at PoE distance extension, thus saving the cost of Ethernet cable installation.

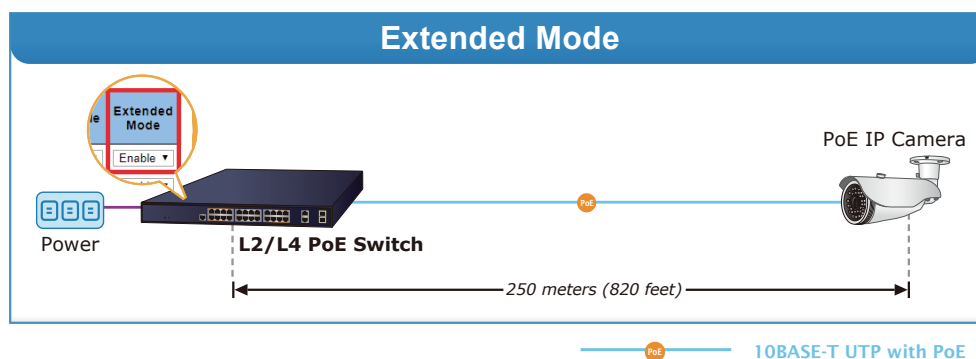

Environment-friendly, Smart Fan Design for Silent Operation

The GS-4210-8HP2S features a desktop-size metal housing, a low noise design and an effective ventilation system. It supports the smart fan technology that automatically controls the speed of the built-in fan to reduce noise and maintain the temperature of the PoE switch for optimal power output capability. The GS-4210-8HP2S is able to operate reliably, stably and quietly in any environment without affecting its performance.



IPv6/IPv4 Dual Stack Management

Supporting both IPv6 and IPv4 protocols, the GS-4210-8HP2S helps the SMBs to step in the IPv6 era with the lowest investment as its network facilities need not be replaced or overhauled if the IPv6 FTTx edge network is set up.

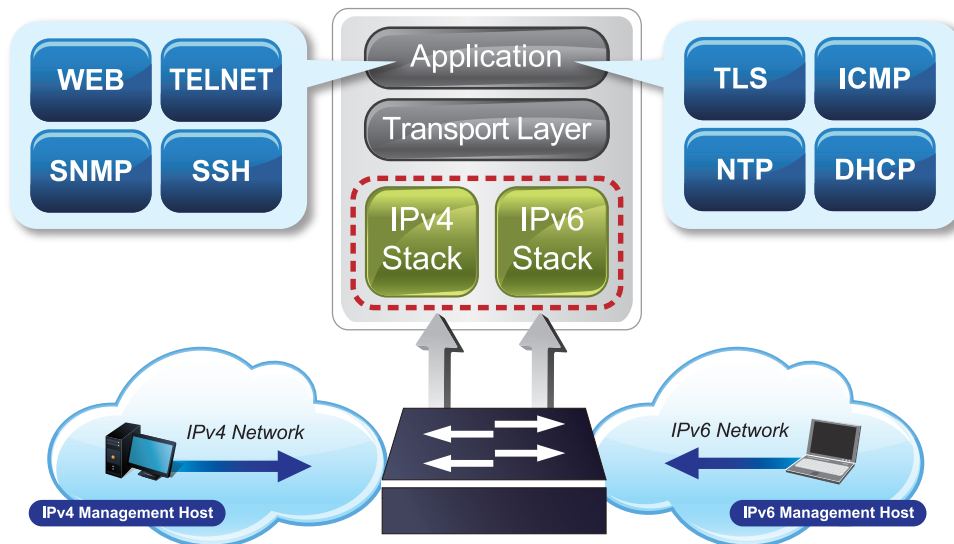

Robust Layer 2 Features

The GS-4210-8HP2S can be programmed for advanced switch management functions such as dynamic port link aggregation, 802.1Q VLAN and **Q-in-Q VLAN**, **Multiple Spanning Tree Protocol (MSTP)**, **loop and BPDU guard**, **IGMP snooping**, and **MLD snooping**. Via the link aggregation, the GS-4210-8HP2S allows the operation of a high-speed trunk to combine with multiple ports, and supports fail-over as well. Also, the **Link Layer Discovery Protocol (LLDP)** is the Layer 2 protocol included to help discover basic information about neighboring devices on the local broadcast domain.

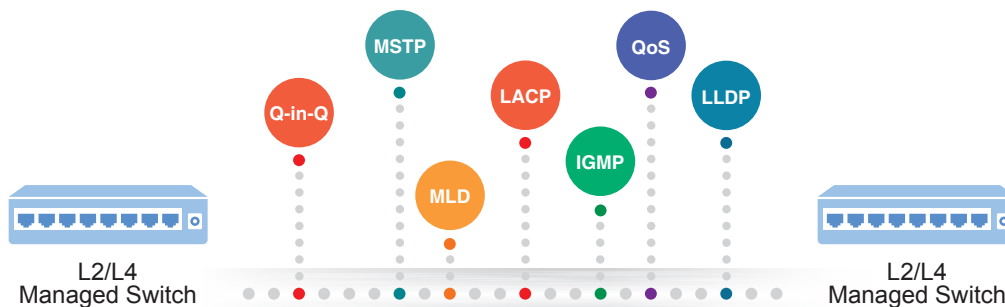

Efficient Traffic Control

The GS-4210-8HP2S is loaded with robust QoS features and powerful traffic management to enhance services to business-class data, voice and video solutions. The functionality includes broadcast/multicast **storm control**, per port **bandwidth control**, IP DSCP QoS priority and remarking. It guarantees the best performance for VoIP and video stream transmission, and empowers the enterprises to take full advantage of the limited network resources.

Powerful Security

The GS-4210-8HP2S offers comprehensive Layer 2 to Layer 4 Access Control List (ACL) for enforcing security to the edge. It can be used to restrict network access by denying packets based on source and destination IP address, TCP/UDP ports or defined typical network applications. Its protection mechanism also comprises 802.1x Port-based user authentication. With the private VLAN function, communication between edge ports can be prevented to ensure user privacy.

Advanced IP Network Protection

The GS-4210-8HP2S also provides **DHCP Snooping**, **IP Source Guard** and **Dynamic ARP Inspection** functions to prevent IP snooping from attack and discard ARP packets with invalid MAC address. The network administrator can now build highly-secure corporate networks with considerably less time and effort than before.

Efficient Management

For efficient management, the GS-4210-8HP2S is equipped with Command line, Web and SNMP management interfaces.

- With the built-in **Web-based** management interface, the GS-4210-8HP2S offers an easy-to-use, platform-independent management and configuration facility.
- For **text-based** management, it can be accessed via Telnet and the console port.
- By supporting the standard SNMP protocol, the switch can be managed via any SNMP-based management software.

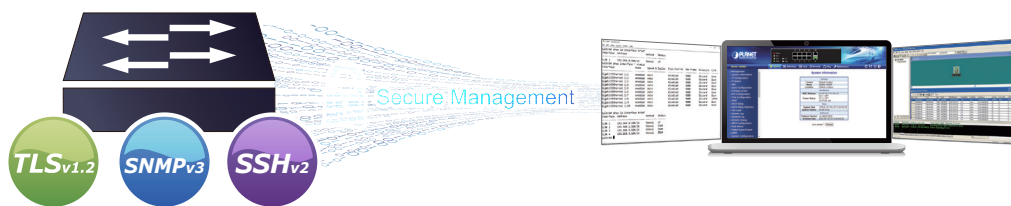

Remote Management Solution

PLANET's **Universal Network Management System (UNI-NMS)** and CloudViewer/CloudViewerPro app support IT staff by remotely managing all network devices and monitoring PDs' operational statuses. Thus, they're designed for both the enterprises and industries where deployments of PDs can be as remote as possible, without having to go to the actual location once a bug or faulty condition is found. With the UNI-NMS or CloudViewer/CloudViewerPro app, all kinds of businesses can now be speedily and efficiently managed from one platform.



Flexibility and Extension Solution

The two mini-GBIC slots built in the GS-4210-8HP2S support SFP auto-detection and dual speed as it features **100BASE-FX** and **1000BASE-SX/LX SFP** (Small Form-factor Pluggable) fiber transceivers to uplink to backbone switch and monitoring center in long distance. The distance can be extended from 550 meters to 2 kilometers (multi-mode fiber) and up to above 10/20/40/60/80/120 kilometers (single-mode fiber or WDM fiber). They are well suited for applications within the enterprise data centers and distributions.

Intelligent SFP Diagnosis Mechanism

The GS-4210-8HP2S supports **SFP-DDM (Digital Diagnostic Monitor)** function that can easily monitor real-time parameters of the SFP for network administrator, such as optical output power, optical input power, temperature, laser bias current and transceiver supply voltage.

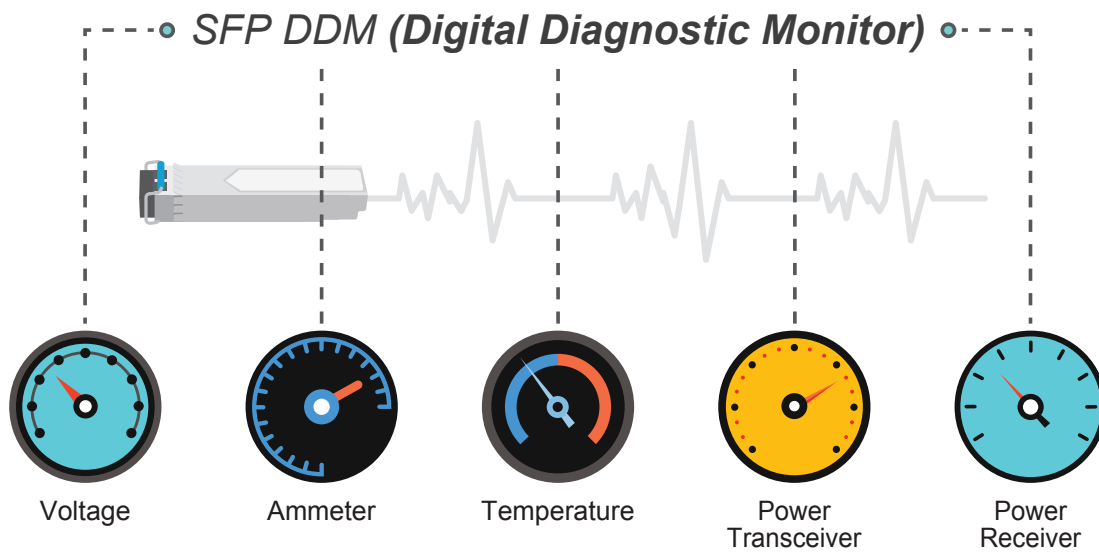

Applications

ITU-T G.8032 ERPS with PoE IP Surveillance System for SMBs/Workgroups

The GS-4210-8HP2S features strong rapid self-recovery capability to prevent interruptions and external intrusions. It incorporates **ITU-T G.8032 ERPS (Ethernet Ring Protection Switching)** technology into customer's automation network to enhance system reliability and uptime. Applying the IEEE 802.3at Power over Ethernet standard, the GS-4210-8HP2S can directly connect with any IEEE 802.3at end nodes like PTZ (pan, tilt, zoom) network cameras and speed dome cameras. The GS-4210-8HP2S can easily build a power that can centrally control a wireless AP, IP camera and VoIP system for SMBs and workgroups in the enterprises with high availability network infrastructure.

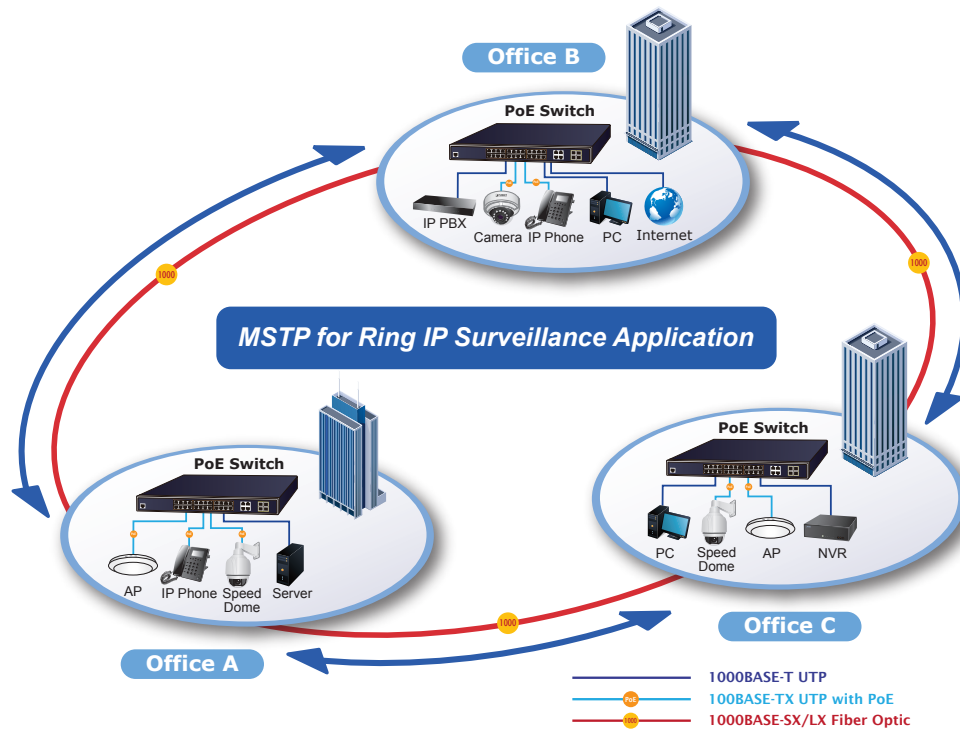

95W 802.3bt PoE++ and 30W 802.3at PoE+ Hybrid PoE Networking Solution

PLANET GS-4210-8HP2S can easily build an 802.3bt PoE++ networking solution on the cyber security system for the enterprises. For instance, it can work with the POS system and thin client to perform comprehensive security protection for today's businesses. The GS-4210-8HP2S and 802.3bt PoE++ Splitter - POE-173S, operate as a pair to provide the easiest way to power your non-PoE devices such as laptops, thin client, POS system, PTZ (pan, tilt & zoom) IP cameras and other network devices at distance up to 100 meters.

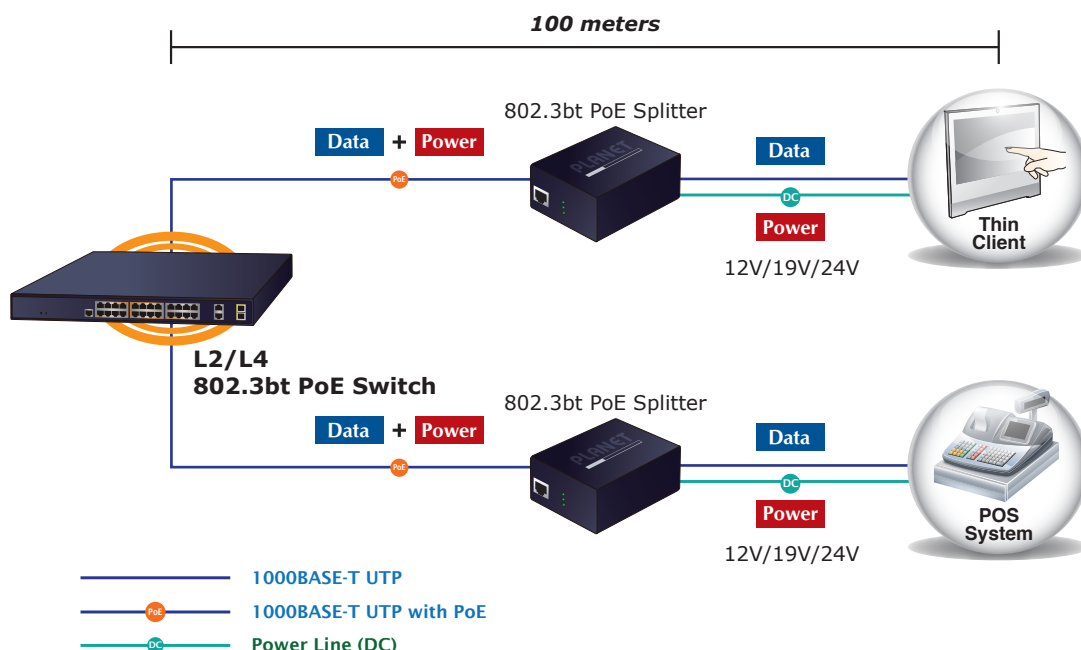

Specifications

Product	GS-4210-8HP2S
Hardware Specifications	
Copper Ports	8 x 10/100/1000BASE-T RJ45 auto-MDI/MDI-X port
SFP Slots	2 x 100/1000BASE-X SFP interface Supports 100/1000Mbps dual mode and DDM
PoE Injector Port	6 ports with 802.3at PoE+ injector function (Ports 1 to 6) 2 ports with 802.3bt PoE++ injector function (Ports 7 to 8)
Reset Button	< 5 sec: System reboot > 5 sec: Factory default
LED Indicators	PWR, LNK/ACT, PoE-in-Use, LED Mode
Power Requirements	100~240V AC, 50/60Hz, auto-sensing
Dimensions (W x D x H)	280 x 229 x 44 mm, 1U height
ESD Protection	Contact Discharge 6KV DC Air Discharge 8KV DC
Enclosure	Metal
Weight	1920g
Power Consumption/Dissipation	280 watts (max.)/2013.2 BTU
Fan	1 x smart fan Supports fanless mode
Switch Specifications	
Switch Architecture	Store-and-Forward
Switch Fabric	20Gbps/non-blocking
Switch Throughput@64Bytes	14.88Mpps
Address Table	8K entries
Shared Data Buffer	4.1 megabits
Flow Control	IEEE 802.3x pause frame for full duplex Back pressure for half duplex
Jumbo Frame	10K bytes
Power over Ethernet	
PoE Standard	IEEE 802.3af/at PoE+ PSE (Ports 1 to 6) IEEE 802.3bt PoE++ PSE (Ports 7 to 8)
PoE Power Supply Type	End-span (Ports 1 to 6) End-span/Mid-span/802.3bt (Ports 7 to 8)
PoE Power Output	Ports 1 to 6: Per PoE+ port 54V DC, max. 30 watts Ports 7 to 8: <ul style="list-style-type: none"> ■ 802.3bt mode, maximum 95 watts ■ End-span mode: maximum 30 watts ■ Mid-span mode: maximum 30 watts
Power Pin Assignment	End-span: 1/2 (-), 3/6 (+) Mid-span: 4/5 (+), 7/8 (-) 802.3bt: 1/2 (-), 3/6 (+), 4/5 (+), 7/8 (-)
PoE Power Budget	240 watts with standard mode 100 watts with fanless mode
PoE Ability PD @ 12.5 watts	8 units with standard mode 8 units with fanless mode
PoE Ability PD @ 25 watts	8 units with standard mode 4 units with fanless mode
PoE Ability PD @ 51 watts	2 units with standard mode 1 units with fanless mode
PoE Ability PD @ 71 watts	2 units with standard mode 1 units with fanless mode
PoE Management Functions	
Active PoE Device Detection	Yes
PoE Power Recycling	Yes, daily or predefined schedule
PoE Schedule	4 schedule profiles
PoE Extend Mode	Yes, max. up to 250 meters
PoE Port Management	<ul style="list-style-type: none"> ■ Port Enable/Disable/Schedule ■ PoE mode control <ul style="list-style-type: none"> - 802.3bt - 802.3at End-span - 802.3at Mid-span ■ Port Priority

Layer 2 Functions	
Port Mirroring	TX/RX/both Many-to-1 monitor Up to 4 sessions
VLAN	802.1Q tag-based VLAN Up to 256 VLAN groups, out of 4094 VLAN IDs 802.1ad Q-in-Q tunneling Voice VLAN Protocol VLAN Private VLAN (Protected port) GVRP
Link Aggregation	IEEE 802.3ad LACP and static trunk Supports 2 groups of 2-port trunk
Spanning Tree Protocol	IEEE 802.1D Spanning Tree Protocol (STP) IEEE 802.1w Rapid Spanning Tree Protocol (RSTP) IEEE 802.1s Multiple Spanning Tree Protocol (MSTP) STP BPDU Guard, BPDU Filtering and BPDU Forwarding
IGMP Snooping	IGMP (v2/v3) snooping IGMP querier Up to 256 multicast groups
MLD Snooping	MLD (v1/v2) snooping, up to 256 multicast groups
QoS	8 mapping IDs to 8 level priority queues - Port number - 802.1p priority - 802.1Q VLAN tag - DSCP field in IP packet Traffic classification based, strict priority and WRR
Ring	Supports ERPS, and complies with ITU-T G.8032
Security Functions	
Access Control List	IPv4/IPv6 IP-based ACL/MAC-based ACL
Port Security	IEEE 802.1X – Port-based authentication Built-in RADIUS client to co-operate with RADIUS server RADIUS/TACACS+ user access authentication
MAC Security	IP-MAC port binding MAC filter Static MAC address
Enhanced Security	DHCP Snooping and DHCP Option82 STP BPDU guard, BPDU filtering and BPDU forwarding DoS attack prevention ARP inspection IP source guard
Management Functions	
Basic Management Interfaces	Web browser; Telnet; SNMP v1, v2c
Secure Management Interfaces	SSHv2, TLS v1.2, SNMP v3
System Management	Firmware upgrade by HTTP/TFTP protocol through Ethernet network LLDP protocol SNTP PLANET Smart Discovery Utility PLANET NMS System and CloudViewer app
Event Management	Remote/Local Syslog System log
SNMP MIBs	RFC 1213 MIB-II RFC 1215 Generic Traps RFC 1493 Bridge MIB RFC 2674 Bridge MIB Extensions RFC 2737 Entity MIB (v2) RFC 2819 RMON (1, 2, 3, 9) RFC 2863 Interface Group MIB RFC 3635 Ethernet-like MIB RFC 3621 Power Ethernet MIB
Standards Conformance	
Regulatory Compliance	FCC Part 15 Class A, CE, LVD

Standards Compliance	<p>IEEE 802.3 10BASE-T IEEE 802.3u 100BASE-TX/100BASE-FX IEEE 802.3z Gigabit SX/LX IEEE 802.3ab Gigabit 1000T IEEE 802.3x flow control and back pressure IEEE 802.3ad port trunk with LACP IEEE 802.1D Spanning Tree Protocol IEEE 802.1w Rapid Spanning Tree Protocol IEEE 802.1s Multiple Spanning Tree Protocol IEEE 802.1p Class of Service IEEE 802.1Q VLAN tagging IEEE 802.1x Port Authentication Network Control IEEE 802.1ab LLDP IEEE 802.3af Power over Ethernet IEEE 802.3at Power over Ethernet Plus IEEE 802.3bt Power over Ethernet Plus Plus IEEE 802.3az Energy Efficient Ethernet (EEE) RFC 768 UDP RFC 783 TFTP RFC 793 TCP RFC 791 IP RFC 792 ICMP RFC 2068 HTTP RFC 1112 IGMP v1 RFC 2236 IGMP v2 RFC 3376 IGMP v3 RFC 2710 MLD v1 RFC 3810 MLD v2 ITU G.8032 ERPS Ring</p>
Environment	
Operating Temperature	<p>0~40 degrees C (Fanless mode enabled) 0~50 degrees C (Default)</p>
Storage Temperature	-20 ~ 70 degrees C
Humidity	5 ~ 95% (non-condensing)
Standard Accessories	
Packet Contents	<p>Managed Switch x 1 QIG x 1 RS232 to RJ45 Console Cable x 1 Rubber Feet x 4 Rack-mounting Package x 1 Power Cord x 1 SFP Dust Caps x 2</p>

Ordering Information

GS-4210-8HP2S	2-Port 10/100/1000T 802.3bt PoE + 6-Port 10/100/1000T 802.3at PoE + 2-Port 100/1000X SFP Managed Switch
---------------	---

Related Products

GS-4210-24HP2C	4-Port 10/100/1000T 802.3bt PoE + 20-Port 10/100/1000T 802.3at PoE + 2-Port Gigabit TP/SFP Combo Managed Switch
GS-4210-24UP4C	24-Port 10/100/1000T 802.3bt PoE++ plus 4-Port Gigabit TP/SFP Combo Managed Switch
GS-5220-8UP2T2X	Layer 3 8-Port 10/100/1000T 802.3bt PoE + 2-Port 10/100/1000T + 2-Port 10G SFP+ Managed Switch
GSD-504UP	2-Port 10/100/1000T 802.3bt PoE + 2-Port 10/100/1000T 802.3at PoE + 1-Port Gigabit Desktop Switch (External 120 Watts)
POE-173S	Single-Port 10/100/1000Mbps 802.3bt PoE++ Splitter

Available 1000Mbps Modules

Gigabit Ethernet Transceiver (1000BASE-X SFP)

Model	DDM	Speed (Mbps)	Connector Interface	Fiber Mode	Distance	Wavelength (nm)	Operating Temp.
MGB-GT	--	1000	Copper	--	100m	--	0 ~ 60 degrees C
MGB-SX(V2)	YES	1000	LC	Multi Mode	550m	850nm	0 ~ 60 degrees C
MGB-SX2(V2)	YES	1000	LC	Multi Mode	2km	1310nm	0 ~ 60 degrees C
MGB-LX(V2)	YES	1000	LC	Single Mode	20km	1310nm	0 ~ 60 degrees C
MGB-L40	YES	1000	LC	Single Mode	40km	1310nm	0 ~ 60 degrees C
MGB-L80	YES	1000	LC	Single Mode	80km	1550nm	0 ~ 60 degrees C
MGB-L120(V2)	YES	1000	LC	Single Mode	120km	1550nm	0 ~ 60 degrees C

Gigabit Ethernet Transceiver (1000BASE-BX, Single Fiber Bi-directional SFP)

Model	DDM	Speed (Mbps)	Connector Interface	Fiber Mode	Distance	Wavelength (TX)	Wavelength (RX)	Operating Temp.
MGB-LA10(V2)	YES	1000	WDM(LC)	Single Mode	10km	1310nm	1550nm	0 ~ 60 degrees C
MGB-LB10(V2)		1000	WDM(LC)	Single Mode	10km	1550nm	1310nm	0 ~ 60 degrees C
MGB-LA20(V2)	YES	1000	WDM(LC)	Single Mode	20km	1310nm	1550nm	0 ~ 60 degrees C
MGB-LB20(V2)		1000	WDM(LC)	Single Mode	20km	1550nm	1310nm	0 ~ 60 degrees C
MGB-LA40(V2)	YES	1000	WDM(LC)	Single Mode	40km	1310nm	1550nm	0 ~ 60 degrees C
MGB-LB40(V2)		1000	WDM(LC)	Single Mode	40km	1550nm	1310nm	0 ~ 60 degrees C
MGB-LA80	YES	1000	WDM(LC)	Single Mode	80km	1490nm	1550nm	0 ~ 60 degrees C
MGB-LB80		1000	WDM(LC)	Single Mode	80km	1550nm	1490nm	0 ~ 60 degrees C

Available 100Mbps Modules

Fast Ethernet Transceiver (100BASE-X SFP)

Model	Speed (Mbps)	Connector Interface	Fiber Mode	Distance	Wavelength (nm)	Operating Temp.
MFB-FX	100	LC	Multi Mode	2km	1310nm	0 ~ 60 degrees C
MFB-F20	100	LC	Single Mode	20km	1310nm	0 ~ 60 degrees C
MFB-F40	100	LC	Single Mode	40km	1310nm	0 ~ 60 degrees C
MFB-F60	100	LC	Single Mode	60km	1310nm	0 ~ 60 degrees C
MFB-F120	100	LC	Single Mode	120km	1310nm	0 ~ 60 degrees C

Fast Ethernet Transceiver (100BASE-BX, Single Fiber Bi-directional SFP)

Model	Speed (Mbps)	Connector Interface	Fiber Mode	Distance	Wavelength (TX)	Wavelength (RX)	Operating Temp.
MFB-FA20	100	WDM(LC)	Single Mode	20km	1310nm	1550nm	0 ~ 60 degrees C
MFB-FB20	100	WDM(LC)	Single Mode	20km	1550nm	1310nm	0 ~ 60 degrees C

Dimensions

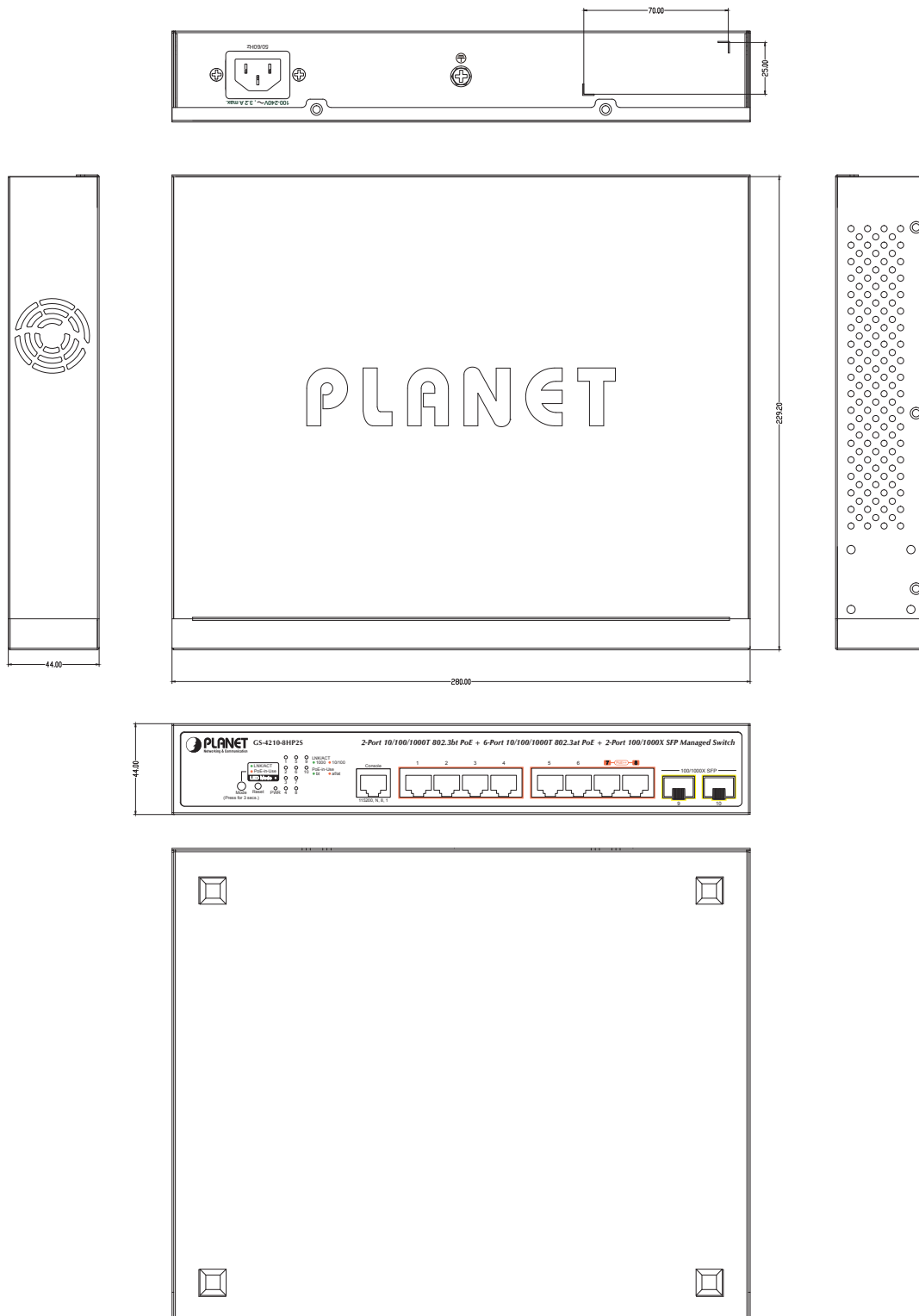

Unit: mm

PLANET Technology Corporation

11F., No.96, Minquan Rd., Xindian Dist., New Taipei City 231, Taiwan (R.O.C.)

Tel: 886-2-2219-9518

Email: sales@planet.com.tw

Fax: 886-2-2219-9528

www.planet.com.tw



PLANET reserves the right to change specifications without prior notice. All brand names and trademarks are property of their respective owners. Copyright © 2024 PLANET Technology Corp. All rights reserved.

GS-4210-8HP2S